

# TESCOM™ 44-6800 E Series Electrically Heated Vaporizing Regulator

Installation, Operations and Maintenance Manual



Do not attempt to select, install, use or maintain this product until you have read and fully understood this manual.



# Contents

<b>Chapter 1</b>	<b>Symbols.....</b>	<b>4</b>
<b>Chapter 2</b>	<b>Safety Precautions and Repair.....</b>	<b>4</b>
	2.1 44-6800E Series Regulator Safety.....	4
<b>Chapter 3</b>	<b>3. Installation, Operations and Maintenance.....</b>	<b>7</b>
	3.1 General Information.....	7
	3.1.1. Operating Parameters/Special Conditions For Safe Use.....	8
	3.2. Installation.....	9
	3.2.1. Installation Precautions.....	9
	3.3. Operation.....	12
	3.3.1 Regulator Adjustment.....	12
	3.3.2 Heater Temperature Controller Status.....	12
	3.4 Maintenance and Repair Service.....	13
	3.4.1 Repair Service.....	13
	3.4.2 Mechanical Pressure Regulator Function.....	13
	3.4.3 Electric Heater Function.....	15
<b>Chapter 4</b>	<b>4. Certifications and Warranty.....</b>	<b>16</b>
	4.1 Hazardous Location Ratings.....	16
	4.2 Declaration of Conformity.....	17
	4.3 Limited Warranty.....	18

# 1 Symbols

## **WARNING**

Paragraphs highlighted by the WARNING icon contain information about practices or circumstances that can lead to personal injury or death, property damage or economic loss.

## **CAUTION**

Paragraphs highlighted by the CAUTION icon contain information that must be followed to maintain a safe and successful operating environment.

# 2 Safety Precautions and Repair

## 2.1 44-6800E Series Regulator Safety

### **WARNING**

Do not attempt to select, install, use or maintain this regulator until you have read and fully understood these instructions. Do not permit untrained persons to install, use or maintain this regulator.

The 44-6800E Series regulator should not be installed in an enclosure that is heated above the regulator's maximum rated ambient temperature.

Be sure this information reaches the operator and stays with the product after installation.

Improper selection, improper installation, improper maintenance, misuse or abuse of regulator can cause death, serious injury and property damage.

Possible consequences include but are not limited to:

- High velocity fluid (gas or liquid) discharge
- Parts ejected at high speed
- Contact with fluids that may be hot, cold, toxic or otherwise injurious
- Explosion or burning of the fluid
- Lines/hoses whipping dangerously
- Damage or destruction to other components or equipment in the system



### **CAUTION** **Safety Precautions**

- Inspect the regulator before each use.
- Never connect regulators to a supply source having a pressure greater than the maximum rated pressure of the regulator, valve or accessory.
- Refer to product label (model specific) for maximum inlet pressures . If this rated pressure cannot be found, contact your local TESCOM representative for the designed pressure rating of all equipment (e .g., supply lines, fittings, connections, filters, valves, gauges, etc.) in your system . All must be capable of handling the supply and operating pressure.
- Install circuit protection on input voltage to electrical controls of the regulator per local and environment codes.
- Clearly establish flow direction of the fluid before installation of regulators, valves and accessories. It is the responsibility of the user to install the equipment in the correct direction
- Remove pressure from the system before tightening fittings, gauges or component.
- Never turn regulator or valve body. Instead hold regulator or valve body and turn fitting nut.
- Take precautions before touching the regulator while in operation.
- If a regulator or valve leaks or malfunctions, take it out of service immediately.
- Do not modify equipment or add attachments not approved by the manufacturer.
- Do not open enclosures when energized. Do not open enclosures when explosive atmosphere may be present.
- For pressure reducing regulators, it is highly recommended that the control knob or adjusting screw be turned fully counterclockwise before applying inlet pressure.
- Apply pressure to the system gradually, avoiding a sudden surge of fluid or pressure shock to the equipment in the system.
- Regulators are not shut-off devices. Install a pressure relief device downstream of the regulator to protect the process equipment from overpressure conditions. Shut off the supply pressure when the regulator is not in use.
- Periodic inspection and scheduled maintenance of your equipment is required for continued safe operation.
- The frequency of servicing is the responsibility of the user based on the application. Never allow problems or lack of maintenance to go unreported.
- Read and follow precautions on compressed gas cylinder labels.
- It is important that you analyze all aspects of your application and review all available information concerning the product or system. Obtain, read and understand the Material Safety Data Sheet (MSDS) for each fluid used in your system.
- Never use materials for regulators, valves or accessories that are not compatible with the fluids being used.
- Users must test components for material compatibility with the system operating conditions prior to use in the system.
- Vent fluids to a safe environment and in an area away from personnel. Be sure that venting and disposal methods are in accordance with Federal, State and Local requirements. Locate and construct vent lines to prevent condensation or gas accumulation. Make sure the vent outlet is not obstructed by rain, snow, ice, vegetation, insects, birds, etc.

- Do not interconnect vent lines; use separate lines if more than one vent is needed. Do not locate regulators, valves or accessories controlling flammable fluids near open flames or any other source of ignition.
- Some fluids when burning do not exhibit a visible flame. Use extreme caution when inspecting and/or servicing systems using flammable fluids to avoid death or serious injury to personnel. Provide a device to warn personnel of these dangerous conditions.
- Many gases can cause suffocation. Make certain the area is well ventilated. Provide a device to warn personnel of lack of Oxygen.
- Never use oil or grease on these regulators unless recommended as specified in Operations and Service procedures. Oil and grease are easily ignited and may combine violently with some fluids under pressure.
- Have emergency equipment in the area if toxic or flammable fluids are used.
- Upstream filters are recommended for use with all fluids.
- Do not bleed system by loosening fittings.
- Prevent icing of the equipment by removing excess moisture from the gas.
- Always use proper thread lubricants and sealants on tapered pipe threads.

## 3 Installation, Operations and Maintenance

Assembly & installation drawings, Bill of Materials, and parts lists for your product may be obtained by contacting Emerson. Emerson will provide these by email, fax or mail. Your local TESCOM™ sales representative can provide additional assistance. Be sure to have your complete model number ready. See back page for contact information.

### 3.1 General Information

TESCOM™ 44-6800E Series Electrically Heated Vaporizing diaphragm-sensed pressure reducing regulators are specifically engineered for applications requiring dependable pressure regulation. These regulators are especially appropriate for installations where high system pressures (up to 6000 psi) must be reduced to levels suitable for actuating low pressure (0 psig/0 bar to 500 psig/35 bar) instruments and related equipment.

In addition, the 44-6800E Series “Vaporizing” regulator is designed to offset the effects of the Joule-Thompson cooling effect that occurs when there is a pressure drop in a gas. It can also be used to vaporize a liquid into a gas in some applications.

The electrical board inside the housing powers an electrical heater that indirectly heats the process media. This heater is controlled by the electrical board for temperatures ranging from 122 °F/50 °C to 752 °F/400 °C. There is a thermocouple within the heater core to provide temperature feedback. There is a secondary thermal device, thermal cut off (TCO), within the regulator assembly.

**Figure 1:**

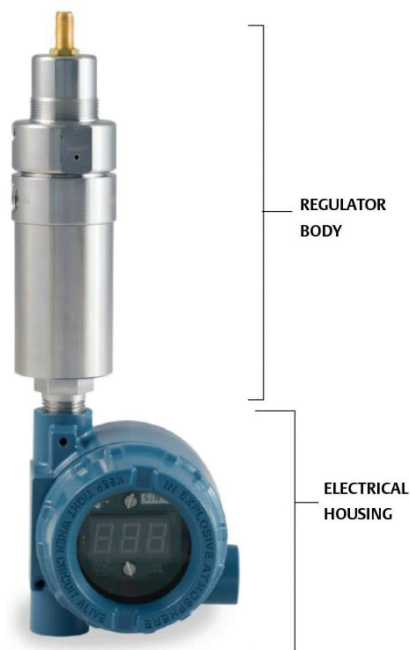

*ELECTRIC (Shown with optional LED display).*

### 3.1.1 Operating Parameters/Special Conditions For Safe Use

**Maximum Inlet Pressure:**

3,500 psig / 241 bar / 24,132 kPa Standard  
6,000 psig / 414 bar / 41368 kPa Optional

**Maximum Outlet Pressure:**

500 psig / 34.5 bar / 3,448 kPa

**Outlet Pressure Ranges:**

0-25, 0-50, 0-100, 0-250, 0-500 psig  
0-17, 0-34, 0-69, 0-172, 0-345 bar  
0-172, 0-345, 0-690, 0-1724, 0-3448 kPa

**Design Proof Pressure**

150% maximum rated

**Leakage:**

Internal: Bubble-tight  
External: Designed to meet  $\leq 2 \times 10^{-8}$  atm cc/sec He

**Voltage:**

100 - 240 VAC, 50/60 Hz, 400W at 240VAC, 100W at 120VAC

**Full Load Amps:**

2.0 Amps at 240VAC, 1.1 Amps at 120 VAC\*  
\*Controller has 3 Amp fuse rated for 350 VAC

**Flow Capacity:**

Cv = 0.02 - Standard

Refer to catalog and part number for options.

Supply Voltage (VAC)	Heater Watts (W)	Max. Ambient Temperature	
		Electrical Housing	Regulator Body
100 - 240	100 - 400	149 °F/65 °C	185 °F/85 °C

All cables, cable glands and conductors need >95 °C rating.

For integral applications the electronics enclosure must engage the regulator assembly by at least 5 full threads made wrench tight.



## 3.2 Installation

### 3.2.1 Installation Precautions

 **WARNING**

Make sure that the components and materials used in the fluid handling system are compatible with the fluid and have the proper pressure rating. Failure to do so can result in death, serious injury and/or property damage.

A regulator is not intended to be used as a shutoff device. When the regulator is not in use, the inlet supply should be turned off. As a safety precaution, a pressure relief device should be installed downstream of the regulator.

 **CAUTION**

Do not open packaging until ready for installation or in a clean environment. Product is cleaned in accordance with CGA 4.1 and ASTM G93, Verification Type 1, Test 1 and Test 2. With periodic verification of cleaning process to MIL-STD-1330D.

Inspect the regulator for physical damage and contamination. Do not connect the regulator if you detect oil, grease or damaged parts. If the regulator, valve or accessory is damaged, contact your local TESCOM representative to have the regulator cleaned or repaired.

 **CAUTION**

Follow all laws, regulations and industry requirements for electrical wiring. All electrical wiring must be terminated in an inaccessible location. Where the electrical housing is separate from the regulator body appropriate wiring to connect the two assemblies shall follow hazardous location requirements per applicable laws and regulations.

Possible consequences include but are not limited to:

- a. Make sure the regulator and electrical housing is mounted securely.
- b. Make sure the electrical power is turned off and locked out.
- c. Connect external ground if required to electrical housing.
- d. Remove electrical housing cover.
- e. Remove power supply connector and (if used) the 4-20 mA output connector from the electrical board. See Figure 2.
- f. Feed power supply wires and (if used) the 4-20 mA output wires through the 1/2" NPT port. See Figure 2.
- g. Screw the power supply and (if used) 4-20 mA output wires to the connectors and internal ground. See Figure 2.
- h. Verify all connections before applying power. Make sure the supply power is in working range of unit purchased.
- i. If the 4-20 mA output is used, an isolated excitation voltage of 20-28 volts is needed. The 4-20 mA output correlates to a thermocouple temperature reading of 50 to 400 °C / 122 to 752 °F. See Figure 2.

---

**Notice**

**Should the thermocouple fail the analog output would read greater than 25 mA and no electrical power will be supplied to the heating element. Disconnect power and check wiring.**

---

- j. Adjust the temperature with the TRIM1 potentiometer. TRIM1 potentiometer, located on the electrical board, provides a 270° of adjustment. The temperature set point range is from 50 °C /122 °F (fully counter clockwise position) to 400 °C /752 °F (fully clockwise position). See Figure 3.  
 Product does not provide actual media temperature. Actual media temperature should be taken from a different device.
- k. Heater Temperature Feedback Display (Optional):  
 The display reads the temperature of the heater in degrees Celsius.
- l. Temperature Set Button (Only with Optional Display):  
 This button is located on the control board. See Figure 4.  
 When pressed down the display will show the heater set point temperature.
- m. Place stopping plugs in any unclosed conduit entry.

**Figure 2:**

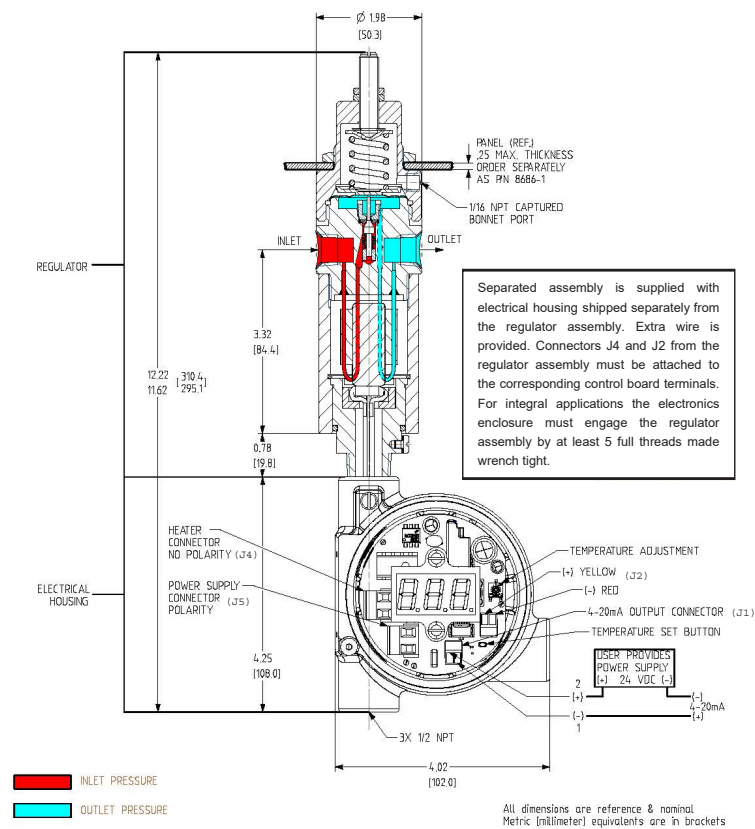

Figure 3:

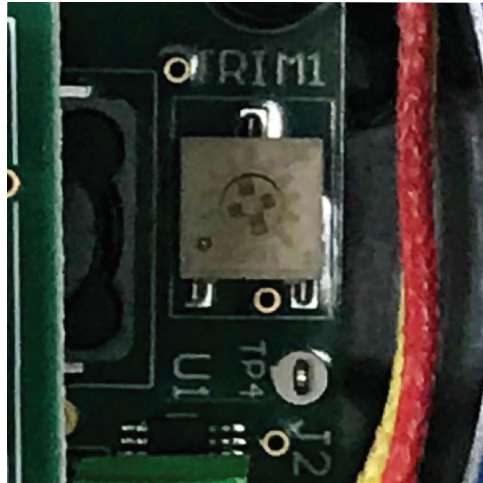
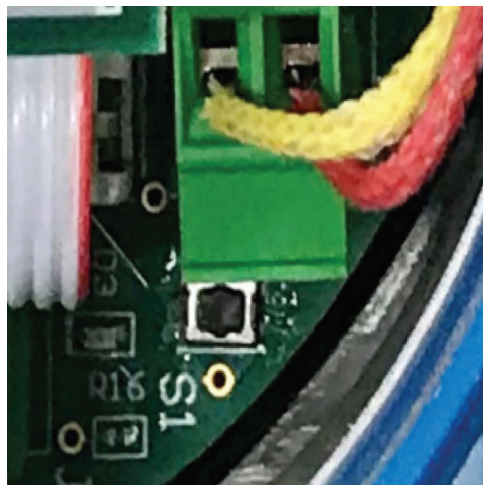

Figure 4:



## 3.3 Operation

### 3.3.1 Regulator Adjustment

Controlled outlet pressure settings are obtained using TESCO<sup>TM</sup> pressure reducing regulators by adjusting the screw. Rotating the adjustment screw clockwise raises the outlet pressure while a counterclockwise rotation coupled with venting of the downstream side of the regulator plumbing lowers the outlet pressure. Final adjustments should be made in the direction of increasing pressure to obtain the most accurate set point.

TESCO<sup>TM</sup> regulators will operate with any liquid or gaseous media compatible with the wetted materials.

### 3.3.2 Heater Temperature Controller Status

RED LED on the heater controller printed circuit board helps to show that there is NO power to the controller when the LED stays off. See Figure 5.

- When LED is flashing, there is power to the controller and the heater.
- When the LED stays on without flashing, there is an error:
  - \*Temperature feedback is out of range
  - \*Temperature set-point is out of range
  - \*Temperature feedback lag. The feedback has been unable to meet the set-point value.

Note: Temperature feedback lag is available on firmware revisions prior to V3-02.

Heater temperature feedback is provided with a 4-20mA signal. The 4-20 mA output correlates to a thermocouple temperature reading of 50 to 400 °C / 122 to 752 °F.

Figure 5:

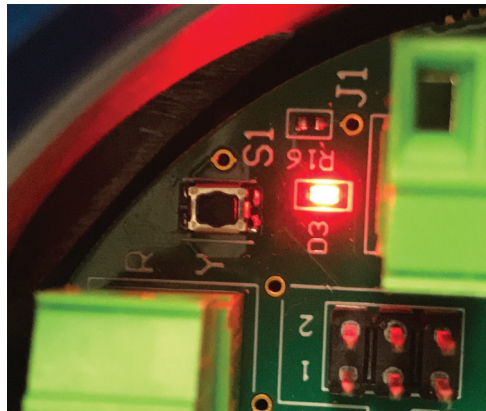

## 3.4 Maintenance and Repair Service

### 3.4.1 Repair Service

If a regulator or valve leaks or malfunctions, take it out of service immediately. You must have instructions before doing any maintenance. Do not make any repairs you do not understand. Have qualified personnel make repairs. Return any equipment in need of service to your equipment supplier for evaluation and prompt service. Equipment is restored to the original factory performance specifications, if repairable. There are flat fee repair charges for each standard model. The original equipment warranty applies after a complete overhaul.

Any disassembly and/or reassembly of this unit must be performed in accordance with IEC 60079-19, *Explosive Atmospheres - Part 19: Equipment Repair, Overhaul and Reclamation*.

 **WARNING**

Do not modify equipment or add attachments not approved by the manufacturer. Failure to do so can result in death, serious injury and/or property damage.

 **CAUTION**

**Proper Component Selection**

- a. Consider the total system design when selecting a component for use in a system.
- b. The user is responsible for assuring all safety and warning requirements of the application are met through his/her own analysis and testing.
- c. Emerson may suggest material for use with specific media upon request. Suggestions are based on technical compatibility resources through associations and manufacturers. Emerson does **NOT** guarantee materials to be compatible with specific media -- **This is responsibility of the user!**
- d. Component function, adequate ratings, proper installation, operation and maintenance are the responsibilities of the system user.

### 3.4.2 Mechanical Pressure Regulator Function

The following procedures are provided to enable the customer to perform all normal maintenance and repair operations. These operations are more easily performed with the regulator removed from the line.

An Assembly Drawing and Bill of Material for the regulator will be needed to complete maintenance procedures. The Assembly Drawing and Bill of Material are separate from this manual and available by contacting Emerson (see back page for contact information).

 **WARNING**

To avoid personal injury, property damage or equipment damage caused by sudden release of pressure or explosion of accumulated gas, do not attempt any maintenance or disassembly without first isolating the regulator from system pressure and relieving all internal pressure from the regulator.

To avoid personal injury, electrical power must be turned off and locked out prior to attempting any maintenance or disassembly.

### Mechanical Disassembly

Bold letters within the steps indicate component location in Figure 6.

The following steps outline the disassembly of pressure reducing regulators for maintenance and repair:

- a. Clamp the regulator in a vise by the side of the regulator body **K**.
- b. Turn adjusting screw **A** counterclockwise to insure removal of all spring force on the diaphragm.
- c. Remove upper portion of regulator bonnet **B**.  
NOTE: Upper portion of regulator includes spring button **C**, load spring **D**, back-up plate **E**, and diaphragm **F**. Review correct drawing to ensure that all parts have been disassembled.
- d. The valve parts can now be removed from the regulator body by turning the seat retainer **G** counterclockwise until it is free of the regulator body.

### Mechanical Reassembly

The regulator is reassembled in the reverse order of disassembly, observing the following precautions. Please reference the Bill of Material and Assembly Drawing for the correct location of replacement parts and correct torque specifications:

- a. Inspect all parts and replace those worn or damaged with TESCOM™ replacement parts.
- b. All parts should be cleaned to the cleanliness level required for safe operation with the media and system they will be used in. All parts in the flow stream must be free of particles which could prevent proper seating of the main valve **J**.
- c. Apply a thin uniform coating of fluorocarbon grease to the following parts: Indentation of spring button **C**, threaded portion of adjusting screw **A**, entire threaded areas of the spring bonnet **B** and heat exchanger housing **N**.

#### **WARNING**

Do not apply any type of grease to the internal parts of the regulator that contact the process media. Do NOT apply any type of grease to the inlet or outlet connections.

- d. Valve seat **H** must be installed with the chamfered side towards the main valve.
- e. The body **K** and bonnet are best joined by holding the bonnet assembly open end up and dropping all required items into place one at a time. The last item to be placed in the bonnet will be the diaphragm **F**.

It can be centered on the seating surface of the bonnet before the body assembly is inverted and screwed into the bonnet firmly – hand tight. Regulator should then be placed in a vise and the bonnet re-torqued to correct specifications.

See Assembly Drawing.

Figure 6: Basic Assembly Drawing

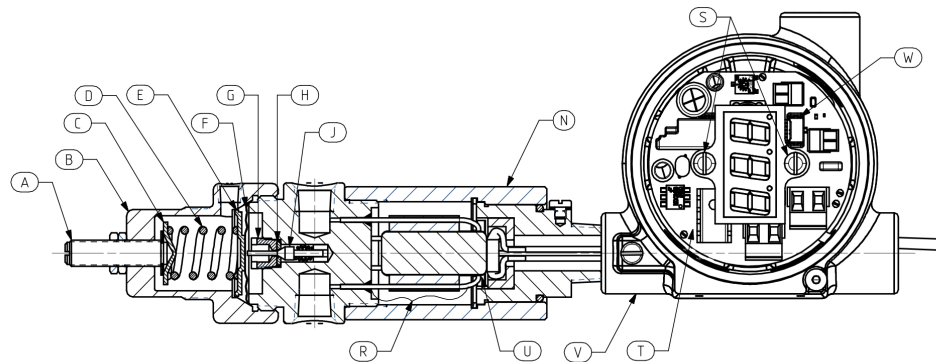

### 3.4.3 Electric Heater Function

The following procedures are provided to enable the customer to perform all normal maintenance and repair operations. These operations are more easily performed with the regulator removed from the line.

An Assembly Drawing and Bill of Materials for the regulator and heater will be needed to complete maintenance procedures. The assembly drawing and bill of materials are separate from this manual and available by contacting Emerson (see last page for contact information).

**! WARNING**

To avoid personal injury, property damage or equipment damage caused by sudden release of pressure or explosion of accumulated gas, do not attempt any maintenance or disassembly without first isolating the regulator from system pressure and relieving all internal pressure from the regulator.

To avoid personal injury, electrical power must be turned off and locked out prior to attempting any maintenance or disassembly.

**! WARNING**

- Heater bonnet (N) joints are not to be repaired or removed.
- For integral applications the electronics enclosure must engage the regulator assembly by at least 5 full threads made wrench tight.
- Seal required must be sealed within 450mm (18 inches) of enclosures.
- Wiring entering and existing this enclosure must be suitable for 95°C or higher.
- Install circuit protection on input voltage to electrical controls of the regulator and adhere to proper electrical grounding practices per local and environment codes.
- If heater is not properly performing return to the factory.

## 4 Certifications and Warranty

### 4.1 Hazardous Location Ratings

WARNING-DO NOT OPEN WHEN ENERGIZED  
OPEN CIRCUIT BEFORE REMOVING COVER  
OUVRIR LE CIRCUIT AVANT  
D'ENLEVER LE COUVERCLE

SEE INSTALLATION DOCUMENT

100-240 VAC 400 WATT 50/60 Hz

-40°C < Tamb < 85°C

DO NOT INSULATE

ONLY USE PROVIDED MOUNTING METHODS

70174303



CL I, DIV 1, GRP B,C,D, CL II, DIV I, GRP E, F, G; T3  
CL I, ZONE 1, AEx db IIB+H2 T3 Gb,  
ZONE 21, AEx tb IIIC T200°C Db  
SINGLE SEAL

SEAL REQUIRED WITHIN  
450MM (18 in) OF THE ENCLOSURE  
UN SCELLEMENT DOIT ETRE INSTALLE  
A MOINS DE 450 MM DU BOITER

CE 0344 Ex II 2 G

Ex db IIB+H2 T3 Gb; Ex tb IIIC T200°C Db  
SIRA 19ATEX1062X

Ex db IIB+H2 T3 Gb; Ex tb IIIC T200°C Db  
IECEX CSA 19.0008X  
PROCESS SEALED



## 4.2 Declaration of Conformity

EU DECLARATION OF CONFORMITY ATEX Directive 2014/34/EU	
Model Number:	44-6800
Product Name:	Vaporizing Regulator
Manufacturer's Name:	Tescom Corporation
Manufacturer's Address:	12616 Industrial Boulevard Elk River, Minnesota 55330-2491 United States of America
European Contact:	TESCOM EUROPE GMBH & CO. KG An der Trave 23-25 23923 Selmsdorf, Germany +49 38823 31 211
EC-Type Examination Certificate Number:	
Sira 19ATEX1062X	
Provisions of the Directive fulfilled by the Equipment:	
II 2GD Ex db IIB+H2 T3 Gb Ex tb IIIC T200°C Db	
Approved by the following notified body:	
Sira Certification Service Unit 6, Hawarden Industrial Park, Hawarden, CH5 3US, United Kingdom	
Harmonized Standards:	
EN IEC 60079-0:2018    EN 60079-1:2014    EN 60079-31:2014	
On behalf of the above named company, I declare that, to which this declaration relates, is in conformity with the provisions of the European Union Directives, including the latest amendments, as shown above. Assumption of conformity is based on the application of the harmonized standards and, when applicable or required, a European Union notified body certification.	
Approval: Brian Tutt	Title: Global Director of Engineering
	
Date: April 4, 2019	Location of Signature: Elk River, MN USA

## 4.3 Limited Warranty

TESCOM™ Corporation (“Seller”) warrants that the licensed firmware embodied in the goods will execute the programming instructions provided by Seller, and that the goods manufactured or services provided by Seller will be free from defects in materials or workmanship under normal use and care until the expiration of the applicable warranty period. Goods are warranted for twelve (12) months from the date of initial installation or eighteen (18) months from the date of shipment by Seller, whichever period expires first.

Consumables and services are warranted for a period of 90 days from the date of shipment or completion of the services. Products purchased by Seller from a third party for resale to Buyer (“Resale Products”) shall carry only the warranty extended by the original manufacturer. Buyer agrees that Seller has no liability for Resale Products beyond making a reasonable commercial effort to arrange for procurement and shipping of the Resale Products.

If buyer discovers any warranty defects and notifies Seller thereof in writing during the applicable warranty period, Seller shall, at its option, correct any errors that are found by Seller in the firmware of services or repair or replace F.O.B. point of manufacture that portion of the goods or firmware found by Seller to be defective, or refund the purchase price of the defective portion of the goods/services. All replacements or repairs necessitated by inadequate maintenance, normal wear and usage, unsuitable power sources or environmental conditions, accident, misuse, improper installation, modification, repair, storage or handling, or any other cause not the fault of Seller are not covered by this limited warranty, and shall be at buyer’s expense.

Seller shall not be obligated to pay any costs or charges incurred by buyer or any other party except as may be agreed upon in writing in advance by Seller. All costs of dismantling, reinstallation and freight and the time and expenses of Seller’s personnel and representatives for site travel and diagnosis under this warranty clause shall be borne by buyer unless accepted in writing by Seller.

Goods repaired and parts replaced by Seller during the warranty period shall be in warranty for the remainder of the original warranty period or ninety (90) days, whichever is longer.

This limited warranty is the only warranty made by Seller and can be amended only in a writing signed by Seller.

**THE WARRANTIES AND REMEDIES SET FORTH ABOVE ARE EXCLUSIVE. THERE ARE NO REPRESENTATIONS OR WARRANTIES OF ANY KIND, EXPRESSED OR IMPLIED, AS TO MERCHANTABILITY, FITNESS FOR PARTICULAR PURPOSE OR ANY OTHER MATTER WITH RESPECT TO ANY OF THE GOOD OR SERVICES.**



Visit us: [Emerson.com/TESCOM](https://www.emerson.com/tescom)  
Your local contact: [Emerson.com/contact](https://www.emerson.com/contact)



[Emerson.com](https://www.emerson.com)



[Facebook.com/EmersonAutomationSolutions](https://www.facebook.com/EmersonAutomationSolutions)



[LinkedIn.com/company/Emerson-Automation-Solutions](https://www.linkedin.com/company/Emerson-Automation-Solutions)



[Twitter.com/EMR\\_Automation](https://www.twitter.com/EMR_Automation)

The Emerson logo is a trademark and service mark of Emerson Electric Co. Brand logotype are registered trademarks of one of the Emerson family of companies. All other marks are the property of their respective owners. © 2020 Emerson Electric Co. All rights reserved.  
TR000058ENUS-02\_10-20

**TESCOM™**

