

Approvals Document - North America Zone Rosemount™ 8700M Magnetic Flowmeter Platform













Rosemount™ 8700M Magnetic Flowmeter Platform

Order Code	8732EM or 8712EM Transmitter Rating	8705M and 8711M/L Sensor (Flowtube) Rating	Region	Agency	Certification Number
-	Ordinary Location *	Ordinary Location *	USA, EU, Canada, EEU***	CSA or EAC	80102916 (CSA)
K5**, KU**	Explosion-Proof Class I Div 1; DIP	Explosion-Proof with Intrinsically Safe Electrodes Class I Div 1; DIP	USA	CSA	80102916
N5, N6	Non-Incendive Class I Div 2; DIP	Non-Incendive with Intrinsically Safe Electrodes Class I Div 2; DIP	USA & Canada	CSA	80102916
K6**	Flameproof, Increased Safety, and Dust. Zone 1	Increased Safety with Intrinsically Safe Electrodes and Dust. Zone 1	USA & Canada	CSA	80102916
ND	ATEX Dust with I.S. or Non-I.S. Outputs	ATEX Dust	EU	DEKRA	DEKRA 14ATEX0071 X
N1	ATEX Non-Sparking or Increased Safety; Dust	ATEX Non-Sparking or Increased Safety with Intrinsically Safe Electrodes ; Dust	EU	DEKRA	DEKRA 14ATEX0071 X
K1**	ATEX Flameproof with Increased Safety; Dust	ATEX Increased Safety with Intrinsically Safe Electrodes ; Dust	EU	DEKRA	DEKRA14ATEX0071 X
NF	IECEX Dust with I.S. or Non-I.S. Outputs	IECEX Dust	Global	DEKRA	IECEX DEK14.0031X
N7	IECEX Non-Sparking or Increased Safety; Dust	IECEX Non-Sparking or Increased Safety with Intrinsically Safe Electrodes; Dust	Global	DEKRA	IECEX DEK14.0031X
K7**	IECEX Flameproof with Increased Safety; Dust	IECEX Increased Safety with Intrinsically Safe Electrodes; Dust	Global	DEKRA	IECEX DEK14.0031X
N8	EAC Non-Sparking or Increased Safety; Dust	EAC Non-Sparking or Increased Safety with Intrinsically Safe Electrodes; EAC Dust	EEU ***	TOO T-Стандарт	EAЭC KZ 7500525.01.01.00972
K8**	EAC Flameproof with Increased Safety; Dust	EAC Increased Safety with Intrinsically Safe Electrodes; EAC Dust	EEU ***	TOO T-Стандарт	EAЭC KZ 7500525.01.01.00972
N2	INMETRO Non-Sparking or Increased Safety INMETRO Dust	INMETRO Non-Sparking or Increased Safety with Intrinsically Safe Electrodes and INMETRO Dust	Brazil	DNV INMETRO	DNV 18.0068 X DNV 23.0089 X DNV 23.0090 X
K2**	INMETRO Flameproof with Increased Safety INMETRO Dust	INMETRO Increased Safety with Intrinsically Safe Electrodes INMETRO Dust	Brazil	DNV INMETRO	DNV 18.0068 X DNV 23.0089 X DNV 23.0090 X
N9**	KTL Non-Sparking KTL Dust	KTL Non-Sparking with Intrinsically Safe Electrodes and KTL Dust	Korea	KTL	****
K9**	KTL Flameproof with Increased Safety ; Dust	KTL Increased Safety with Intrinsically Safe Electrodes and KTL Dust	Korea	KTL	Multiple KTL Certificate Numbers
N3	NEPSI Non-Sparking; Dust	NEPSI Non-Sparking with Intrinsically Safe Electrodes and NEPSI Dust	China	NEPSI	GYJ20.1130X
K3**	NEPSI Flameproof with Increased Safety; Dust	NEPSI Increased Safety with Intrinsically Safe Electrodes and NEPSI Dust	China	NEPSI	GYJ20.1130X
KW** NW	PESO Flameproof with Increased Safety PESO Non-Sparking or Increased Safety	PESO Increased Safety with Intrinsically Safe Electrodes PESO Non-Sparking or Increased Safety with Intrinsically Safe Electrodes	India	PESO	A/P/HQ/MH/104/7146 P532033/1, /2, /3. A/P/HQ/MH/104/6979 P528148/1

* Complies with only the local country product safety, electromagnetic, pressure and other applicable regulations. Cannot be used in a classified or zoned hazardous location environment. No ordering code required.

** Not applicable to 8712EM. | ***Eurasian Economic Union - EEU | **** Planned submittal or in process with agency.

Approval Markings and Logos

Symbol	Marking or Symbol Name	Region	Meaning of Marking or Symbol
	CE	European Union	Compliance with all applicable European Union Directives.
	ATEX	European Union	Compliance with Equipment and Protective systems intended for use in Potentially Explosive Atmospheres directive (ATEX) (2014/34/EU)
	C-tick	Australia	Compliance with Australian applicable electromagnetic compatibility standards
	CSA	US = United States C = Canada	Indicates that the product was tested and has met the applicable certification requirements for the noted countries.
	Eurasian Conformity (EAC)	Eurasian Economic Union - EEU	Compliance with all applicable EAC technical regulations.
	EAC Hazardous Location	Eurasian Economic Union - EEU	Compliance with Technical regulation, (TR CU 012/2011) – The safety of equipment for use in explosive environments.
	EEU Pattern Approval Certificate	Eurasian Economic Union - EEU	Indicates compliance of measuring instruments with the approved metrological and technical characteristics.
	DNV INMETRO	Brazil	Compliance with all applicable technical regulations of Brazil.
	NEPSI	China	Compliance with all applicable technical regulations of China.
	KTL	Korea	Compliance with all applicable technical regulations of Korea.
	NTEP	North America	National Conference on Weights and Measures – National Type Evaluation Program (NTEP).

Product designated for Ordinary Location may be marked with CE, C-tick, CSA and/or EAC logos.

European Directive Information

The most recent revision of the EU Declaration of Conformity can be found at www.emerson.com.

Certifications

Canadian Standards Association (CSA)

Ordinary Location Certification CLASS 2252 06 (Canada) and CLASS 2252 86 (US)

The transmitter and flowtube have been examined and tested to determine that the design meets basic electrical, mechanical, and fire protection requirements by CSA, a nationally recognized testing laboratory (NRTL) as accredited by the Federal Occupational Safety and Health Administration (OSHA).

CLASS 2258 02 - PROCESS CONTROL EQUIPMENT - For Hazardous Locations – To Canadian Requirements.

N6 & N5	Class I, Groups A, B, C and D (Intrinsically Safe Output and Electrode circuit)
N6 & N5	Class I, Division 2, Groups A, B, C and D (Non-Incendive)
N6 & N5	Class II, Division 1, Groups E, F and G; Class III (Dust Ignition Proof)
K6	Class I, Zone 1 – Flame Proof, Increased Safety with Intrinsic safety
K6	Class II, Zone 21, - Protection by Enclosure

Magnetic Flow Meter – Model 8732EM Transmitter with integral or remote mount or Model 8712EM Transmitter remote mount to Model 8705M or Model 8711M/L Magnetic Flow Tubes. Enclosure Type 4X and IP66 Rated; DUAL SEAL-8705M and 8711M/L.

Temperature Class, Maximum Surface Temperatures, and Ambient temperature ranges are defined for Integral and Remote mount configurations on Rosemount Drawings 08732-2061 (Division Installation) or 08732-2066 (Zone Installation). Equipment provides IS and NON-IS connections in accordance with drawing 08732-2061 or 08732-2066.

CLASS 2258 82 - PROCESS CONTROL EQUIPMENT - For Hazardous Locations –To US Requirements

KU, K5	Class I, Division 1, Groups C and D (Explosion Proof)
N6, N5, KU, K5	Class I, Groups A, B, C and D (Intrinsically Safe Output and Electrode circuit)
N6, N5, KU, K5	Class I, Division 2, Groups A, B, C and D (Non-Incendive)
N6, N5, KU, K5	Class II, Division 1, Groups E, F and G; Class III (Dust Ignition Proof)
K6	Class I, Zone 1 – Flame Proof, Increased Safety with Intrinsic safety
K6	Class II, Zone 21, - Protection by Enclosure

Magnetic Flow Meter – Model 8732EM Transmitter with integral or remote mount or Model 8712EM Transmitter remote mount to Model 8705M or Model 8711M/L Magnetic Flow Tubes. Enclosure Type 4X and IP66 Rated.

Temperature Class, Maximum Surface Temperatures, and Ambient temperature ranges are defined for Integral and Remote mount configurations on Rosemount Drawings 08732-2061 (Division Installation) or 08732-2066 (Zone Installation). Equipment provides IS and NON-IS connections in accordance with drawing 08732-2061 or 08732-2066.

Special Conditions of Safe Use for Class/Division: 8732EM

1. For use with the appropriate 8705M and 8711M/L Flow tubes only.
2. When the 8732EM transmitter is integrally mounted to 8705M or 8711M/L Flow Tubes, the ambient temperature ranges marked on each product need to be taken into consideration before installation. The Ambient temperature range for 8732EM transmitter is $-40^{\circ}\text{C} \leq T_a \leq +60^{\circ}\text{C}$ and the ambient temperature range for 8705M or 8711M/L Flow Tubes is $-29^{\circ}\text{C} \leq T_a \leq +60^{\circ}\text{C}$. Therefore, the -29°C rating of the flow tubes will limit the overall cold temperature range of the complete system unless other approved temperature control methods are employed.
3. When the 8732EM transmitter is integrally mounted to 8705W or 8711R/U flow tubes, the ambient temperature ranges marked on each product need to be taken into consideration before installation. The ambient temperature for 8732EM transmitter is -40°C to 60°C and the ambient temperature range for 8705W or 8711R/U flowtube is -50°C to 60°C . Therefore, the -40°C rating of the transmitter will limit the overall cold temperature range of the complete system unless other approved temperature control methods are employed.

4. The intrinsically safe 4-20 mA and pulse output cannot withstand the 500 V isolation test between signal and ground, due to integral transient protection up to a voltage of 250 Vac. This must be taken into account upon installation.

Special Conditions for Safe Use (X) for Class Zone: 8732EM

1. Warning – Ignition hazard, wetted parts may contain Titanium and Zirconium. For processes requiring EPL Ga and Gb rated equipment, suitability for use must be determined by the end user to eliminate ignition hazard due to impact or friction.
2. When “Special Paint Systems” are applied, instructions for safe use regarding potential electrostatic charging hazard have to be followed.
3. Terminals 1,2,3,4, for data communication, cannot withstand the 500 V isolation test between Signal and ground, due to integral transient protection. This must be taken into account upon Installation.
4. Conduit entries must be installed to maintain the enclosure ingress rating of IP66.
5. In order to maintain the ingress protection level on the M3 and M4 electrode housing, the copper crush washer that seals the electrode access plug shall be replaced when the plug is reinstalled. The copper crush washer is one time use only.
6. The flow tube and transmitter are not allowed to be thermally insulated.
7. The property class of the special fasteners which attach the Magnetic Flow Tube or Transmitter Remote Junction Box to the Magnetic Transmitter is A2-70 or A4-70 SST.
8. For information on the dimensions of the flameproof joints the manufacturer shall be contacted.
9. The Magnetic Flow Meter Tube contains nonconductive liners over the grounded tube. For process requiring EPL Ga, precautions shall be taken to avoid the liner being charged by the flow of nonconductive media.

Special Conditions of Safe Use for Class/Division: 8705M / 8711M/L

1. The flow tube is IP68 only when mounted remotely from the transmitter.
2. Options V1, V2, or V3 are not Type 4X Corrosion Resistant.
3. Options F0234, V1, V2, or V3 may be subject to electrostatic discharge. To avoid electrostatic charge build-up, do not rub the flowmeter with a dry cloth or clean with solvents.

Special Conditions for Safe Use (X) for Class Zone: 8705M / 8711M/L

1. Warning – Ignition hazard, wetted parts may contain Titanium and Zirconium. For processes requiring EPL Ga and Gb rated equipment, suitability for use must be determined by the end user to eliminate ignition hazard due to impact or friction.
2. When “Special Paint Systems” are applied, instructions for safe use regarding potential electrostatic charging hazard have to be followed.
3. Terminals 1,2,3,4, for data communication, cannot withstand the 500 V isolation test between Signal and ground, due to integral transient protection. This must be taken into account upon Installation.
4. Conduit entries must be installed to maintain the enclosure ingress rating of IP66.
5. In order to maintain the ingress protection level on the M3 and M4 electrode housing, the copper crush washer that seals the electrode access plug shall be replaced when the plug is reinstalled. The copper crush washer is one time use only.
6. The flow tube and transmitter are not allowed to be thermally insulated.
7. The property class of the special fasteners which attach the Magnetic Flow Tube or Transmitter Remote Junction Box to the Magnetic Transmitter is A2-70 or A4-70 SST.
8. For information on the dimensions of the flameproof joints the manufacturer shall be contacted.
9. The Magnetic Flow Meter Tube contains nonconductive liners over the grounded tube. For process requiring EPL Ga, precautions shall be taken to avoid the liner being charged by the flow of nonconductive media.

Special Conditions of Safe Use for Class/Division: 8712EM

1. For use with the appropriate 8705 and 8711 Flow tubes only.
2. The intrinsically safe 4-20 mA and pulse output cannot withstand the 500 V isolation test between signal and ground, due to integral transient protection up to a voltage of 250 Vac. This must be taken into account upon installation.

Special Conditions for Safe Use (X) for Class Zone: 8712EM

1. Warning – Ignition hazard, wetted parts may contain Titanium and Zirconium. For processes requiring EPL Ga and Gb rated equipment, suitability for use must be determined by the end user to eliminate ignition hazard due to impact or friction.
2. When “Special Paint Systems” are applied, instructions for safe use regarding potential electrostatic charging hazard have to be followed.
3. Conduit entries must be installed to maintain the enclosure ingress rating of IP66.
4. In order to maintain the ingress protection level on the M3 and M4 electrode housing, the copper crush washer that seals the electrode access plug shall be replaced when the plug is reinstalled. The copper crush washer is one time use only.
5. The flow tube and transmitter are not allowed to be thermally insulated.
6. The property class of the special fasteners which attach the Magnetic Flow Tube or Transmitter Remote Junction Box to the Magnetic Transmitter is A2-70 or A4-70 SST.
7. For information on the dimensions of the flameproof joints the manufacturer shall be contacted.
8. The Magnetic Flow Meter Tube contains nonconductive liners over the grounded tube. For process requiring EPL Ga, precautions shall be taken to avoid the liner being charged by the flow of nonconductive media.
9. When utilizing the keypad of Magnetic Flow Transmitter Model 8712EM, instruction for safe use regarding potential electrostatic charging hazard have to be followed.
10. Terminals for the output signals of the magnetic Flow Transmitters, cannot withstand the 500 V isolation test between signal and ground, due to integral transient protection. This must be taken into account upon Installation.

Rosemount 8700M Magnetic Flowmeter Platform – IECEx and ATEX Approvals

1. Equipment Markings – See section VI in the tables on the following pages
 - a. EU-Type Examination Certificate (ATEX): DEKRA 14ATEX0071_X
 - b. Certificate of Conformity (IECEx): IECEx DEK 14.0031X
2. Required Documentation:
 - a. 08732-2060 Installation Drawing Model 8732EM, 8712EM, 8705M, 8711-M/L ATEX/IECEx Hazardous (Ex) Locations
3. Referenced Documentation:
 - a. 00825-0X00-4444.pdf, Transmitter Quick Installation Guide (Where X = Communications Protocol Code)
 - b. 00825-0100-4727.pdf, Sensor Quick Installation Guide
4. The Required and Referenced Documents listed above address the following items:
 - a. Instructions for safety i.e.
 - i. Putting into service
 - ii. Use
 - iii. Assembling and dismantling
 - iv. Maintenance, overhaul and repair
 - v. Installation
 - vi. Adjustment
 - b. Where necessary, training instructions
 - c. Details which allow a decision to be made as to whether the equipment can be used safely in the intended area under the expected operating conditions
 - d. Electrical parameters, maximum surface temperatures and other limit values
 - i. Electrical –
 1. See document 08732-2060

Rosemount 8732EM and 8712EM Flow Transmitter	
<i>Power input</i>	90 - 250VAC, 0.45A, 40VA 12 - 30VDC, 0.25A, 3W 12 - 42VDC, 1.2A, 15W
<i>Pulsed circuit</i>	<i>Internally powered (Active): Outputs up to 12VDC, 12.1mA, 73mW</i> <i>Externally powered (Passive): Input up to 28VDC, 100mA, 1W</i>
<i>4-20mA output circuit</i>	<i>Internally Powered (Active): Outputs up to 25mA, 24VDC, 600mW</i> <i>Externally Powered (Passive): Input up to 25mA, 30VDC, 750mW</i>
<i>MODBUS</i>	<i>Internally Powered (Active): Outputs up to 100mA, 3.3VDC, 100mW</i>
<i>Fieldbus</i>	<i>Externally Powered (Passive): 9-32VDC,</i>
<i>Profibus</i>	<i>Externally Powered (Passive): 9-32VDC,</i>
<i>Um</i>	250V
<i>Coil excitation output</i>	500mA, 40V max, 9W max
Rosemount 8705-M and 8711-M/L Flowtube⁽¹⁾	
<i>Coil excitation input</i>	500mA, 40V max, 20W max
<i>Electrode circuit</i>	5V, 200uA, 1mW

(1) Provided by the transmitter

- e. Special Conditions for Safe Use (X): 8732EM
 - i. Models marked with ESD warning label, do not rub surface with a dry cloth or clean with solvents to avoid electrostatic charge build-up.
 - ii. Conduit entries must be installed to maintain the enclosure ingress rating of IP66.
 - iii. Terminals for the output signals of the Magnetic Flow Transmitters, cannot withstand the 500 V isolation test between signal and ground, due to integral transient protection up to a voltage of 250 Vac. This must be taken into account upon installation.
 - iv. The property class of the special fasteners which attach the Magnetic Flow Tube or Transmitter Remote Junction Box to the Magnetic Transmitter is A2-70 or A4-70 SST.
 - v. For information on the dimensions of the flameproof joints the manufacturer shall be contacted.

- f. Special Conditions for Safe Use (X): 8712EM
 - i. Models marked with ESD warning label, do not rub surface with a dry cloth or clean with solvents to avoid electrostatic charge build-up.
 - ii. Conduit entries must be installed to maintain the enclosure ingress rating of IP66 or IP69K.
 - iii. When utilizing the keypad of Magnetic Flow Transmitter Model 8712EM, instructions for safe use regarding potential electrostatic charging hazard have to be followed.
 - iv. Terminals for the output signals of the Magnetic Flow Transmitters, cannot withstand the 500 V isolation test between signal and ground, due to integral transient protection up to a voltage of 250 Vac. This must be taken into account upon installation.

- g. Special Conditions for Safe Use (X): 8705M and 8711M/L
 - i. The Magnetic Flow Tubes wetted parts may contain Titanium and Zirconium. It is the responsibility of the end user to eliminate ignition hazards due to impact or friction for processes that require EPL Ga or Gb.
 - ii. The Magnetic Flow Tube contains non conductive liners covering the grounded flow tube. For process requiring EPL Ga, precautions shall be taken to avoid the liner being charged by the flow of nonconductive media.
 - iii. In order to maintain the ingress protection level on the M3 and M4 electrode housing of the Magnetic Flow Tubes, the copper crush washer that seals the electrode access plug shall be replaced when the plug is reinstalled. The copper crush washer is one time use only.
 - iv. The property class of the special fasteners which attach the Magnetic Flow Tube or Transmitter Remote Junction Box to the Magnetic Transmitter is A2-70 or A4-70 SST.
 - v. Models marked with ESD warning label, do not rub surface with a dry cloth or clean with solvents to avoid electrostatic charge build-up.
 - vi. For information on the dimensions of the flameproof joints the manufacturer shall be contacted.
 - vii. Conduit entries must be installed to maintain the enclosure ingress rating of IP66.

Nomenclature Magnetic Flow Transmitter Model 8732EM and electrical data

8732EM R 1 B 2 K1 ... M4 RT50 ... SH ... V1 ... F090...
I II III IV V VI VII VIII IX X

Designation	Explanation	Value	Explanation
I	Model	8732EM	Magnetic Flow Transmitter – Field Mount
II	Transmitter Mount	R T	Remote Mount Integral Mount
III	Transmitter Power Supply	1 2 3	AC (90 - 250 Vac, 50 / 60 Hz), not for Ex nA DC (12 - 42 Vdc) DC (12 - 30 Vdc)
IV	Outputs	A B F M P	Non-I.S.: 4 - 20 mA with digital HART Protocol & Scalable Pulse Output I.S.: 4 - 20 mA Intrinsically Safe Output with digital HART Protocol & Intrinsically Safe Scalable Pulse Output I.S.: Foundation Fieldbus / FISCO Intrinsically Safe & Intrinsically Safe Scalable Pulse Output Non-I.S.: Modbus RS-485 I.S.: Profibus & Intrinsically Safe Scalable Pulse Output
V	Conduit entries	1 or 4 2 or 5	½-14 NPT female CM20, M20 female
VI	Safety Approval Option	K1 ATEX K7 IECEx K9 IECEx N1 ATEX N7 IECEx	<p>⊕ II 2 (1) G Ex db eb [ia Ga] IIC T6...T3 Gb ⊕ II 2 D Ex tb IIIC T80 °C...T200 °C Db</p> <p>⊕ II 2 (1) G Ex db eb [ia Ga] IIC T6...T3 Gb ⊕ II 2 (1) D Ex tb [ia Da] IIIC T80 °C...T200 °C Db **</p> <p>⊕ II 2 (1) G Ex db [ia Ga] IIC T6...T3 Gb * ⊕ II 2 D Ex tb IIIC T80 °C...T200 °C Db</p> <p>⊕ II 2 (1) G Ex db [ia Ga] IIC T6...T3 Gb * ⊕ II 2 (1) D Ex tb [ia Da] IIIC T80 °C...T200 °C Db **</p> <p>Ex db eb [ia Ga] IIC T6...T3 Gb Ex tb IIIC T80 °C...T200 °C Db</p> <p>Ex db eb [ia Ga] IIC T6...T3 Gb Ex tb [ia Da] IIIC T80 °C...T200 °C Db **</p> <p>Ex db [ia Ga] IIC T6...T3 Gb * Ex tb IIIC T80 °C...T200 °C Db</p> <p>Ex db [ia Ga] IIC T6...T3 Gb * Ex tb [ia Da] IIIC T80 °C...T200 °C Db **</p> <p>Ex db eb [ia Ga] IIC T6...T3 Gb Ex tb IIIC T80 °C...T200 °C Db</p> <p>Ex db eb [ia Ga] IIC T6...T3 Gb Ex tb [ia Da] IIIC T80 °C...T200 °C Db **</p> <p>⊕ II 3 (1) G Ex nA [ia Ga] IIC T4...T3 Gc *** ⊕ II 3 (1) G Ex ec [ia Ga] IIC T4...T3 Gc *** ⊕ II 2 D Ex tb IIIC T80 °C...T200 °C Db</p> <p>⊕ II 3 (1) G Ex nA [ia Ga] IIC T4...T3 Gc *** ⊕ II 3 (1) G Ex ec [ia Ga] IIC T4...T3 Gc *** ⊕ II 2 (1) D Ex tb [ia Da] IIIC T80 °C...T200 °C Db **</p> <p>Ex nA [ia Ga] IIC T4...T3 Gc *** Ex ec [ia Ga] IIC T4...T3 Gc *** Ex tb IIIC T80 °C...T200 °C Db</p> <p>Ex nA [ia Ga] IIC T4...T3 Gc *** Ex ec [ia Ga] IIC T4...T3 Gc *** Ex tb [ia Da] IIIC T80 °C...T200 °C Db **</p> <p>NOTE: * Integral Mount (see II) option only ** Intrinsically Safe Output (see IV) options B, F, or P *** DC Transmitter Power Supply only (12 - 42 Vdc)</p>

Nomenclature Magnetic Flow Transmitter Model 8732EM and electrical data - continued

8732EM R 1 B 2 K1 ... M4 RT50 ... SH ... V1 ... F090...
I II III IV V VI VII VIII IX X

Designation	Explanation	Value	Explanation
VI continued	Safety Approval Option	ND ATEX	Ⓔ II 2 D Ex tb IIIC T80 °C...T200 °C Db
			Ⓔ II 2 (1) D Ex tb [ia Da] IIIC T80 °C...T200 °C Db **
		NF IECEx	Ex tb IIIC T80 °C...T200 °C Db
			Ex tb [ia Da] IIIC T80 °C...T200 °C Db**
			NOTE: * Integral Mount (see II) option only ** Intrinsically Safe Output (see IV) options B, F, or P ***DC Transmitter Power Supply only (12 - 42 Vdc)
VII	Display Option	M4 M5	LOI Display
VIII	Remote Cable Option	RTxx ****	Standard Temperature Component
		RHxx ****	Extended Temperature Component
			NOTE: **** Length = xx × 10 ft, max. 500 ft
IX	Options	--	Aluminum, standard paint
		SH	Stainless Steel Electronics Housing
		Vx	Special Paint Systems *****
X	Specials	F090x	Special Paint Systems *****
			NOTE: ***** Subject to special conditions for safe use.

Nomenclature Magnetic Flow Transmitter Model 8712EM and electrical data

8712EM R 2 B 2 NZ ... M4 RT50 ... Vx ... F090...
I II III IV V VI VII VIII IX X

Designation	Explanation	Value	Explanation
I	Model	8712EM	Magnetic Flow Transmitter – Field Mount
II	Transmitter Mount	R	Remote Mount
III	Transmitter Power Supply	1 2 3	AC (90 - 250 Vac, 50 / 60 Hz) DC (12 - 42 Vdc) DC (12 - 30 Vdc)
IV	Outputs	A B F M P	Non-I.S.: 4 - 20 mA with digital HART Protocol & Scalable Pulse Output I.S.: 4 - 20 mA Intrinsically Safe Output with digital HART Protocol & Intrinsically Safe Scalable Pulse Output I.S.: Foundation Fieldbus / FISCO Intrinsically Safe & Intrinsically Safe Scalable Pulse Output Non-I.S.: Modbus RS-485 I.S.: Profibus & Intrinsically Safe Scalable Pulse Output
V	Conduit entries	1 2	½-14 NPT female CM20, M20 female
VI	Safety Approval Option	N1 ATEX	⊕ II 3 (1) G Ex nA ic [ia Ga] IIC T4 Gc **
			⊕ II 3 (1) G Ex ec ic [ia Ga] IIC T4 Gc **
			⊕ II 2 D Ex tb IIIC T80 °C Db
			⊕ II 3 (1) G Ex nA ic [ia Ga] IIC T4 Gc **
			⊕ II 3 (1) G Ex ec ic [ia Ga] IIC T4 Gc **
			⊕ II 2 (1) D Ex tb [ia Da] IIIC T80 °C Db*
		N7 IECEX	Ex nA ic [ia Ga] IIC T4 Gc ** Ex ec ic [ia Ga] IIC T4 Gc ** Ex tb IIIC T80 °C Db
			Ex nA ic [ia Ga] IIC T4 Gc ** Ex ec ic [ia Ga] IIC T4 Gc ** Ex tb [ia Da] IIIC T80 °C Db*
		N9 IECEX	Ex nA ic [ia Ga] IIC T4 Gc ** Ex ec ic [ia Ga] IIC T4 Gc ** Ex tb IIIC T80 °C Db
			Ex nA ic [ia Ga] IIC T4 Gc ** Ex ec ic [ia Ga] IIC T4 Gc ** Ex tb [ia Da] IIIC T80 °C Db*
ND ATEX	⊕ II 2 D Ex tb IIIC T80 °C Db		
	⊕ II 2 (1) D Ex tb [ia Da] IIIC T80 °C Db*		
NF IECEX	Ex tb IIIC T80 °C Db		
	Ex tb [ia Da] IIIC T80 °C Db*		
			NOTE: * Intrinsically Safe Output (see IV) options B, F, or P ** DC Transmitter Power Supply only (12 - 42 Vdc)
VII	Display Option	-- M4 M5	Without LOI and keypad LOI + keypad Display
VIII	Remote Cable Option	Rxx	Standard Temperature Component
			NOTE: *** Length = xx × 10 ft, max. 500 ft
IX	Options	-- Vx	Aluminum, standard paint Special Paint Systems ****
X	Specials	F090x	Special Paint Systems ****
			NOTE: **** Subject to special conditions for safe use.

Nomenclature Magnetic Flow Tube Model 8705-M and electrical data

8705 ... S A 005 ... M4 K1 ... G1 L1 B3 ... J1 SC ... V1 ... SH ... F090x
 I II III IV V VI VII VIII IX X XI XII XIII XIV

Designation	Explanation	Value	Explanation
I	Model	8705	Magnetic Flow Tube
II	Electrode Material	Custom	See special conditions for safe use
III	Electrode Types	Custom	Seal of electrodes comply with IEC 61010-1.
IV	Line Size	005 to 360	½" NPS (15 mm) to 36" NPS (900 mm)
V	Electrode Housing *	M0 M1 M2 M3 M4	Category 2 G or 3 G, EPL Gb or Gc Category 2 G or 3 G, EPL Gb or Gc Category 1/2 G or 1/3 G, EPL Ga/Gb or Ga/Gc Category 1/2 G or 1/3 G, EPL Ga/Gb or Ga/Gc Category 1/2 G or 1/3 G, EPL Ga/Gb or Ga/Gc
VI	Safety Approvals	K1 ATEX	Ex eb ia IIC T5...T3 Ga/Gb *
			Ex tb IIIC T80 °C...T200 °C Db
			Ex eb ib IIC T5...T3 Gb **
			Ex tb IIIC T80 °C...T200 °C Db
		K7 IECEX	Ex eb ia IIC T5...T3 Ga/Gb *
			Ex tb IIIC T80 °C...T200 °C Db
		K9 IECEX	Ex eb ib IIC T5...T3 Gb **
			Ex tb IIIC T80 °C...T200 °C Db
		N1 ATEX	Ex nA ia IIC T5...T3 Ga/Gc * line sizes 8" - 36"
			Ex ec ia IIC T5...T3 Ga/Gc * line sizes 8" - 36"
Ex tb IIIC T80 °C...T200 °C Db			
Ex nA ic IIC T5...T3 Gc * line sizes 0.5" - 6" / **			
N7 IECEX	Ex ec ic IIC T5...T3 Gc * line sizes 0.5" - 6" / **		
	Ex tb IIIC T80 °C...T200 °C Db		
	Ex nA ia IIC T5...T3 Ga/Gc * line sizes 8" - 36"		
	Ex ec ia IIC T5...T3 Ga/Gc * line sizes 8" - 36"		
ND ATEX	Ex tb IIIC T80 °C...T200 °C Db		
	Ex nA ic IIC T5...T3 Gc * line sizes 0.5" - 6" / **		
NF IECEX	Ex ec ic IIC T5...T3 Gc * line sizes 0.5" - 6" / **		
			NOTE: * Electrode Housing M2, M3 and M4 only ** Electrode Housing M0 and M1 only
VII	Grounding rings material	Custom	See special conditions for safe use
VIII	Lining protector material	Custom	See special conditions for safe use
IX	Mounting Configuration	B3	Integral Mount with Model 8732EM
X	Optional conduit entries	J1	CM20, M20 female
XI	Remote Junction Box (RJB) material	--	Aluminum, standard paint
		SJ	316 Stainless steel
XII	Special paint options	Vx	Special Paint Systems ***
XIII	Wrapper (housing) material	--	Carbon Steel (w. Aluminum RJB), standard paint
		SH	316 Stainless Steel (w. Stainless Steel RJB)
XIV	Specials	F090x	Special Paint Systems ***
			NOTE: *** Subject to special conditions for safe use.

Nomenclature Magnetic Flow Tube Model 8711-M/L and electrical data

8711 ... S A 15F L ... K1 ... G1 ... J1 SC ... V1 ... F090x
 I II III IV V VI VII VIII IX X XI

Designation	Explanation	Value	Explanation
I	Model	8711	Magnetic Flow Tube
II	Electrode Material	Custom	See special conditions for safe use
III	Electrode Types	Custom	Seal of electrodes comply with IEC 61010-1.
IV	Line Size	015 to 080	1½" NPS (40 mm) to 8" NPS (900 mm)
V	Mounting Configuration	L M	Remote Mount from Transmitter Integral Mount with Transmitter
VI	Safety Approvals	K1 ATEX	⊕ II 2 G Ex eb ib IIC T5...T3 Gb ⊕ II 2 D Ex tb IIIC T80 °C...T200 °C Db
		K7 IECEx	Ex eb ib IIC T5...T3 Gb Ex tb IIIC T80 °C...T200 °C Db
		K9 IECEx	Ex eb ib IIC T5...T3 Gb Ex tb IIIC T80 °C...T200 °C Db
		N1 ATEX	⊕ II 3 G Ex nA ic IIC T5...T3 Gc ⊕ II 3 G Ex ec ic IIC T5...T3 Gc ⊕ II 2 D Ex tb IIIC T80 °C...T200 °C Db
		N7 IECEx	Ex nA ic IIC T5...T3 Gc Ex ec ic IIC T5...T3 Gc Ex tb IIIC T80 °C...T200 °C Db
		ND ATEX	⊕ II 2 D Ex tb IIIC T80 °C...T200 °C Db
		NF IECEx	Ex tb IIIC T80 °C...T200 °C Db
VII	Grounding rings material	Custom	See special conditions for safe use
VIII	Optional conduit entries	J1	CM20, M20 female
IX	Remote Junction Box material	-- SJ	Aluminum, standard paint * 316 Stainless steel *
			NOTE: *Flow Tube with Carbon Steel wrapper (housing)
X	Special paint options	Vx	Special Paint Systems **
XI	Specials	F090x	Special Paint Systems **
			NOTE: ** Subject to special conditions for safe use.



Declaration of Conformity

No: RFD1094 Rev. 0



We,

Emerson – Rosemount, Micro Motion Inc

12001 Technology Drive
Eden Prairie, MN 55344
USA

declare under our sole responsibility that the product:

Rosemount™ 8700M Magnetic Flowmeter Platform
Transmitters: 8732EM and 8712EM
Sensors (Flow Tubes): 8705M, 8711M/L and 8721

Authorized Representative in Europe:
Emerson S.R.L., company No. J12/88/2006,
Emerson 4 street, Parcul Industrial
Tetarom II, Cluj-Napoca 400638, Romania

Regulatory Compliance Shared Services Department
Email: europesproductcompliance@emerson.com
Phone: +40 374 132 035

to which this declaration relates, is in conformity with the provisions of the European Union Directives, including the latest amendments.

(signature and date of issue)

15 September 2023

Mark Fleigle

(name)

Vice President, Engineering

(function)

Eden Prairie, MN USA

(place of issue)

PED Notified Body

DNV Business Assurance Italia S.r.l.

[Notified Body Number: 0496]
Via Energy Park, 14, N-20871
Vimercate (MB), Italy

ATEX Notified Body for EU Type Examination Certificate

DEKRA Certification B.V. [Notified Body Number: 0344]
Meander 1051, 6825 MJ Arnhem
P.O. Box 5185, 6802 ED Arnhem
Country: The Netherlands

ATEX Notified Body for Quality Assurance

DNV Nemko Presafe AS [Notified Body Number: 2460]
P.O. Box 73, Blindern
0314 Oslo
Country: Norway

Declaration of Conformity

EMC Directive 2014/30/EU

All Models: Harmonized Standards: EN 51326-1: 2013

Low Voltage Directive 2014/35/EU

All Models: Harmonized Standards: EN 61010-1: 2010

RoHS Directive 2011/65/EU: Amended 2015/863

All models: Harmonized Standards: EN IEC 63000: 2018

PED Directive 2014/68/EU

Equipment without the 'PD' option is NOT PED compliant and cannot be used in the EU without further assessment unless the installation is exempt under Article 1, paragraph 2 of the PED Directive 2014/68/EU.

Model 8705M Magnetic Flowmeter Sensor with option 'PD', in line sizes 1.5-inch (DN40) to 36-inch (DN900).

DNV QS Certificate of Assessment

Certificate No. 10000497900-PA-ACCREDIA-USA

Module H Conformity Assessment - ASME B31.3: 2020

Model 8705M Magnetic Flowmeter Sensor with option 'PD', in line sizes 0.5-inch (DN15) to 1.0-inch (DN25).

Sound Engineering Practice - ASME B31.3: 2020

Model 8711M/L Magnetic Flowmeter Sensor with option 'PD', in line sizes 1.5-inch (DN40) to 8-inch (DN200).

DNV QS Certificate of Assessment

Certificate No. 10000497900-PA-ACCREDIA-USA

Module H Conformity Assessment - ASME B31.3: 2020

Model 8721 Magnetic Flowmeter Sensor, all sizes:

Sound Engineering Practice - ASME B31.3: 2020

ATEX Directive (2014/34/EU)**Magnetic Flow Transmitters 8732EM, 8712EM and Sensors 8705M, 8711M/L****DEKRA 14ATEX0071 X - CERTIFICATE****Equipment Marking Summary:**

II 2 (1) G Ex db eb [ia Ga] IIC T6...T3 Gb

II 2 (1) G Ex db [ia Ga] IIC T6...T3 Gb

II 3 (1) G Ex nA [ia Ga] IIC T4...T3 Gc

II 3 (1) G Ex ec [ia Ga] IIC T4...T3 Gc

II 3 G Ex nA ic IIC T5...T3 Gc

II 3 G Ex ec ic IIC T5...T3 Gc

II 3 (1) G Ex nA ic [ia Ga] IIC T4 Gc

II 3 (1) G Ex ec ic [ia Ga] IIC T4 Gc

II 1/2 G Ex eb ia IIC T5...T3 Ga/Gb

II 2 G Ex eb ib IIC T5...T3 Gb

II 1/3 G Ex nA ia IIC T5...T3 Ga/Gc

II 1/3 G Ex ec ia IIC T5...T3 Ga/Gc

II 2 D Ex tb IIIC T 80 °C...T 200 °C Db

II 2 (1) D Ex tb [ia Da] IIIC T 80 °C...T 200 °C Db

II 2 D Ex tb IIIC T 80 °C Db

II 2 (1) D Ex tb [ia Da] IIIC T 80 °C Db

Harmonized Standards:

EN IEC 60079-0: 2018 EN 60079-1: 2014 EN 60079-7: 2015 + A1: 2018 EN 60079-11: 2012

EN 60079-15: 2010 EN 60079-26: 2015 EN 60079-31: 2014

TABLE OF CONTENTS

PAGE	TITLE
2	GAS ENVIRONMENT - EPL Ga/Gb SENSOR WITH ALLOWED INTEGRAL MOUNT EPL Gb TRANSMITTERS
3	GAS ENVIRONMENT - EPL Ga/Gb SENSOR WITH ALLOWED REMOTE MOUNT EPL Gb OR EPL Gc TRANSMITTER
4	GAS ENVIRONMENT - EPL Ga/Gb SENSOR TEMPERATURE CODE VS. PROCESS TEMPERATURE
5	GAS ENVIRONMENT - EPL Ga/Gc SENSOR WITH ALLOWED INTEGRAL MOUNT EPL Gc TRANSMITTERS
6	GAS ENVIRONMENT - EPL Ga/Gc SENSOR WITH ALLOWED REMOTE MOUNT EPL Gb OR EPL Gc TRANSMITTERS
7	GAS ENVIRONMENT - EPL Ga/Gc SENSOR TEMPERATURE CODE VS. PROCESS TEMPERATURE
8	DUST ENVIRONMENT - EPL Db SENSOR WITH ALLOWED INTEGRAL MOUNT EPL Db TRANSMITTERS
9	DUST ENVIRONMENT - EPL Db SENSOR WITH ALLOWED REMOTE MOUNT EPL Db TRANSMITTERS
10	DUST ENVIRONMENT - EPL Db SENSOR TEMPERATURE CODE VS. PROCESS TEMPERATURE
11	GAS ENVIRONMENT - COIL AND ELECTRODE CIRCUIT WIRING
12	DUST ENVIRONMENT - COIL AND ELECTRODE CIRCUIT WIRING
13	GAS AND DUST ENVIRONMENT - OUTPUT WIRING
14	GAS AND DUST ENVIRONMENT - INTRINSICALLY SAFE ENTITY CONCEPTS
15	GAS AND DUST ENVIRONMENT - FISCO CONCEPT

⚠️ WARNING: EXPLOSION HAZARD - PRODUCT INSTALLATION SHALL COMPLY WITH INFORMATION AS STATED IN THIS DOCUMENT.

1. WIRING METHOD SUITABLE FOR APPROPRIATE ZONE AND PROTECTION TYPE.
2. TRANSMITTER MUST NOT BE CONNECTED TO EQUIPMENT GENERATING MORE THAN 250V.
3. COMPONENTS REQUIRED TO HAVE HAZARDOUS (Ex) LOCATION APPROVAL MUST BE APPROVED FOR THE GAS GROUP APPROPRIATE TO AREA CLASSIFICATION.
4. SEAL APPROVED FOR USE IN APPROPRIATE ZONE AND GAS GROUP.

5. THE ELECTRODE CIRCUIT AND WIRING MUST BE INSTALLED AS INTRINSICALLY SAFE WHEN THE FLOWTUBE IS INSTALLED IN A HAZARDOUS (Ex) AREA WITH MINIMUM EXPLOSION PROTECTION LEVEL (EPL) OF Gb (Ex Ib) WHEN USED WITH THE K6 OPTION, AND AN EPL OF Gc WITH THE NC OPTION. FLAMMABLE PROCESS FLUIDS WHICH REQUIRE AN EPL OF Ga (Ex Ia) FOR THE ELECTRODE CIRCUIT. SEE GAS ENVIRONMENT PAGES.
6. THE INTRINSICALLY SAFE 4-20mA AND DIGITAL OUTPUTS MUST USE TWISTED PAIR WITH AN INDIVIDUAL SHIELD FOR THE PAIR. IT IS ALSO RECOMMENDED TO USE SHIELDED TWISTED PAIR FOR THE PULSE OUTPUT.

7. USA-INSTALLATION SHALL BE IN ACCORDANCE WITH THE NATIONAL ELECTRICAL CODE (NEC), NFPA-70, AND ANSI/ISA-RP1206-01. CANADA-INSTALLATION SHALL BE IN ACCORDANCE WITH THE CANADIAN ELECTRICAL CODE (CEC) PART 1 (C22.1).
8. CONTROL EQUIPMENT CONNECTED TO BARRIER MUST NOT USE OR GENERATE MORE THAN 250V.
9. ASSOCIATED APPARATUS MANUFACTURER'S INSTALLATION DRAWING MUST BE FOLLOWED WHEN INSTALLING THIS EQUIPMENT.

10. THE TRANSMITTER IS NOT CAPABLE OF PASSING THE 500V ISOLATION TEST ON TERMINALS 1-10 DUE TO INTEGRAL TRANSIENT PROTECTION. THIS MUST BE TAKEN INTO ACCOUNT UPON INSTALLATION.
11. THE ROSEMOUNT CABLING KITS, FOR INTRINSICALLY SAFE ELECTRODES, INCLUDE A CERTIFICATE OF CONFORMITY (COC) FROM THE MANUFACTURER FOR CAPACITANCE PER FOOT & INDUCTANCE PER FOOT. THESE PARAMETERS ARE ONLY REQUIRED FOR THE ENTITY CONCEPT METHOD OF INSTALLATION.

12. FOR ALL INSTALLATIONS MAXIMUM TERMINAL TIGHTENING TORQUE IS 10.6 IN LBS.

13. - WARNING - EXPLOSION HAZARD - DO NOT DISCONNECT WHILE CIRCUIT IS LIVE UNLESS AREA IS KNOWN TO BE NON-HAZARDOUS.
 - AVERTISSEMENT - RISQUE D'EXPLOSION. NE PAS DEBRANCHER TANT QUE LE CIRCUIT EST SOUS TENSION, A MOINS QU'IL NE S'AGISSE D'UN EMPACEMENT NON DANGEREUX.
 - WARNING - AFTER DE-ENERGIZING, DELAY 10 MINUTES BEFORE OPENING.
 - AVERTISSEMENT - APRÈS MISE HORS TENSION, ATTENDRE 10 MINUTES AVANT L'OUVERTURE.
 - WARNING - POTENTIAL ELECTROSTATIC CHARGING HAZARD - SEE INSTRUCTIONS.
 - AVERTISSEMENT - DANGER POTENTIEL DE CHARGES ÉLECTROSTATIQUES - VOIR INSTRUCTIONS+

14. TRANSMITTER OUTPUTS ARE CONSIDERED INTRINSICALLY SAFE WHEN INSTALLED IN ACCORDANCE TO INTRINSICALLY SAFE CONCEPTS AND INSTALLATION REQUIREMENTS WITHIN THIS DOCUMENT.

NOTES:

EMERSON.	ROSEMOUNT	DRAWING NO. 08732-2066	REV AD
TITLE			
INSTALLATION DRAWING			
CSA CANADIAN AND USA ZONE			
DR. N. BOND	2/18/14	DRAWING NO. 08732-2066	
APPD. E. MESSENGER	6/13/14		
DO NOT SCALE PRINT	CAD MAINTAINED	PRODUCT CODE	SHEET 1 OF 15

GAS ENVIRONMENT- EPL Ga/Gb SENSOR WITH ALLOWED INTEGRAL MOUNT EPL Gb TRANSMITTERS

Ex eb SENSOR INTEGRAL MOUNT CONFIGURATIONS

MODEL 8705-M INTEGRAL MOUNT CONFIGURATION WITH SAFETY APPROVAL OPTION 'K6'



Ex eb Ia IIC T5...T3 Ga/Gb (WITH HOUSING CODE M2, M3, M4)
 Ex eb Ib IIC T5...T3 Gb (WITH HOUSING CODE M0, M1)
 EPL Gb, FOR USE IN HAZARDOUS (Ex) AREA - ZONE 1 OR 2 WITH CARBON STEEL HOUSING: (-29°C ≤ Ta ≤ 60°C)
 WITH STAINLESS STEEL HOUSING: (-50°C ≤ Ta ≤ 60°C)
 SEE TABLE 1 FOR PROCESS TEMPERATURE LIMITS AND ALLOWED MOUNTING CONFIGURATIONS
 DUAL SEAL PER ANSI/ISA 12.27.01 WITH HOUSING CODE M2, M3, M4
 INCREASED SAFETY WITH INTRINSICALLY SAFE ELECTRODES

MODEL 8711-M INTEGRAL MOUNT CONFIGURATION WITH SAFETY APPROVAL OPTION 'K6'

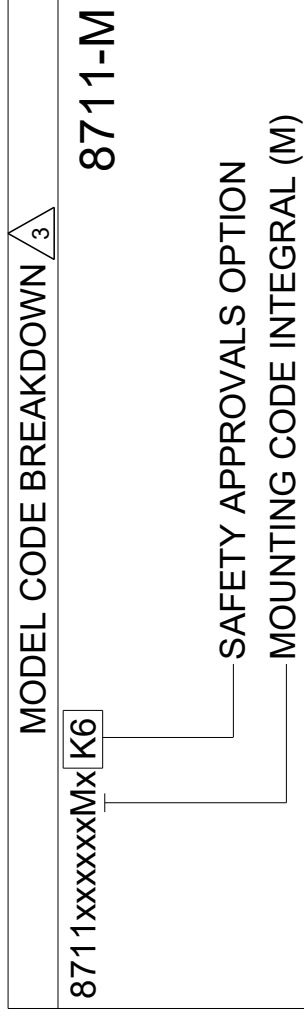

Ex eb IIC T5...T3 Gb.
 EPL Gb, FOR USE IN HAZARDOUS (Ex) AREA - ZONE 1 OR 2 WITH CARBON STEEL HOUSING: (-29°C ≤ Ta ≤ 60°C)
 WITH STAINLESS STEEL HOUSING: (-50°C ≤ Ta ≤ 60°C)
 SEE TABLE 2 FOR PROCESS TEMPERATURE LIMITS AND ALLOWED MOUNTING CONFIGURATIONS
 INCREASED SAFETY WITH INTRINSICALLY SAFE ELECTRODES

ALLOWED INTEGRAL MOUNT TRANSMITTER CONFIGURATIONS

MODEL 8732EM INTEGRAL MOUNT CONFIGURATION WITH SAFETY APPROVAL OPTION 'K6'

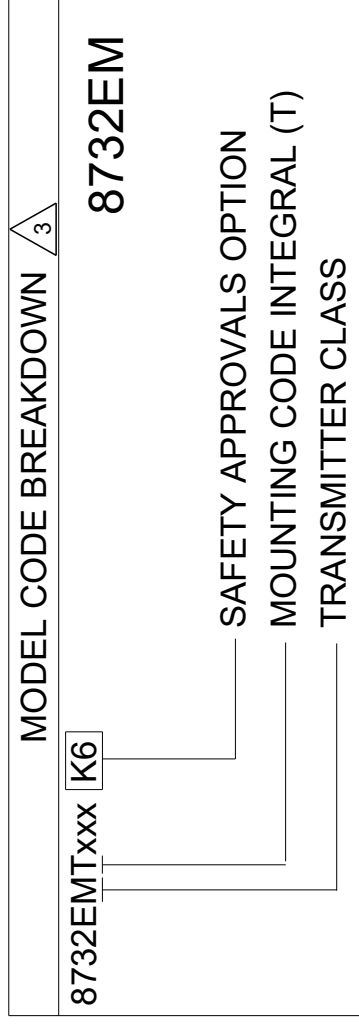

Ex db eb [Ia Ga] IIC T6...T3 Gb
 EPL Gb, FOR USE IN ZONE 1 OR 2
 SEE TABLE 1 OR TABLE 2 FOR TEMPERATURE CLASS
 FLAMEPROOF ELECTRONICS HOUSING, INCREASED SAFETY
 TERMINAL BLOCK WITH INTRINSICALLY SAFE ELECTRODE
 OUTPUT

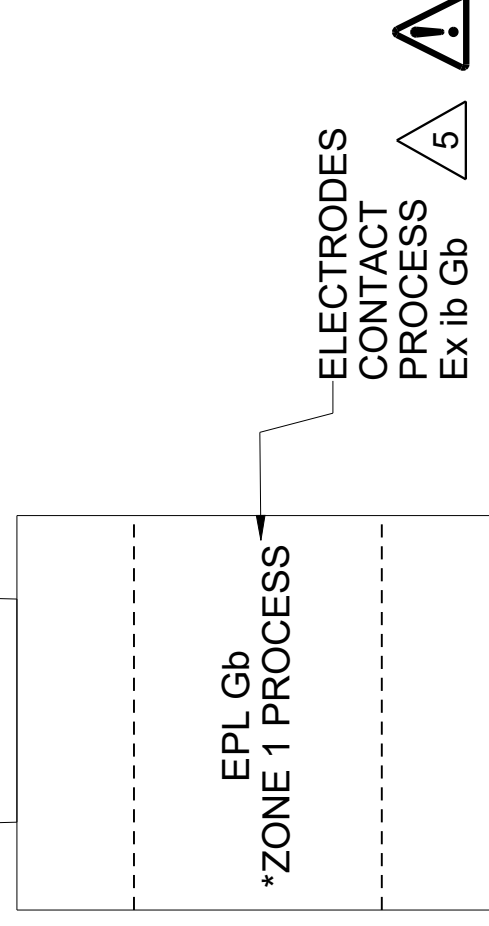
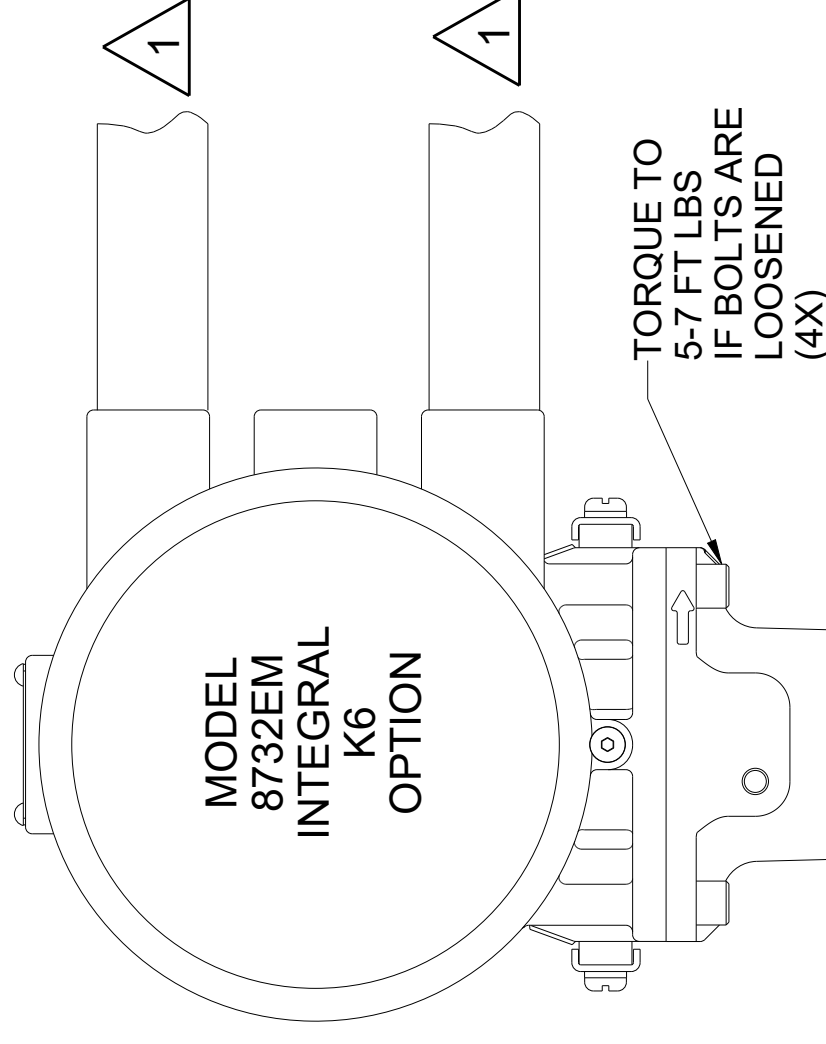
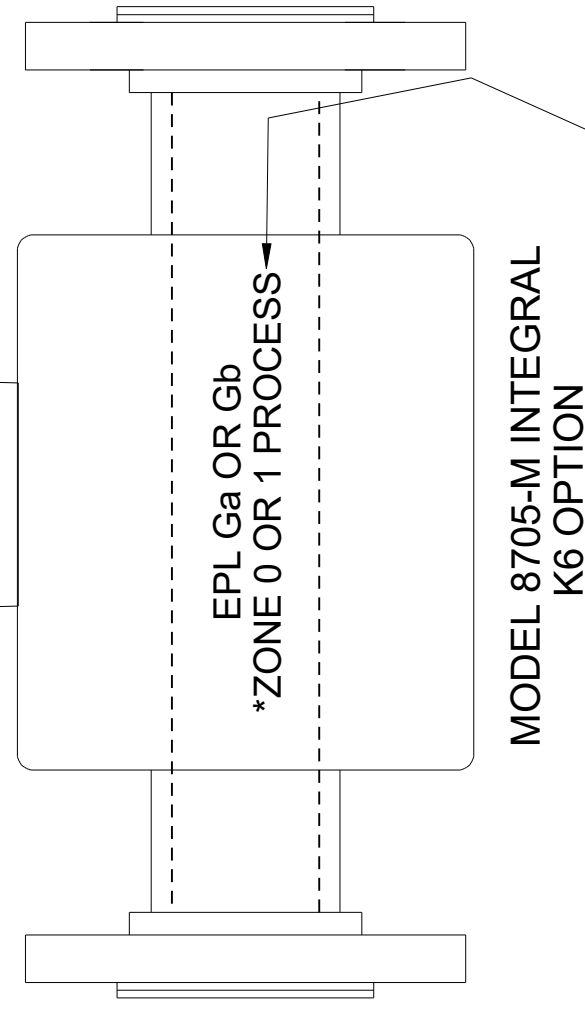
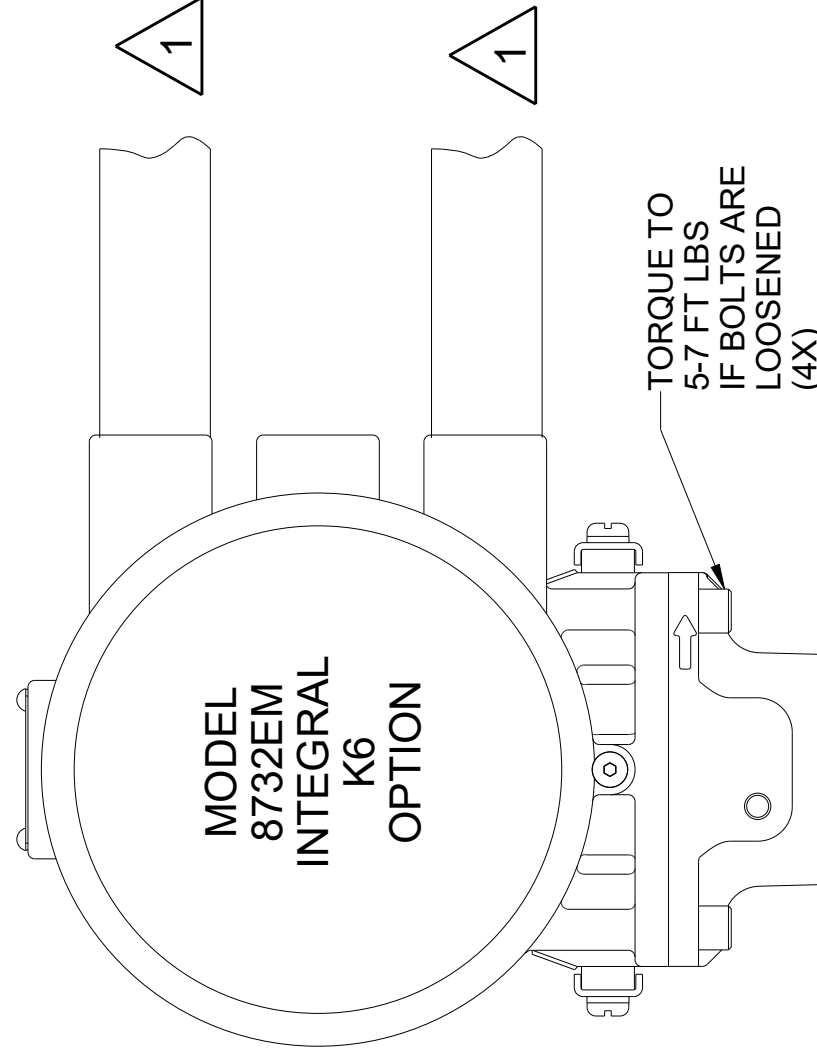

! 5
 ELECTRODES CONTACT PROCESS
 Ex Ia Ga WITH HOUSING M2, M3, M4
 Ex Ib Gb WITH HOUSING M0, M1

* TYPICAL APPLICATION. CONSULT LOCAL HAZARDOUS AREA (Ex) ZONING FOR PROCESS FLUID CLASSIFICATION.

CONFIDENTIAL AND PROPRIETARY INFORMATION IS CONTAINED HEREIN AND MUST BE HANDLED ACCORDINGLY.

UNLESS OTHERWISE SPECIFIED DIMENSIONS IN INCHES (mm). REMOVE ALL BURRS AND SHARP EDGES.

-DEC TOLERANCES-	
X ± .1	[2.5]
.XX ± .02	[0.5]
.XXX ± .010	[0.25]
FRACTIONS ± 1/32	ANGLES ± 2°

SURFACE FINISH UNLESS OTHERWISE SPECIFIED

125° 3RD ANGLE

SIZE C

SCALE -

REV AD

EMERSON
 TITLE ROSEMOUNT

INSTALLATION DRAWING
 CSA CANADIAN AND USA ZONE

DR. N. BOND 2/18/14 DRAWING NO. 08732-2066
 APPD. E. MESSENGER 6/13/14

DO NOT SCALE PRINT | CAD MAINTAINED. (PROE) | PRODUCT CODE | SHEET2 OF 15

DRAWING NO. 08732-2066

GAS ENVIRONMENT - EPL Ga/Gb SENSOR WITH ALLOWED REMOTE MOUNT EPL Gb OR EPL Gc TRANSMITTERS

Ex eb SENSOR REMOTE MOUNT CONFIGURATIONS

MODEL 8705-M REMOTE CONFIGURATION WITH SAFETY APPROVALS OPTION 'K6'

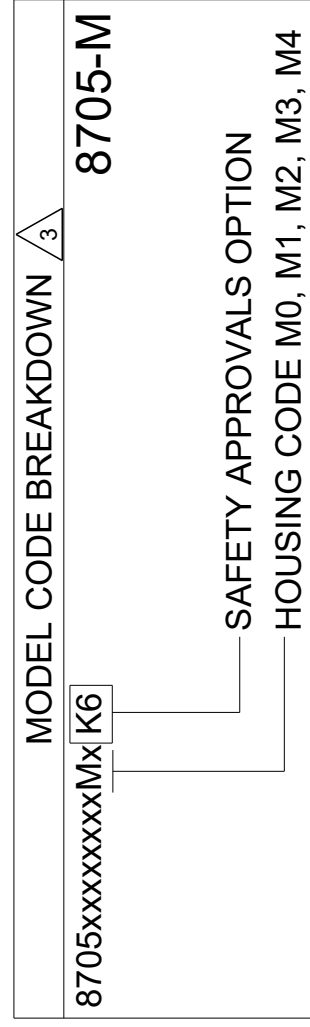

Ex eb ia IIC T5...T3 Ga/Gb (WITH HOUSING CODE M2, M3, M4)
Ex eb ib IIC T5...T3 Gb (WITH HOUSING CODE M0, M1)
EPL Gb, FOR USE IN HAZARDOUS (Ex) AREA - ZONE 1 OR 2 WITH CARBON STEEL HOUSING: (-29°C ≤ Ta ≤ 60°C)
WITH STAINLESS STEEL HOUSING: (-50°C ≤ Ta ≤ 60°C)
SEE TABLE 1 FOR PROCESS TEMPERATURE LIMITS AND ALLOWED MOUNTING CONFIGURATIONS
DUAL SEAL PER ANSI/ISA 12.27.01 WITH HOUSING CODE M2, M3, M4
INCREASED SAFETY WITH INTRINSICALLY SAFE ELECTRODES

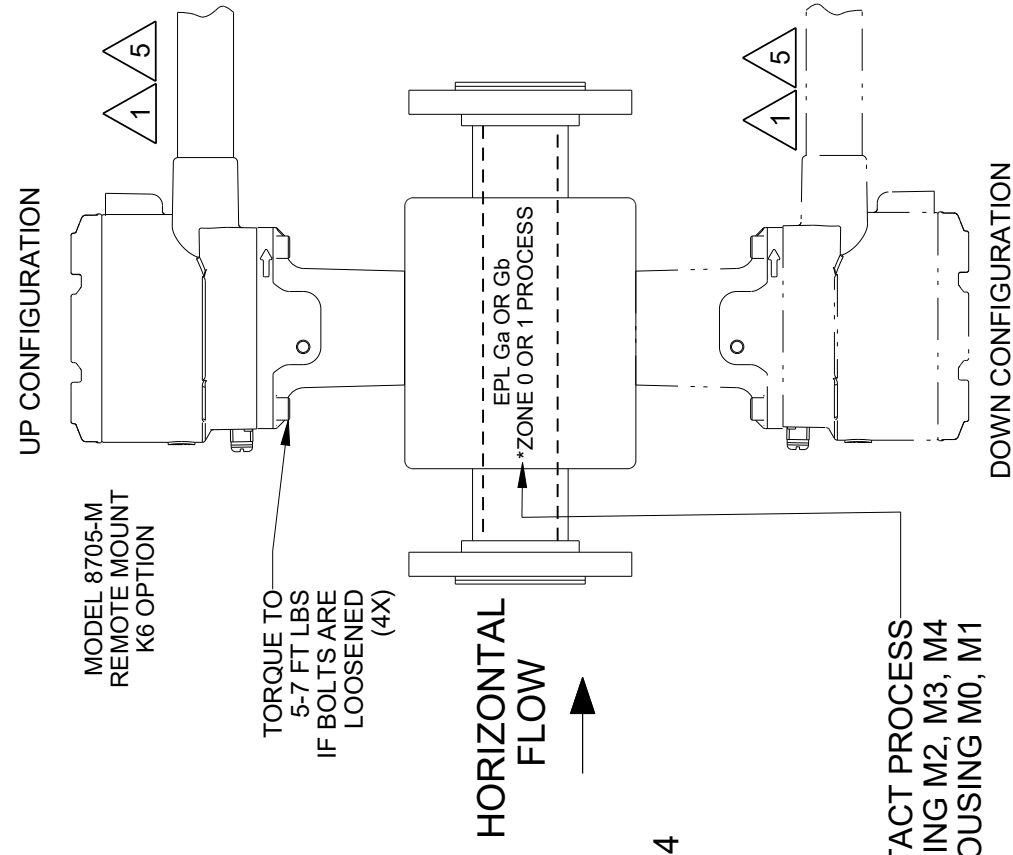

MODEL 8711-L REMOTE CONFIGURATION WITH SAFETY APPROVALS OPTION 'K6'



Ex eb IIC T5...T3 Gb.
EPL Gb, FOR USE IN HAZARDOUS (Ex) AREA - ZONE 1 OR 2 WITH CARBON STEEL HOUSING: (-29°C ≤ Ta ≤ 60°C)
WITH STAINLESS STEEL HOUSING: (-50°C ≤ Ta ≤ 60°C)
SEE TABLE 2 FOR PROCESS TEMPERATURE LIMITS AND ALLOWED MOUNTING CONFIGURATIONS
INCREASED SAFETY WITH INTRINSICALLY SAFE ELECTRODES

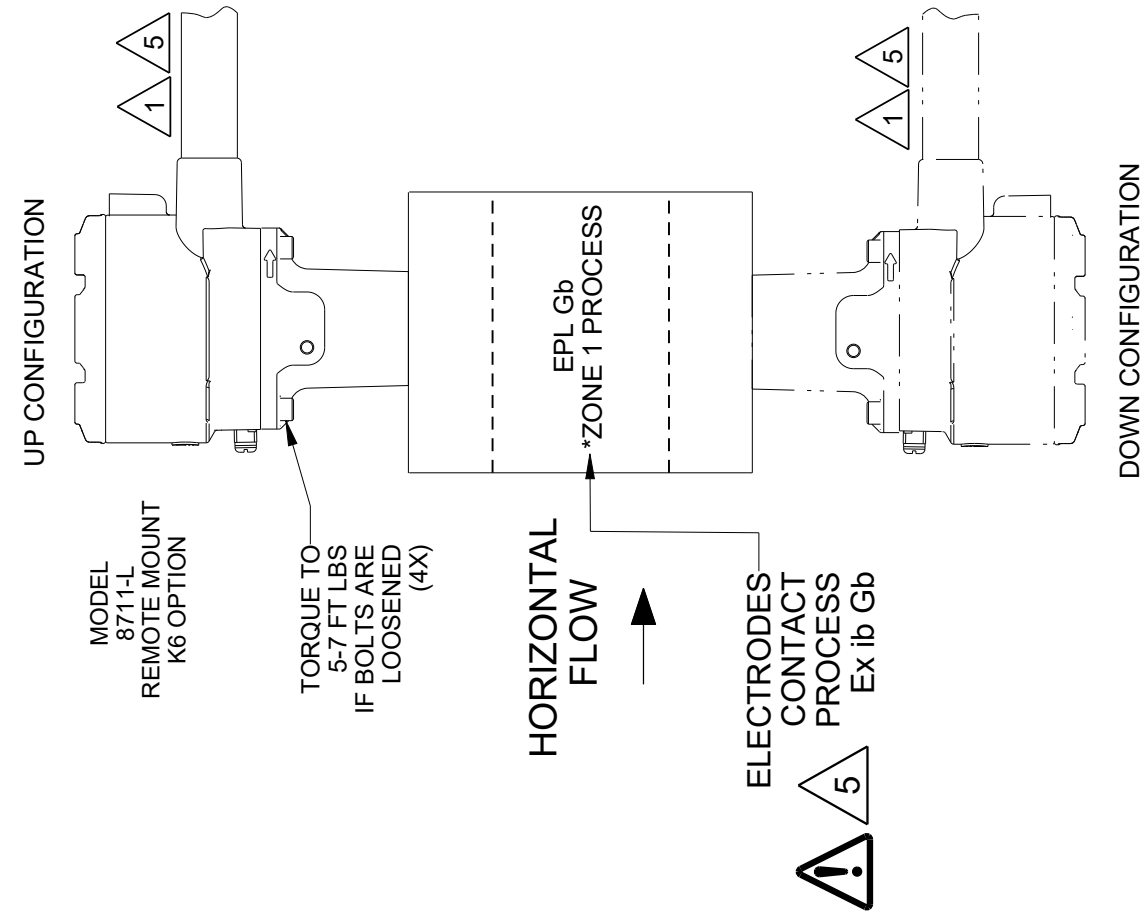

ALLOWED REMOTE MOUNT TRANSMITTER CONFIGURATIONS

MODEL 8732EM REMOTE MOUNT CONFIGURATION WITH SAFETY APPROVALS OPTION 'K6'

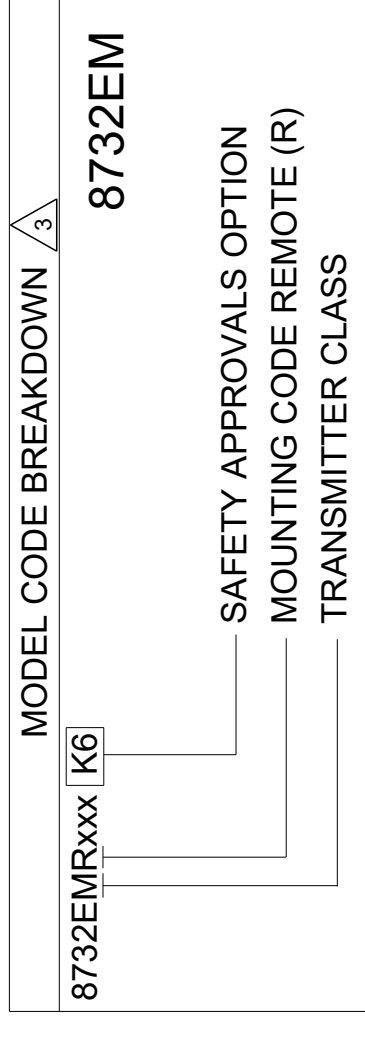

Ex db eb [ia Ga] IIC T6...T3 Gb
EPL Gb, FOR USE IN ZONE 1 OR 2
TEMPERATURE CLASS EPL Gb: T6 (-50°C ≤ Ta ≤ 60°C)
FLAMEPROOF ELECTRONICS HOUSING, INCREASED SAFETY
TERMINAL BLOCK WITH INTRINSICALLY SAFE ELECTRODE
OUTPUT, INCREASED SAFETY REMOTE JUNCTION BOX

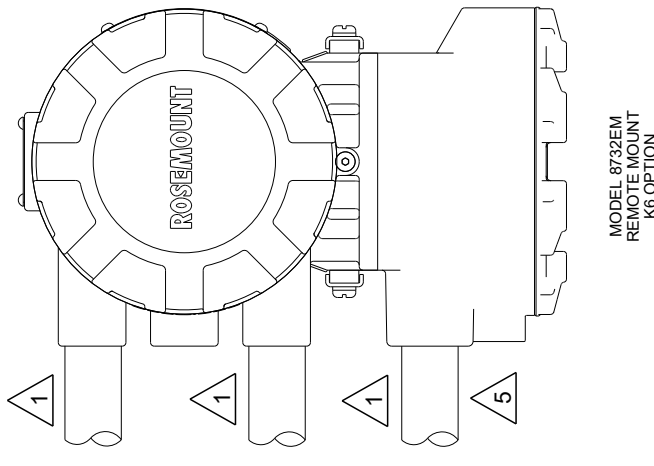

MODEL 8732EM REMOTE MOUNT CONFIGURATION WITH SAFETY APPROVALS OPTION 'NC'

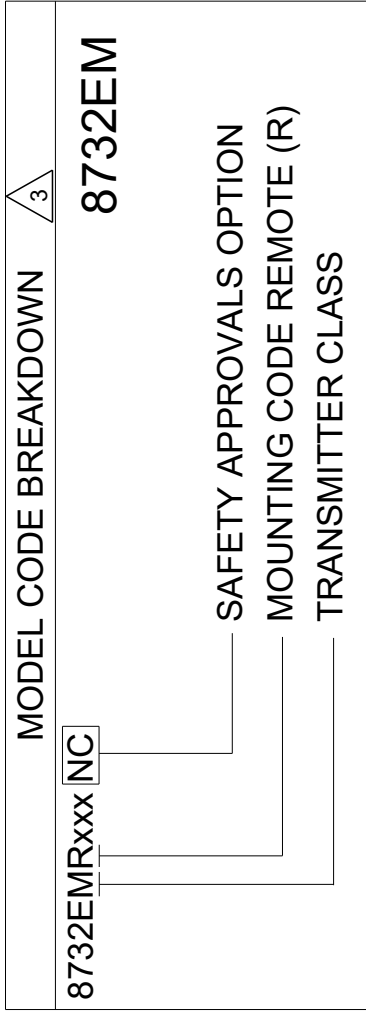

Ex nA [ia Ga] IIC T4...T3 Gc - DC POWER ONLY, IN PROTECTION TYPE 'n'
Ex ec [ia Ga] IIC T4...T3 Gc - DC POWER ONLY, IN PROTECTION TYPE 'e'
EPL Gc, FOR USE IN ZONE 2
TEMPERATURE CLASS: EPL Gc: T4 (-50°C ≤ Ta ≤ 60°C)
WITH INTRINSICALLY SAFE ELECTRODE OUTPUT.

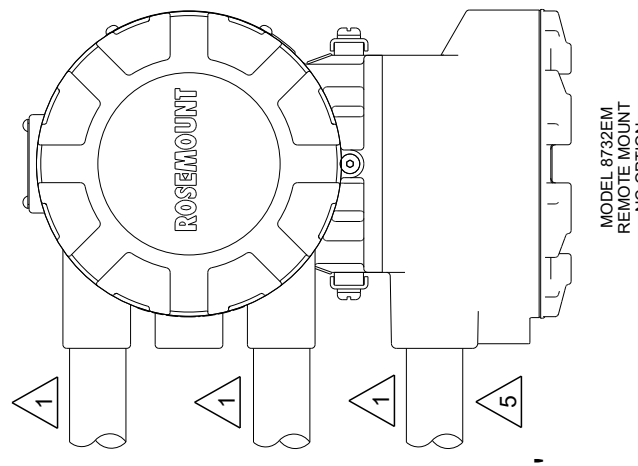

MODEL 8712EM REMOTE MOUNT CONFIGURATION WITH SAFETY APPROVALS OPTION 'NC'

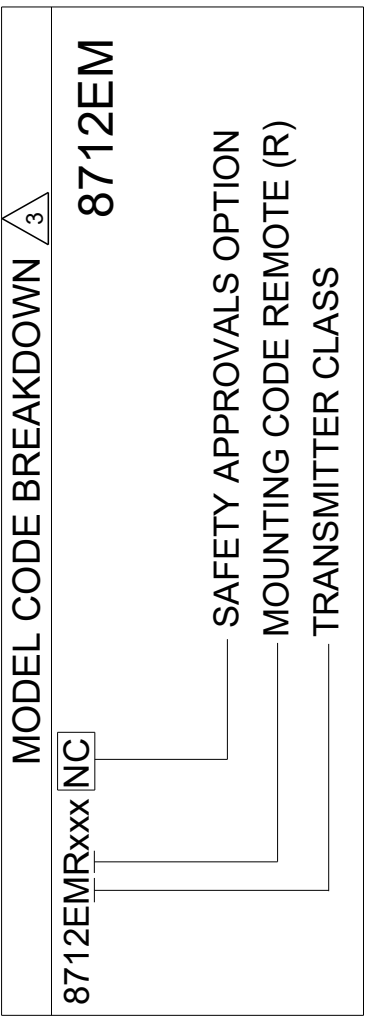

Ex nA ic [ia Ga] IIC T4 Gc - DC POWER ONLY, IN PROTECTION TYPE 'n'
Ex ec ic [ia Ga] IIC T4 Gc - DC POWER, IN PROTECTION TYPE 'e'
EPL Gc, FOR USE IN ZONE 2
TEMPERATURE CLASS: EPL Gc: T4 (-40°C ≤ Ta ≤ 60°C)
WITH INTRINSICALLY SAFE ELECTRODE OUTPUT

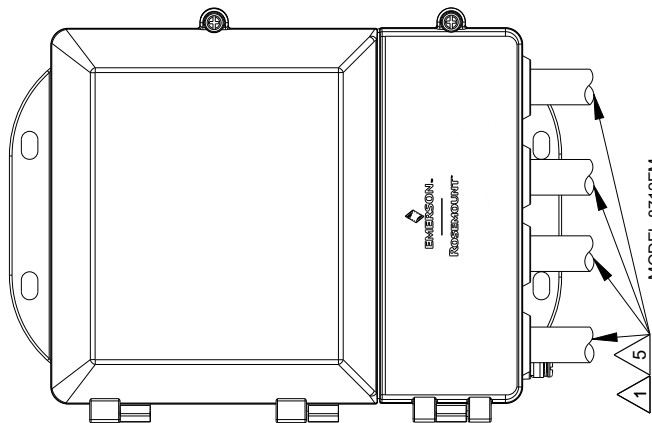

CONFIDENTIAL AND PROPRIETARY INFORMATION IS CONTAINED HEREIN AND MUST BE HANDLED ACCORDINGLY.	SURFACE FINISH UNLESS OTHERWISE SPECIFIED	125	3RD ANGLE	SIZE	C	SCALE	-	REV	AD
UNLESS OTHERWISE SPECIFIED DIMENSIONS IN INCHES (mm). REMOVE ALL BURRS AND SHARP EDGES.									
X ± .1 (2.5)									
.XX ± .02 (0.5)									
.XXX ± .010 (0.25)									
FRACTIONS ± .132	ANGLES ± .2°								
EMERSON ROSEMOUNT									
TITLE INSTALLATION DRAWING									
CSA CANADIAN AND USA ZONE									
DR.	N. BOND	2/18/14	DRAWING NO.						
APPD.	E. MESSENGER	6/13/14	08732-2066						
DO NOT SCALE PRINT CAD MAINTAINED, (PROJ) PRODUCT CODE SHEET 3 OF 15									

* TYPICAL APPLICATION. CONSULT LOCAL HAZARDOUS AREA (Ex) ZONING FOR PROCESS FLUID CLASSIFICATION.

GAS ENVIRONMENT - EPL Ga/Gb SENSOR TEMPERATURE CODE VS. PROCESS TEMPERATURE

**TABLE 1 - 8705-M: Ex eb - PROTECTION TYPE 'INCREASED SAFETY'
SAFETY APPROVAL OPTION 'K6'**

ALLOWED TRANSMITTER MOUNTING AND TEMPERATURE CODE VS. PROCESS TEMPERATURE

Line Size	Maximum Process Temperature (°C)	Temperature Code	Transmitter Mounting
0.5"	60	T5	Integral/Remote
	120	T4	Integral/Remote
	150	T3	Remote
1"	60	T5	Integral/Remote
	120	T4	Integral/Remote
	150	T3	Remote
1.5"	60	T5	Integral/Remote
	105	T4	Integral/Remote
	140	T3	Remote
2"	60	T5	Integral/Remote
	105	T4	Integral/Remote
	140	T3	Remote
2.5"	60	T4	Integral/Remote
	110	T4	Remote
	150	T3	Remote
3"	60	T5	Integral/Remote
	115	T4	Remote
	150	T3	Remote
4"	60	T5	Integral/Remote
	115	T4	Remote
	155	T3	Remote
5"	60	T5	Integral/Remote
	120	T4	Remote
	155	T3	Remote
6"	60	T5	Integral/Remote
	120	T4	Remote
	155	T3	Remote
8-36"	60	T5	Integral/Remote
	120	T4	Remote
	155	T3	Remote**

**LINE SIZES 8" AND GREATER SHOULD BE MOUNTED WITH REMOTE JUNCTION BOX (RJB) DOWN OR TO THE SIDE

**TABLE 2 - 8711-M/L: Ex eb - PROTECTION TYPE 'INCREASED SAFETY'
SAFETY APPROVAL OPTION 'K6'**

ALLOWED TRANSMITTER MOUNTING AND TEMPERATURE CODE VS. PROCESS TEMPERATURE

Line Size	Maximum Process Temperature (°C)	Temperature Code	Junction Box Orientation	Transmitter Mounting
1.5"	60	T5	Any	Integral/Remote
	100	T4	Any	Remote
	140	T3	Down	Remote
2"	60	T5	Any	Integral/Remote
	100	T4	Any	Remote
	140	T3	Down	Remote
3"	60	T4	Any	Integral/Remote
	110	T4	Any	Remote
	150	T3	Down	Remote
4"	60	T5	Any	Integral/Remote
	115	T4	Any	Remote
	155	T3	Down	Remote
6"	60	T5	Any	Integral/Remote
	115	T4	Any	Remote
	155	T3	Down	Remote
8"	60	T5	Any	Integral/Remote
	115	T4	Any	Remote
	160	T3	Down	Remote

08732-2066

DRAWING NO.

CONFIDENTIAL AND PROPRIETARY INFORMATION IS CONTAINED HEREIN AND MUST BE HANDLED ACCORDINGLY.	SURFACE FINISH UNLESS OTHERWISE SPECIFIED $\sqrt{125}$	3RD ANGLE	SIZE C	SCALE -	REV AD
ROSEMOUNT					
TITLE INSTALLATION DRAWING CSA CANADIAN AND USA ZONE					
-DEC TOLERANCES- X ± .1 [2.5] .XX ± .02 [0.5] .XXX ± .010 [0.25] FRACTIONS ± 1/32 ANGLES ± 2'					
UNLESS OTHERWISE SPECIFIED DIMENSIONS IN INCHES (mm). REMOVE ALL BURRS AND SHARP EDGES.					
DO NOT SCALE PRINT CAD MAINTAINED (PROJ) PRODUCT CODE SHEET 4 OF 15					

GAS ENVIRONMENT - EPL Ga/Gc SENSOR WITH ALLOWED REMOTE MOUNT EPL Gb OR EPL Gc TRANSMITTERS

Ex ec/Ex nA SENSOR REMOTE MOUNT CONFIGURATIONS

MODEL 8705-M REMOTE CONFIGURATION
WITH SAFETY APPROVAL OPTION 'NC'

MODEL CODE BREAKDOWN  3
8705xxxxxxxMx[NC] 8705-M

SAFETY APPROVALS OPTION
HOUSING CODE M0, M1, M2, M3, M4

Ex nA ia IIC T5 ... T3 Ga/Gc (WITH HOUSING CODE M2, M3, M4)
Ex ec ia IIC T5... T3 Ga/Gc (WITH HOUSING CODE M2, M3, M4)
Ex nA ic IIC T5 ... T3 Gc (WITH HOUSING CODE M0, M1)
Ex ec ic IIC T5... T3 Gc (WITH HOUSING CODE M0, M1)
EPL Gc, FOR USE IN HAZARDOUS (Ex) AREA - ZONE 2
WITH CARBON STEEL HOUSING: (-29°C ≤ Ta ≤ 60°C)
WITH STAINLESS STEEL HOUSING: (-50°C ≤ Ta ≤ 60°C)
SEE TABLE 3 FOR PROCESS TEMPERATURE LIMITS AND ALLOWED
MOUNTING CONFIGURATIONS

DUAL SEAL PER ANSI/ISA 12.27.01 WITH HOUSING CODE M2, M3, M4
TYPE 'e' OR TYPE 'n' PROTECTION WITH INTRINSICALLY
SAFE ELECTRODES

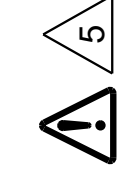

ELECTRODES CONTACT PROCESS
Ex ia Ga WITH HOUSING M2, M3, M4
Ex ic Gc WITH HOUSING M0, M1

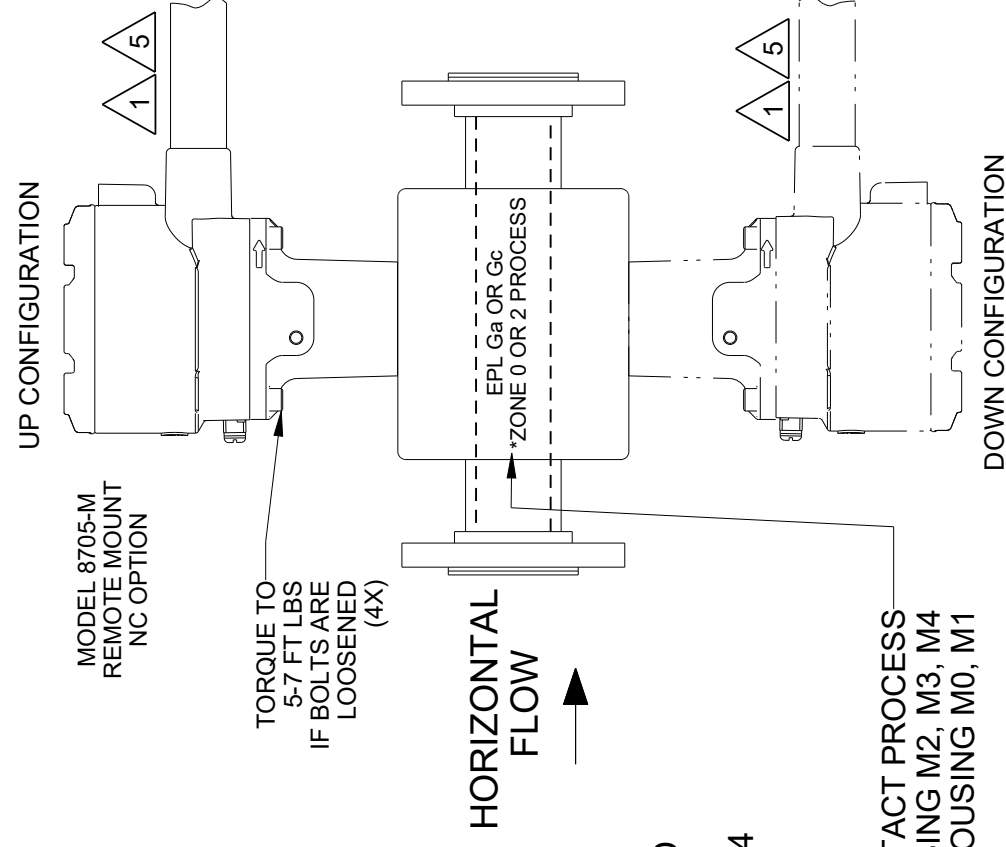

MODEL 8711-L REMOTE CONFIGURATION
WITH SAFETY APPROVAL OPTION 'NC'

MODEL CODE BREAKDOWN  3
8711xxxxlx[NC] 8711-L

SAFETY APPROVALS OPTION
MOUNTING CODE REMOTE (L)

Ex nA ic IIC T5 ... T3 Gc
Ex ec ic IIC T5... T3 Gc
EPL Gc, FOR USE IN HAZARDOUS (Ex) AREA - ZONE 2
WITH CARBON STEEL HOUSING: (-29°C ≤ Ta ≤ 60°C)
WITH STAINLESS STEEL HOUSING: (-50°C ≤ Ta ≤ 60°C)
SEE TABLE 4 FOR PROCESS TEMPERATURE LIMITS AND ALLOWED
MOUNTING CONFIGURATIONS
TYPE 'e' OR TYPE 'n' PROTECTION WITH INTRINSICALLY
SAFE ELECTRODES

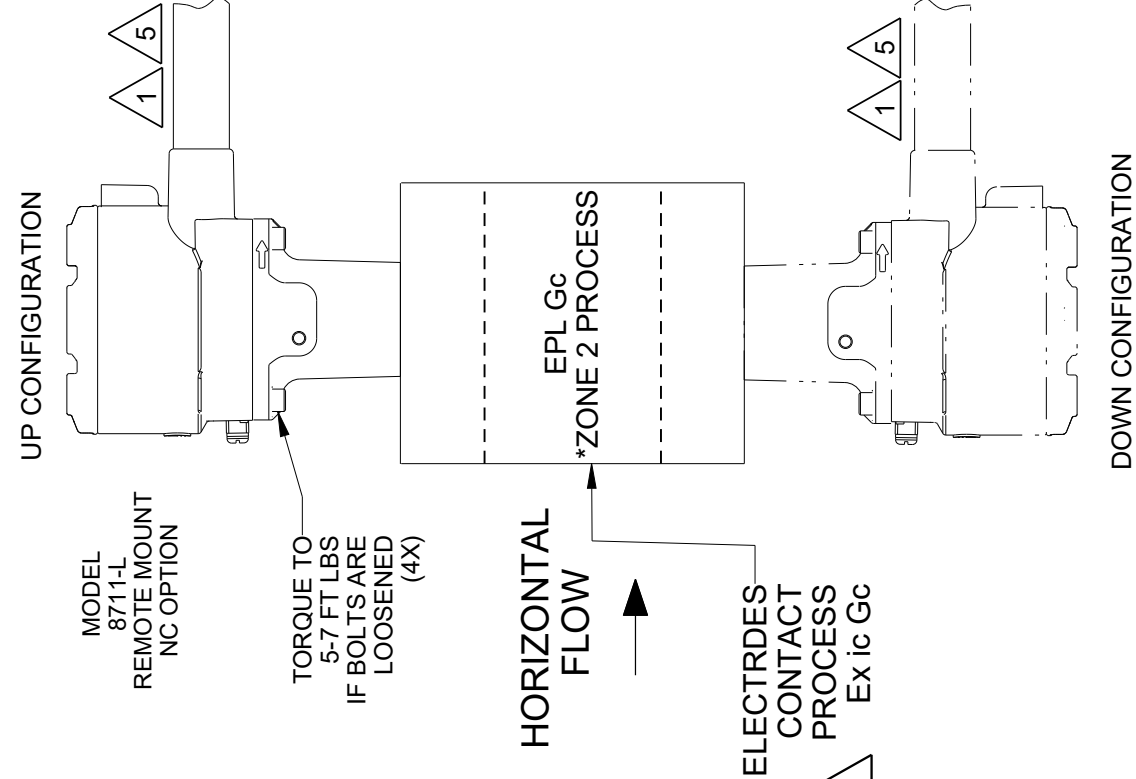

ALLOWED REMOTE MOUNT TRANSMITTER CONFIGURATIONS

MODEL 8732EM REMOTE MOUNT CONFIGURATION
WITH SAFETY APPROVAL OPTION 'K6'

MODEL CODE BREAKDOWN  3
8732EMRxxx[K6] 8732EM

SAFETY APPROVALS OPTION
MOUNTING CODE REMOTE (R)
TRANSMITTER CLASS

Ex db eb [ja Ga] IIC T6... T3 Gb
EPL Gb, FOR USE IN ZONE 1 OR 2
TEMPERATURE CLASS EPL Gb: T6 (-50°C ≤ Ta ≤ 60°C)
FLAMEPROOF ELECTRONICS HOUSING, INCREASED SAFETY
TERMINAL BLOCK WITH INTRINSICALLY SAFE ELECTRODE
CIRCUIT, INCREASED SAFETY REMOTE JUNCTION BOX.

MODEL 8732EM REMOTE MOUNT CONFIGURATION
WITH SAFETY APPROVAL OPTION 'NC'

MODEL CODE BREAKDOWN  3
8732EMRxxx[NC] 8732EM

SAFETY APPROVALS OPTION
MOUNTING CODE REMOTE (R)
TRANSMITTER CLASS

Ex nA [ja Ga] IIC T4 ... T3 Gc - DC POWER ONLY, IN PROTECTION TYPE 'n'
Ex ec [ja Ga] IIC T4... T3 Gc - DC POWER ONLY, IN PROTECTION TYPE 'e'
EPL Gc, FOR USE IN ZONE 2
TEMPERATURE CLASS: EPL Gc: T4 (-50°C ≤ Ta ≤ 60°C)
WITH INTRINSICALLY SAFE ELECTRODE CIRCUIT.

MODEL 8712EM REMOTE MOUNT CONFIGURATION
WITH SAFETY APPROVAL OPTION 'NC'

MODEL CODE BREAKDOWN  3
8712EMRxxx[NC] 8712EM

SAFETY APPROVALS OPTION
MOUNTING CODE REMOTE (R)
TRANSMITTER CLASS

Ex nA ic [ja Ga] IIC T4 Gc - DC POWER ONLY, IN PROTECTION TYPE 'n'
Ex ec ic [ja Ga] IIC T4 Gc - DC POWER, IN PROTECTION TYPE 'e'
EPL Gc, FOR USE IN ZONE 2
TEMPERATURE CLASS: EPL Gc: T4 (-40°C ≤ Ta ≤ 60°C)
WITH INTRINSICALLY SAFE ELECTRODE CIRCUIT.

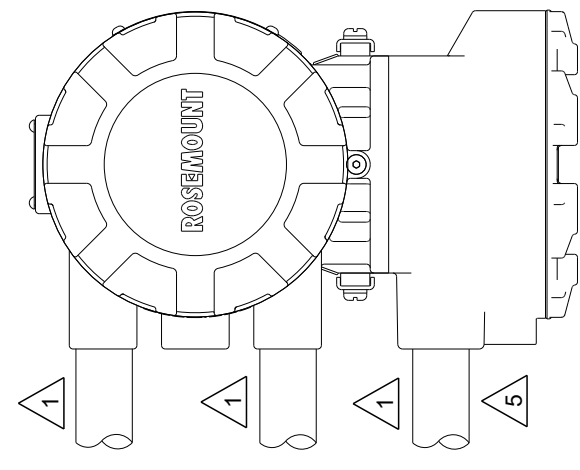

MODEL 8732EM
REMOTE MOUNT
NC OPTION

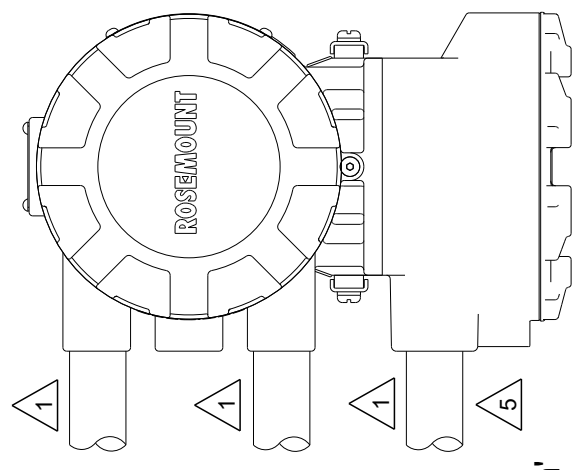

MODEL 8732EM
REMOTE MOUNT
NC OPTION

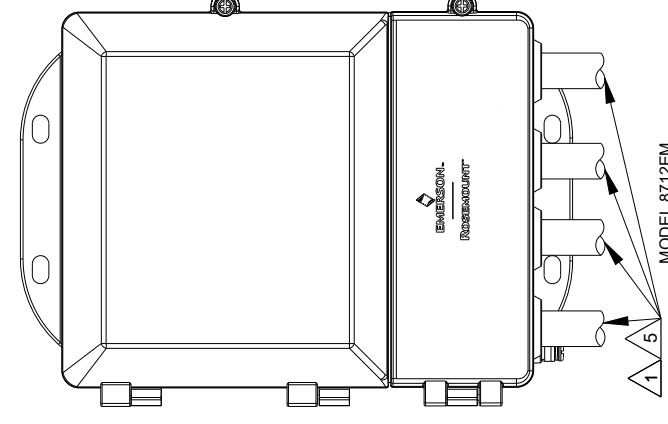

MODEL 8712EM
REMOTE MOUNT
NC OPTION

CONFIDENTIAL AND PROPRIETARY INFORMATION IS CONTAINED HEREIN AND MUST BE HANDLED ACCORDINGLY.	SURFACE FINISH UNLESS OTHERWISE SPECIFIED	125	3RD ANGLE	SIZE	C	SCALE	-	REV	AD
UNLESS OTHERWISE SPECIFIED DIMENSIONS IN INCHES (mm). REMOVE ALL BURRS AND SHARP EDGES.	EMERSON								
-DEC TOLERANCES-	ROSEMOUNT								
X ± .1 [2.5]	TITLE								
.XX ± .02 [0.5]	INSTALLATION DRAWING								
.XXX ± .010 [0.25]	ROSEMOUNT								
FRACTIONS ± 1/32	CSA CANADIAN AND USA ZONE								
ANGLES ± 2'	DR. N. BOND 2/18/14 DRAWING NO. 08732-2066								
DO NOT SCALE PRINT	CAD MAINTAINED, (PROE)	PRODUCT CODE	DOC TYPE	SHEET6	OF 15				

* TYPICAL APPLICATION: CONSULT LOCAL HAZARDOUS AREA (EX) ZONING FOR PROCESS FLUID CLASSIFICATION.

GAS ENVIRONMENT - EPL Ga/Gc SENSOR TEMPERATURE CODE VS. PROCESS TEMPERATURE

TABLE 3 - 8705-M/L: Ex ec or Ex nA - PROTECTION TYPE 'e' OR TYPE 'n'
SAFETY APPROVAL OPTIONS 'NC'
ALLOWED TRANSMITTER MOUNTING AND TEMPERATURE CODE VS. PROCESS TEMPERATURE

Line Size	Maximum Process Temperature (°C)	Temperature Code	Transmitter Mounting
0.5"	60	T5	Integral/Remote
	120	T4	Integral/Remote
	180	T3	Remote
1"	60	T5	Integral/Remote
	120	T4	Integral/Remote
	180	T3	Remote
1.5"	60	T5	Integral/Remote
	105	T4	Integral/Remote
	170	T3	Remote
2"	60	T5	Integral/Remote
	105	T4	Integral/Remote
	170	T3	Remote
2.5"	60	T5	Integral/Remote
	110	T4	Remote
	170	T3	Remote
3"	60	T5	Integral/Remote
	115	T4	Remote
	175	T3	Remote
4"	60	T5	Integral/Remote
	115	T4	Remote
	175	T3	Remote
5"	60	T5	Integral/Remote
	120	T4	Remote
	175	T3	Remote
6"	60	T5	Integral/Remote
	120	T4	Remote
	180	T3	Remote
8-36"	60	T5	Integral/Remote
	120	T4	Remote
	180	T3	Remote**

**LINE SIZES 8" AND GREATER SHOULD BE MOUNTED WITH REMOTE JUNCTION BOX (RJB) DOWN OR TO THE SIDE

TABLE 4 - 8711-M/L: Ex ec or Ex nA - PROTECTION TYPE 'e' OR TYPE 'n'
SAFETY APPROVAL OPTIONS 'NC'
ALLOWED TRANSMITTER MOUNTING AND TEMPERATURE CODE VS. PROCESS TEMPERATURE

Line Size	Maximum Process Temperature (°C)	Temperature Code	Junction Box Orientation	Transmitter Mounting
1.5"	60	T5	Any	Integral/Remote
	100	T4	Any	Remote
	160	T3	Down	Remote
2"	60	T5	Any	Integral/Remote
	100	T4	Any	Remote
	160	T3	Down	Remote
3"	60	T5	Any	Integral/Remote
	110	T4	Any	Remote
	170	T3	Down	Remote
4"	60	T5	Any	Integral/Remote
	115	T4	Any	Remote
	175	T3	Down	Remote
6"	60	T5	Any	Integral/Remote
	115	T4	Any	Remote
	180	T3	Down	Remote
8"	60	T5	Any	Integral/Remote
	115	T4	Any	Remote
	180	T3	Down	Remote

08732-2066

DRAWING NO.

CONFIDENTIAL AND PROPRIETARY INFORMATION IS CONTAINED HEREIN AND MUST BE HANDLED ACCORDINGLY.	SURFACE FINISH UNLESS OTHERWISE SPECIFIED $\sqrt{}$	3RD ANGLE	SIZE C	SCALE -	REV AD
EMERSON TITLE ROSEMOUNT INSTALLATION DRAWING CSA CANADIAN AND USA ZONE					
UNLESS OTHERWISE SPECIFIED DIMENSIONS IN INCHES (mm). REMOVE ALL BURRS AND SHARP EDGES.					
-DEC TOLERANCES- X ± .1 [2.5] .XX ± .02 [0.5] .XXX ± .010 [0.25] FRACTIONS ± 1/32 ANGLES ± 2°					
DO NOT SCALE PRINT		CAD MAINTAINED (PROJ)		PRODUCT CODE	
DR. N. BOND 2/18/14		DRAWING NO. 08732-2066		DOC TYPE SHEET 7 OF 15	

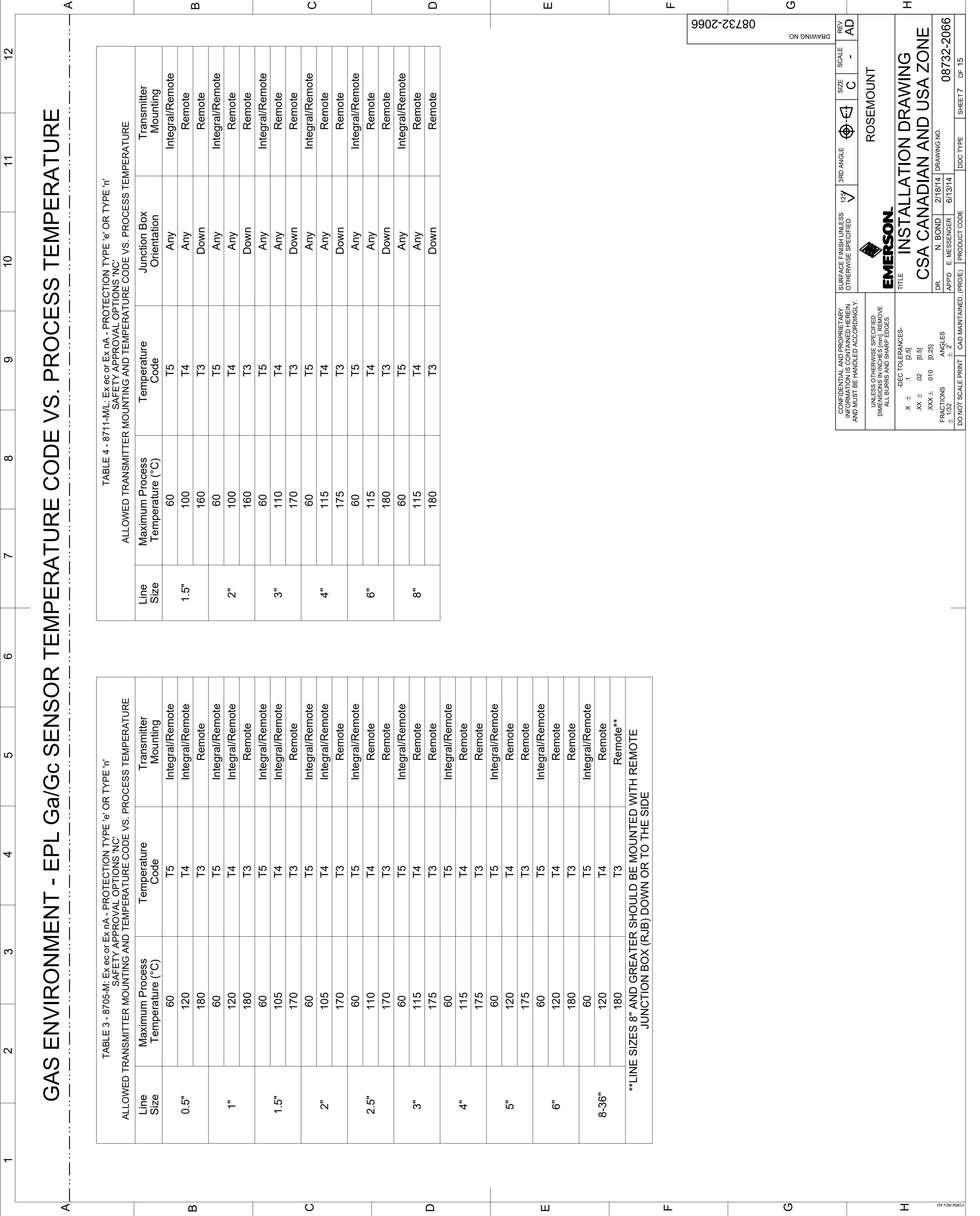

DUST ENVIRONMENT- EPL Db SENSOR WITH ALLOWED INTEGRAL MOUNT EPL Db TRANSMITTERS

Ex tb SENSOR INTEGRAL MOUNT CONFIGURATIONS

MODEL 8705-M INTEGRAL MOUNT CONFIGURATION WITH SAFETY APPROVALS OPTIONS 'K6' OR 'NC'

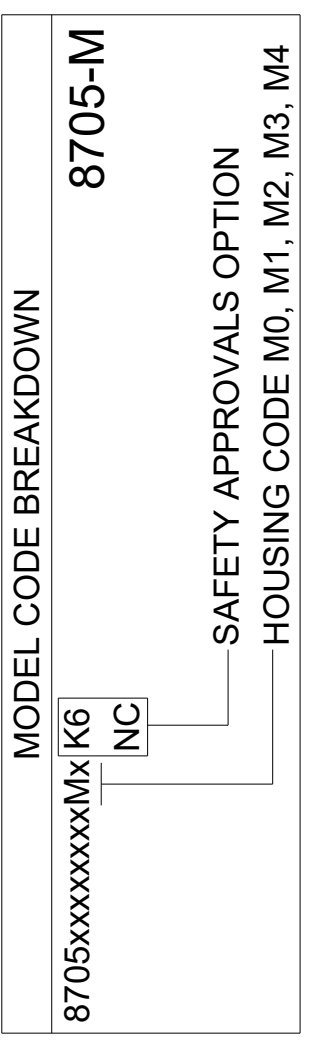

Ex tb IIC T80 °C...T200 °C Db
EPL Db, FOR USE IN ZONE 21
WITH CARBON STEEL HOUSING: (-29°C ≤ Ta ≤ 60°C)
WITH STAINLESS STEEL HOUSING: (-50°C ≤ Ta ≤ 60°C)
SEE TABLE 5 FOR PROCESS TEMPERATURE LIMITS AND ALLOWED MOUNTING CONFIGURATIONS

MODEL 8711-M INTEGRAL MOUNT CONFIGURATION WITH SAFETY APPROVALS OPTIONS 'K6' OR 'NC'

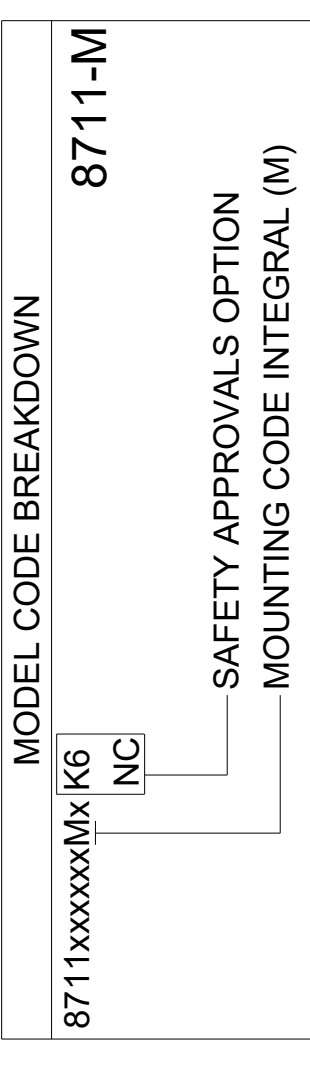

Ex tb IIC T80 °C...T200 °C Db
EPL Db, FOR USE IN ZONE 21
WITH CARBON STEEL HOUSING: (-29°C ≤ Ta ≤ 60°C)
WITH STAINLESS STEEL HOUSING: (-50°C ≤ Ta ≤ 60°C)
SEE TABLE 6 FOR PROCESS TEMPERATURE LIMITS AND ALLOWED MOUNTING CONFIGURATIONS

ALLOWED INTEGRAL MOUNT TRANSMITTER CONFIGURATIONS

MODEL 8732EM INTEGRAL MOUNT CONFIGURATION WITH SAFETY APPROVALS OPTIONS 'K6' OR 'NC'

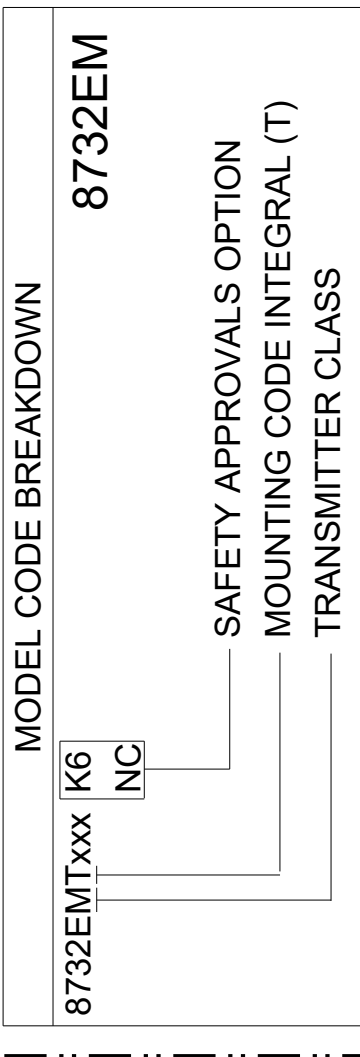

Ex tb IIC T 80 °C...T 200 °C Db
Ex tb IIC T80 °C...T200 °C Db
EPL Db, FOR USE IN ZONE 21
SEE TABLE 5 OR TABLE 6 TEMPERATURE CLASS AND SPECIFIED MAXIMUM SURFACE TEMPERATURE "T" OF FLOWTUBES ON WHICH THE TRANSMITTER IS MOUNTED.

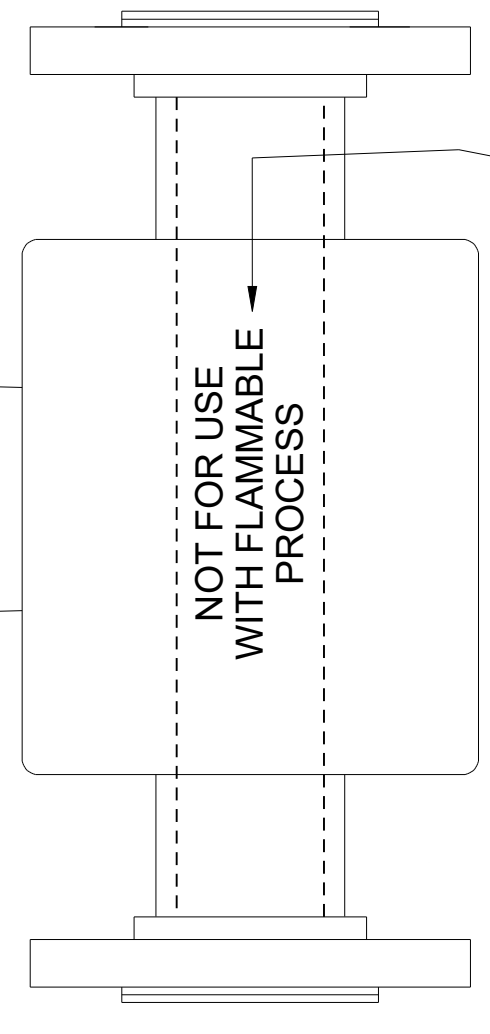
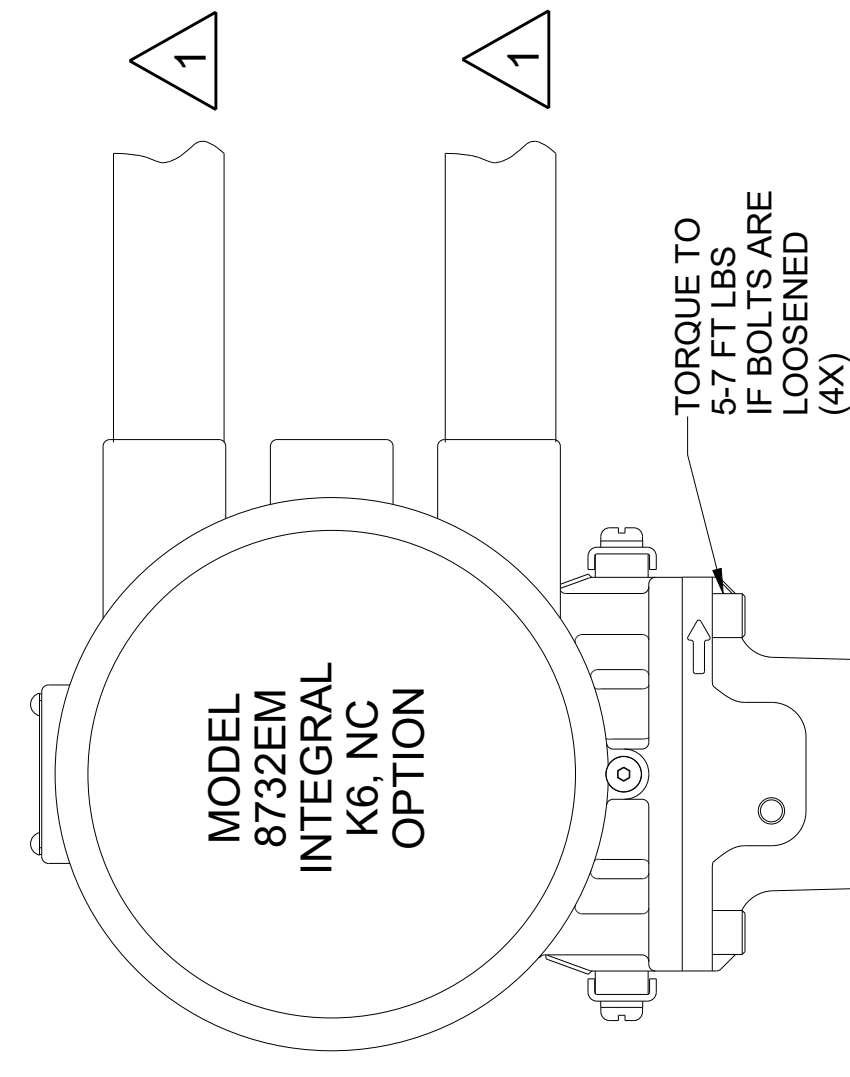

MODEL 8705-M INTEGRAL K6, NC OPTION

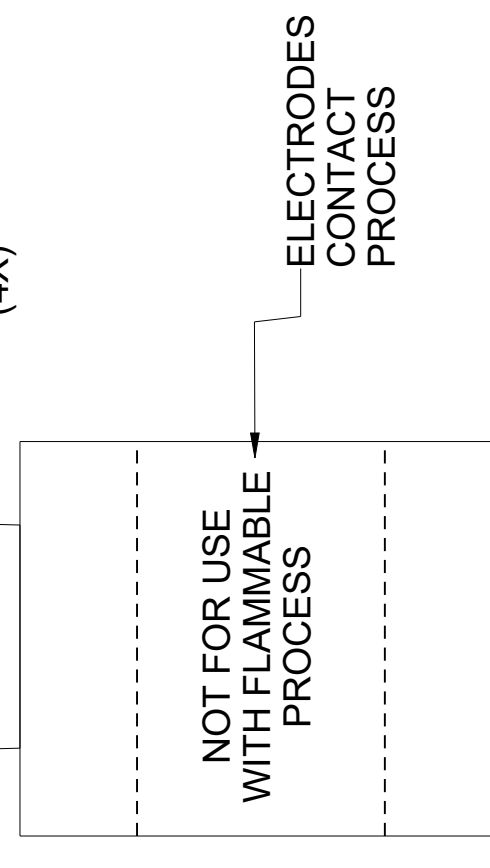
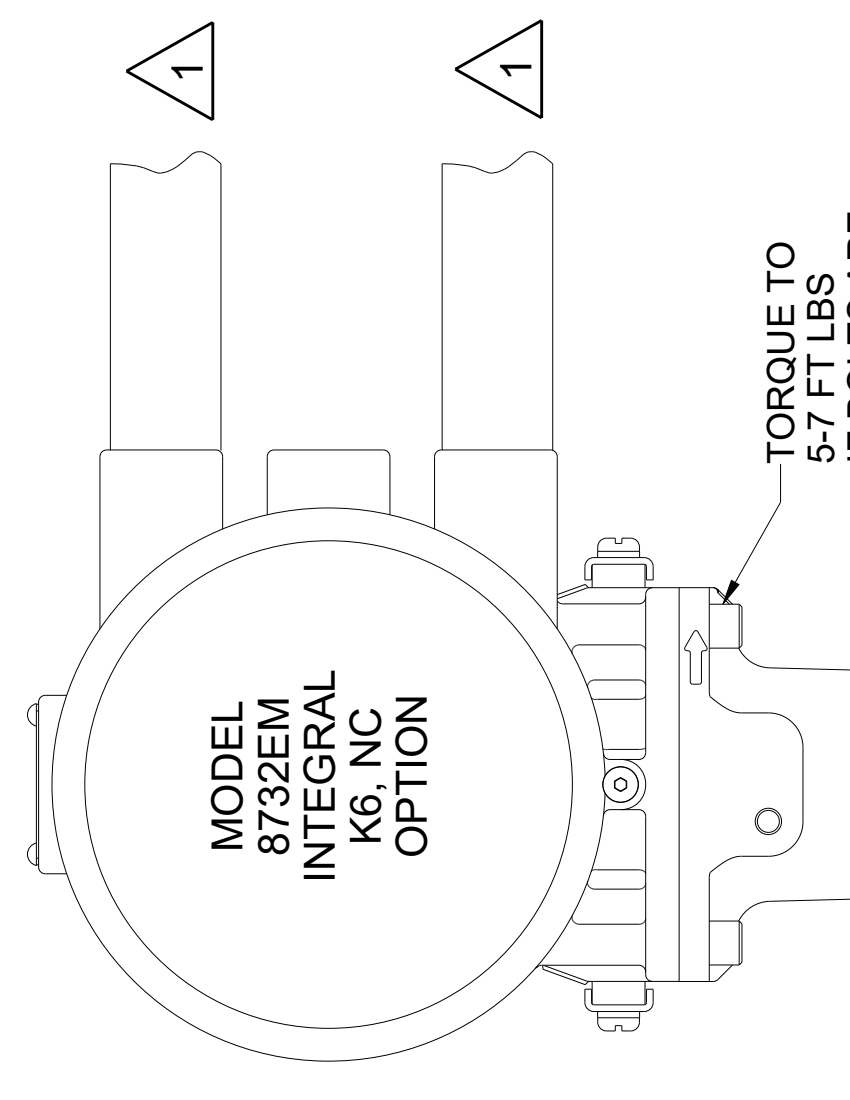

MODEL 8711-M INTEGRAL K6, NC OPTION

08732-2066
DRAWING NO.

CONFIDENTIAL AND PROPRIETARY INFORMATION IS CONTAINED HEREIN AND MUST BE HANDLED ACCORDINGLY.	SURFACE FINISH UNLESS OTHERWISE SPECIFIED	125	3RD ANGLE	SIZE	C	SCALE	-	REV	AD
UNLESS OTHERWISE SPECIFIED DIMENSIONS IN INCHES (mm). REMOVE ALL BURRS AND SHARP EDGES.	EMERSON								
-DEC TOLERANCES-	ROSEMOUNT								
X ± .1 [2.5]	TITLE								
.XX ± .02 [0.5]	INSTALLATION DRAWING								
.XXX ± .010 [0.25]	CSA CANADIAN AND USA ZONE								
FRACTIONS ± 1/32	DR. N. BOND 2/18/14 DRAWING NO. 08732-2066								
ANGLES ± 2'	APPD. E. MESSENGER 6/13/14								
DO NOT SCALE PRINT	CAD MAINTAINED (PROJ) PRODUCT CODE SHEET8 OF 15								

DUST ENVIRONMENT - EPL Db SENSOR WITH ALLOWED REMOTE MOUNT EPL Db TRANSMITTERS

Ex tb SENSOR REMOTE MOUNT CONFIGURATIONS

MODEL 8705-M REMOTE CONFIGURATION
WITH SAFETY APPROVALS OPTIONS 'K6' OR 'NC'

MODEL CODE BREAKDOWN

8705xxxxxxMx|K6|NC

SAFETY APPROVALS OPTION
HOUSING CODE M0, M1, M2, M3, M4

Ex tb IIC T80 °C...T200 °C Db
EPL Db, FOR USE IN ZONE 21
WITH CARBON STEEL HOUSING: (-29°C ≤ Ta ≤ 60°C)
WITH STAINLESS STEEL HOUSING: (-50°C ≤ Ta ≤ 60°C)
SEE TABLE 5 FOR PROCESS TEMPERATURE LIMITS AND ALLOWED
MOUNTING CONFIGURATIONS

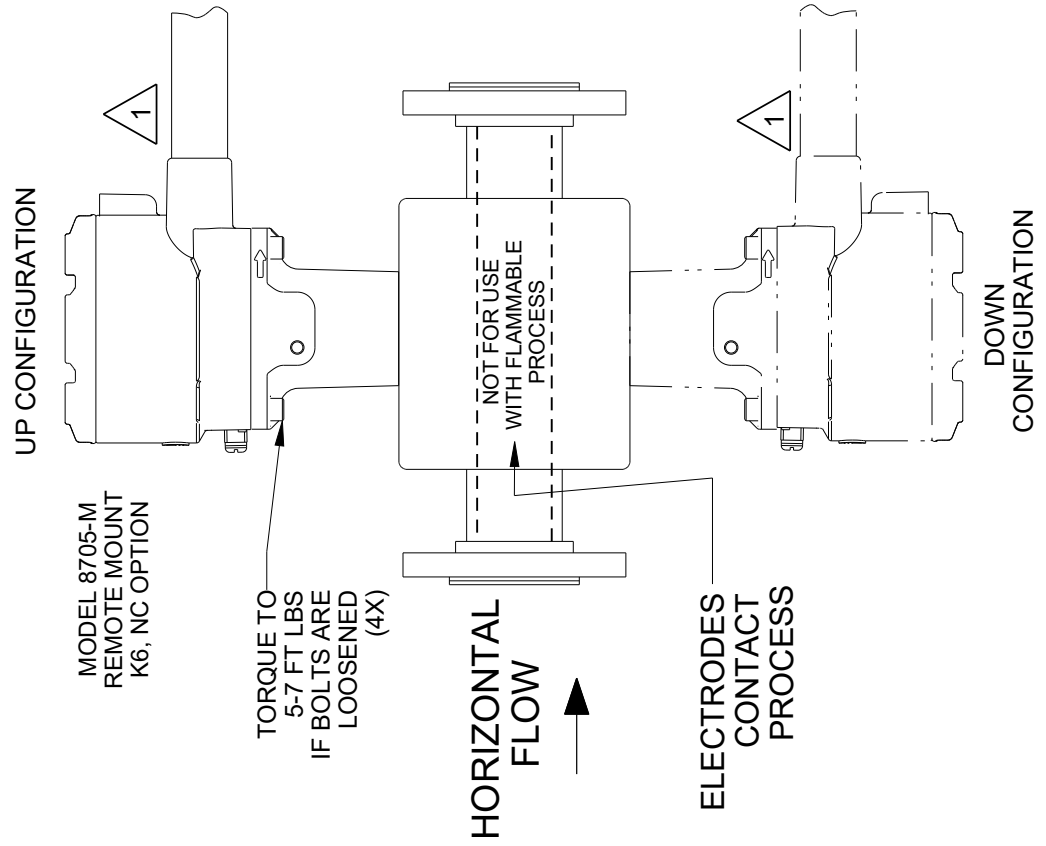

MODEL 8711-L REMOTE CONFIGURATION
WITH SAFETY APPROVALS OPTIONS 'K6' OR 'NC'

MODEL CODE BREAKDOWN

8711xxxxxxLx|K6|NC

SAFETY APPROVALS OPTION
MOUNTING CODE REMOTE (L)

Ex tb IIC T80 °C...T200 °C Db
EPL Db, FOR USE IN ZONE 21
WITH CARBON STEEL HOUSING: (-29°C ≤ Ta ≤ 60°C)
WITH STAINLESS STEEL HOUSING: (-50°C ≤ Ta ≤ 60°C)
SEE TABLE 5 FOR PROCESS TEMPERATURE LIMITS AND ALLOWED
MOUNTING CONFIGURATIONS

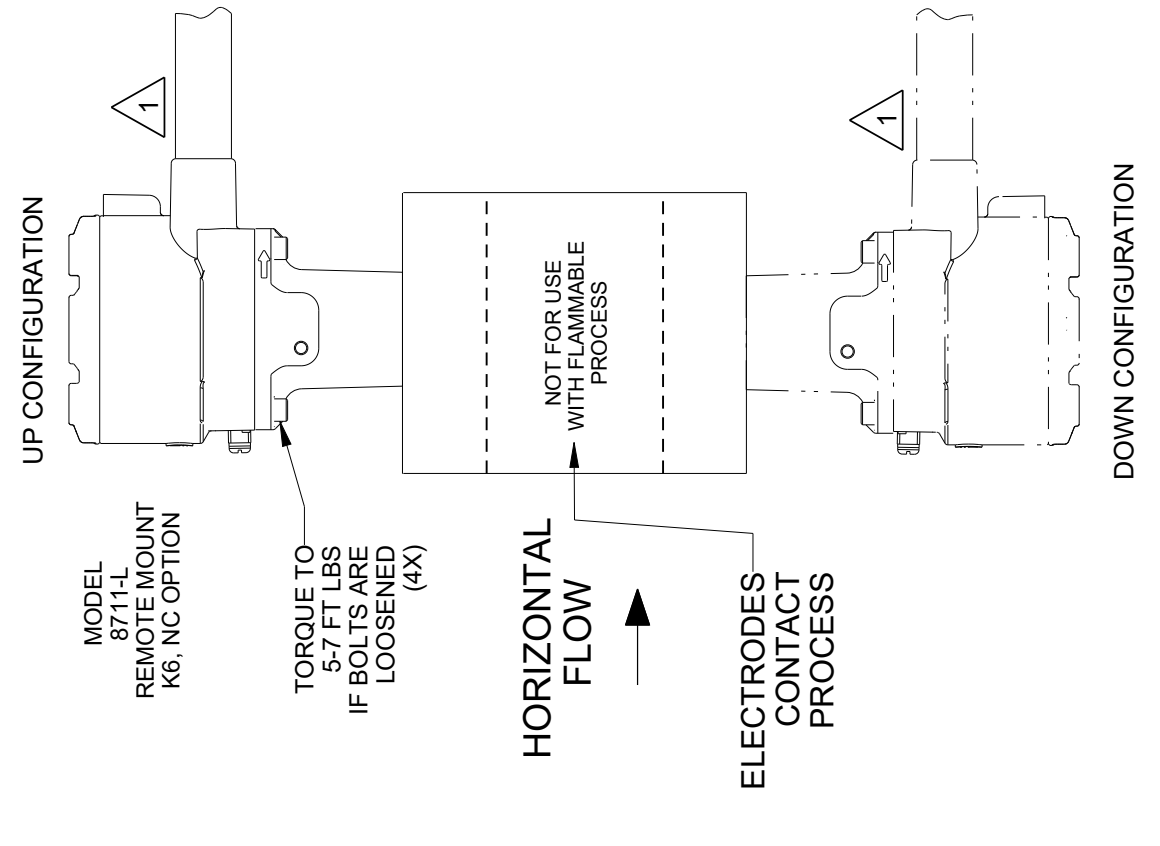

ALLOWED REMOTE MOUNT TRANSMITTER CONFIGURATIONS

MODEL 8732EM REMOTE MOUNT CONFIGURATION
WITH SAFETY APPROVALS OPTIONS 'K6' OR 'NC'

MODEL CODE BREAKDOWN

8732EMRxxx|K6|NC

SAFETY APPROVALS OPTION
MOUNTING CODE REMOTE (R)
TRANSMITTER CLASS

Ex tb IIC T 80 °C... T 200 °C Db
Ex tb [Ia Da] IIC T80 °C...T200 °C Db
EPL Db, FOR USE IN ZONE 21
REMOTE MOUNT TRANSMITTER MAXIMUM SURFACE
TEMPERATURE T80°C (-50°C ≤ Ta ≤ 60°C)

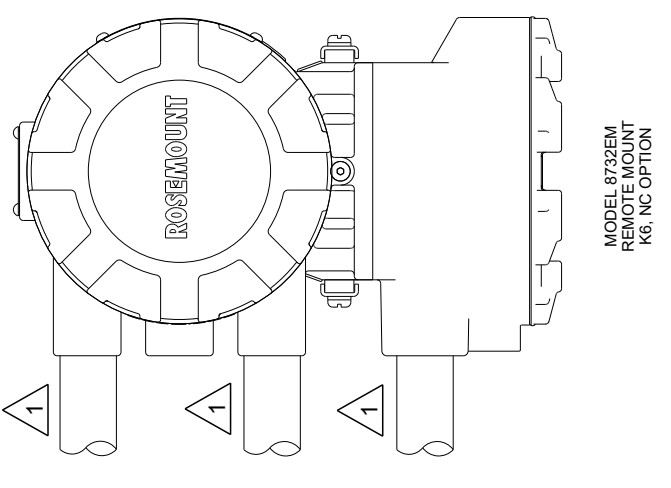

MODEL 8712EM REMOTE MOUNT CONFIGURATION
WITH SAFETY APPROVALS OPTION 'NC'

MODEL CODE BREAKDOWN

8712EMRxxx|NC

SAFETY APPROVALS OPTION
MOUNTING CODE REMOTE (R)
TRANSMITTER CLASS

Ex tb IIC T80°C Db
Ex tb [Ia Da] IIC T80°C Db
EPL Db, FOR USE IN ZONE 21
REMOTE MOUNT TRANSMITTER MAXIMUM SURFACE
TEMPERATURE T80°C (-40°C ≤ Ta ≤ 60°C)

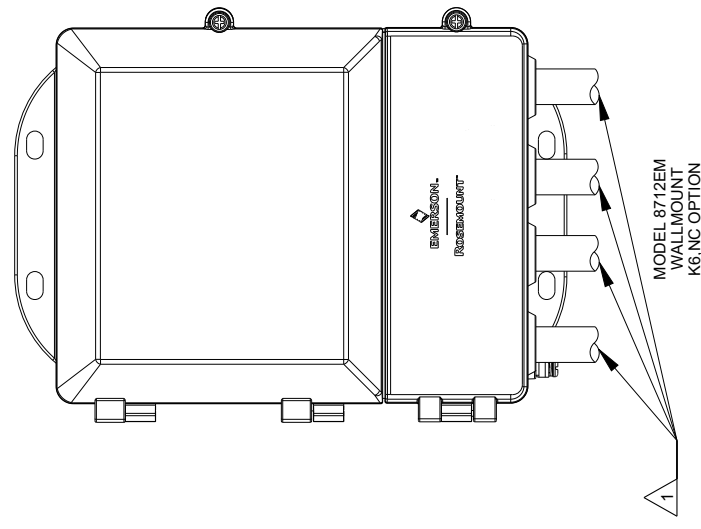

08732-2066
DRAWING NO.

CONFIDENTIAL AND PROPRIETARY INFORMATION IS CONTAINED HEREIN AND MUST BE HANDLED ACCORDINGLY.	SURFACE FINISH UNLESS OTHERWISE SPECIFIED	125	3RD ANGLE	SIZE	C	SCALE	-	REV	AD
UNLESS OTHERWISE SPECIFIED DIMENSIONS IN INCHES (mm). REMOVE ALL BURRS AND SHARP EDGES.	EMERSON ROSEMOUNT								
-DEC TOLERANCES-	TITLE INSTALLATION DRAWING CSA CANADIAN AND USA ZONE								
X ± .1 [2.5]	DR. N. BOND 2/18/14 DRAWING NO. 08732-2066								
.XX ± .02 [0.5]	APPD. E. MESSENGER 6/13/14								
.XXX ± .010 [0.25]	DO NOT SCALE PRINT CAD MAINTAINED (PROJ) PRODUCT CODE SHEET9 OF 15								
FRACTIONS ± 1/32	ANGLES ± 2°								

DUST ENVIRONMENT - EPL Db SENSOR TEMPERATURE CODE VS. PROCESS TEMPERATURE

**TABLE 5 - 8705-M: Ex tb PROTECTION BY ENCLOSURE 't'
SAFETY APPROVAL OPTIONS 'K6' AND 'NC'
ALLOWED TRANSMITTER MOUNTING AND TEMPERATURE CODE VS. PROCESS TEMPERATURE**

Line Size	Maximum Process Temperature (°C)	Dust Temperature Code	Transmitter Mounting
0.5"	60	T 80°C	Integral/Remote
	90	T 110°C	Integral/Remote
	120	T 140°C	Integral/Remote
	180	T 200°C	Remote
1"	60	T 80°C	Integral/Remote
	90	T 110°C	Integral/Remote
	120	T 140°C	Integral/Remote
	180	T 200°C	Remote
1.5"	60	T 80°C	Integral/Remote
	90	T 110°C	Integral/Remote
	105	T 125°C	Integral/Remote
	170	T 190°C	Remote
2"	60	T 80°C	Integral/Remote
	90	T 110°C	Integral/Remote
	105	T 125°C	Integral/Remote
	170	T 190°C	Remote
2.5"	60	T 80°C	Integral/Remote
	90	T 110°C	Integral/Remote
	110	T 130°C	Remote
	170	T 190°C	Remote
3"	60	T 80°C	Integral/Remote
	90	T 110°C	Remote
	115	T 135°C	Remote
	175	T 195°C	Remote
4"	60	T 80°C	Integral/Remote
	90	T 110°C	Remote
	115	T 135°C	Remote
	175	T 195°C	Remote
5"	60	T 80°C	Integral/Remote
	90	T 110°C	Remote
	120	T 140°C	Remote
	175	T 195°C	Remote
6"	60	T 80°C	Integral/Remote
	90	T 110°C	Remote
	120	T 140°C	Remote
	180	T 200°C	Remote
8-36"	60	T 80°C	Integral/Remote
	90	T 110°C	Remote
	120	T 140°C	Remote
	180	T 200°C	Remote**

****LINE SIZES 8" AND GREATER SHOULD BE MOUNTED WITH REMOTE JUNCTION BOX (RJB) DOWN OR TO THE SIDE**

**TABLE 6 - 8711-M/L: Ex tb PROTECTION BY ENCLOSURE 't'
SAFETY APPROVAL OPTIONS 'K6' AND 'NC'
ALLOWED TRANSMITTER MOUNTING AND TEMPERATURE CODE VS. PROCESS TEMPERATURE**

Line Size	Maximum Process Temperature (°C)	Dust Temperature Code	Junction Box Orientation	Transmitter Mounting
1.5"	60	T 80°C	Any	Integral/Remote
	80	T 100°C	Any	Remote
	100	T 120°C	Any	Remote
	160	T 180°C	Down Only	Remote
2"	60	T 80°C	Any	Integral/Remote
	80	T 100°C	Any	Remote
	100	T 120°C	Any	Remote
	160	T 180°C	Down Only	Remote
3"	60	T 80°C	Any	Integral/Remote
	80	T 100°C	Any	Remote
	110	T 130°C	Any	Remote
	170	T 190°C	Down Only	Remote
4"	60	T 80°C	Any	Integral/Remote
	80	T 100°C	Any	Remote
	115	T 135°C	Any	Remote
	175	T 195°C	Down Only	Remote
6"	60	T 80°C	Any	Integral/Remote
	80	T 100°C	Any	Remote
	115	T 135°C	Any	Remote
	180	T 200°C	Down Only	Remote
8"	60	T 80°C	Any	Integral/Remote
	80	T 100°C	Any	Remote
	115	T 135°C	Any	Remote
	180	T 200°C	Down Only	Remote

DRAWING NO. 08732-2066

CONFIDENTIAL AND PROPRIETARY INFORMATION IS CONTAINED HEREIN AND MUST BE HANDLED ACCORDINGLY.	SURFACE FINISH UNLESS OTHERWISE SPECIFIED		3RD ANGLE	SIZE	SCALE	REV
UNLESS OTHERWISE SPECIFIED DIMENSIONS IN INCHES (mm). REMOVE ALL BURRS AND SHARP EDGES.						
-DEC TOLERANCES- X ± .1 [2.5] .XX ± .02 [0.5] .XXX ± .010 [0.25] FRACTIONS ± 1/32 ANGLES ± 2'	EMERSON ROSEMOUNT					
TITLE INSTALLATION DRAWING CSA CANADIAN AND USA ZONE						
DR. N. BOND 2/18/14 DRAWING NO. 08732-2066 APPD. E. MESSENGER 6/13/14						
DO NOT SCALE PRINT CAD MAINTAINED (PROJ) PRODUCT CODE	SHEET 10 OF 15					

GAS ENVIRONMENT-COIL AND ELECTRODE CIRCUIT WIRING

MODEL 8732EM WITH INTRINSICALLY SAFE ELECTRODE CIRCUIT FOR USE WITH 8705-M OR 8711-L WITH SAFETY APPROVAL OPTIONS K6 OR NC

DIVIDER REQUIRED FOR INTRINSIC SAFETY (Ex i)

COMPONENT CABLES ONLY. SEE TABLE BELOW FOR COMPATIBLE WIRING. SEE INSTALLATION WIRING DRAWING 08732-1504 FOR CABLING DETAILS. (FOR PROCESS TEMPERATURE LIMITS SEE TABLES 1-4)

NON-INTRINSICALLY SAFE COIL CIRCUIT WIRING OPTIONS:
INSTALL AS Ex eb - "TYPE 'e' INCREASED SAFETY" OR
INSTALL AS Ex na - "TYPE 'n' NON-SPARKING" OR
INSTALL AS Ex ec - "TYPE 'e' INCREASED SAFETY"

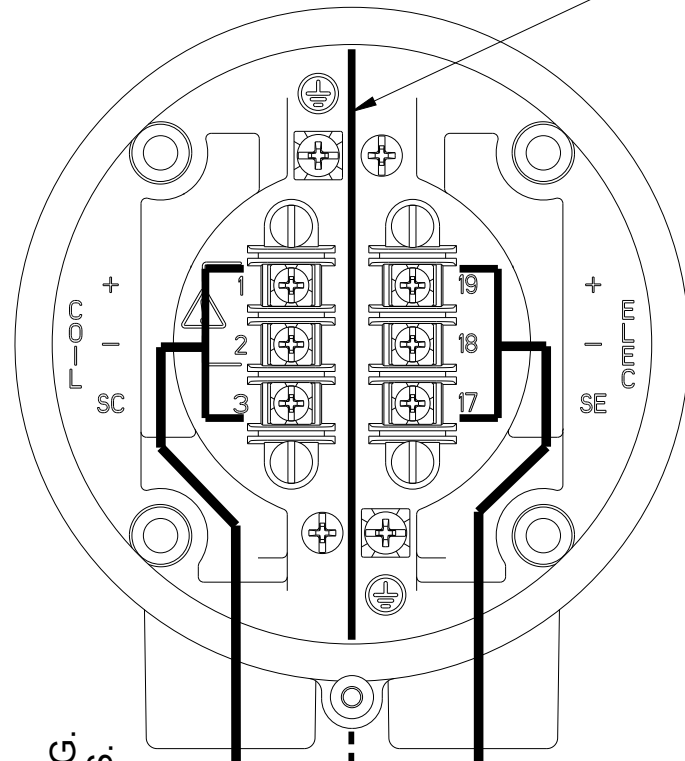

5 INTRINSICALLY SAFE ELECTRODE CIRCUIT SEGREGATE FROM NON-INTRINSICALLY SAFE WIRING

8705-M OR 8711-L FLOWTUBE REMOTE JUNCTION BOX

DIVIDER REQUIRED FOR INTRINSIC SAFETY (Ex i)

8732EM TRANSMITTER REMOTE JUNCTION BOX

MODEL 8712EM WITH INTRINSICALLY SAFE ELECTRODE CIRCUIT FOR USE WITH 8705-M OR 8711-L WITH SAFETY APPROVAL OPTIONS K6 OR NC

DIVIDER REQUIRED FOR INTRINSIC SAFETY (Ex i)

COMPONENT CABLES ONLY. SEE TABLE BELOW FOR COMPATIBLE WIRING. SEE INSTALLATION WIRING DRAWING 08712-1504 FOR CABLING DETAILS. (FOR PROCESS TEMPERATURE LIMITS SEE TABLES 1-4)

NON-INTRINSICALLY SAFE COIL CIRCUIT WIRING OPTIONS:
INSTALL AS Ex na - "TYPE 'n' NON-SPARKING" OR
INSTALL AS Ex ec - "TYPE 'e' INCREASED SAFETY"

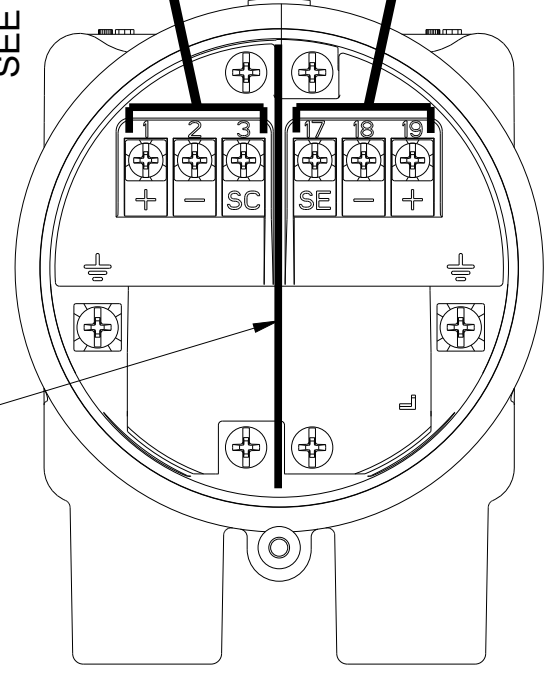

5 INTRINSICALLY SAFE ELECTRODE CIRCUIT SEGREGATE FROM NON-INTRINSICALLY SAFE WIRING

8705-M OR 8711-L FLOWTUBE REMOTE JUNCTION BOX

8712EM TRANSMITTER (LOWER COVER AND SAFETY COVER ARE NOT SHOWN)

ENTITY CONCEPT FOR INTRINSICALLY SAFE ELECTRODE INSTALLATION

SYSTEM APPROVAL FOR INTRINSICALLY SAFE ELECTRODE INSTALLATION

THE MODEL 8732EM, 8712EM, AND MODEL 8705-M OR MODEL 8711-L MAGNETIC FLOWMETER REFERENCING CONTROL DRAWING 08732-2066 MAY USE UP TO 500 FEET (150 METERS) OF ROSEMOUNT SUPPLIED ELECTRODE CABLING FOR INTERCONNECTION OF THE DEVICES. THE CORRECT CABLING IS SUPPLIED AS PART OF THE FOLLOWING ROSEMOUNT CABLING KITS:

COIL AND INTRINSICALLY SAFE ELECTRODE COMPONENT CABLES:

ROSEMOUNT PART NO.	UNIT OF MEASURE	TEMPERATURE RANGE	SEE NOTE
08732-0065-0003	FEET	-20° C TO 75° C	11
08732-0065-0004	METERS	-20° C TO 75° C	
08732-0065-1003	FEET	-50° C TO 125° C	
08732-0065-1004	METERS	-50° C TO 125° C	

INDIVIDUAL OR REPLACEMENT INTRINSICALLY SAFE ELECTRODE COMPONENT CABLES:

ROSEMOUNT PART NO.	UNIT OF MEASURE	TEMPERATURE RANGE	SEE NOTE
08732-0061-0003	FEET	-20° C TO 75° C	11
08732-0061-0004	METERS	-20° C TO 75° C	
08732-0061-1003	FEET	-50° C TO 125° C	
08732-0061-1004	METERS	-50° C TO 125° C	

TERMINALS 19, 18, AND 17 CONTAIN TWO CHANNELS OF AN INTRINSICALLY SAFE CIRCUIT WITH A COMMON RETURN. ENTITY PARAMETERS SHOWN BELOW ARE THE SUMMATION OF BOTH CHANNELS.

TRANSMITTER ENTITY PARAMETERS
MODEL 8732EM AND 8712EM
INTRINSICALLY SAFE ELECTRODE CIRCUIT
REMOTE JUNCTION BOX TERMINALS 19, 18, 17

$U_o = 28.56V$
 $I_o = 5.77mA$
 $P_o = 165mW$
 $C_o = 61.7nF$
 $L_o = 1.0H$

THE ENTITY CONCEPT ALLOWS INTERCONNECTION OF ASSOCIATED APPARATUS AND INTRINSICALLY SAFE APPARATUS WHEN THE FOLLOWING IS TRUE:

$U_o \leq U_i$, $I_o \leq I_i$, $P_o \leq P_i$, $C_o \geq C_i + C_{cable}$, $L_o \geq L_i + L_{cable}$
THE ALLOWED CAPACITANCE, C_o IS SHARED BETWEEN THE CIRCUITS OF TERMINALS 19, 18, AND 17. CABLE CAPACITANCE MUST BE ASSESSED AS TWICE THE MEASURED VALUE PER LENGTH OF CABLE.

EXAMPLE 1: THE HIGHEST MEASURED CAPACITANCE OF A 3 CONDUCTOR, SHIELDED CABLE IS 58pF/ft WHEN MEASURED CONDUCTOR TO CONDUCTOR TIED TO SHIELD.

$C_{cable} = 2 \times 58pF/ft \times \text{FEET OF CABLE}$
 $C_i + C_{cable} < C_o$
CABLE LENGTH MUST BE UNDER 515 FEET

08732-2066

DRAWING NO.

CONFIDENTIAL AND PROPRIETARY INFORMATION IS CONTAINED HEREIN AND MUST BE HANDLED ACCORDINGLY.

UNLESS OTHERWISE SPECIFIED DIMENSIONS IN INCHES (mm). REMOVE ALL BURRS AND SHARP EDGES.

-DEC TOLERANCES-	
X ± .1	[2.5]
.XX ± .02	[0.5]
.XXX ± .010	[0.25]
FRACTIONS ± 1/32	ANGLES ± 2°

SURFACE FINISH UNLESS OTHERWISE SPECIFIED

125° 3RD ANGLE

SIZE C

SCALE -

REV AD

ROSEMOUNT



TITLE
INSTALLATION DRAWING
CSA CANADIAN AND USA ZONE

DR. N. BOND 2/18/14 DRAWING NO. 08732-2066
APPD. E. MESSENGER 6/13/14

DO NOT SCALE PRINT | CAD MAINTAINED. (PROE) | PRODUCT CODE | SHEET 11 OF 15

DUST ENVIRONMENT- COIL AND ELECTRODE CIRCUIT WIRING

MODEL 8732EM WITH NON-INTRINSICALLY SAFE ELECTRODE CIRCUIT FOR USE WITH MODEL 8705-M OR 8711-L WITH SAFETY APPROVAL OPTIONS K6, NC

COMPONENT OR COMBINATION COIL/ELECTRODE CABLE ALLOWED.
SEE INSTALLATION WIRING DRAWING 08732-1504 FOR NON-INTRINSICALLY SAFE CABLING
(FOR PROCESS TEMPERATURE LIMITS SEE TABLES 5 AND 6)

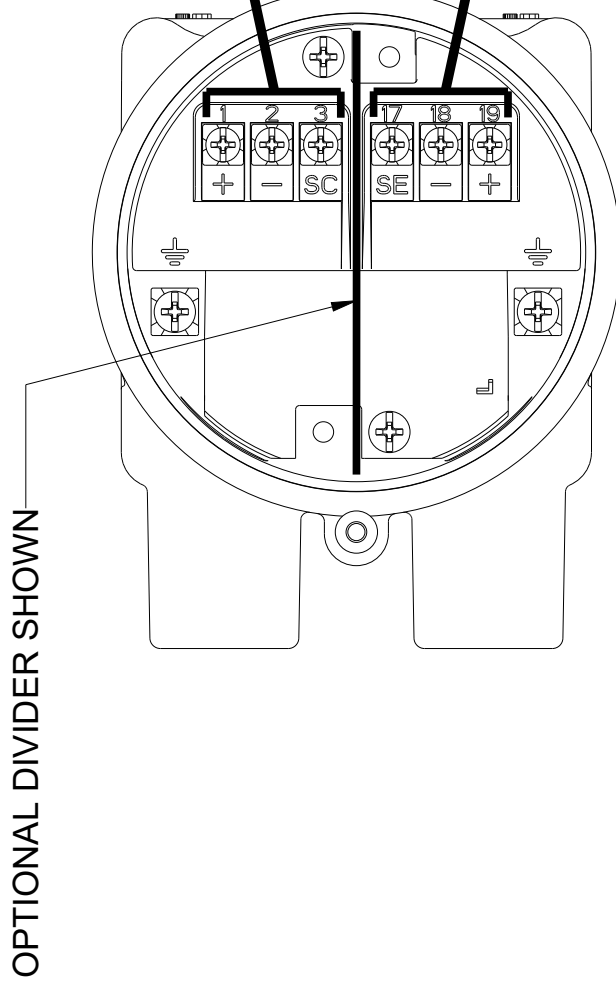

8705-M OR 8711-L FLOWTUBE
REMOTE JUNCTION BOX

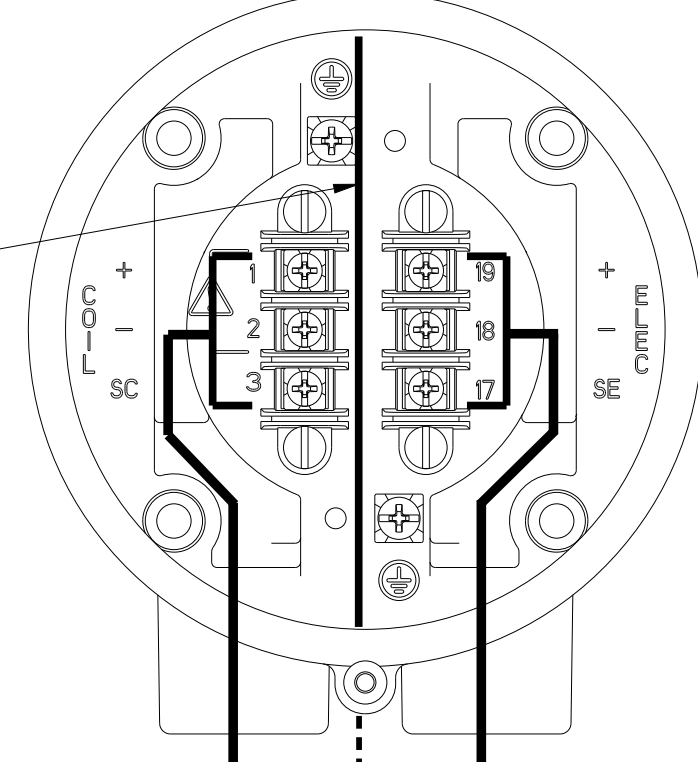

8732EM TRANSMITTER
REMOTE JUNCTION BOX

TERMINAL	LABEL
NON-INTRINSICALLY SAFE ELECTRODE CIRCUIT	
19	ELECTRODE +
18	ELECTRODE -
17	ELECTRODE REFERENCE (SE)
NON-INTRINSICALLY SAFE COIL CIRCUIT	
1	COIL +
2	COIL -
3	COIL SHIELD (SC)

NON-INTRINSICALLY SAFE COIL CIRCUIT
INSTALL USING EPL D_b WIRING
METHODS APPROPRIATE TO THE AREA DEVICE
IS INSTALLED IN

FOR USE WITH NON-FLAMMABLE PROCESS ONLY.
INSTALL ELECTRODE CIRCUIT AS NON-INTRINSICALLY SAFE
USING EPL D_b WIRING METHODS APPROPRIATE
TO THE AREA DEVICE IS INSTALLED IN.

MODEL 8712EM WITH NON-INTRINSICALLY SAFE ELECTRODE CIRCUIT FOR USE WITH MODEL 8705-M OR 8711-L WITH SAFETY APPROVAL OPTIONS K6, NC

COMPONENT OR COMBINATION COIL/ELECTRODE CABLE ALLOWED.
SEE INSTALLATION WIRING DRAWING 08712-1504 FOR NON-INTRINSICALLY SAFE CABLING
(FOR PROCESS TEMPERATURE LIMITS SEE TABLES 5 AND 6)

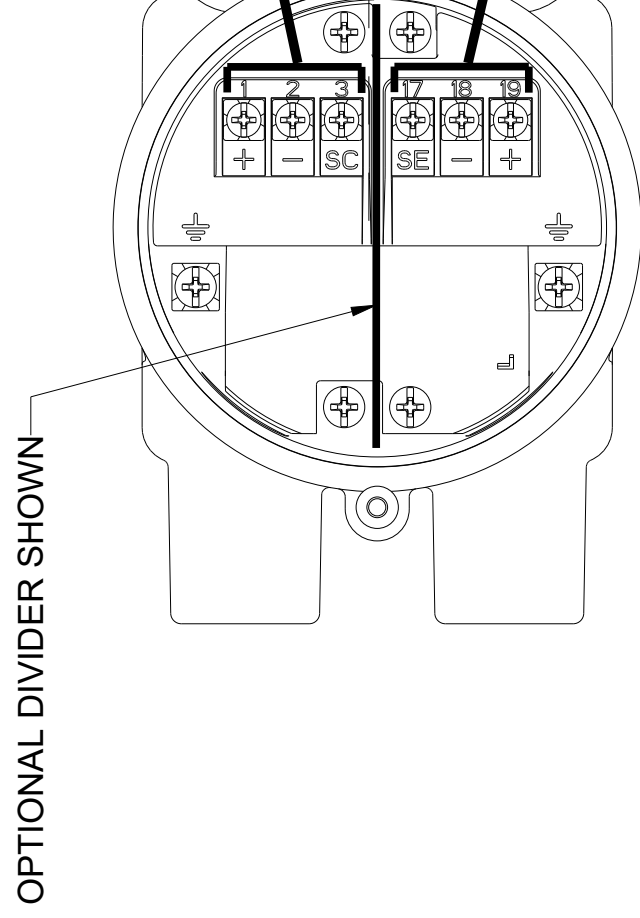

8705-M OR 8711-L FLOWTUBE
REMOTE JUNCTION BOX

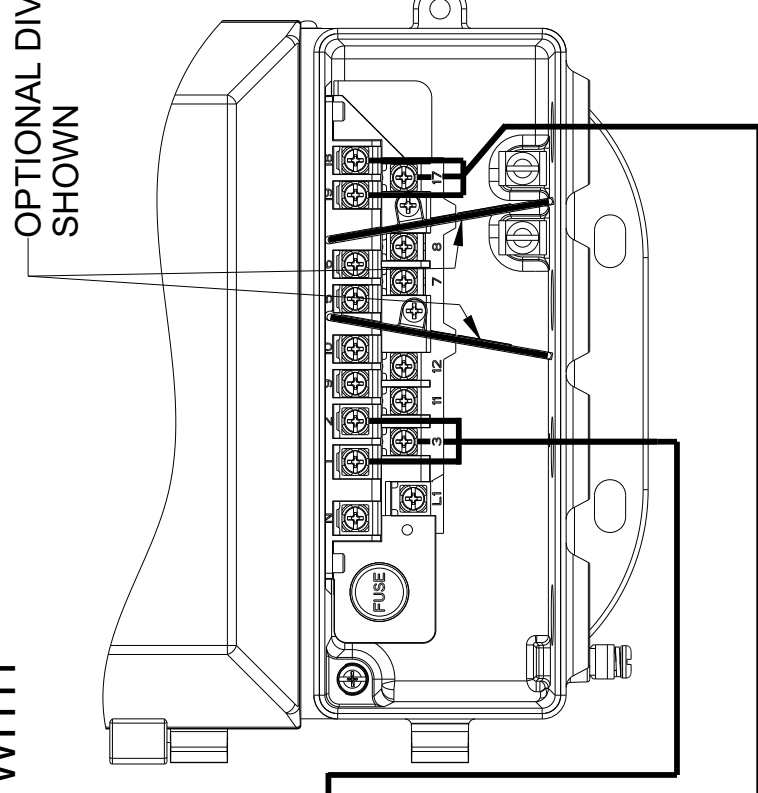

8712EM TRANSMITTER
(LOWER COVER AND SAFETY COVER ARE NOT SHOWN)

NON-INTRINSICALLY SAFE COIL CIRCUIT
INSTALL USING EPL D_b WIRING
METHODS APPROPRIATE TO THE AREA DEVICE
IS INSTALLED IN

FOR USE WITH NON-FLAMMABLE PROCESS ONLY.
INSTALL ELECTRODE CIRCUIT AS NON-INTRINSICALLY SAFE
USING EPL D_b WIRING METHODS APPROPRIATE
TO THE AREA DEVICE IS INSTALLED IN.

TERMINAL	LABEL
NON-INTRINSICALLY SAFE ELECTRODE CIRCUIT	
19	ELECTRODE +
18	ELECTRODE -
17	ELECTRODE REFERENCE (SE)
NON-INTRINSICALLY SAFE COIL CIRCUIT	
1	COIL +
2	COIL -
3	COIL SHIELD (SC)

CONFIDENTIAL AND PROPRIETARY
INFORMATION IS CONTAINED HEREIN
AND MUST BE HANDLED ACCORDINGLY.

UNLESS OTHERWISE SPECIFIED
DIMENSIONS IN INCHES (mm). REMOVE
ALL BURRS AND SHARP EDGES.

-DEC TOLERANCES-
X ± .1 [2.5]
.XX ± .02 [0.5]
.XXX ± .010 [0.25]
FRACTIONS ± 1/32 ANGLES ± 2°

SURFACE FINISH UNLESS
OTHERWISE SPECIFIED

125° 3RD ANGLE

SIZE C

SCALE -

REV AD



ROSEMOUNT

TITLE
INSTALLATION DRAWING
CSA CANADIAN AND USA ZONE

DR. N. BOND 2/18/14 DRAWING NO. 08732-2066
APPD. E. MESSENGER 6/13/14

DO NOT SCALE PRINT CAD MAINTAINED. (PROJ) PRODUCT CODE DOC TYPE SHEET 12 OF 15

08732-2066
DRAWING NO.

GAS AND DUST ENVIRONMENT - OUTPUT WIRING

HAZARDOUS (CLASSIFIED) LOCATION CONFIGURATION
INTRINSICALLY SAFE OUTPUTS

WARNING: SUBSTITUTION OF COMPONENTS MAY IMPAIR INTRINSIC SAFETY

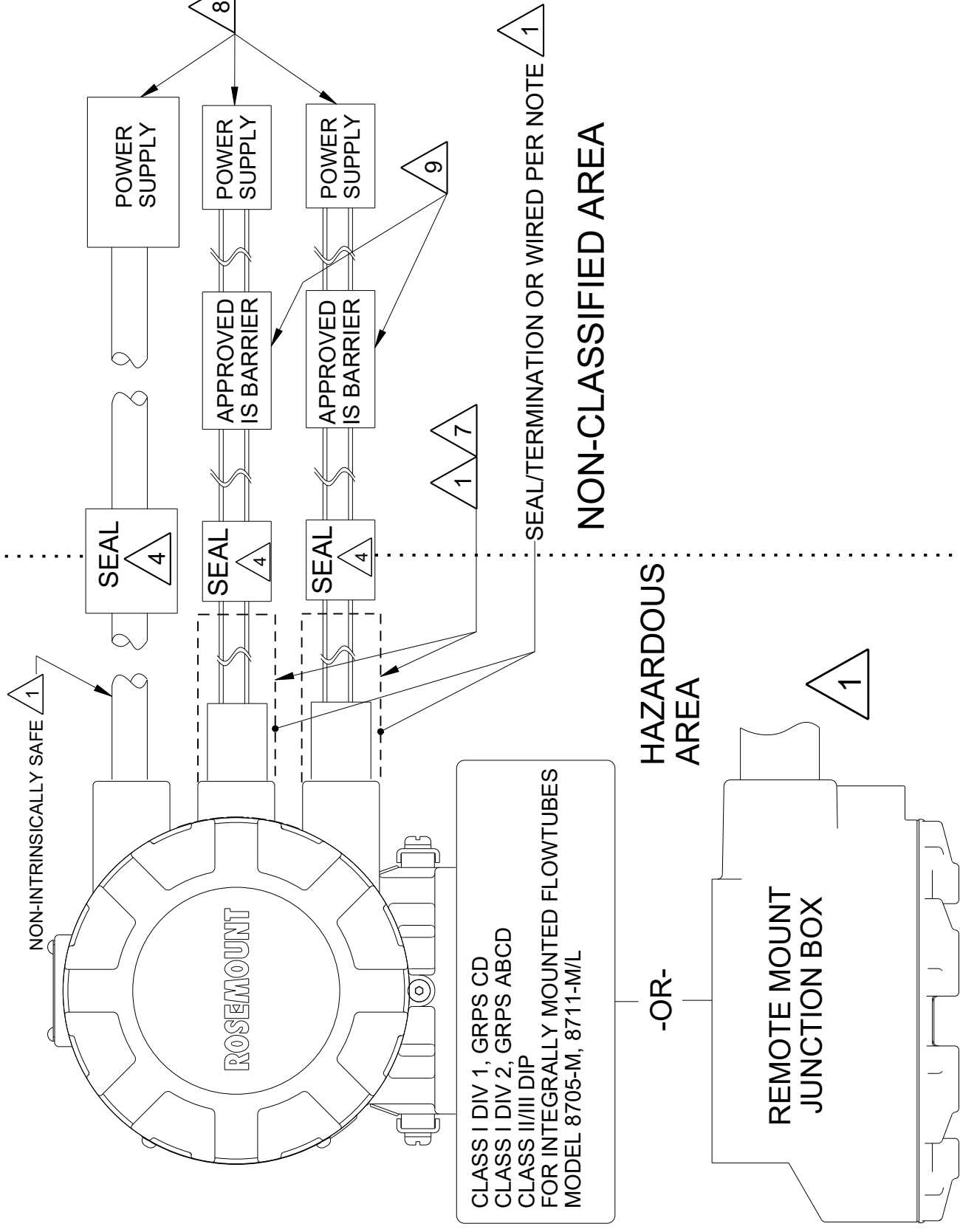

HAZARDOUS LOCATION CONFIGURATION
INTRINSICALLY SAFE OUTPUTS

WARNING: SUBSTITUTION OF COMPONENTS MAY IMPAIR
INTRINSIC SAFETY

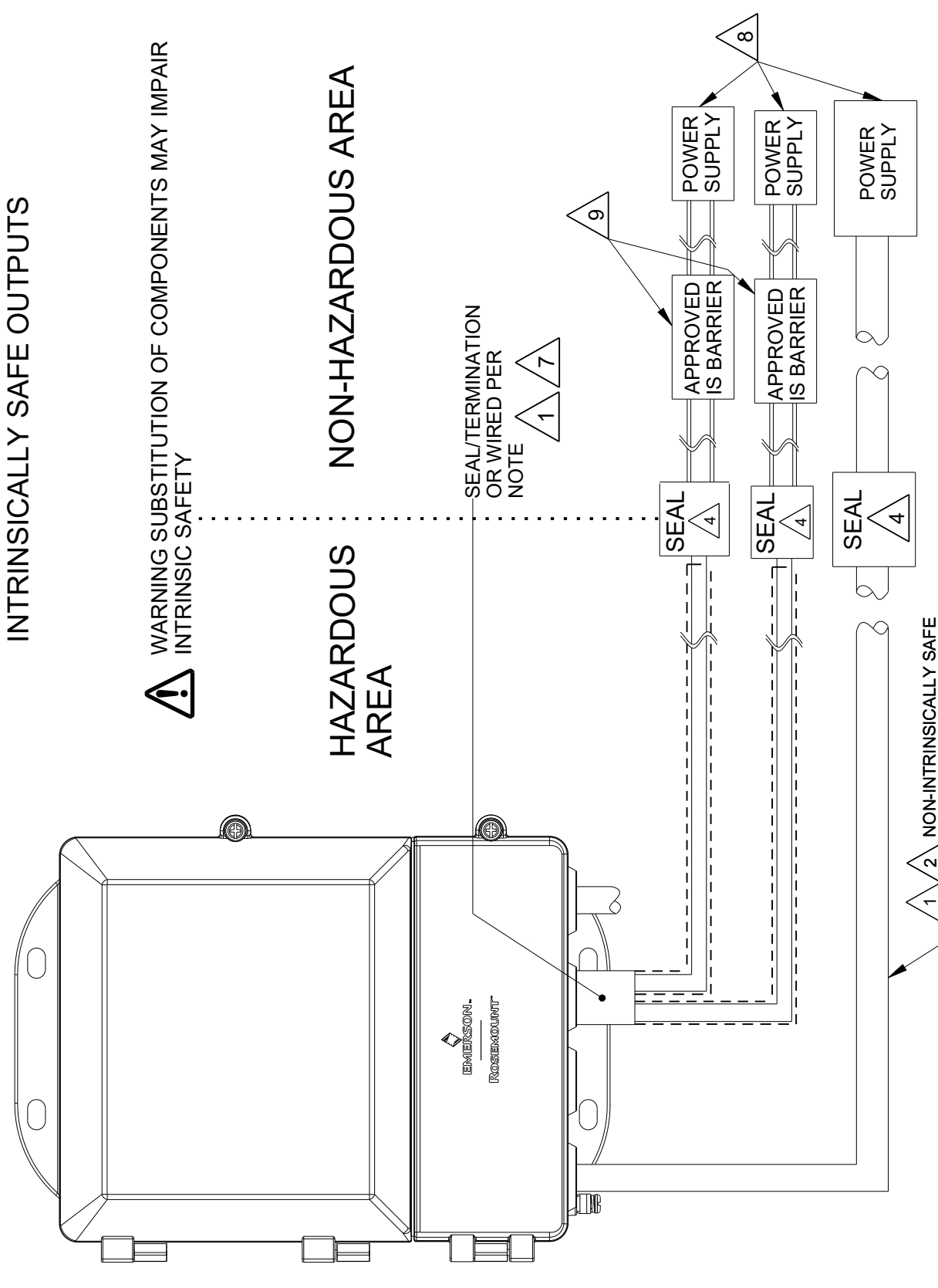

8732EMxxAx K6

B NC

F

M

P

SAFETY APPROVALS

A	NON-INTRINSICALLY SAFE 4-20 mA
B	INTRINSICALLY SAFE 4-20mA AND PULSE OUTPUT
F	INTRINSICALLY SAFE FOUNDATION FIELDBUS AND PULSE OUTPUT
M	NON-INTRINSICALLY SAFE MODBUS AND PULSE OUTPUT
P	INTRINSICALLY SAFE PROFIBUS AND PULSE OUTPUT

TRANSMITTER CLASS

8712EMxxAx NC

B

F

M

P

SAFETY APPROVALS

A	NON-INTRINSICALLY SAFE 4-20 mA
B	INTRINSICALLY SAFE 4-20mA AND PULSE OUTPUT
F	INTRINSICALLY SAFE FOUNDATION FIELDBUS AND PULSE OUTPUT
M	NON-INTRINSICALLY SAFE MODBUS AND PULSE OUTPUT
P	INTRINSICALLY SAFE PROFIBUS AND PULSE OUTPUT

TRANSMITTER CLASS

WHEN CONNECTED IN ACCORDANCE WITH THIS DOCUMENT, THE ROSEMOUNT MODEL 8712EM OR 8732EM WITH INTEGRAL MOUNT FLOWTUBE OR REMOTE-MOUNT JUNCTION BOX IS APPROVED AS:

SAFETY APPROVAL OPTIONS CODE	RATINGS
K6	Ex db eb [ia Ga] FLAMEPROOF/INCREASED SAFETY WITH INTRINSICALLY SAFE ELECTRODE CONNECTIONS
K6 WITH OUTPUT CODE 'B' OR 'F' OR 'P'	Ex db eb [ia Ga] FLAMEPROOF/INCREASED SAFETY WITH INTRINSICALLY SAFE ELECTRODE CONNECTIONS AND INTRINSICALLY SAFE OUTPUTS
NC	Ex ec [ia Ga] TYPE 'e' AND Ex nA [ia Ga] TYPE 'n' WITH INTRINSICALLY SAFE ELECTRODE CONNECTIONS - DC POWER ONLY
NC WITH OUTPUT CODE 'B' OR 'F' OR 'P'	Ex ec [ia Ga] TYPE 'e' AND Ex nA [ia] TYPE 'n' WITH INTRINSICALLY SAFE ELECTRODE CONNECTIONS AND INTRINSICALLY SAFE OUTPUTS - DC POWER ONLY
K6/NC	Ex tb IIIC PROTECTION BY ENCLOSURES
K6/NC WITH OUTPUT CODE 'B' OR 'F' OR 'P'	Ex tb [ia Da] IIIC PROTECTION BY ENCLOSURES WITH INTRINSICALLY SAFE OUTPUTS

08732-2066

DRAWING NO.

CONFIDENTIAL AND PROPRIETARY INFORMATION IS CONTAINED HEREIN AND MUST BE HANDLED ACCORDINGLY.	SURFACE FINISH UNLESS OTHERWISE SPECIFIED	125	3RD ANGLE	✓	SCALE	-	REV	AD
UNLESS OTHERWISE SPECIFIED DIMENSIONS IN INCHES (mm). REMOVE ALL BURRS AND SHARP EDGES.	ROSEMOUNT							
-DEC TOLERANCES-	EMERSON							
X ± .1 [2.5]	TITLE							
.XX ± .02 [0.5]	INSTALLATION DRAWING							
.XXX ± .010 [0.25]	ROSEMOUNT							
FRACTIONS ± 1/32	CSA CANADIAN AND USA ZONE							
ANGLES ± 2'	DR. N. BOND 2/18/14 DRAWING NO. 08732-2066							
	APPD. E. MESSENGER 6/13/14							
	DO NOT SCALE PRINT CAD MAINTAINED (PROJ) PRODUCT CODE SHEET 13 OF 15							

GAS AND DUST ENVIRONMENT - INTRINSICALLY SAFE ENTITY CONCEPTS

8732EM ENTITY CONCEPT FOR INTRINSICALLY SAFE OUTPUTS

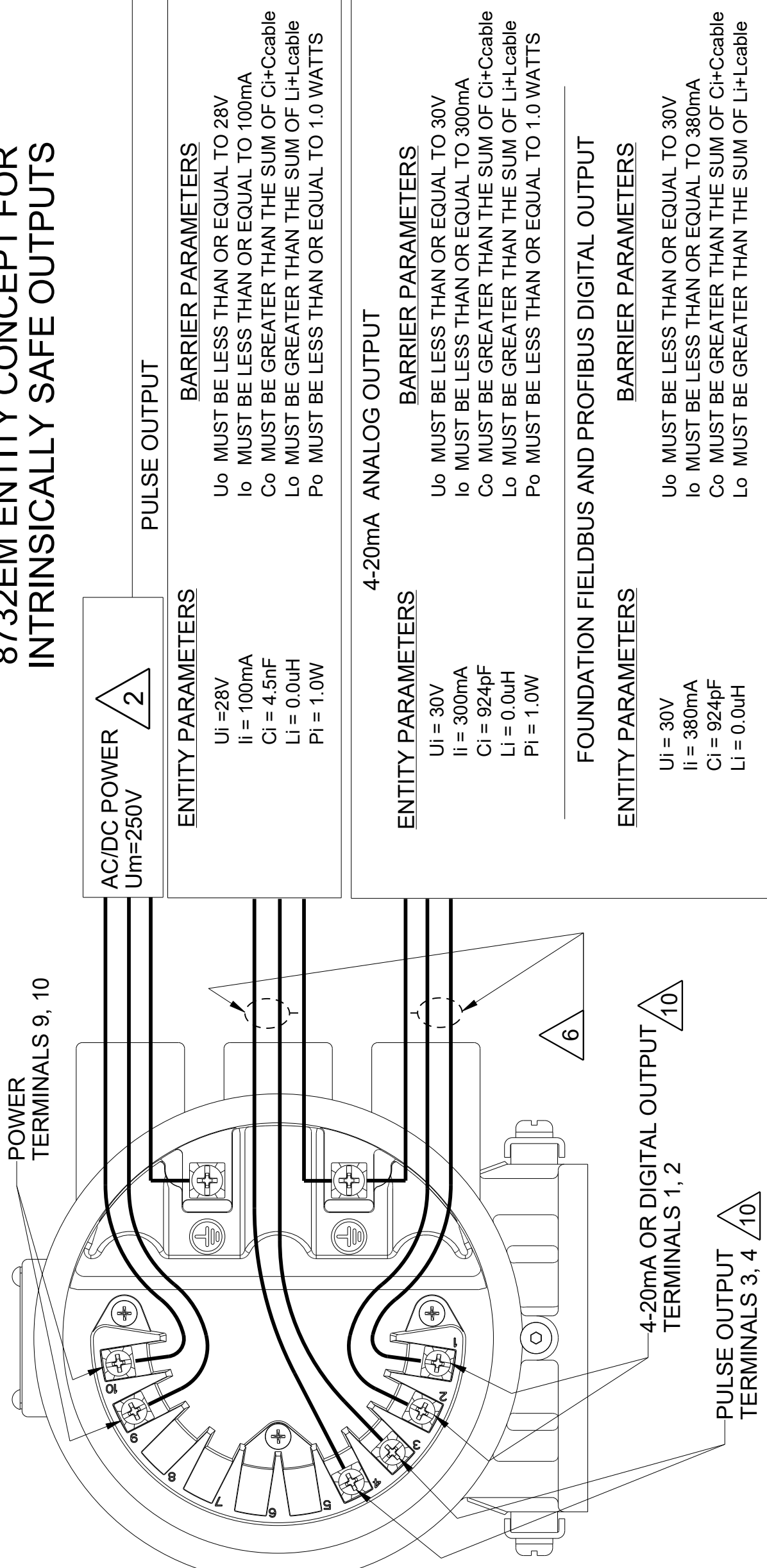

DEFINITIONS:

- U_i = MAXIMUM INPUT VOLTAGE
- I_i = MAXIMUM INPUT CURRENT
- C_i = MAXIMUM INTERNAL CAPACITANCE
- L_i = MAXIMUM INTERNAL INDUCTANCE
- P_i = MAXIMUM INPUT POWER
- U_o = OPEN CIRCUIT VOLTAGE OF THE BARRIER
- I_o = SHORT CIRCUIT CURRENT OF THE BARRIER
- C_o = MAXIMUM ALLOWED CAPACITANCE
- L_o = MAXIMUM ALLOWED INDUCTANCE
- P_o = MAXIMUM OUTPUT POWER

THE ENTITY CONCEPT ALLOWS INTERCONNECTION OF ASSOCIATED APPARATUS AND INTRINSICALLY SAFE APPARATUS WHEN THE FOLLOWING IS TRUE:

$$U_o \leq U_i, I_o \leq I_i, P_o \leq P_i, C_o \geq C_i + C_{cable}, L_o \geq L_i + L_{cable}$$

ASSOCIATED APPARATUS MUST BE CERTIFIED, AND FOLLOW MANUFACTURER'S INSTALLATION DRAWINGS. TO MAINTAIN THE INTRINSICALLY SAFE OUTPUT THE TRANSMITTER MUST BE CONNECTED TO A CERTIFIED BARRIER THAT SATISFIES THE FOLLOWING CONDITIONS.

APPROVED WITH INTRINSICALLY SAFE CONNECTIONS FOR CLASS I, DIVISION 1, GROUPS ABCD; CLASS II AND III, DIVISION 1, GROUPS EFG.

8712EM ENTITY CONCEPT FOR INTRINSICALLY SAFE OUTPUTS

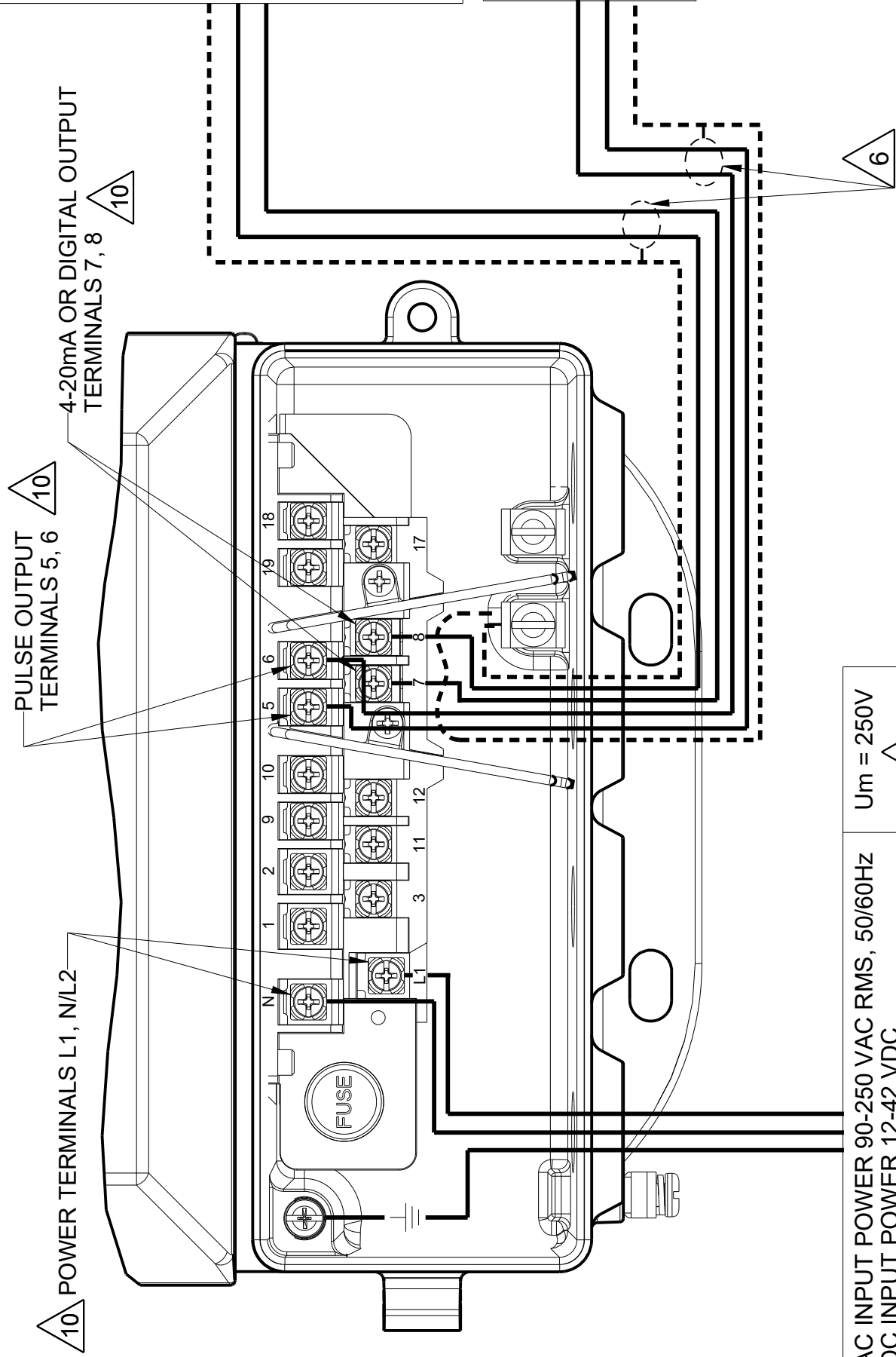

4-20mA ANALOG OUTPUT

ENTITY PARAMETERS

- U_i = 30V
- I_i = 300mA
- C_i = 924pF
- L_i = 0.0uH
- P_i = 1.0W

BARRIER PARAMETERS

- U_o MUST BE LESS THAN OR EQUAL TO 30V
- I_o MUST BE LESS THAN OR EQUAL TO 300mA
- C_o MUST BE GREATER THAN THE SUM OF C_i+C_{cable}
- L_o MUST BE GREATER THAN THE SUM OF L_i+L_{cable}
- P_o MUST BE LESS THAN OR EQUAL TO 1.0 WATTS

FOUNDATION FIELDBUS AND PROFIBUS DIGITAL OUTPUT

ENTITY PARAMETERS

- U_i = 30V
- I_i = 380mA
- C_i = 924pF
- L_i = 0.0uH

- U_o MUST BE LESS THAN OR EQUAL TO 30V
- I_o MUST BE LESS THAN OR EQUAL TO 380mA
- C_o MUST BE GREATER THAN THE SUM OF C_i+C_{cable}
- L_o MUST BE GREATER THAN THE SUM OF L_i+L_{cable}

PULSE OUTPUT

ENTITY PARAMETERS

- U_i = 28V
- I_i = 100mA
- C_i = 4.5nF
- L_i = 0.0uH
- P_i = 1.0W

BARRIER PARAMETERS

- U_o MUST BE LESS THAN OR EQUAL TO 28V
- I_o MUST BE LESS THAN OR EQUAL TO 100mA
- C_o MUST BE GREATER THAN THE SUM OF C_i+C_{cable}
- L_o MUST BE GREATER THAN THE SUM OF L_i+L_{cable}
- P_o MUST BE LESS THAN OR EQUAL TO 1.0 WATTS

AC INPUT POWER 90-250 VAC RMS, 50/60Hz
 DC INPUT POWER 12-42 VDC
 DC LOW POWER 12-30 VDC

U_m = 250V

CONFIDENTIAL AND PROPRIETARY INFORMATION IS CONTAINED HEREIN AND MUST BE HANDLED ACCORDINGLY.	SURFACE FINISH UNLESS OTHERWISE SPECIFIED	125	3RD ANGLE	SIZE	SCALE	REV
UNLESS OTHERWISE SPECIFIED DIMENSIONS IN INCHES (mm). REMOVE ALL BURRS AND SHARP EDGES.				C	-	AD
-DEC TOLERANCES- X ± .1 [2.5] .XX ± .02 [0.5] .XXX ± .010 [0.25] FRACTIONS ± 1/32 ANGLES ± 2'	EMERSON ROSEMOUNT					
TITLE INSTALLATION DRAWING CSA CANADIAN AND USA ZONE						
DR. N. BOND 2/18/14 DRAWING NO. 08732-2066						
APPD. E. MESSENGER 6/13/14						
DO NOT SCALE PRINT CAD MAINTAINED (PROJ) PRODUCT CODE						
SHEET 14 OF 15						

DRAWING NO. 08732-2066

GAS AND DUST ENVIRONMENT - FISCO CONCEPT

FISCO CONCEPT

THE FISCO CONCEPT ALLOWS INTERCONNECTION OF INTRINSICALLY SAFE APPARATUS TO ASSOCIATED APPARATUS NOT SPECIALLY EXAMINED IN SUCH COMBINATION. THE CRITERIA FOR INTERCONNECTION IS THAT THE VOLTAGE (V_{max}), THE CURRENT (I_{max}), AND THE POWER (P_{max}) WHICH AN INTRINSICALLY SAFE APPARATUS CAN RECEIVE AND REMAIN INTRINSICALLY SAFE CONSIDERING FAULTS, MUST BE EQUAL OR GREATER THAN VOLTAGE (V_{oc}), AND CURRENT (I_{sc}) WHICH CAN BE DELIVERED BY THE ASSOCIATED APPARATUS, CONSIDERING FAULTS AND APPLICABLE FACTORS. IN ADDITION, THE MAXIMUM UNPROTECTED CAPACITANCE (C_i) AND THE INDUCTANCE (L_i) OF EACH APPARATUS (OTHER THAN THE TERMINATION) CONNECTED TO THE FIELDBUS MUST BE LESS THAN OR EQUAL TO 5 nF AND 10 μ H RESPECTIVELY.

IN EACH SEGMENT ONLY ONE ACTIVE DEVICE, NORMALLY THE ASSOCIATED APPARATUS, IS ALLOWED TO PROVIDE THE NECESSARY ENERGY FOR THE FIELDBUS SYSTEM. THE VOLTAGE (V_{oc}) OF THE ASSOCIATED APPARATUS IS LIMITED TO A RANGE OF 14 TO 17.5 VDC. ALL OTHER EQUIPMENT CONNECTED TO THE BUS CABLE HAS TO BE PASSIVE, MEANING THAT THEY ARE NOT ALLOWED TO PROVIDE ENERGY TO THE SYSTEM, EXCEPT A LEAKAGE CURRENT OF 50 μ A FOR EACH CONNECTED DEVICE. SEPARATELY POWERED EQUIPMENT NEEDS GALVANIC ISOLATION TO ASSURE THAT THE INTRINSICALLY SAFE FIELDBUS CIRCUIT REMAINS PASSIVE.

THE CABLE USED TO INTERCONNECT DEVICES NEEDS TO HAVE THE PARAMETERS IN THE FOLLOWING RANGE:

Loop Resistance R_c :	15.....150 Ohm/km
Inductance per unit length L_c :	0.4.....1 mH/km
Capacitance per unit length C_c :	45.....200 nF
Length of trunk cable:	less than or equal to 1000m
Length of spur cable:	less than or equal to 60m

AT EACH END OF THE TRUNK CABLE AN APPROVED INFALLIBLE LINE TERMINATION WITH THE FOLLOWING PARAMETERS IS SUITABLE.

$$R = 90 \dots 102 \text{ Ohm} \quad C = 0 \dots 2.2 \text{ } \mu\text{F}$$

ONE OF THE ALLOWED TERMINATIONS MIGHT ALREADY BE INTEGRATED IN THE ASSOCIATED APPARATUS. THE NUMBER OF PASSIVE APPARATUS CONNECTED TO THE BUS SEGMENT IS NOT LIMITED TO I.S. REASONS. IF THE ABOVE RULES ARE RESPECTED, UP TO A TOTAL LENGTH OF 1000 m (SUM OF TRUNK AND ALL SPUR CABLES) OF CABLE IS PERMITTED. THE INDUCTANCE AND THE CAPACITANCE OF THE CABLE WILL NOT IMPAIR THE INTRINSIC SAFETY OF THE INSTALLATION.

ENTITY PARAMETER

$U_i = 30V$
 $I_i = 380 \text{ mA}$
 $C_i = 924 \text{ pF}$
 $L_i = 0.0 \text{ } \mu\text{H}$
 $P_i = 5.32 \text{ W}$

BARRIER PARAMETERS

U_o MUST BE LESS THAN OR EQUAL TO 30V
 I_o MUST BE LESS THAN OR EQUAL TO 380 mA
 C_o MUST BE GREATER THAN THE SUM OF $C_i + C_{cable}$
 L_o MUST BE GREATER THAN THE SUM OF $L_i + L_{cable}$

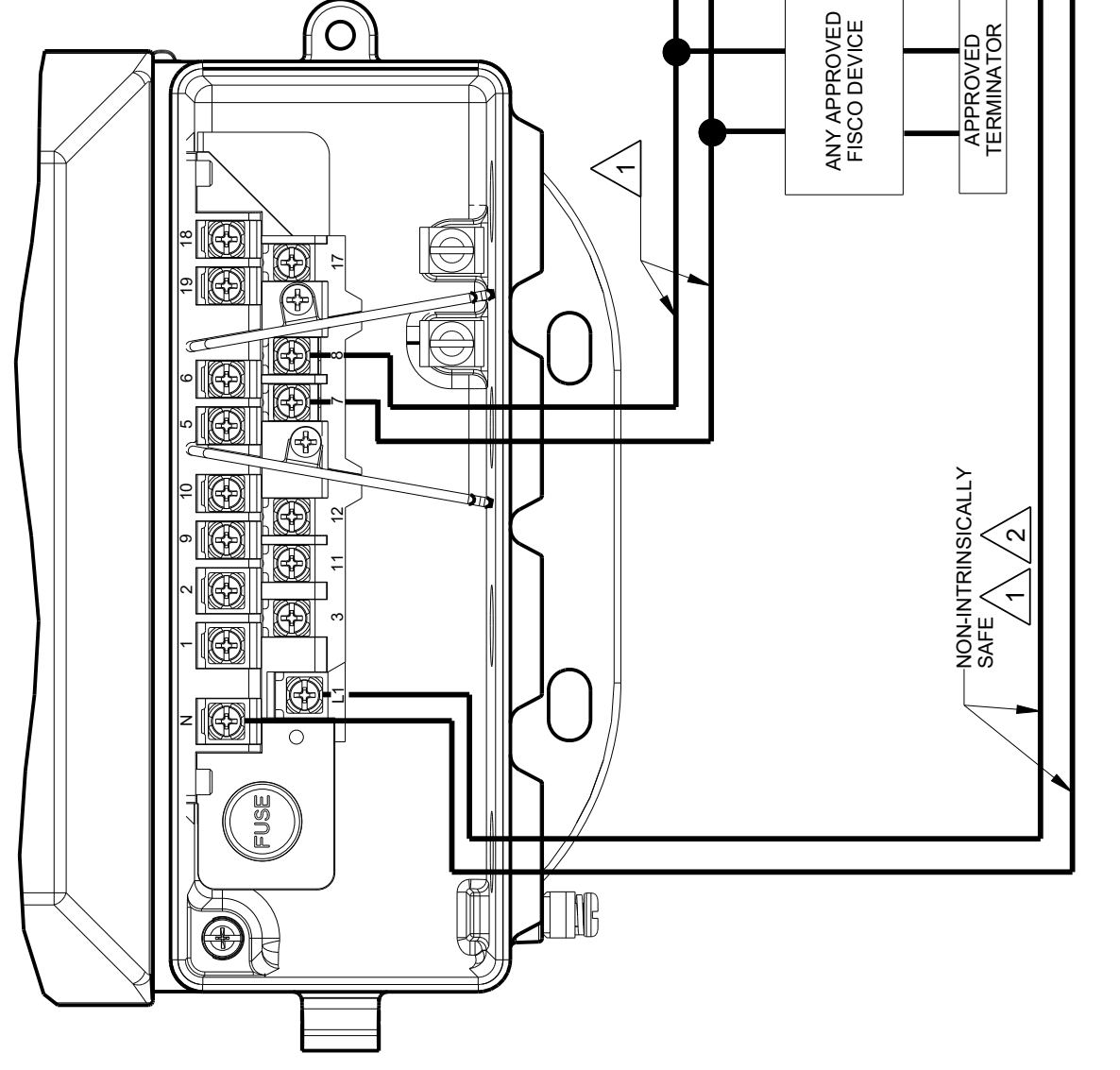
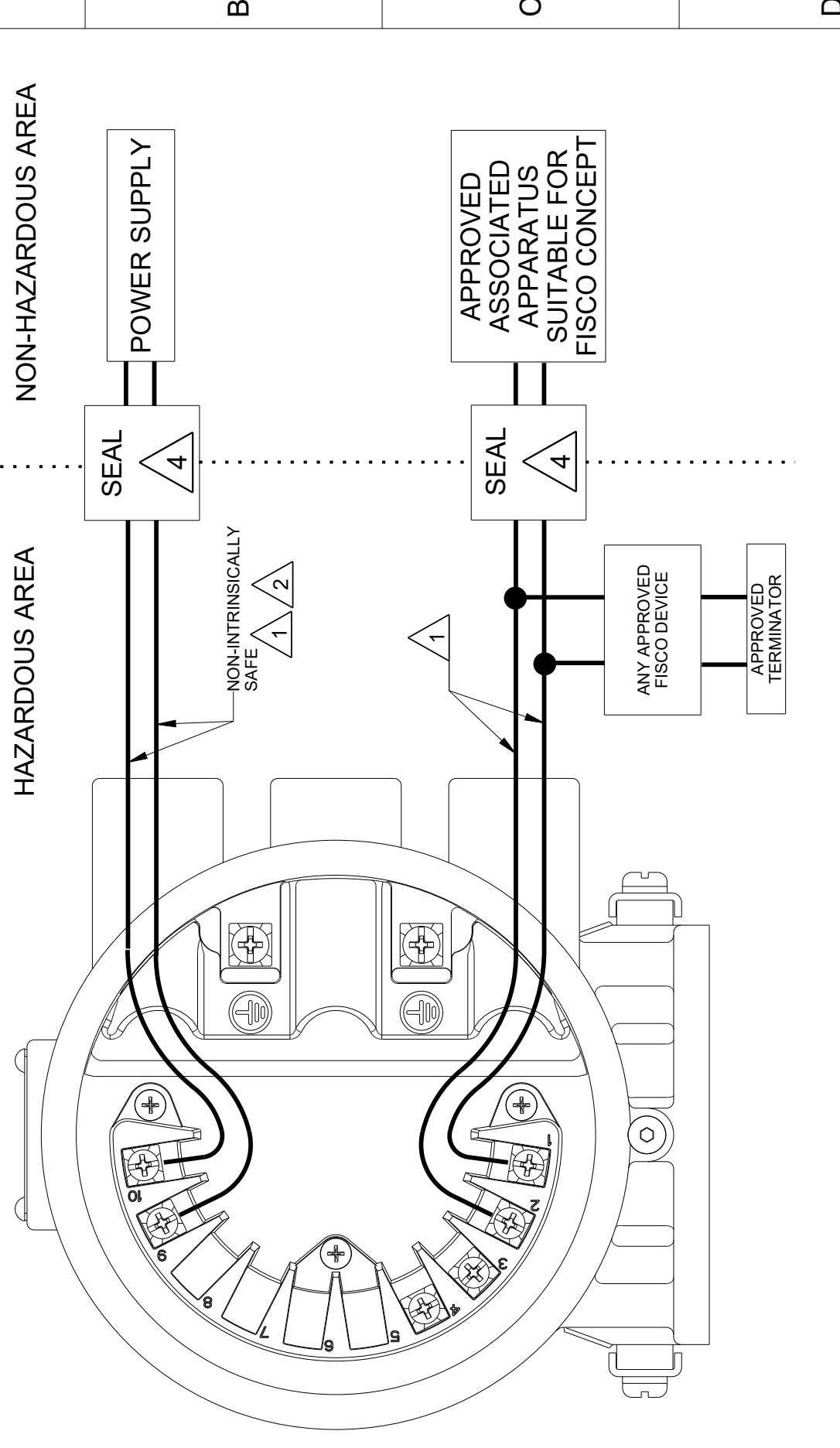

CONFIDENTIAL AND PROPRIETARY INFORMATION IS CONTAINED HEREIN AND MUST BE HANDLED ACCORDINGLY.	SURFACE FINISH UNLESS OTHERWISE SPECIFIED	125	3RD ANGLE	SIZE	C	SCALE	-	REV	AD
	DRAWING NO. 08732-2066								
EMERSON									
TITLE ROSEMOUNT									
UNLESS OTHERWISE SPECIFIED DIMENSIONS IN INCHES (mm). REMOVE ALL BURRS AND SHARP EDGES.									
-DEC TOLERANCES-									
X ± .1 [2.5]									
.XX ± .02 [0.5]									
.XXX ± .010 [0.25]									
FRACTIONS ± 1/32 ANGLES ± 2'									
DO NOT SCALE PRINT CAD MAINTAINED (PROJ) PRODUCT CODE									
DRAWING NO. 08732-2066									
DR. N. BOND 2/18/14 DRAWING NO. 08732-2066									
APPR. MESSENGER 6/13/14									
DOC TYPE SHEET 15 OF 15									



For more information: www.emerson.com

©2021 Emerson. All rights reserved.
Emerson Terms and Conditions of Sale are available upon request. The Emerson logo is a trademark and service mark of Emerson Electric Co. Rosemount is a mark of one of the Emerson family of companies. All other marks are the property of their respective owners.