



**Achieve Cutting-Edge Aesthetics  
and Design Flexibility in Automotive  
Lamp Assemblies**

**Branson™ Plastics Welding**  
Solutions that create trend-setting automotive lighting



**You need to produce larger, multidimensional and increasingly complex lighting assemblies that combine beauty, style and functionality.**



Auto lighting components are becoming increasingly complex like this tail light, which can be up to a meter long and incorporate delicate sensors.

Your success depends on helping today's automakers bring sleek, elegant and dramatic new designs to market. These cars must capture the prospective driver's attention and satisfy their craving for innovation and cutting-edge aesthetics. Lighting is a key to meeting these objectives in today's automobiles, from stylish one-piece center tail lamps with complex multidimensional contours, to subtle interior mood lighting that makes the cockpit a more welcoming, comfortable space.

These assemblies pose stiff challenges for manufacturers like you. Fortunately, Branson joining solutions from Emerson meet these challenges with technology that is as advanced as the applications in which they are used.



## Trends influencing automotive lighting design and manufacturing

An increased focus on safety is leading to a rise in new automotive lighting solutions, which can help reduce the number of accidents. For example, adaptive lighting systems can adjust to changing visibility conditions, while other innovations — including cameras, radar and sensors — can be combined with lighting to help spot danger and further reduce the likelihood of crashes.

To learn more, visit [www.Emerson.com/Branson](http://www.Emerson.com/Branson)

Customer demand for style and sophistication is driving the need for newer, cleaner and more versatile joining technologies.

- **Aesthetics...** There is increasing demand for the clean, particulate-free welds made possible by Branson Clean Joining Technologies.



- **Design Flexibility...** Larger/longer lights, more complex geometry and seamless curves all mean that designs cannot be constrained by the straight, flat planes required by conventional joining technologies.



- **Electronic Complexity...** Embedded electronics, organic LEDs, delicate sensors, cameras, scanners and other sensitive components require gentler — but no less robust — assembly methods.



# Increasingly complex automotive lighting applications made possible by advanced plastics welding processes

Once purely functional, automotive lighting applications are now elements of style and design, requiring welders that allow for delicate sensors, larger components with complex geometries, and flash-free welds — like Branson Clean Joining Technologies.



## Exterior Front Side

- Front light
- Fog light front
- Daytime running light
- Lighted emblem



## Exterior Rear Side

- Rear fender light
- Rear trunk light
- Large center trunk light
- Center high mount stop light
- Rear fog light
- Inlays



## Exterior Left/Right Side

- Mirror turn signal light
- Side wall indicator
- Door logo light
- Door handle
- Puddle light



## Interior

- Ambient floor light
- Ambient door light
- Ambient instrument panel light
- Ambient seat light
- Signal light
- Logo projector



## Driver Assistant Systems

- Lane change assistant
- Back-up light
- Cameras
- Radar/lidar



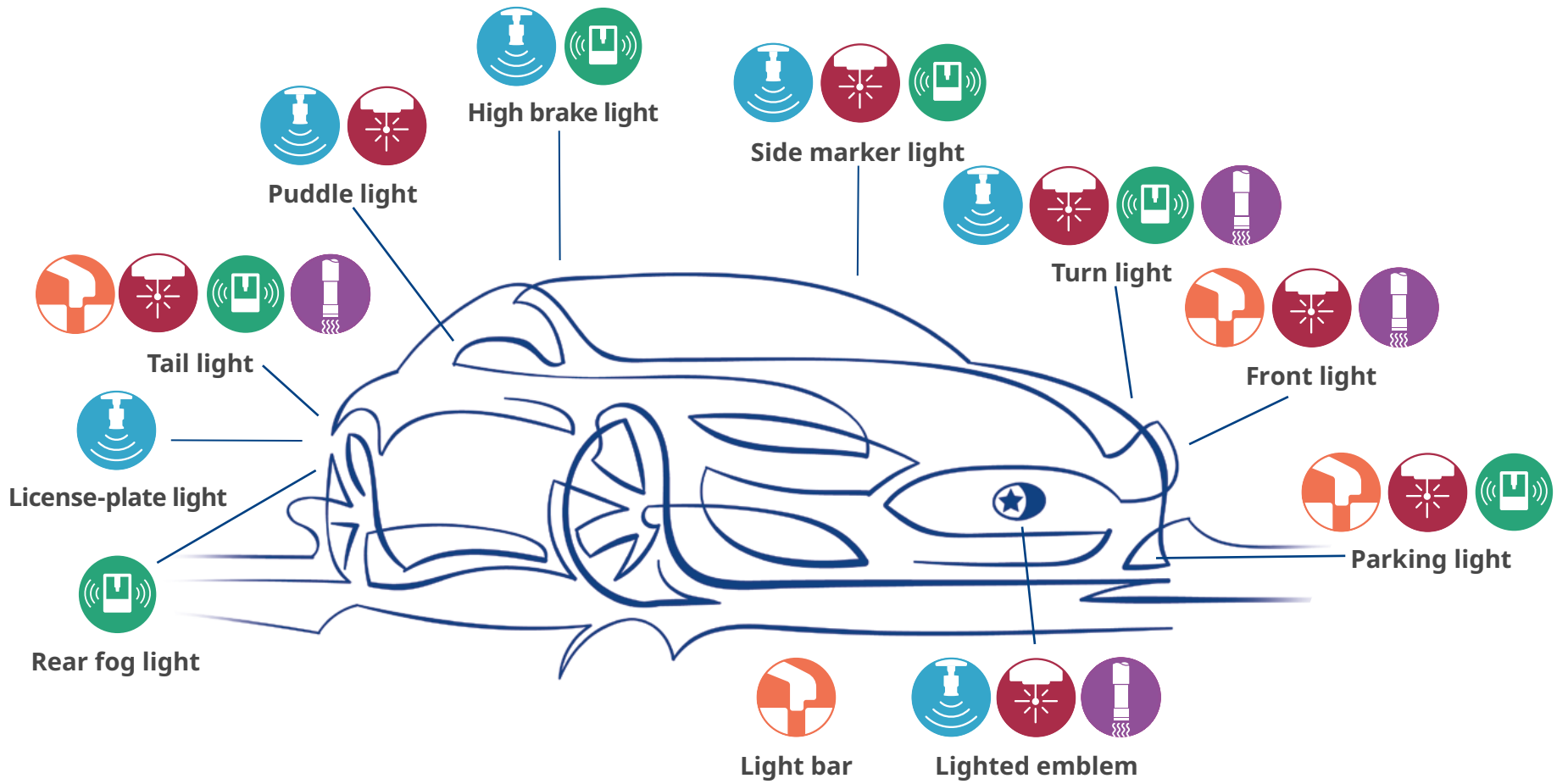

Icon Key

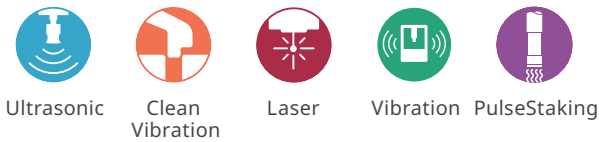

# Emerson delivers solutions in the dynamic automotive marketplace

By fostering a joint innovation culture with lamp manufacturers and automakers, Emerson and its Branson brand help you continually challenge the limits of your creativity and develop extraordinary new product designs.



## Emerson engineers are unrivaled in their experience and expertise

- Process experts solve problems and improve processes
- We listen to our customers to deliver customized engineered solutions
- Emerson's process-neutral approach helps you discover the right solution



## Complete equipment portfolio offers the best solutions in the industry

- Clean vibration and laser welding
- Effective and economic ultrasonic welding
- Heat staking is ideal for joining dissimilar materials



## Superior global support

- Local representatives and technicians understand your needs
- Application support around the world
- Aftermarket services ensure maximum performance and reliability



## Clean welding creates particulate-free, high-strength bonding on aesthetically complex assemblies

When it comes to meeting the challenges posed by cutting-edge automotive lighting, two technologies — Clean Vibration Technology and Simultaneous Through-Transmission Infrared (STTIr®) laser welding — stand out for their ability to create beautiful welds, free of “angel hair,” particulates and flash.

In addition, you get:

- High-strength bonds
- Hermetic seal prevents air and water intrusion
- Delicate electronics less likely to be damaged during assembly
- Ability to join more sensitive, challenging polymers
- Design freedom for complex shapes and contours

Branson contoured laser welding is especially useful for fast and accurate assembly of the new sophisticated designs of today's center tail lamp assemblies.

# Laser welding delivers speed, strength and versatility

Laser welding is remarkably versatile, producing a clean homogeneous weld, with equally distributed strength, reduced part stress and longer service life.

In operation, the two components are held together under pressure as the laser light passes through one part (the transmissive surface) and strikes the other absorptive surface, where laser energy is converted to heat, creating the weld. Recent additive and coating developments have even made clear-clear applications possible.

Simultaneous Through Transmission Infrared®, or STTIr is especially beneficial in automotive lighting applications. A custom-tailored Waveguide directs light to all points on the weld line simultaneously, even in different, three-dimensional spatial planes.

- Fast process
- High throughput for mass production.
- Suits parts of all sizes, including some more than a meter long
- Welds even some otherwise incompatible polymers

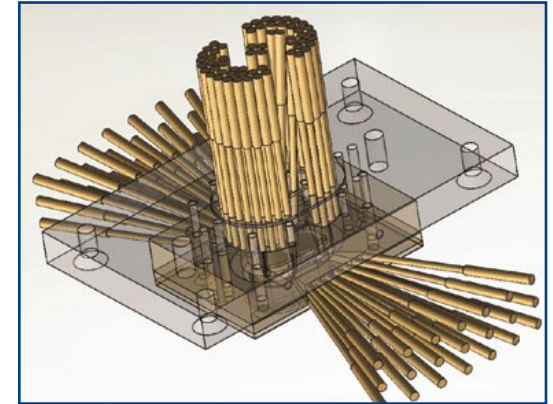

## How Laser Works

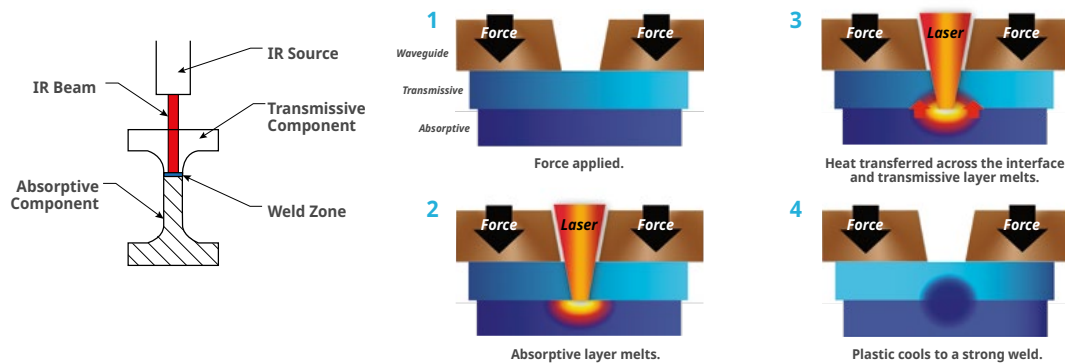



# Branson laser welding product portfolio for automotive lighting applications

The Branson GLX Laser Series sets new standards for welding precision, performance and quality to support your automotive lighting projects.

- Five models ranging in size from the smallest GLX-1 to the largest and newest GLX-4
- Highly repeatable and stable, with assembly yield rates of greater than 99.5%
- Typical weld depths are 0.2-0.8 mm, but depths of 1.0 mm or greater are easily achievable



## Laser Welding



**GLX - 1.5**



**GLX - 2**



**GLX - 3**



**GLX - 4**

	<b>GLX - 1.5</b>	<b>GLX - 2</b>	<b>GLX - 3</b>	<b>GLX - 4</b>
<b>Laser Technology</b>	STTlr®	STTlr®	STTlr®	STTlr®
<b>Welder Type</b>	Small	Single Cavity	Double Cavity	Large
<b>Clamp Force Range</b>	1-10 kN	1-15 kN	1-25 kN	1.5-25 kN
<b>Upper Tooling Size (mm)</b>	890 x 680	1080 x 620	1370 x 650	1778 x 650
<b>Table Size (mm)</b>	800 x 500	1070 x 600	1360 x 600	1770 x 600

Small Part

Very Large Part

## “Clean” is the important new watchword in vibration welding

Clean Vibration Technology (CVT) offers manufacturers significant advantages in demanding automotive lighting applications.

- Unlike conventional vibration welding, in which the heat needed to create the weld is developed by aggressive friction between the two parts to be welded, CVT is a two-step process
- A metal foil infrared emitter preheats the joint surfaces before the two parts are brought together under pressure and a gentle vibration to complete the process
- Resulting weld is free of particulates, and with some materials the weld joint has lower stress, equating to higher strength

### How CVT Works



In clean vibration welding, one of the surfaces to be joined is preheated (left) to minimize the amount of vibration needed to complete the weld (right). Welds are cleaner, and the potential for damage to sensitive electronics is minimized.

# Comprehensive clean vibration welding portfolio for small to very large parts

GVX welders have been proven in lighting applications requiring superior aesthetics and rugged performance.

- Emitter specifications matched to each material's absorption characteristic for increased energy efficiency
- Can be used to weld large complex shapes



Clean Vibration

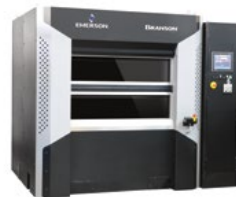

GVX-2HR



GVX-3R/HR



GVX-4R/HR

	GVX-2HR	GVX-3R/HR	GVX-4R/HR
<b>Application</b>	Double Cavity	Double Cavity	Large Part
<b>Clamp Force Range</b>	1-25kN	1-25kN	1-25kN
<b>Table Size (mm)</b>	1070 x 600	1360 x 600	1770 x 600

Small Part

Very Large Part

## PulseStaking: a low-stress, uniform approach to retaining sub-assemblies

Branson GPX PulseStaking technology allows for the joining of components to molded plastic structures. Able to join sensitive parts without damage, Branson heatstaking is an ideal solution for automotive lighting.

- Unlike other staking technologies, PulseStaking does not utilize vibratory energy, which can damage studs, induce stress in the formed stud, and generate loose particulate.
- Instantaneous heating and cooling reduces the potential for the stringing or sticking of plastic typical of conventional heated tooling.
- Tool design flexibility overcomes difficult part geometry and limited stake-access challenges.

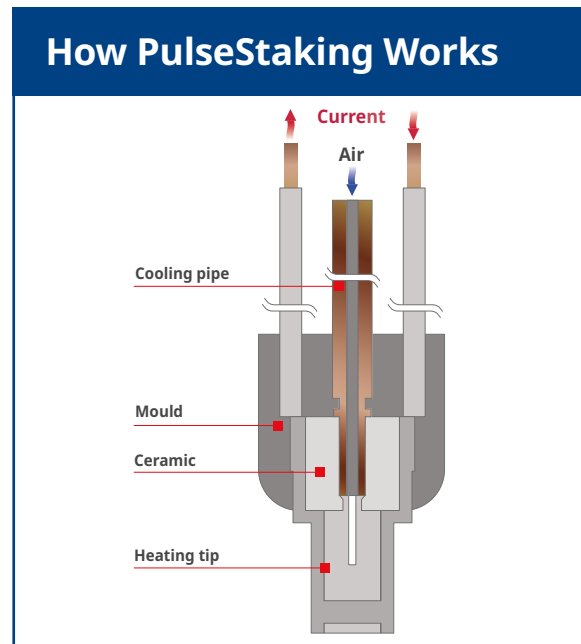

Electric current flows through the PulseStaking tip, creating electrical resistance that instantaneously produces controlled heat to melt the plastic, which is then cooled to hold components firmly in place.

# Branson GPX platform includes products for any staking application

From hand-held units for prototyping, to benchtop models for small-scale production and machinery capability evaluation, to full-size production machines, the Branson GPX PulseStaking product line offers you the ideal solution.



**PulseStaking**



**Handheld GPX**



**GPX-100**



**GPX-150**



**GPX-200**

	Handheld GPX	GPX-100	GPX-150	GPX-200
<b>Overall Dimensions (mm)</b>	155 W x 285 H x 465 D	1420 W x 2300 H x 1150 D	1920 W x 2300 H x 1150 D	2230 W x 2300 H x 1150 D
<b>Central Drive Stroke (mm)</b>	N/A	550	550	550
<b>Central Drive Speed (mm/s)</b>	N/A	550	550	550
<b>Maximum Number of Welding Tips</b>	2 pcs	24 pcs	48 pcs	60 pcs



# Trust Branson technologies from Emerson to support your automotive lighting project from beginning to end

Emerson understands that constant innovation is your only route to success in the automotive lighting market. Our “process neutral” approach to equipment recommendations and a joint innovation culture with lamp manufacturers and automakers, enable Emerson and its Branson brand to help you continually challenge the limits of your creativity and develop extraordinary new product designs. Emerson supports you at every stage:

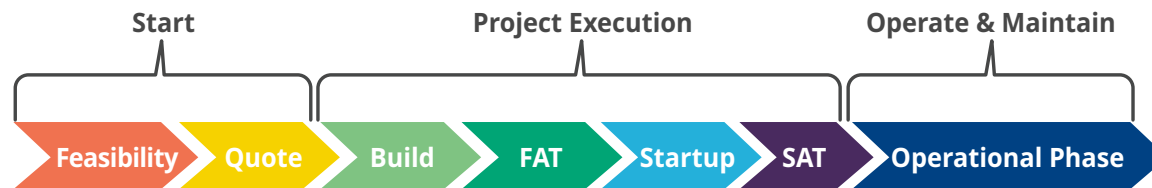

## Application Development

- Material testing
- Part & joint design

## Project Engineering & Tooling

- Feasibility & conceptualization
- Horn & fixture design
- Finite element analysis
- Generate tool-manufacturing drawings
- Cost estimating / quotations

## Project Management

- Coordination of engineering & manufacturing
- Resolve part issues
- Customer approval

## Post-installation Customer Support

- Customer visits
- Process troubleshooting
- Tooling checkout
- Training seminars

## Service and support anywhere, anytime

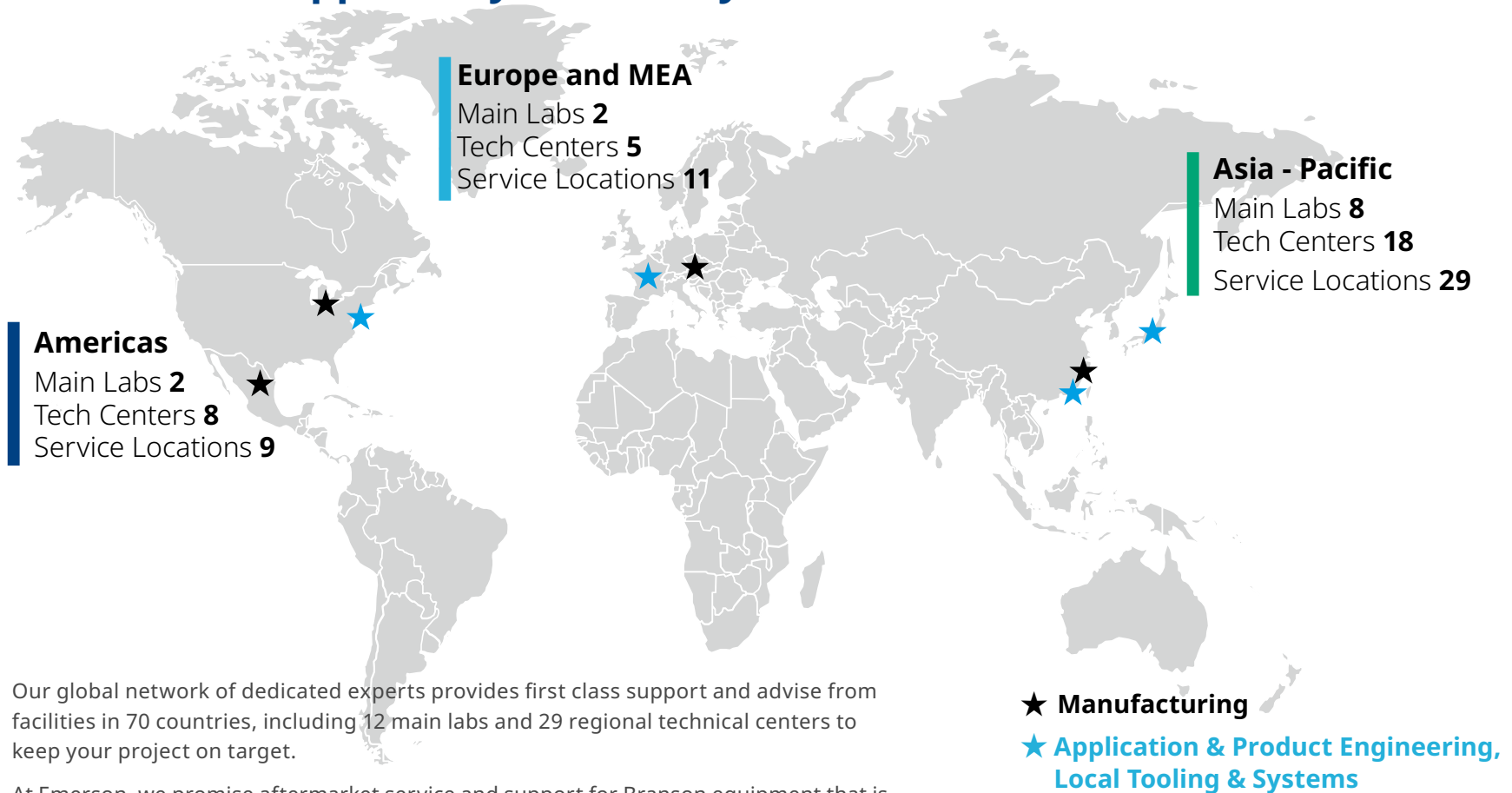

Our global network of dedicated experts provides first class support and advise from facilities in 70 countries, including 12 main labs and 29 regional technical centers to keep your project on target.

At Emerson, we promise aftermarket service and support for Branson equipment that is as globally available, capable, and predictable as your global operations. To support that promise, we offer 35 Branson service centers and service specialists at more than 60 locations worldwide. Our dedicated aftermarket service programs ensure 24/7 technical and onsite support, spare parts, preventive maintenance, calibration, and equipment evaluations to keep production flowing.

## Emerson delivers industry-leading solutions and support for distinctive auto lighting designs







### BRANSON™

Emerson plastic welding technologies help you combine beauty, style and functionality to create today's sophisticated lighting components with unrivaled efficiency and quality.

Visit us: [Emerson.com/Branson](https://www.emerson.com/Branson)

Your local contact: [Emerson.com/contactus](https://www.emerson.com/contactus)

-  [Emerson.com/Branson](https://www.emerson.com/Branson)
-  [Facebook.com/EmersonAutomationSolutions](https://www.facebook.com/EmersonAutomationSolutions)
-  [LinkedIn.com/company/Emerson-Automation-Solutions](https://www.linkedin.com/company/Emerson-Automation-Solutions)
-  [Twitter.com/@Branson\\_Emerson](https://twitter.com/Branson_Emerson)

The Emerson logo is a trademark and service mark of Emerson Electric Co. All other marks are the property of their respective owners. © 2022 Emerson Electric Co. All rights reserved. BR000512ENUS-03\_02-23

