



**Secure and Gentle Gripping to
Optimize Your Production Process**

AVENTICS™ Gripper- And Vacuum Technology

Gripper And Vacuum Components And Systems to
move your products securely and with no damage



AVENTICS Vacuum components keep a safe but gentle grip on everything

07	Product overview	14	Vacuum suction grippers
08	Vacuum generators	16	Mechanical grippers
09	Single-stage/multistage ejectors	18	Vacuum accessories
10	Compact ejectors	22	Expertise, configuration
12	Non-contact grippers	23	Engineering Tools

Effective vacuum technology for various handling tasks

There are many good technical and economic reasons to use vacuum technology. Often, vacuum-based handling is the only reasonable option to automate an application. Both powerful and sensitive, it is ideal for securely and gently moving difficult-to-grip or extremely delicate workpieces. Thanks to an enormous variety of configurable components, vacuum technology can be used in a wide range of applications. It is ideal for realizing custom handling tasks with comparatively little planning and assembly work.

- Versatile, flexible technology for a wide range of industries and applications
- Handling of various objects, materials, and shapes
- Gentle handling without placing a mechanical load on the workpiece

With a broad portfolio of products and deep technical system expertise, we help you find safe, efficient solutions for your special handling tasks.



Our range of grippers and vacuum solutions includes the NCT system, a special technology for non-contact gripping. Vacuum technology ensures precise, secure, ultra-efficient processes that are gentle on materials.

The right components for automation solutions

The quality of individual product components is one thing – the experience to be able to transform them into a system is another. We offer you a perfect combination of both. Your benefit: As a comprehensive provider of pneumatics solutions, Emerson also makes sure that the vacuum systems are efficiently integrated into all your application's automation processes.

Our Expertise – our benefit

It's not enough to just offer components, which is why Emerson never loses track of the big picture. Our mission is to create solutions tailored to your specific requirements that are both well thought out and state-of-the-art. So, utilize our product and industry experience for your application! After all, good components, a suitable configuration, and the right accessories are one thing, but experience is crucial if you want to transform them into perfect automation solutions.

- Industry and application expertise in all areas of pneumatic automation
- Specialist for customer-specific solutions
- Pioneering components and systems for IoT applications

Tell us what we can do for you or configure your own solution with our free Engineering Tools. Starting with choosing the right vacuum cup depending on the type, shape, and surface of the workpiece to be moved, to cycle-time-optimized configuration of the suction capacity, through to vacuum system monitoring.



Expertise – finely-tuned overall solutions, not simple standalones.

Gripper technology

Different components for gripping and moving: non-contact, vacuum-based, or mechanical



Vacuum accessories

Important accessory components for mounting, connectivity, and system monitoring



Vacuum generator

High-tech ejectors for application-specific vacuum generation



The right gripper and vacuum solution for every handling application

Get some insight, an overview, a preview

This brochure will help you choose the right systems and components for your application. It provides information on major functions, preferred uses, and features. A summary of the program at the end of the brochure serves as an introduction to our detailed catalog.

Comprehensive range with innovative features

Because vacuum technology follows very special principles, safe vacuum operation and suitable component design require very specific expertise. Relative and absolute vacuum values, the effect of the natural atmospheric pressure, the holding force depending on the vacuum and effective surface of a vacuum cup, optimized energy needs when generating the required vacuum level, reliable control and monitoring of vacuum circuits – you can safely assume that we know what we're doing. Our decades of experience in successfully implementing vacuum applications in a wide range of industries is reflected in every aspect of our comprehensive vacuum offering. And the best part: All the components are a perfect match for each other, proven in practice.

- Vacuum generators with all options
- Components for gentle gripping
- Accessories for optimized overall solutions

All components and systems are perfectly matched

In vacuum technology, finding the right system configuration isn't all that simple. But there are ways to make it as easy as possible. The easiest: Just contact our specialists for an expert consultation. Or, you can start by using our proven Engineering Tools. Either way, we will find the right vacuum solution for you together.

Vacuum generator

Single-stage ejector

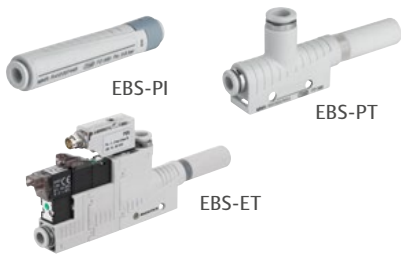

Pages 8-9

Multistage ejector



Pages 8-9

Compact ejector



Pages 10-11

Non-contact grippers

NCT non-contact transport



Pages 12-13

Vacuum grippers

Flat suction cups/bellows suction cups



Pages 14-15

Mechanical grippers



Pages 16-17

Vacuum accessories

Filters, adapters, sensors, displays, flow valves

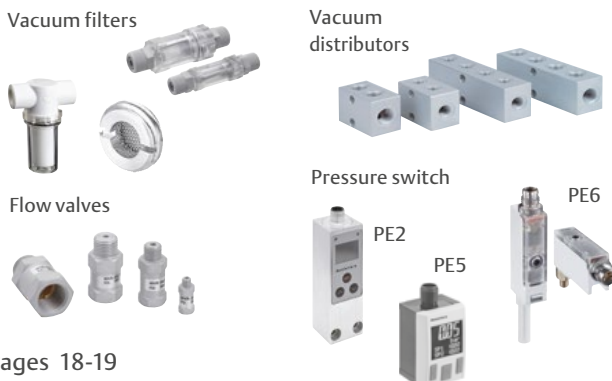

Pages 18-19

Mounting elements, fittings, tubing



Pages 20-21

Optimized vacuum generation based on the Venturi principle

Italian physicist Giovanni Battista Venturi discovered and analyzed the correlation between cross-section narrowing and flow speed as early as the 18th century. Today, the principle named after him is used in many technical applications, forming the core of vacuum ejectors in pneumatics – perfected by Emerson.

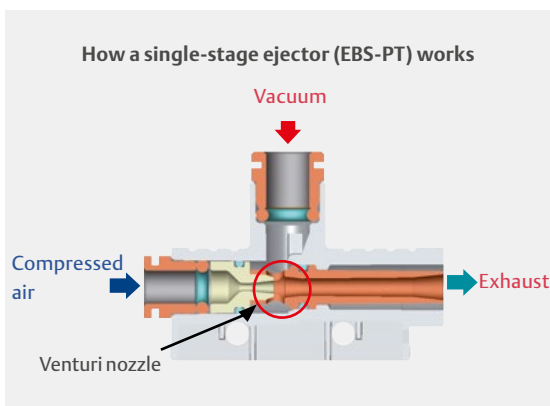

Our vacuum ejectors work according to the Venturi principle. The supplied compressed air flows through the nozzle, which accelerates and compresses it. Directly downstream of the venturi nozzle, the accelerated air decompresses, resulting in an underpressure which causes the air to be suctioned through the vacuum connection. The suctioned air and the compressed air exit through the silencer.

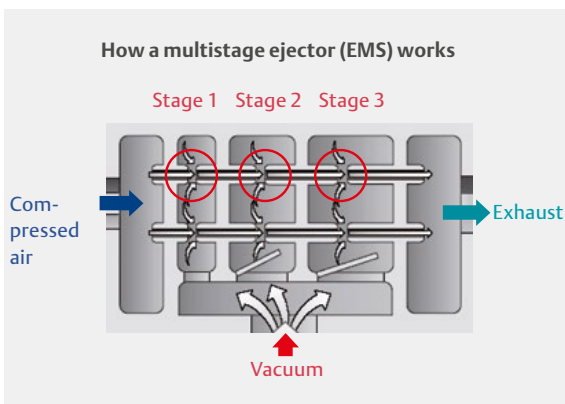

Efficient vacuum generation

In general, three methods can be applied to generate a vacuum: electrical pumps, electrical blowers, or pneumatically operated ejectors. In pneumatics, vacuum ejectors based on the Venturi principle are used to develop the required suction capacity and high vacuum level.

As diverse as their applications

Our products range from simple inline ejectors for direct installation into tubing connectors on the vacuum cup to decentralized compact ejectors with additional integrated functions and automatic air economizers. Suction capacities of 6 to 600 l/min are possible depending on the application. Single-stage and multistage ejectors are available with different compact, lightweight equipment configurations that are easy to integrate, quickly establish a vacuum, and are wear-free and extremely maintenance-friendly.

- Single-stage ejectors for direct installation into vacuum lines
- Multistage ejectors for an increased suction volume
- Compact ejectors with fully integrated functions and air economizers

Single-stage/multistage ejectors

EBS-PI series

Inline ejectors are designed for direct installation in the vacuum line. They are ideal for space-saving solutions.



EBS-PT/ET series

EBS series ejectors feature a particularly lightweight, compact design. They are available with or without vacuum switch and are ideal for space-critical situations and dynamic processes. The EBS-ET version with electrical control is intended for cycle-time-optimized applications.

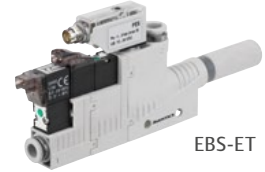

EMS series

Enormous suction capacity with maximum efficiency – the multi-stage ejectors with multiple Venturi nozzles connected in series offer a very high suction capacity, making it possible to handle workpieces with difficult-to-seal surfaces.

- High-flow version (HF) for porous workpieces
- High-vacuum version (HV) for air-tight workpieces



EMS series multistage ejectors are available in two basic versions and three performance categories for various workpiece conditions. Thanks to the extremely high flow, even porous parts, or workpieces with uneven surfaces can be handled safely.

Vacuum generators /single-stage ejector

Series		Suction capacities	Vacuum level max.
EBS-PI		8 - 15.9 l/min	83 - 85%
EBS-PT		7 - 215 l/min	82 - 86%
EBS-ET	electro.	7 - 223 l/min	84 - 86%

Vacuum generators / multistage ejector

Series		Suction capacities	Vacuum level max.
EMS 25		252 l/min	90%
EMS 50		432 - 445 l/min	90%
EMS 100		822 - 856 l/min	90%

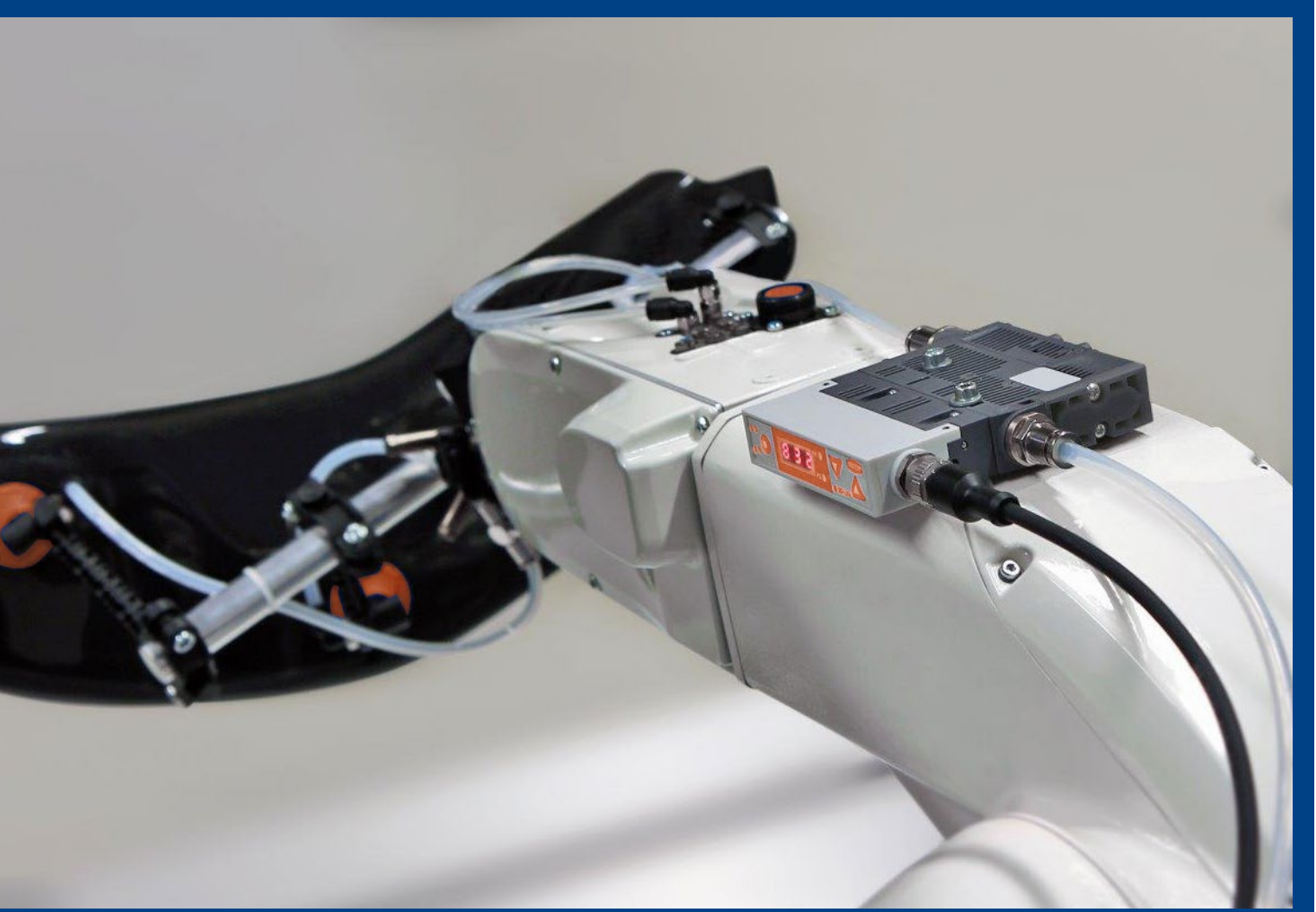

Packing a punch: ejectors with additional integrated functions

Compact ejectors offer more technical functionality and simplicity

Compact ejectors combine vacuum generators, pilot valves, filters, switches, and silencers in one turnkey unit. As a result, none of the individual components must be tuned separately, cutting down the time required for installation.

Up to 90% less consumption with air economizer function

Air economizers conserve up to 90% of the compressed air energy! Vacuum generation is controlled via the integrated solenoid valve and precisely adjusted to provide the required vacuum.

Compact ejector

ECD series

From Basic, Smart, Intelligent, to Large: ECD series ejectors are available in four modular versions with functions, sizes, and features that can be selected as needed.

- Ejectors with display and IO-Link
- Comprehensive setting and display options
- Condition monitoring, energy monitoring
- With integrated air economizer function



ECD-BV (Basic Version)
Pilot valves for vacuums and blow-off



ECD-IV (Intelligent Version)
Integrated air economizer function, display, and condition monitoring via IO-Link



ECD-SV (Smart Version)
Integrated air economizer function and powerful LED bar display



ECD-LV (Large Version)
Integrated air economizer function, display, and condition monitoring via IO-Link



Vacuum generator / compact ejector

Series		Suction capacities	Vacuum level max.
ECD-BV		35 - 64 l/min	85%
ECD-SV	 LED display	35 - 64 l/min	85%
ECD-IV	 IO-Link	35 - 64 l/min	85%
ECD-LV	 IO-Link	117 - 170 l/min	87%



For ultra-sensitive or perforated objects and surfaces: non-contact grippers based on the Bernoulli principle

Our non-contact transport systems make for a unique gripping experience: The floating suction pads in the NCT series are ideal for sensitively handling delicate surfaces and difficult-to-grasp materials – in a virtually non-contact and extremely gentle process. The NCT can even handle a large degree of perforation and can cope with contaminated, wet, and dusty surfaces, or soft materials.

Smooth running with the NCT series

The targeted control of compressed air and air flow generates a differential pressure and lifting force between the transport unit and the object. As a result, workpieces can be lifted and moved friction-free with virtually no surface contact at all, and without causing any damage or deformation.

Non-contact grippers

NCT-AL (aluminum) series

The NCT-AL series floating suction pads are ideal for applications in the electronics, pharmaceuticals, or telecommunication industries. They handle products like food, solar modules, or electronic circuit boards with a large degree of perforation.



NCT-PK (PEEK) series

NCT-PK series grippers made of polyetheretherketone are designed for special requirements in the food and semiconductor industries and enable direct contact with foods or silicon.



Non-contact grippers – Non-contact transport NCT

Series		Diameters	Lifting force
NCT-AL		20 - 100 mm	2.5 - 46 N
NCT-PK		20 - 60 mm	2.5 - 12 N

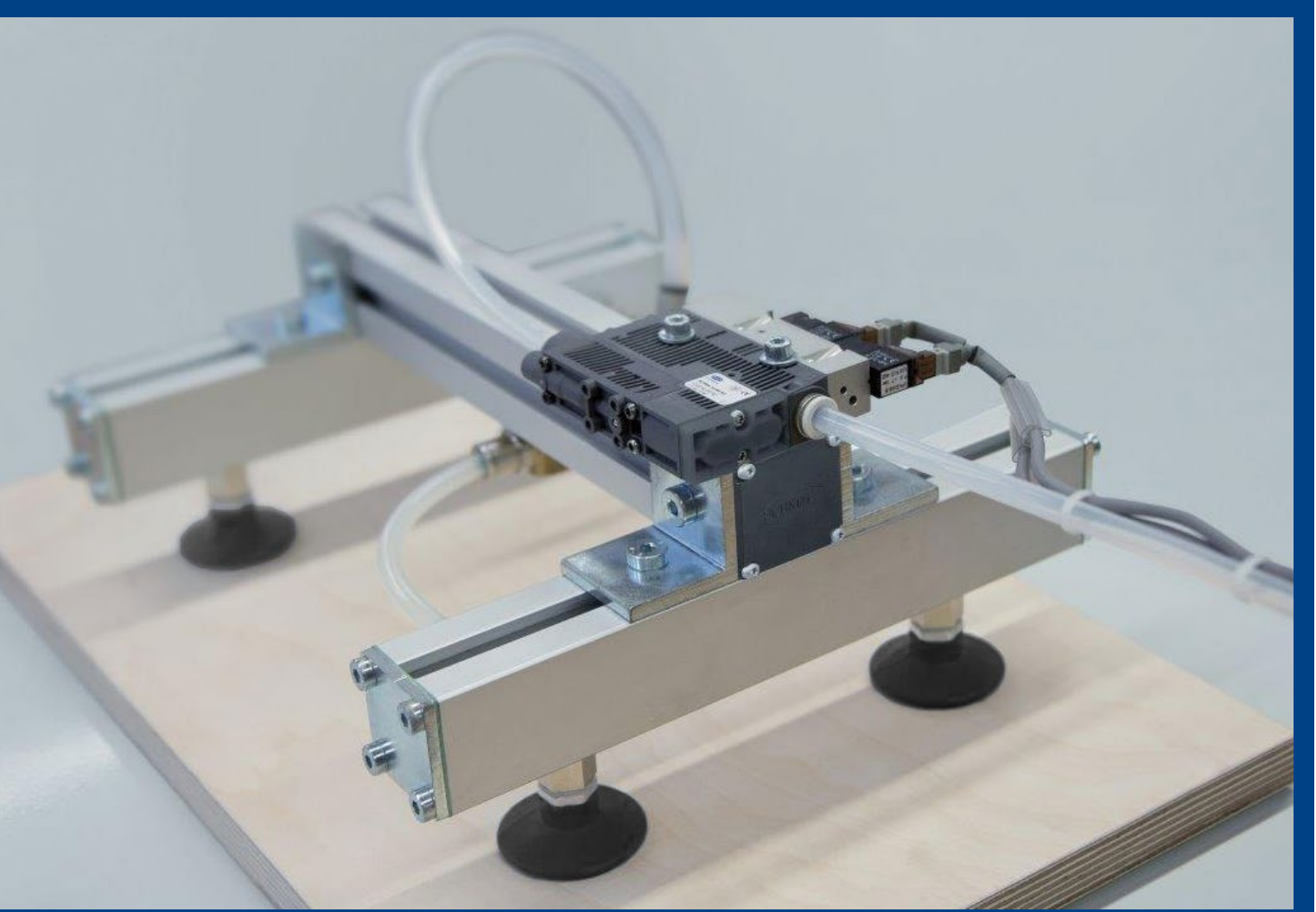

An entire range of vacuum suction cups for gentle lifting and movement

The name is slightly confusing since no actual suctioning takes place. Instead, an underpressure is generated inside the gripper, and the ambient pressure pushes the workpiece against the gripper. As always – the solution has been perfected by Emerson.

Vacuum suction grippers

FSR series, SGN series, FSG series

As a universal gripper, round flat suction cups are the right choice for many standard applications with level, flat workpieces. They are available in a wide range of sizes up to diameters of 300 mm.



FSR series, SGN series, FSG series

FSO series

Oval flat suction cups are ideal for long and cylindrical workpieces. Thanks to their oval shape, the contact surface available for establishing the vacuum is increased and optimized.



FSO series

BSA series, BSG series

The bellows suction cups are available with 1 1/2 and 2 1/2 bellows. They are suitable for workpieces with curved or inclined surfaces, as well as to compensate for height tolerances or to handle large-surface, non-rigid components such as large, thin sheets.



BSA series, BSG series

Vacuum suction grippers – Flat suction cups / Bellows suction cups

Series		Diameters	Holding force
FSR		30 - 300 mm	16 - 2560 N
SGN		6.3 - 30 mm	1.5 - 35 N
FSG		1 - 147.5 mm	0.03 - 842 N
FSO		2.2 - 90 mm	3.1 - 112.6 N
BSA		5 - 89 mm	0.1 - 45.2 N
BSG		10.4 - 150 mm	0.95 - 570 N

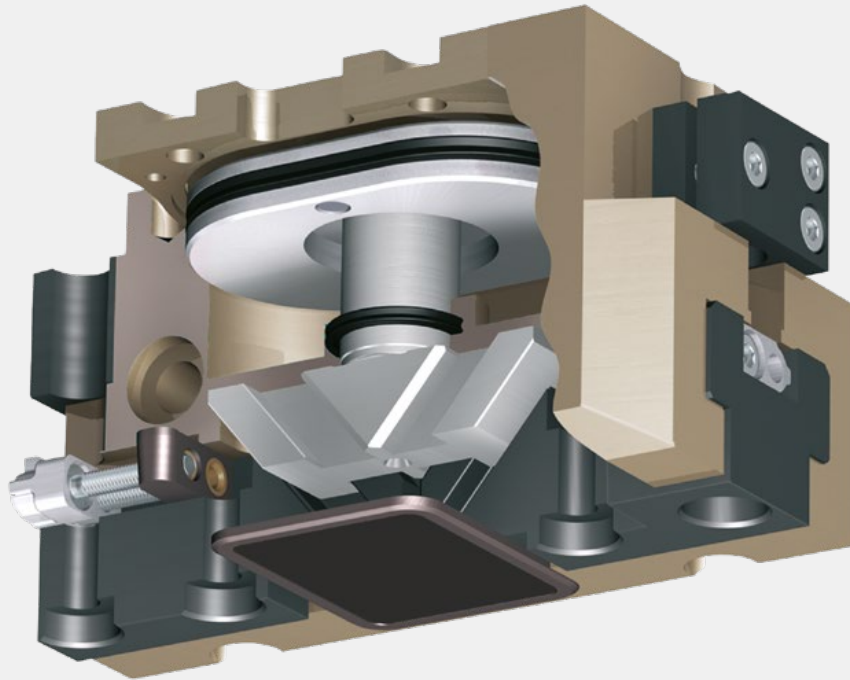

For tasks requiring a high gripping force: pneumatically controlled mechanical grippers

Whether round or angular, super light or heavy, with irregular shapes and difficult materials – the types and versions of parts and workpieces to be moved are many. As versatile as the gripping tasks may be, Emerson has the right solution for every automated handling requirement.

Graduated range of grippers for many standard applications

Our pneumatically controlled mechanical grippers are 2-finger parallel grippers characterized by their high gripping forces, precision, and exact movement of the clamping jaws. They can be selected based on the application requirements and flexibly equipped with object-specific gripper fingers. Force transfer from the working piston to the base jaws via the kinematics with wedge hook principle ensures synchronous gripper control.

Mechanical grippers

UPG series

With seven sizes, the UPG series covers performance needs for virtually any standard application in pneumatic automation. Thanks to their robust kinematics and compact design, these grippers can be used anywhere in handling technology for universal applications.

- Parallel grippers in seven sizes
- Wide range of gripping forces up to 2000 N
- Interface to the Easy-2-Combine modular system

The stable mounting options for gripper fingers make assembling the grippers and exchanging the gripper fingers easy and safe.

UPG-40



UPG-50



UPG-64



UPG-80



UPG-100



UPG-125



UPG-160



Mechanical grippers

Series		Stroke per jaw	Closing force
UPG-40		2.5 mm	123 - 163 N
UPG-50		4 mm	140 - 185 N
UPG-64		6 mm	250 - 340 N
UPG-80		8 mm	415 - 570 N
UPG-100		10 mm	660 - 900 N
UPG-125		13 mm	1080 - 1470 N
UPG-160		16 mm	1640 - 2210 N



Matching vacuum accessories for the perfect overall solution

Accessories are simply a necessity – no more, no less. You may not realize just how critical accessories are until you are missing one. This is why we place a special focus on the details, tailoring your application for high performance.

Vacuum accessories – Vacuum filters and Vacuum distributors

Vacuum filters and distributors ensure clean, efficient vacuum supply

Efficient, trouble-free continuous operation of a vacuum system requires loss-free distribution of high-quality operating air. Special vacuum filters are used to reliably protect the vacuum generators from contamination and damage due to external influences. As a prefilter or microfilter, they can be equipped in two different pore widths for various degrees of contamination. In systems with multiple vacuum cups and a central vacuum generator, aluminum distributors with integrated mounting options distribute the compressed air and vacuum.

Vacuum filters



Vacuum distributors



Vacuum accessories – PSL spring-loaded plungers and angle joint connections

Mounting with rigid fitting, spring-loaded plunger, or angle joint

The mounting elements are not only there for vacuum cup mounting but provide important additional functions. Depending on the properties and positioning of the workpiece, there are generally three options for mounting vacuum cups: rigid, spring-loaded, or with a flexible coupling. This allows compensation for inclinations or differences in height, for example.

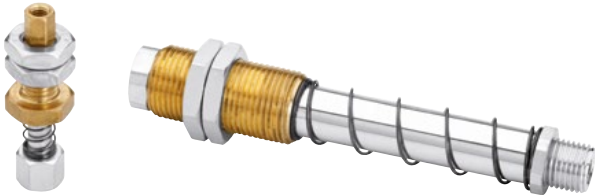

PSL Spring-loaded plungers



Angle joint connections

Vacuum accessories – Filter, Flow control valves, Fasteners

Series		Max. load	Designation
PSL		47 - 1870 N	PSL Spring-loaded plungers
AJT		500 - 3000 N	Angle-joint
Series		Flow	Connections
VFI			G1/8, G1/4, G3/8, G1/2
VFI		32 - 66 l/min	Ø 4, Ø 6
VFC		45 - 600 l/min	G1/8, G1/4, G3/8, G1/2, G3/4
VCK		80 - 750 l/min	M5, G1/8, G1/4, G3/8, G1/2

Vacuum accessories – Pressure sensor

Flow valves for reliable, efficient processes

Flow valves secure the vacuum in the system. If a leak occurs, for example due to a workpiece becoming detached at a vacuum cup, the flow valve automatically closes. In addition, flow valves enable efficient workpiece handling with variable dimensions since the flow is automatically switched off when vacuum cups are not in use.

Flow valves



Vacuum accessories – Flow valves

Everything under control with the right sensor components

To be able to detect and eliminate errors or malfunctions in the system early on, it is always essential to have an overview of all important parameters. Our pressure gauges, switches, and sensors are the perfect solution.

- Vacuum system monitoring
- Continuous information on the system status
- Error reporting and increased process reliability

In addition to pure system monitoring, additional features focus on optimized cycle times, control loops, and power management.



Vacuum accessories – Push-in fittings and Connection tubing

Fittings and tubing ensure secure pneumatic connections

In a vacuum circuit, the tubing and fittings perform a very important task. To ensure continuous error-free, efficient function, they must be secure, leak-tight, and made of the right materials. When configuring the overall system, the tubing also must be dimensioned exactly.

Push-in-fittings



Connection tubing

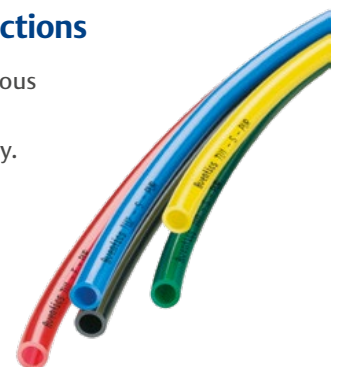

Vacuum accessories – sensors, display, tubing, fittings

Series		Connections	Designation
PE2		G1/4 Flange Ø 5 x 1,5	Electronic pressure sensor
PE5		G1/4 Plug-connection Ø 4	Electronic pressure sensor
PE6		Flange Ø 1,2 x 1	Electronic pressure sensor
QR1-S mini		Ø 3 - 6 M3 - G1/8	Push-in fittings
QR1-S standard		Ø 4 - 16 M5 - G1/2	Push-in fittings
QR2-S standard		Ø 4 - 16 M5 - G1/2	Push-in fittings
QR2-C stainless steel		Ø 4 - 12 M5 - G3/8	Push-in fittings
TU1		Ø 4 - 16	Polymer tubing, polyamide
TU1		Ø 4 - 22	Polymer tubing, polyamide
TU1		Ø 3 - 16	Polymer tubing, polyurethane

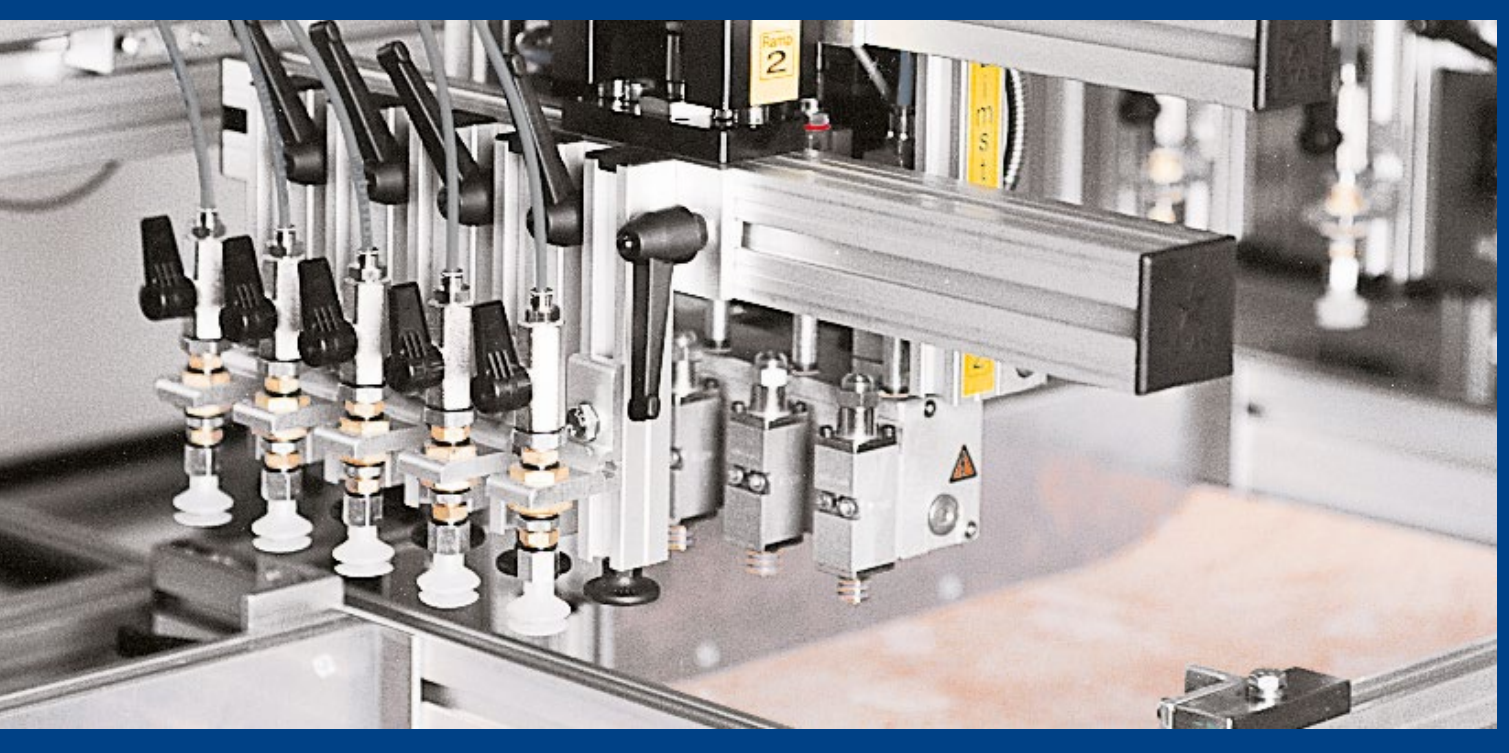

Let's solve your task together! Our expertise – your benefit

Optimized system configuration in just seven easy steps

1. Define specifications for the workpiece
2. Determine the required gripping force
3. Select the right vacuum cups
4. Select specific mounting elements
5. Dimension the tubing diameter
6. Calculate the total volume to be evacuated
7. Select the vacuum generator

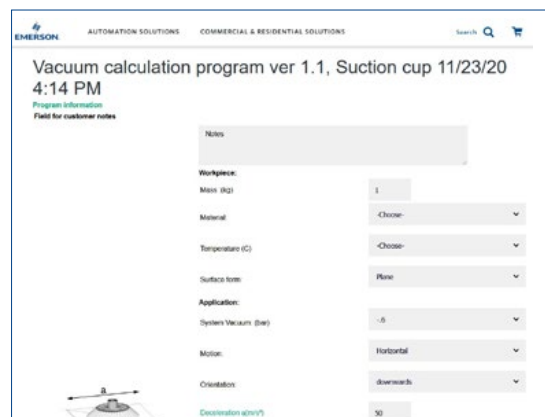
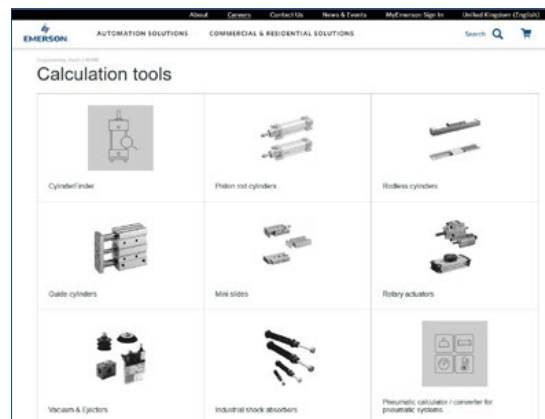
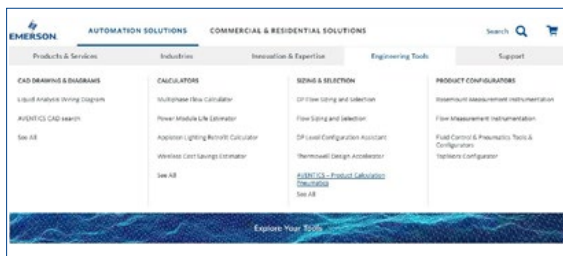

Visit Service & Support on our website www.emerson.com to find our Engineering Tools, including calculation programs to size products for your applications. You will find additional basic information in the “Technical Information” documentation.

A single online shopping experience to meet your complete fluid control and pneumatics requirements

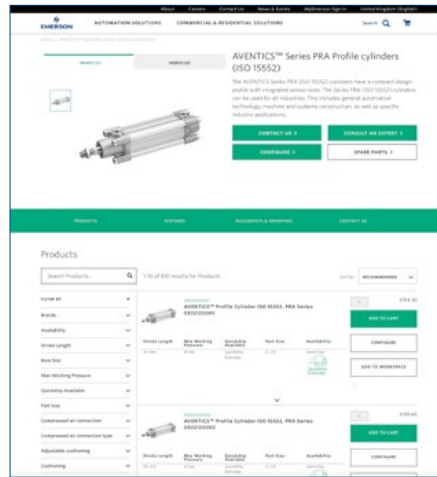
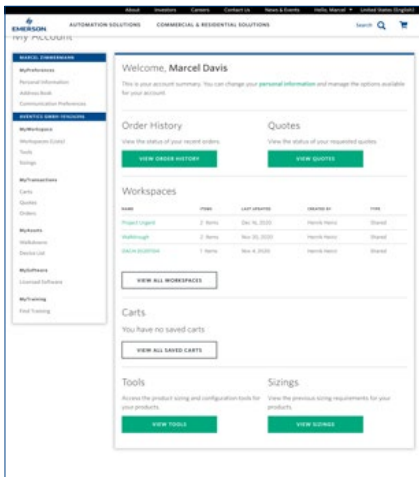

- Unified product catalog and store for all Emerson products
- Integration of spare parts and accessories
- Search and filtering functions
- Register without an existing customer number
- Download technical documents and CAD drawings
- Access available 24/7, 365 days a year
- Tracking your order and shipment status
- Prices and availability immediately visible
- Discounts and net prices displayed
- Manage multiple ship-to locations and create a shopping list for projects

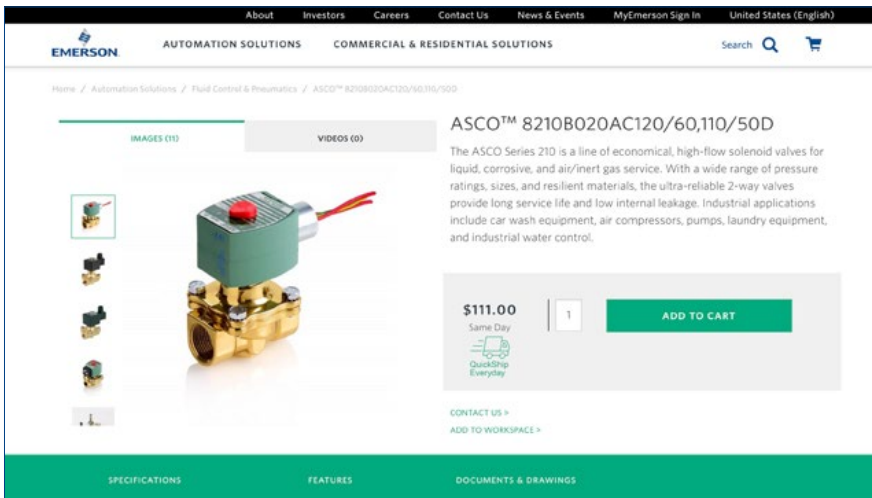

Focused on you - MyEmerson



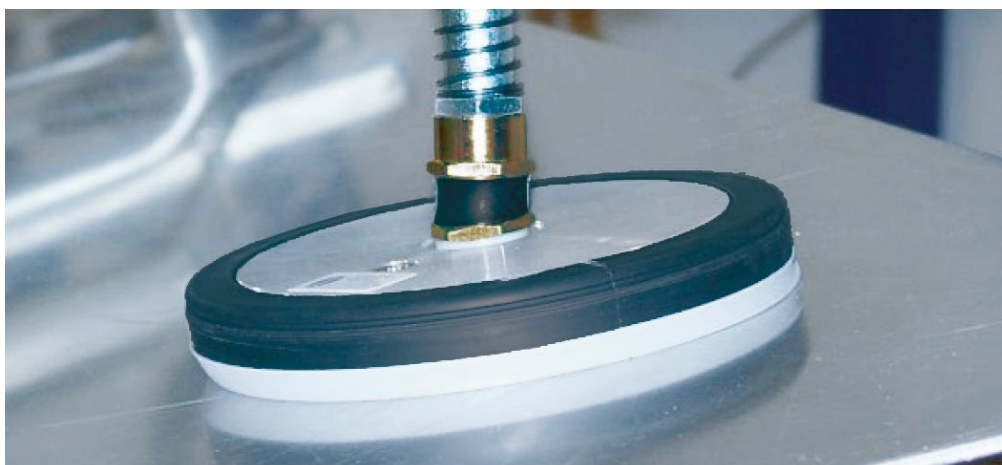

To simplify purchasing fluid control and pneumatics products, Emerson provides a single online store for its ASCO and AVENTICS brands. The MyEmerson personalized digital customer experience at Emerson.com offers a range of features and functionality via a single login, including an overview of orders, delivery tracking, and easy access to downloadable product documentation. A convenient single-sign-on will facilitate the log-in process while avoiding logins on several platforms like our online configurators. MyEmerson features an overview of orders, track deliveries, and download options for all relevant documents.

The online store and digital customer experience includes the entire pneumatics range and comprehensive expertise and support at one convenient location – [Emerson.com/en-us/automation/fluid-control-pneumatics](https://www.emerson.com/en-us/automation/fluid-control-pneumatics)

The right gripper and vacuum solution for every handling application



Visit us: [Emerson.com/aventics](https://www.emerson.com/aventics)
Your local contact: [Emerson.com/contactus](https://www.emerson.com/contactus)

-  [Emerson.com](https://www.emerson.com)
-  [Facebook.com/EmersonAutomationSolutions](https://www.facebook.com/EmersonAutomationSolutions)
-  [LinkedIn.com/company/Emerson-Automation-Solutions](https://www.linkedin.com/company/Emerson-Automation-Solutions)
-  [Twitter.com/EMR_Automation](https://twitter.com/EMR_Automation)

The Emerson logo is a trademark and service mark of Emerson Electric Co. AVENTICS is a registered trademark of one of the Emerson family of companies. All other marks are the property of their respective owners. © 2021 Emerson Electric Co. All rights reserved. BR000064ENUS-02_04-21



CONSIDER IT SOLVED™