

**Expand process insights with  
fast, high-resolution multi-  
component gas analysis.**

## **Rosemount™ Continuous Laser Gas Analyzers**

Optimize your process with enhanced target gas selectivity and sensitivity using the industry's first hybrid QCL/TDL laser gas analyzers.



# Expand Insight and Optimize Performance

Improving productivity, managing emissions, and ensuring quality are daily challenges for operators – and areas of focus for regulators. Changes in processes, regulations, and workforce are pushing engineers, specialists, and technicians in every industry to seek out powerful but easy-to-use technologies that reduce the burden of gas analysis and improve overall operations.

## What if you could...

### **Improve Process Control with Fast and Reliable, Real-time Data**

- Multi-component analyzer delivers real-time measurement for greater and faster insight into the process.
- Analysis of up to ten different gases – in a single instrument – provides broader application flexibility and process insights.
- Solid-state components deliver reliable measurement and decades of laser life for improved quality and increased uptime.

### **Lower Costs with Easy Installation, Operation and Maintenance**

- Modular, simplified design improves reliability, enables easy upgrades, reduces plant maintenance and simplifies technician's procedures.
- Future-proof analyzer inventory with easy in-field upgrades and maintenance.
- Installation and commissioning ease, including one-day technician training and startup.
- Avoid costly shelters and enclosures to reduce installation cost and avoid additional field maintenance.

### **Ensure Safety and Compliance with Superior Reliability**

- Sub-second measurements ensure operators can make adjustments to avoid upsets that might develop into emergencies.
- Accurate, reliable measurement of complex gases and emissions ensures regulatory compliance and prevents costly fines.
- Compact and rugged laser modules and field-tested devices designed for extreme operating environments in regulated industrial markets.

# Quantum Cascade & Tunable Diode Laser Analyzers

Emerson's advanced CT4000 and CT5000 Series Analyzers incorporate both Quantum Cascade Laser (QCL) and Tunable Diode Laser (TDL) technology to deliver the most sophisticated industrial gas sensing, analysis, and emission monitoring solution.

Features	Benefits
First hybrid QCL and TDL analyzer	Realize true savings from a more powerful device that gives greater process insight and analysis.
Multiple component measurement in a single device	Detect, analyze, and monitor up to ten different gases and eliminate the need for multiple analyzers and sample handling systems.
Simple field service and upgrades	Simplify installation, commissioning, upgrades, and any required maintenance with intuitive user interface and all solid-state components.
Reliable operation	Improve uptime with rugged design for extreme environments, and 374 °F (190 °C) maximum sample cell operating temperature.
No consumables	Avoid expense and hassle of high amounts of gas consumables in daily operation.
No costly shelters or enclosures	Lower installation costs with in-the-field wall-mount or rack-mount configurations.
Calibrations seldom required	Reduce the need for validation/calibration frequency with inherent calibration stability.

## Process Industries

- Petrochemical
- Oil and Gas
- Power
- Industrial Energy
- Gas Processing
- Marine
- Research and Development

## Typical Applications

- Ethylene Production / Purity
- Continuous Emissions Monitoring
- NOx Reduction / Ammonia Slip
- Natural Gas / Biogas
- Hydrogen / Nitrogen Purity



Rosemount CT4400 Continuous Gas Analyzer



Rosemount CT5800 Continuous Gas Analyzer



Rosemount CT5100 Continuous Gas Analyzer



Rosemount CT5400 Continuous Gas Analyzer

# Quantum Cascade Laser Technology

Emerson's Quantum Cascade Laser (QCL) technology offers fast, high-resolution spectroscopy to detect and identify a range of molecules in the mid-infrared wavelength range. Coupled with Tunable Diode Laser (TDL) spectroscopy, a single instrument is now able to provide greater insight and monitoring in both the near and mid-infrared range of spectroscopic light.

Quantum Cascade Lasers are semiconductor devices which produce light in the mid-IR region. They are fabricated to emit light at a desired wavelength and are made to scan a spectrum using a laser chirp technique. To start the process, a QCL is pulsed with electrical energy and heats up. As the temperature increases, the wavelength of the emitted light also increases. A laser chirp lasts about one microsecond and in this time a spectrum of between one and three wavenumbers is scanned.

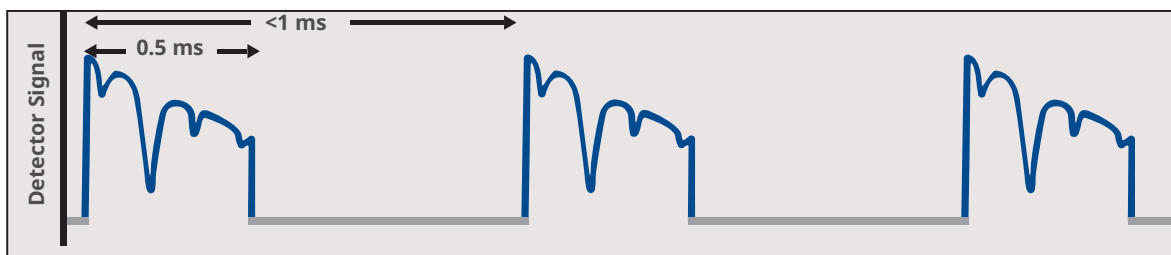

The raw detector signal is then processed to convert it into a spectrum from which the concentration of analytes can be calculated. QCLs can be chirped at a frequency of up to 100 kHz, enabling many thousands of spectra to be gathered in a few seconds and processing these spectra gives a strong signal with a good signal-to-noise ratio.

The scanned wavelength region is selected to enable measurement of the desired analytes and it is often possible to detect more than one compound with a single QCL device. An advanced signal processing procedure enables real-time validation of measurements and greatly reduces the need for calibrations.

QCL systems include up to six high-resolution lasers to measure both the near- and mid-infrared spectral regions for real-time, optimal gas measurement and analysis down to sub ppm concentrations.

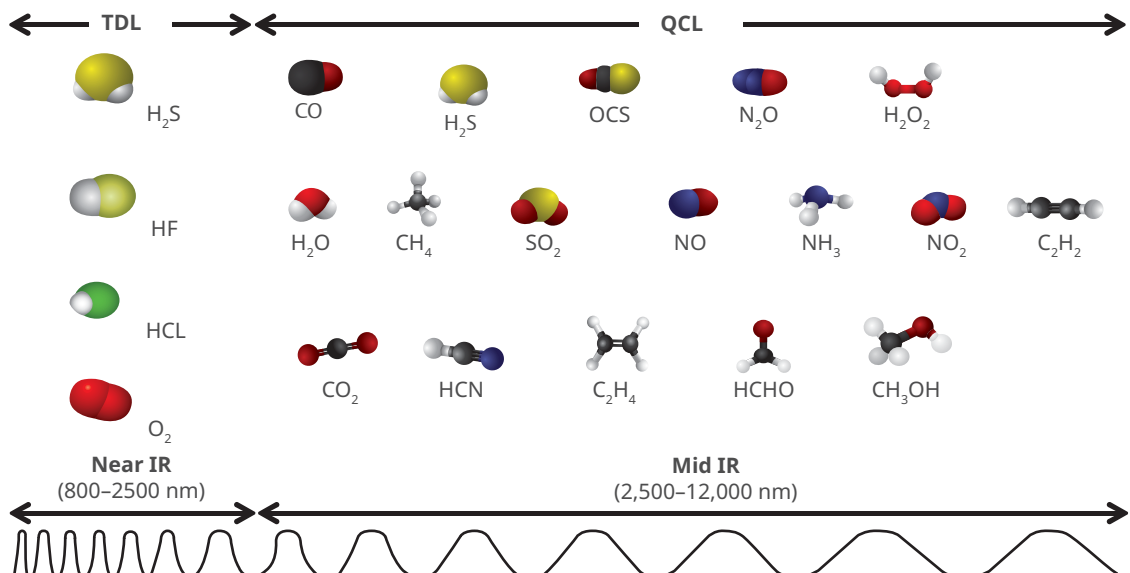

Rosemount QCL/TDL technology with patented laser chirp technique expands gas analysis to both the near and mid-infrared range to enhance process insight, improve overall gas analysis sensitivity and selectivity, remove cross interference and decrease response time.

### Simultaneous Gas Analysis

Up to six laser modules and patented laser chirp data capture technique isolates and analyzes up to ten unique gas components.

1. **Optical bench base plate** – superior rigidity for continuous, high accuracy measurement that is immune to vibration and temperature changes
2. **Smart laser modules** – unique and sequenced laser chirp for fast, multi-component measurement
3. **Optical path mirrors** – direct light, rigid connection to base plate to ensure alignment
4. **Multipass Flow Cell** - designed to extend optical path length for greater resolution of low component (or analyte) concentrations
5. **Detector** - ultrafast detection of emitted light

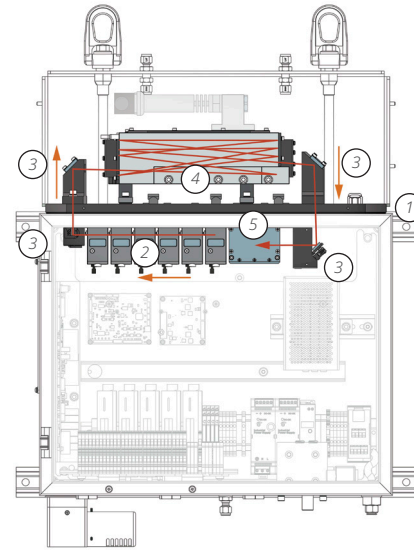

CT5100 Optical Bench

### Enhanced Gas Analysis Sensitivity and Selectivity

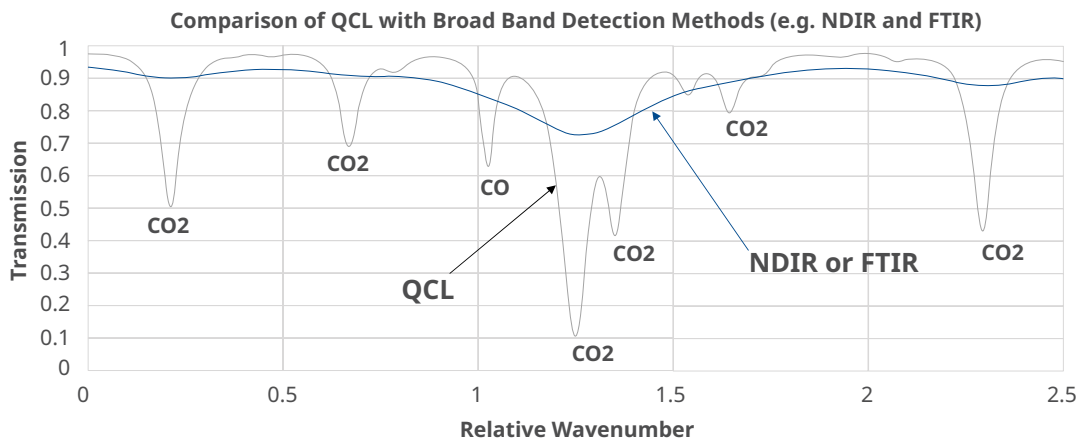

QCL and TDL narrow line width allows scanning of individual peaks of identified components with minimum interference and without filtration, reference cells, or chemometric manipulations.

### Rugged and Reliable Hybrid QCL/TDL Laser Module

- Modular architecture is easily serviceable and upgradeable in the field
- Packaged lasers are housed in rugged modules that can be repeatedly mounted/un-mounted to the optical bench without losing alignment
- Module is preconfigured with its unique characteristics for the QCL device
- Stable dowel mount with two screws and one ribbon cable ensure reliable operation in process environments
- Expert laser light alignment is factory set with no field alignment required



# Ethylene Fractionator Control and Real-Time Product Certifications



Ethylene is one of the most important organic compounds made in the world today. It is a building-block chemical needed to manufacture many commercial products. Nearly half of the world demand for ethylene is for polyethylene production, but it is also used to make vinyl chloride, ethylbenzene and many other valuable intermediate products such as ethylene oxide, ethanol ethylene oxide, and ethanol.

## What's your challenge?



The goal of an ethylene plant is to produce 99.99% pure product. The final purification step is made in an ethylene fractionation tower, or splitter. Analysis is required for process control of the fractionator in order to ensure on-spec production. Once the ethylene product leaves the splitter, its purity must be certified before distribution by pipelines or ships.

## What's your opportunity?



What if you could have fast analysis times and high sensitivities to optimize process control of your fractionator tower? What if you could carry out online certification of ethylene product purity in a single analyzer while lowering the total lifecycle cost associated with maintaining your system?

## Typical Ethylene Fractionator

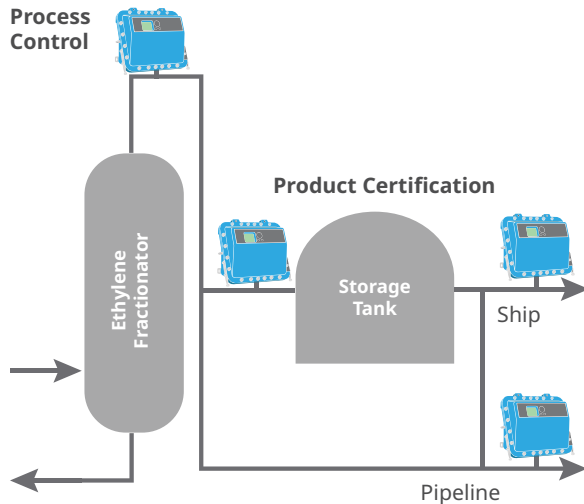

## Measurement Ranges

		Measurement Range in Ethylene			
		Components	Range <sup>1</sup>	LOD <sup>2</sup>	Units
Process Control	Methane		0-1000	5	ppm vol
	Acetylene		0-20	0.2	ppm vol
	Ethane		0-500	5	ppm vol
	CO		0-5	0.05	ppm vol
	CO <sub>2</sub>		0-5	0.05	ppm vol
Adders for Product Certification	Ammonia		0-20	0.2	ppm vol
	Water		0-20	0.2	ppm vol
	Methanol		0-100	1	ppm vol

<sup>1</sup> Components and ranges are indicative. Analyzer requirements will depend on complete gas list. Detailed specs will be provided during the ordering process.

<sup>2</sup> Repeatability  $\pm 1$  percent of reading or the Limit of Detection (LOD), whichever is greater.

## Meet Ethylene Purification and Certification Demands Using Rosemount CT5800 Continuous Gas Analyzer

- Measure multiple gas components in a single analyzer for reduced total cost of ownership
- Gain faster process insights with measurement update time of <1 second, ensuring reliable process monitoring and control
- High sensitivity and selectivity allow the detection of multiple components and trace impurities simultaneously while remaining immune to cross-interference effects for greater measurement reliability
- Field-mountable design reduces the need for expensive analyzer shelters and long sample transport line
- Certified flameproof enclosure simplifies installation in hazardous areas
- Patented laser chirp technique analyses the gas continuously down to sub-ppm concentrations, enabling sub-second measurements in real time



## Lower Operational and Maintenance Costs

- Real-time validation of process samples guarantees performance and minimizes field maintenance intervention
- Inherently stable spectroscopic technique extends calibration intervals
- Interchangeable modular components simplifies field service and upgrades
- Remote factory support, either by direct connection or by secure file exchange

# Continuous Emissions Monitoring



Regulatory requirements to monitor and report emissions are a necessary practice for global industries. However, understanding the evolving regulatory standards and selecting the right technology to monitor the emission of gaseous and particle pollutants can be a challenge. Continuous emissions monitoring systems (CEMS) help ensure compliance and, with highly accurate and reliable instrumentation, can even further improve the overall performance and insight into an operation.

## What's your challenge?



Environmental legislation continues to evolve and sets stricter limits on a range of atmospheric pollutants. Operators are challenged to ensure CEMS analyzers are reporting accurately to prevent costly fines or unexpected shutdowns.

## What's your opportunity?



The Rosemount QCL/TDL technology delivers superior emissions monitoring coverage with high reliability and low maintenance that assure greater analyzer availability.



## Typical CEMS Process

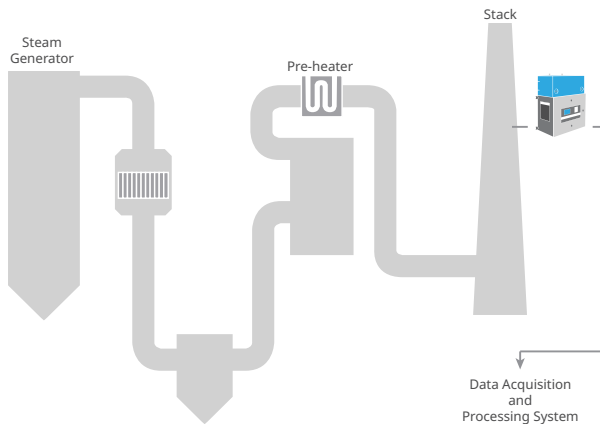

## Measurement Ranges

Component	Measurement Range		
	Range <sup>1</sup>	LOD <sup>2</sup>	Units
NO	0–20	0.2	ppm vol
NO <sub>2</sub>	0–20	0.2	ppm vol
NH <sub>3</sub>	0–15	0.1	ppm vol
CO	0–20	0.2	ppm vol
CO <sub>2</sub>	0–25	0.1	% vol
SO <sub>2</sub>	0–50	0.5	ppm vol
H <sub>2</sub> O	0–25	0.02	% vol
O <sub>2</sub>	0–25	0.05	% vol

<sup>1</sup> Components and ranges are indicative. Detailed specs will be provided during the ordering process.

<sup>2</sup> Repeatability  $\pm 1$  percent of reading or the Limit of Detection (LOD), whichever is greater.

## Ensure Reliable Analysis and Monitoring of Stationary Source Emissions

Rosemount QCL/TDL-based CEMS offers a unique and field-proven solution for monitoring up to ten critical gas components and pollutants to ensure environmental compliance and process optimization.

- Robust, accurate CEMS delivers the speed and reliability operators demand to ensure global, national, state, and local level regulatory compliance
- Hybrid, multi-component QCL/TDL system offers the most comprehensive analysis available for detecting a range of components in both the near and mid-infrared spectral range
- Patented laser chirp technique identifies and records thousands of measurements, ensuring repeatable monitoring of emissions
- Reduced consumables and calibration requirements simplify operation and maintenance
- Automated validation and/or calibration capabilities ensure reliable measurement performance
- Sample temperature up to 374 °F (190 °C) to keep hot/wet sample above acid dew point when required

## Reduce Total Cost of Ownership

- Simultaneous multi-component measurement
- Accurate and sensitive gas measurements
- Excellent linearity of response and repeatability
- Low, long term drift extends calibration intervals
- Low maintenance and low lifetime costs
- Continuous health diagnostic reporting
- Intuitive, simple front panel/user interface allows access to all instrument functions



Rosemount CT5100. Purged and pressurized enclosure for hazardous areas. Ideal for hot/wet CEMS applications.

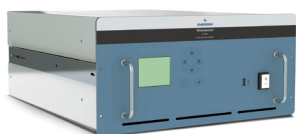

Rosemount CT5400. 19-in. rack enclosure for safe areas. Ideal for cold/dry CEMS applications requiring measurement of a large suite of gases.



Rosemount CT4400. Half-rack enclosure for safe areas. Ideal for cold/dry CEMS applications measuring standard components.

# NO<sub>x</sub> Reduction – Ammonia Slip



Nitrogen oxides (NO<sub>x</sub>) result from the combustion process in turbines, crackers, combustion engines, boilers, and other locations within a plant. As a powerful pollutant, it is important to control and contain NO<sub>x</sub> emissions. Both Selective Catalytic/Non-Catalytic Reduction (SCR and SNCR) are techniques used worldwide to remove NO<sub>x</sub>. However, this process can result in a by-product of unreacted ammonia or ammonia slip. Continuous measurement and monitoring of ammonia slip can be a challenge to ensure the sample integrity is maintained – especially in high dust, high-temperature applications.

## What's your challenge?



To adhere to environmental guidelines, operators must balance using the precise amount of ammonia – too much results in waste, not enough can lead to emissions.

## What's your opportunity?



The Rosemount QCL/TDL technology delivers measurement reliability and precision to ensure production is at its optimum, mitigating overdosing issues that result in both economic and environmental risks.

## Typical NO<sub>x</sub> Reduction Process

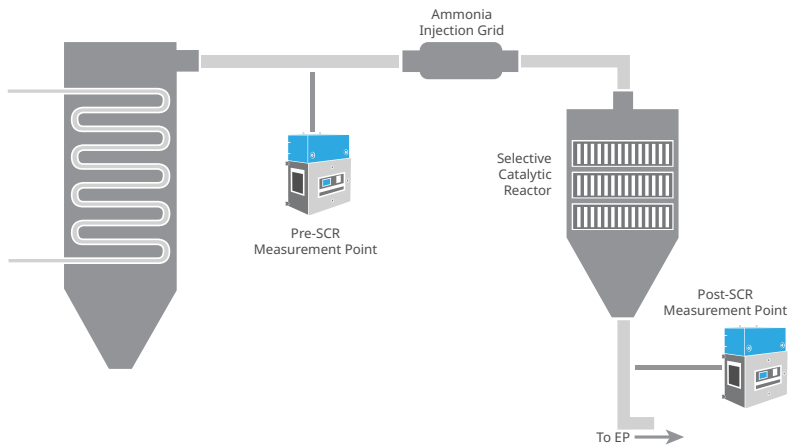

## Measurement Ranges

Location	Component <sup>1</sup>	Measurement Range		
		Range	LOD <sup>2</sup>	Units
PRE SCR	NO	0–700	0.5	ppm vol
	NO <sub>2</sub>	0–300	0.3	ppm vol
	CO	0–1000	1	ppm vol
	O <sub>2</sub>	0–21	0.15	% vol
POST SCR	NO	0–300	0.3	ppm vol
	NO <sub>2</sub>	0–150	0.2	ppm vol
	NH <sub>3</sub>	0–15	0.15	ppm vol
	SO <sub>2</sub>	0–1000	1	ppm vol
	O <sub>2</sub>	0–21	0.05	% vol

<sup>1</sup> Components and ranges are indicative. Detailed specs will be provided during the ordering process.

<sup>2</sup> Repeatability ±1 percent of reading or the Limit of Detection (LOD), whichever is greater.

## Get Tighter Control of Ammonia Slip and Optimize SCR Performance

Rosemount Quantum Cascade Lasers deliver the needed measurement precision to optimize SCR performance and contain NO<sub>x</sub> emissions.

- Interference-free monitoring of ammonia slip in the toughest environments
- Reliable, direct measurement without the need for converters
- Compact system operating at high cell temperatures (up to 374 °F/190 °C) brings the analyzer close to the sample probe for speed and added reliability
- Real-time measurement and analysis for dependable ammonia slip detection and insight into the efficiency of the plant's NO<sub>x</sub> reduction system
- Rugged, modular design delivers enhanced reliability and measurement stability in extreme operations
- Monitor up to ten critical component gases in industrial applications, toxic gas detection, and plant-wide emissions monitoring
- Reduced consumables and calibration requirements lower costs and simplify maintenance



Rosemount CT5100. Purged and pressurized enclosure for hazardous areas. Ideal for hot/wet applications.

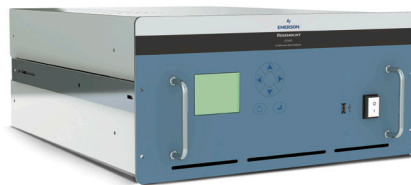

Rosemount CT5400. 19-in. rack enclosure for safe areas. Ideal for cold/dry applications requiring measurement of a large suite of gases.



Rosemount CT4400. Half-rack enclosure for safe areas. Ideal for cold/dry applications measuring standard components.

# Natural Gas Quality



As sources of natural gas become more diversified (e.g. shale gas, LNG, and renewable natural gas/ biomethane), operators must be able to ensure the composition of gas delivered – and received – is of sufficient quality per contractual agreements and pipeline quality and safety requirements. The increasing variability of the gas quality means that there is a greater need to measure the gas contaminants fast and accurately, often in remote locations with no on-site operators or maintenance personnel.

## What's your challenge?



Operators must be able to ensure the composition of gas delivered – and received – is of sufficient quality per contractual fiscal agreements, pipeline requirements, and safety considerations.

## What's your opportunity?



The Rosemount QCL/TDL technology provides rapid, reliable and highly accurate measurement to ensure natural gas meets quality standards and specifications. The high-resolution laser spectroscopy detects ultra-trace levels of impurities to mitigate pipeline corrosion and safety risks.

## Natural Gas Quality Process

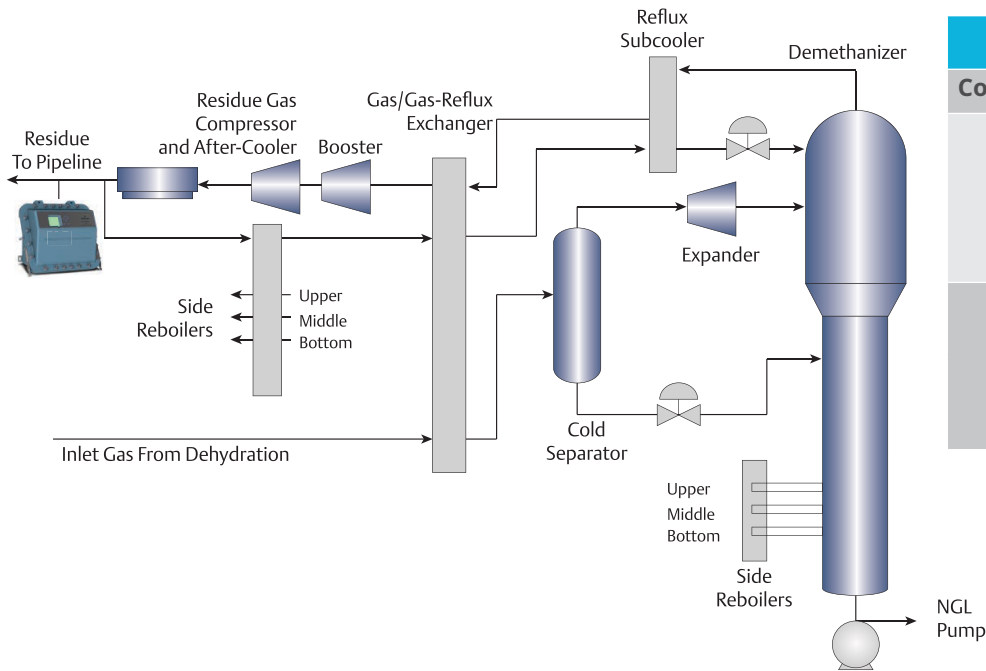

## Typical Measurement Ranges

Component	Measurement Range	
	Range	LOD
H <sub>2</sub> O	Low Range: 0-100 ppm	0.2 ppm
	High Range: 0-2500 ppm	5.0 ppm
CO <sub>2</sub>	Low Range: 0-1000 ppm	2 ppm
	High Range: 0-20%	0.04%

## Ensure Faster and Enhanced Monitoring of Natural Gas Quality

Satisfy fiscal and contractual obligations and ensure safe transportation of natural gas using Rosemount hybrid QCL/TDL laser technology for precise, consistent and sensitive analysis of product quality.

- Rapid, direct and interference-free detection and measurement of H<sub>2</sub>O, H<sub>2</sub>S, and CO<sub>2</sub> in the natural gas stream
- Part-per-million sensitivity levels and real-time measurement enable detection of trace impurities
- Update time of <1 second delivers critical monitoring of gas quality to mitigate problems within the process or downstream
- Outstanding reliability and stability in the most extreme of conditions and operations
- Reduced consumables and calibration requirements minimize costs and maintenance
- Easy-to-use instrumentation and fast technician training enable operational simplicity

## Streamline Gas Quality Measurements Using Rosemount CT5800 Continuous Gas Analyzer

- Unique cell design delivers highly accurate measurement of low concentrations of impurities in gas streams
- Designed for up to six Quantum Cascade Lasers
- Multi-component and simultaneous measurement in a single gas analyzer
- Flameproof enclosure for hazardous area applications
- Repeatable precision for consistent and sensitive analysis that ensures natural gas quality in a wide range of applications, including custody transfer points, gas processing, offshore/onshore production sites, storage facilities, and distribution networks



# Hydrogen / Nitrogen Purity



Assuring hydrogen and nitrogen gas purity is critical across multiple processing industries and applications. For several key processes, the purity of the gas must be precisely monitored and controlled to ensure the product is within specification and avoid damage to equipment or process line. The purity of these gases also plays an important role in controlling reactions and reactor performance, avoiding contamination of valuable catalysts, and ensuring the efficiency of the synthesis process and resulting product quality.

## What's your challenge?



The success and profitability of many gas processing industries and applications relies on the accurate and reliable detection and removal of gas impurities in each stage of the reaction process.

## What's your opportunity?



The Rosemount QCL/TDL technology delivers fast and highly accurate identification and analysis of gas impurities in a single analyzer instrument, ensuring reliable process control and lower operating costs.

## Typical H<sub>2</sub> Purity Process

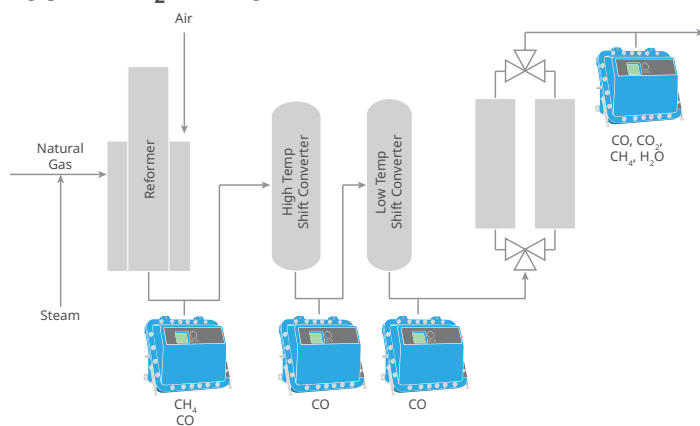

## Measurement Ranges

Component	Measurement Range		
	Range <sup>1</sup>	Units <sup>2</sup>	LOD
CO	0–5	ppm vol	0.05
CO <sub>2</sub>	0–5	ppm vol	0.02
H <sub>2</sub> O	0–20	ppm vol	0.2
CH <sub>4</sub>	0–50	ppm vol	0.2
NH <sub>3</sub>	0–10	ppm vol	0.1

<sup>1</sup> Components and ranges are indicative. Detailed specs will be provided during the ordering process.

<sup>2</sup> Repeatability ±1 percent of reading or the Limit of Detection (LOD), whichever is greater.

## Gain the Process Insights to Ensure Hydrogen / Nitrogen Purity

The use of high-purity hydrogen and nitrogen gases is vital to avoid equipment plugging and damage, ensure proper catalyst integrity and reactions, and achieve improved process performance. Rosemount QCL/TDL lasers deliver real-time monitoring performance using a single analyzer device for increased process efficiency and minimized cost.

- Multiple QCL/TDL lasers in a single analyzer for faster detection and analysis of NH<sub>3</sub>, CO, and CO<sub>2</sub>, methane, and moisture
- Analysis time of <1 second delivers critical gas purity monitoring to ensure the integrity of the process
- High sensitivity and selectivity allow the detection of a variety of components and impurities, even in complex mixtures
- Patented laser chirp technique analyzes the gas stream continuously down to low ppm concentrations, delivering sub-second measurements
- Reduced consumables and calibration requirements minimize cost and maintenance
- Easy-to-install instrumentation and fast technician training simplify operations

## Control Your Process Using Rosemount CT5800 Continuous Gas Analyzer

- Unique cell design delivers highly accurate measurement of low concentrations of impurities in gas streams
- Designed for up to six Quantum Cascade Lasers
- Multi-component and simultaneous measurement in a single gas analyzer
- Ideal for nitrogen stream and hydrogen stream purity applications
- Flameproof enclosure for hazardous area applications



# Specifications

Specifications	CT4400	CT5100	CT5400	CT5800
----------------	--------	--------	--------	--------

For a complete list of product specifications, please refer to the individual product data sheets.

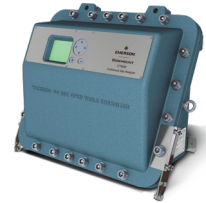
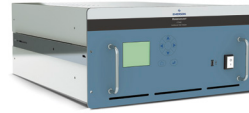

<b>Area Certification</b>	General purpose - safe area analyzer	North America: Class I, Division 2 Groups A, B, C, D, T3 Europe: ATEX II 3G Ex p Group IIC T3	General purpose - safe area analyzer	Europe: ATEX II 2G Ex d IIB+H2 T4 North America: Class I, Division 2, Groups B, C, D, T4
<b>Performance</b>				
Repeatability	±1% of reading	±1% of reading	±1% of reading	±1% of reading
Linearity	R <sup>2</sup> > 0.99	R <sup>2</sup> > 0.999	R <sup>2</sup> > 0.999	R <sup>2</sup> > 0.999
Measurement Rate	1 Hz (up to 10 Hz on request)	1 Hz (up to 10 Hz on request)	1 Hz (up to 10 Hz on request)	1 Hz (up to 10 Hz on request)
<b>Environmental</b>				
Ambient Temperature	41 to 122 °F (5 to 50 °C) ±1% per 5 °C	-4 °F to 131 °F (-20 °C to 55 °C)	32 °F to 113 °F (0 °C to 45 °C)	-4 °F to 131 °F (-20 °C to 55 °C)
Sample Gas Temperature	59 °F to 122 °F (15 °C to 50 °C)	Up to 374 °F (190 °C) factory set	Up to 374 °F (190 °C) factory set	39 °F to 140 °F (4 °C to 60 °C)
Humidity Range	10–95%, Non-condensing	10–95%, non-condensing	10–95%, non-condensing	10–95%, non-condensing
Protection Class	n/a	IP66/NEMA 4X (main enclosure)	n/a	IP66/NEMA 4X
<b>Communications</b>				
Analog Signal Out	4–20 mA (1 per measurement)	4–20 mA (1 per measurement)	4–20 mA (1 per measurement)	4–20 mA (1 per measurement)
Protocols	Modbus® (over Ethernet TCP/IP™)	Modbus (over Ethernet TCP/IP)	Modbus (over Ethernet TCP/IP)	Modbus (over Ethernet TCP/IP)
Inlet Gas Connector	¼ in. and 6 mm Swagelok® type	¼ in. and 6 mm Swagelok type	¼ in. and 6 mm Swagelok type	¼ in. and 6 mm Swagelok type
Outlet Gas Connector	¼ in. and 6 mm Swagelok type	¼ in. and 6 mm Swagelok type	¼ in. and 6 mm Swagelok type	¼ in. and 6 mm Swagelok type
<b>Utilities</b>				
Power Supply	100–240 VAC, 50/60 Hz	110 VAC 60 Hz / 240 VAC 50 Hz	110 VAC 60 Hz / 240 VAC 50 Hz	120 VAC 60 Hz / 240 VAC 50 Hz
<b>Mechanical</b>				
External Dimensions (Nominal)	Half-rack: 8.5 x 24.5 x 6.8-in. (215 x 623 x 172 mm) Full-rack (including handles): 19 x 25.9 x 6.8-in. (482.6 x 658 x 172 mm)	22.68-in. x 11.7-in. x 30.94-in. (575 mm x 298 mm x 786 mm)	19-in. x 26.5-in. x 8.7 in. (482.6 mm x 673 mm x 221.5 mm)	Closed: 27.34-in. x 11.5-in. x 20.28-in. (694.5 mm x 292 mm x 515 mm) Open: 27.34 in. x 11.5 in. x 41.24-in. (694.5 mm x 292 mm x 1047.5 mm) Opening radius: 21.46-in. (545 mm)
Weight	Half-rack: 33.1 lbs. (15 kg) Full-rack: 66.1 lbs. (30 kg)	117 lbs. (53 kg)	68.34 lbs. (31 kg)	176.37 lbs. (80 kg)
Installation	19-in. Rack Mount or Half 19-in. Rack Mount	Wall Mount	19 in. Rack Mount	Wall Mount



# Service and Support

## Engineered Sample Handling Systems

Process gas analyzers are only as good as the quality of the sample they measure. Tested rigorously before shipment, Emerson provides custom engineered sample handling systems designed to meet the application's specifications.

## Lifecycle Services & Support

Our team of trained and certified field experts know and understand the requirements needed to develop a customized service program to suit your application. We provide complete turnkey services to support your operation. From pre-installation services to on-going maintenance and support, we have the expertise to ensure your Rosemount analyzers run at ideal operating conditions during their entire lifecycle.

Field services include, but are not limited to the following:

- Startup and commissioning
- Scheduled maintenance
- On-site support
- Field retrofits
- Training



## Training Services

Whether your goal is to reduce maintenance costs, maximize up-time, or reduce lost and unaccounted for gas running through the pipeline, Emerson offers a complete list of training courses and continuous support programs to ensure your technicians know how to properly operate and maintain the analyzer during its lifecycle.

Our certified instructors offer two types of training courses:

**Standard Training** programs are scheduled periodically throughout the year at one of our four training facilities. Each course varies in length, typically lasting between four to eight hours a day for a period of four days, depending on the course level and student knowledge and experience. These classes are designed to expand a student's knowledge, covering such topics as how to properly configure the instruments to meet the plant's monitoring and control needs, how to properly calibrate and care for them, and how to use diagnostic variables to troubleshoot problems and schedule routine maintenance.

**Private Training** classes can also be arranged at an off-site location depending on availability and training location requested. Training is conducted in both a formal classroom setting and a hands-on instructional approach to give customers a complete training program customized to their specific needs and interests.

All standard and private training courses are taught by Emerson certified instructors who work with each student to provide the necessary hands-on training, theory, and conceptual knowledge needed to perform on-the-job functions safely and accurately.

The instructor will prepare a course curriculum designed around the student's skill level and expertise, often covering everything from installation and startup, all the way through commissioning and long-term maintenance within the same class. For the more experienced student, advanced training courses are available. Typical students who attend our training program include plant personnel, analytical technicians, and field service engineers.

# Hybrid QCL/TDL Laser Analyzers. Fast, high-resolution gas sensing for real-time insights into your process.



Rosemount CT5100

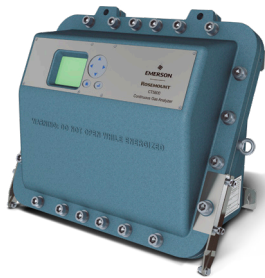

Rosemount CT5800



Rosemount CT4400



Rosemount CT5400

Control and optimize your process and ensure reliable emissions monitoring with highly sensitive and selective gas analysis.



The Emerson logo is a trademark and service mark of Emerson Electric Co.  
Rosemount is a registered trademark of one of the Emerson family of companies.  
All other marks are the property of their respective owners.  
© 2024 Emerson Electric Co. All rights reserved.

00803-0100-4511 Rev AD

