A photograph of industrial machinery in a factory setting. A cardboard box is suspended in the center of the frame, held by a mechanical assembly. The machinery is primarily blue and silver, with various pipes, hoses, and electrical components. A prominent feature is a vertical stack of three lights: red at the top, yellow in the middle, and green at the bottom. The background is a plain, light-colored wall. A dark blue banner is overlaid on the left side of the image, containing white text.

**Eliminate power interruptions,  
transients and noise that stop  
production and corrupt data.**

## **SolaHD™ Surge Protective Devices (SPD) and Filtering — Product Guide**

Delivering required voltages safely and efficiently, to applications across manufacturing facilities.



## How do you protect your power?



Employing an entire facility protection strategy will safeguard the electrical system against most transients. Multi-stage protection involves clamping the initial high-energy surge, filtering any remaining noise or transients to the protected sensitive equipment and finally, protecting the data/signal lines entering or leaving the control panel or the factory floor. This coordination of devices provides the lowest possible let through voltage to the equipment.

Emerson understands that your operations depend on clean, continuous power. That is why, since 1915, our SolaHD brand of power quality products has focused exclusively on providing the best solutions to eliminate power interruptions, transients and noise that can stop production and corrupt data. Our full breadth of products convert, clean and maintain electric current from the factory entrance to equipment throughout your facility. Combined with service and support, our total power quality offering can save you time, money and space to ensure optimal production efficiencies.



Surge Protection, the first line of defense in protecting your production line and facility.

### Product Overview

- SPD & STV Series ▶ p 6
- STFV Series ▶ p 7
- STC Series ▶ p 8

### Surge Protective Device/Filter - Application Selection Table

- Surge Protective Device/Filter ▶ p 9

### UL 1449 and IEEE

- UL 1449 and IEEE- ▶ p 10

### Surge Protection

- SPD200/300K Series ▶ p 11
- STV100K Series ▶ p 14
- SPD50K Series ▶ p 17
- STV25K DIN Rail Mount Series ▶ p 18

### SolaHD Tracking Filtering with Surge Protection

- STFV Plus Series SolaHD Tracking Filters with Surge Protection (Chassis Mount) ▶ p 20
- STFE Elite Series SolaHD Tracking Filters with Surge Protection (DIN Mount) ▶ p 23

### Specialty & Data/Signal Line Surge Protection

- STC Series of Data/Signal Line Surge Protection ▶ p 25
- STG-POE ▶ p 26
- STG-DRS ▶ p 28
- STG-642 ▶ p 29

### Specialty Surge & Filter

- STG-SLAC ▶ p 30
- STG-SS ▶ p 31

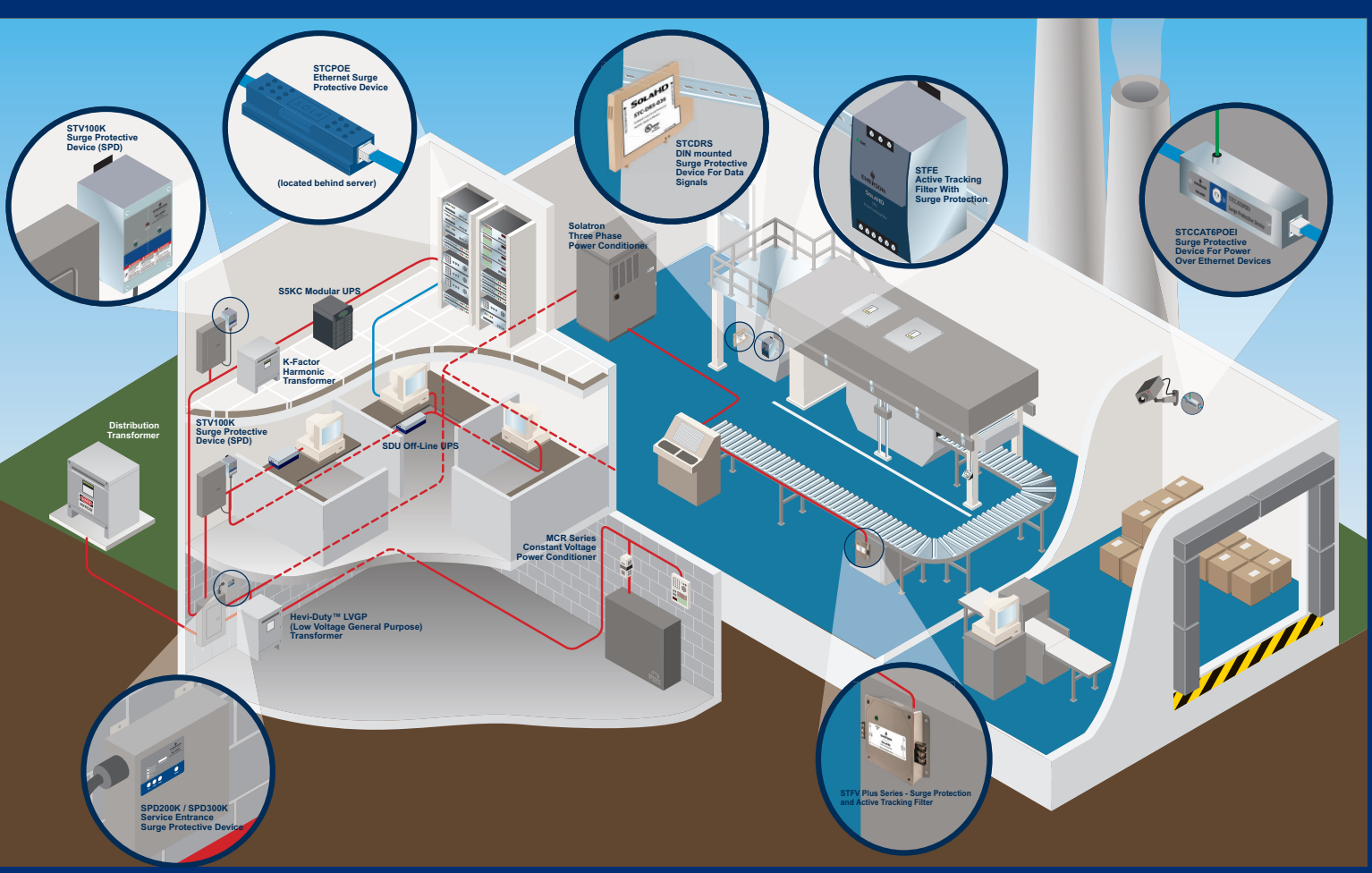

**A SPD200K AND SPD300K**

Surge protective devices designed for severe exposure locations. They are capable of handling the high-impulse, potentially damaging transients commonly found at the service entrance or distribution panels.

**B STV100K**

Surge protective devices designed for medium exposure locations. They are capable of protecting sensitive equipment and microprocessor-based systems from transients on distribution and sub-distribution panels.

**C STCPOE**

Surge protective devices designed to work on Category 5 Power-over-Ethernet (POE) transmission lines as well as Category 6 applications.

**D STCDRS**

DIN Rail mountable, single pair, surge protective device featuring three stage hybrid technology designed to mollify low-voltage data line surges.

**E STFE**

DIN Rail mounted device that combines sinewave tracking technology with surge protection to attenuate or reduce the amplitude of normal mode noise to a minimum.

**F STCCAT6POEI**

Premium surge protective device tailored to protect Power Over Ethernet devices like security cameras.

**G STFV**

DIN Rail mounted device that combines sinewave tracking technology with surge protection to protect against the full spectrum of voltage transients and surges. Designed to continuously track AC power input and respond to high-voltage transients and high-frequency noise.

# Longer lifespans, low maintenance and ratings that exceed industry standards.

In the automotive, material handling, packaging, and oil and gas industries, clean, reliable power is essential to keeping facilities and plants running smoothly. Anywhere there is an on/off switch, you can have a transient. In today's modern facilities, more and more sensitive equipment can be found on the floor – from production, computing, networking and telecommunications – and they all need to stay up and running. By protecting electronic equipment from surges and noise, the life expectancy can be greatly increased.

## Improve Machine Availability



Surge protective devices focus on limiting high-voltage spikes, to a level that is acceptable to most electronic equipment. This is a first line of defense, using components that are placed in parallel with the line and serve as a clamping mechanism for high-energy impulses. SolaHD Surge Protective Devices by Emerson are typically installed at service entrances and on larger distribution panels, but can be installed on critical panels.

"The effects of power outages on business: 98 percent of organizations say one hour of downtime costs over \$100,000."

—Source: Foster Fuels. The Effects Of A Power Outage On A Business. February 08, 2018. <https://www.fosterfuelsmissioncritical.com/power-outage-effects-businesses/>

## Increase Reliability



Changing technology and dependence on total automation processes within modern facilities has created a critical need for clean AC power at the equipment level. Low-energy transients and high-frequency noise are the primary causes for system disruption and long-term degradation of microprocessor-based equipment within facilities. SolaHD Tracking Filters by Emerson are an ideal solution for your microprocessor-based products, including industrial PLCs, OEM applications and motion control systems.

"Power surges can cause failure, permanent degradation, or temporary malfunction of electronic devices and systems. The development of an effective SPD is of paramount importance to manufacturers and users of industrial electronic equipment."

—Source: IEEE. Electrical Surge-Protection Devices for Industrial Facilities— A Tutorial Review. February 2007. [https://enervisor.com/document\\_upload/SurgeSuppressionTutorial.pdf](https://enervisor.com/document_upload/SurgeSuppressionTutorial.pdf)

## Added Flexibility



The need to protect all susceptible low-voltage cable routes entering a facility and at key points within the building is as critical as protecting the equipment from high-energy impulses. Your facility's reliance on sensitive instrumentation, networked automation, and uncorrupted data transmission increases. SolaHD Data/Signal Line products by Emerson utilize high-speed, high-energy components that come in a variety of unique packaging configurations to protect your point of use equipment.

"Typical applications of surge protective devices within industrial or commercial settings include HVAC systems, generators, security systems and cameras, and fire alarm signaling circuits. A recent survey found that all facilities that experienced power surges have reported downtime. The average cost of downtime due to a surge is \$130,000 per event."

—Source: ESFi. ESFi Addresses The Importance of Surge Protective Devices for Your Facility. November 30, 2020. <https://www.esfi.org/news/esfi-addresses-the-importance-of-surge-protective-devices-for-your-facility-786#sthash.OglylA0h.dpbs>



Visit [www.solahd.com](http://www.solahd.com) or contact your local SolaHD representative to learn more about our Control Power solutions.

# Surge Protection: First Line of Defense in Limiting High-Impulse Transients



High-energy transients, either externally or internally generated, pose an immediate threat to the reliability and performance of your sensitive electronic equipment. Emerson recommends placing high-energy SolaHD Surge Protective Devices (SPDs) on key panels throughout your facility. Within your facility, motors, inductive loads and various equipment load switching can cause damage or costly downtime.

Our SolaHD surge protective devices focus on limiting high-voltage spikes to a level that is acceptable to most electronic equipment. Plus, they are a great first line of defense, using components that are placed in parallel with the line and serve as clamping mechanisms for high-energy impulses. Protection at this level is referred to in the industry as Sine Wave Tracking or electronic grade. Surge Protective Devices are typically installed at service entrance, distribution panels, critical branch panels and key point-of-use locations.

Service Entrance/ Distribution Panels	Branch Distribution	Point of Use Locations
<b>SPD200K/300K</b>	<b>STV100K</b>	<b>SPD50K/STV25K</b>
Typical applications of 800 amperes and above	Typical applications up to 800 amperes, electrical distribution system	Typical applications of 100 amperes and below
Surge current capacity – 300,000 and 200,000 Amps per phase	Surge current capacity – 100,000 Amps per phase	Surge current capacity – 50,000 and 25,000 Amps per phase

# SolaHD Tracking Filtering with Surge Protection: Provides Clean AC Power by Eliminating Low-Voltage Noise



Low-energy transients and high-frequency noise are the primary causes for system disruption and long-term degradation of microprocessor-based equipment within your facility. For more than 50 years, SolaHD Tracking Filters by Emerson have proven to be the most effective solution in critical equipment protection within harsh industrial environments. SolaHD Tracking Filters are built upon a unique multi-stage hybrid design. This design creates a foundation for a family of products that attenuate impulses that would normally go untouched by standard, parallel clamping devices.

Changing technology and dependence on total automation processes within modern facilities create a critical need for clean AC power at the equipment level. Our SolaHD Tracking Filters are a perfect solution for your microprocessor-based products, including industrial PLCs, OEM applications and motion control systems.

STFE Elite Series	STFV Series
DIN Rail mount	Hard-wired connection
Critical single phase loads up to 20 amperes of continuous current	Critical single phase loads up to 30 amperes of continuous current

## Data/Signal Line Surge Protection: Designed to Protect Sensitive Instrumentation



The rapid development of automated controls, telecommunications and fire/alarm/security systems make it imperative to have properly coordinated low-voltage surge protection. Modern networked industrial facilities require error-free transmission of information for maximum productivity and integrity of data, but these areas are often overlooked when it comes to power protection.

The need to protect all susceptible low-voltage cable routes entering a facility and at key points within the building is as critical as protecting the equipment from high-energy impulses. The importance of protection at this level grows as a facility's reliance on sensitive instrumentation, networked automation, and uncorrupted data transmission increases. SolahD Data/Signal Line products by Emerson utilize high-speed, high-energy components that come in a variety of voltage levels and unique packaging configurations.

STC Series
Three stage hybrid protection
<1 nanosecond response times
Variety of voltage and packaging configurations



# Surge Protective Device/Filter Application Selection Table

Applications	Surge Protection				SolaHD Tracking Filtering With Surge Protection		Data/Signal
	SPD200K/300K	STV100K	SPD50K	STV25K	STFE	STFV	STC
Facility Service Entrance	●						
Distribution Panels	●	●					
Sub-Distribution Panels		●					
Branch Panelboards (Commercial)		●	●				
Branch Panelboards (Residential)		●	●				
Motor Control Centers		●	●	●			
Programmable Logic Controllers			●	●	●	●	
Control Panels (AC Power)			●	●	●	●	
Various OEM Equipment					●	●	
PoE (Power-over-Ethernet)							●
Industrial Communications							●
Programmable Logic Controllers (I/O Circuits)							●
Control Panels (Low-Voltage)							●
Water/Wastewater Instrumentation							●



Visit [www.solahd.com](http://www.solahd.com) or contact your local SolaHD representative to learn more about our Control Power solutions.

# UL 1449 and IEEE

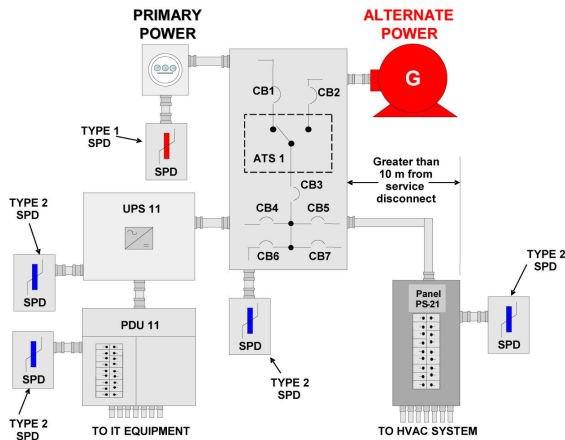

SPD Locations by UL 1449 Types

Underwriters Laboratories, UL 1449, is the Safety Standard for Surge Protective Devices. It is used to evaluate these types of products.

UL categorizes surge protective devices (SPD) into categories based on their intended application.

SPD Locations by UL 1449 Types:

- TYPE 1 - Connect anywhere in the customer’s facility – we strongly urge this to be specified for all critical installations.
- TYPE 2 - Connect downstream on load side of main breaker. Be aware that some competitors may have “conditions of acceptability” that can limit how the device is installed.
- TYPE 3 - Typically cord connected, plug in devices.
- TYPE 4 - Assembly tested to type 1 or type 2.
- TYPE 5 - Component level device.

Nominal Discharge Current (I Nominal Rating):

This is the peak value of surge current which goes through the SPD during the test.

- TYPE 1 - UL tests to 10 kA or 20 kA. Not to be confused with maximum kA rating of the device. We recommend 20 kA I Nominal rating be specified. While this is the highest UL rating, it is a low level surge which should be required by any device in even moderate exposure installations.
- TYPE 2 - UL tests to 3 kA, 5 kA, 10 kA or 20 kA I Nominal ratings. Again, 20 kA is recommended for all specified SPD located at service entrances.

Voltage Protection Rating (VPR):

- These ratings replace the Suppressed Voltage Ratings (SVR) of the second edition standard. UL uses a surge six times the current level of the SVR testing (3,000 Amps vs. 500 Amps), so ALL measured VPR ratings are higher than the previous SVR rating.

All facilities that employ mission-critical electronic equipment should have properly sized surge protective devices (SPD) installed at the main electrical service entrance and throughout their facility at the distribution and branch levels. The surge protection connected to the incoming power line provides the first line of defense against transient surges which are typically caused by nearby utility grid switching, lightning or other power disturbances. However, disturbances can be internally generated as well as externally generated so employing SPDs at key panels throughout your facility will also provide suitable downstream protection from external surges and local protection from internal high-energy transients caused by motors, inductive loads, and various equipment load switching that can also cause damage or costly downtime.

IEEE Standard 1100-2005, The Emerald Book:

- IEEE Recommended Practice for Powering and Grounding Electronic Equipment recommends a tiered SPD protection from your Service Entrance down to branch panel level.
- 7.2.4 Surge suppressors: “...Effective surge protection for an entire building power distribution system requires the coordinated use of large-capacity current-diverting devices at the service entrance followed by lower capacity voltage-clamping devices applied strategically throughout the power system.”

# SPD200K and SPD300K Series



SPD200K and SPD300K shown with Internal View

## Applications

- Service Entrance and Distribution Panels
- Branch, Lighting and Control Panels
- Factory Automation Installations
- Dedicated Industrial Equipment

## Features

- Surge current capacity of 200 and 300 kA per phase
- Metal, UL Listed /NEMA type 1/12/3R/4 enclosure standard
- UL 1449, Type 2, 20 kA I-nominal approved device
- Complies with UL 96A 12th Edition master label requirements for lighting protection systems
- 200 kA SCCR
- All modes transient protection (L-N, L-G, L-L, and N-G)
- Form C dry contacts, audible alarm status indication and counter standard
- Internal rotary disconnect standard
- External monitoring, including neutral to ground
- UL1283 EMI/RFI Filtering standard
- Ten year limited warranty

The SPD200K and SPD300K Series offers continuous protection from damaging voltage transients and electrical noise commonly found at the service entrance or distribution panel. The design of the SPD200K and SPD300K allows for installation flexibility and the robust design allows for installation in the most severe exposure locations. They are capable of handling the high-impulse, potentially damaging transients commonly found at the service entrance or distribution panels.

The SPD200K and SPD300K utilizes circuitry to monitor the status of all protection modes, including neutral to ground. Should protection be unavailable in any mode, the Green LED will be extinguished, and the Red LED will be illuminated. In addition, high isolation form C dry contacts provide remote monitoring of protection system failure, under voltage, phase and power loss. The SPD200K and SPD300K protection integrity monitoring indicates failure for both shorted or opened protection components.

These devices are built to meet your unique requirements, and are available in hardwire, three phase configuration with an internal rotary disconnect standard. They are designed for years of trouble free operation and require little or no operator intervention after installation.

# SPD200K and SPD300K Series

## Selection Table

Catalog Number	Input Voltage	
SPD200K10YRC	208Y/120 V	Three Phase Wye, 4-Wire + Ground
SPD200K24DRC	240D V	Three Phase Delta, 3-Wire + Ground and HRG Wye
SPD200K27YRC	480Y/277 V	Three Phase Wye, 4-Wire + Ground
SPD200K34YRC	600Y/347 V	Three Phase Wye, 4-Wire + Ground
SPD200K48DRC	480D V	Three Phase Delta, 3-Wire + Ground and HRG Wye
SPD200K60DRC	600D V	Three Phase Delta, 3-Wire + Ground and HRG Wye
SPD300K10YRC	120/208 V	Three Phase Wye, 4-Wire + Ground
SPD300K24DRC	240D V	Three Phase Delta, 3-Wire + Ground and HRG Wye
SPD300K27YRC	480Y/277 V	Three Phase Wye, 4-Wire + Ground
SPD300K34YRC	600Y/347 V	Three Phase Wye, 4-Wire + Ground
SPD300K48DRC	480D V	Three Phase Delta, 3-Wire + Ground and HRG Wye

## Dimensional Specifications

Catalog Number	Dimensions D x W x H mm (in.)	Suggested Breaker Size	Suggested Wire Size (AWG)	Weight lbs (kg)	Allowable Breaker Range	Allowable Wire Range
SPD200K	152.4 x 304.8 x 304.8 (6.0 x 12.0 x 12.0)	40 A	#8	23 (10.4)	40–100 A	#8–1/0
SPD300K	152.4 x 304.8 x 304.8 (6.0 x 12.0 x 12.0)	40 A	#8	24 (11.79)	40–100 A	#8–1/0

# SPD200K and SPD300K Series

## Specifications

Catalog Number	SPD200K10YRC	SPD200K24DRC	SPD200K27YRC	SPD200K48DRC	SPD200K34YRC	SPD200K60DRC
Input Voltage	208Y/120 V	240D V	480Y/277 V	480D V	600Y/347 V	600D V
	3Ph Wye, 4 W + G	3Ph Delta, 3 W + G and HRG Wye	3Ph Wye, 4 W + G	3Ph Delta, 3 W + G and HRG Wye	3Ph Wye, 4 W + G	3Ph Delta, 3 W + G and HRG Wye
Maximum Continuous Operating Voltage (MCOV)	125% of the nominal level for 120 V; 115% for all other voltages					
Line Frequency	47–63 Hz					
Response Time	< 0.5 nanoseconds					
Enclosure	Metal, UL Listed /NEMA type 1/12/3R/4					
Mounting Type	Wall Mounted (mounting hardware ¼ in.)					
Connection	Internal Rotary Disconnect					
Status Indication	Red and green LED status indicators, audible alarm, summary alarm contacts, counter					
Operating Temperature	-40 °C to +60 °C (-40 °F to +140 °F)					
Operating Humidity	0% to 95% non-condensing					
Noise Attenuation	50 dB from 10 kHz to 100 MHz					
Modes of Protection	All Modes: L–N, L–L, L–G, N–G ①					
SCCR Rating	200 kAIC					
Nominal Discharge Current Rating (In)	20 kA					
Warranty	10 year limited warranty					

Catalog Number	SPD300K10YRC	SPD300K24DRC	SPD300K27YRC	SPD300K48DRC	SPD300K34YRC
Input Voltage	120/208 V	240D V	480Y/277 V	480D V	600Y/347 V
	3Ph Wye, 4 W + G	3Ph Delta, 3 W + G and HRG Wye	3Ph Wye, 4 W + G	3Ph Delta, 3 W + G and HRG Wye	3Ph Wye, 4 W + G
Maximum Continuous Operating Voltage (MCOV)	125% of the nominal level for 120 V; 115% for all other voltages				
Line Frequency	47–63 Hz				
Response Time	< 0.5 nanoseconds				
Enclosure	Metal, UL Listed /NEMA type 1/12/3R/4				
Mounting Type	Wall Mounted (mounting hardware ¼ in.)				
Connection	Internal Rotary Disconnect				
Status Indication	Red and green LED status indicators, audible alarm, summary alarm contacts, counter				
Operating Temperature	-40 °C to +60 °C (-40 °F to +140 °F)				
Operating Humidity	0% to 95% non-condensing				
Noise Attenuation	-50 dB from 10 kHz to 100 MHz				
Modes of Protection	All Modes: L–N, L–L, L–G, N–G ①				
SCCR Rating	200 kAIC				
Nominal Discharge Current Rating (In)	20 kA				
Warranty	10 year limited warranty				

① Delta Model does not offer L-N or N-G mode of protection

# STV100K Series



## Applications

- Distribution Panels (up to 800 A)
- Branch, Lighting and Control Panels
- Factory Automation Installations
- Dedicated Industrial Equipment

## Features

- 100,000 Amps peak current rating provides all mode protection against severe transients
- UL 1449, Type 2, 20 kA I-nominal approved device
- Low clamping levels for more effective protection
- 100 kAIC fault current fusing level provides safety and NEC conformance
- LED status, audible alarms and form C dry contacts
- Compact, rugged metal
- Ten year limited warranty

The STV100K Series hardwired surge protective devices are designed for installation at the service entrance, branch panel or a dedicated sensitive electronic load. These units feature all mode protection, LED and audible alarm status indication, sinewave tracking and form C dry contacts. The STV100K Series also contains the highest levels of safety built into the product including thermal fusing and a fault current fusing level of 100 kAIC.

## Selection Table

Catalog Number	Input Voltage	
STV100K10S	120/240 V	Split Phase, 3-Wire + Ground
STV100K10Y	208Y/120 V	Three Phase Wye, 4-Wire + Ground
STV100K10N	120 V	Single Phase, 2-Wire + Ground
STV100K24L	240 V	Single Phase, 2-Wire + Ground
STV100K23Y	230Y/400 V	Three Phase Wye, 4-Wire + Ground
STV100K27Y	480Y/277 V	Three Phase Wye, 4-Wire + Ground
STV100K24D	240 V	Three Phase Delta, 3-Wire + Ground
STV100K48D	480 V	Three Phase Delta, 3-Wire + Ground
STV100K10D4	240/120 CT	Three Phase Delta, 4-Wire + Ground (High Leg Delta)
STV100K24D4	480/240 CT	Three Phase Delta, 4-Wire + Ground (High Leg Delta)

# STV100K Series

## Specifications

Catalog Number	STV100K10S	STV100K10N	STV100K24L	STV100K10Y	STV100K23Y
Nominal Input Vac	120/240 V	120 V	240 V	208Y/120 V	400Y/230 V
System Configuration	1Ph, 3 W + G	1Ph, 2 W + G		3Ph Wye, 4 W + G	
Maximum Continuous Operating Voltage (MCOV)	125% of the nominal level for 120 V; 115% for all other voltages				
Line Frequency	47-63 Hz				
Response Time	< 0.5 nanoseconds				
SCCR Rating	100 kAIC				
Fusing	Thermal and Fault Current				
Nominal Discharge Current Rating	20 kA				
Modes of Protection	All Mode: L - N, L - L, L - G, N - G				
Operating Temperature	-40 °C to +60 °C (-40 °F to +140 °F)				
Operating Humidity	0% to 95% Non-condensing				
Noise Attenuation	40 dB maximum				
Dimensions W x D x H mm (in)	152.4 x 101.6 x 81.3 (6.00 x 4.00 x 3.20)				
Net Weight (kg) lbs	3.63 (8.0) maximum				
Enclosure	Metal, UL Listed/NEMA Type 12 Enclosure				
Connection/Mounting Type	Parallel/Flange				
Status Indication	Red and green LED status indicators, audible alarm, Form C contacts				
Warranty	10 year limited warranty				

# STV100K Series

## Specifications

Catalog Number	STV100K27Y	STV100K24D	STV100K48D	STV100K10D4	STV100K24D4
Nominal Input Vac	480Y/277 V	240 V	480 V	240 D/120 V	480 D/240 V
System Configuration	3Ph Wye, 4 W + G	3Ph Delta, 3 W + G		3Ph Delta High Leg, 4 W + G	
Maximum Continuous Operating Voltage (MCOV)	125% of the nominal level for 120 V; 115% for all other voltages				
Line Frequency	47-63 Hz				
Response Time	< 0.5 nanoseconds				
SCCR Rating	100 kAIC				
Fusing	Thermal and Fault Current				
Nominal Discharge Current Rating	20 kA				
Modes of Protection	All Mode: L - N, L - L, L - G, N - G				
Operating Temperature	-40 °C to +60 °C (-40 °F to +140 °F)				
Operating Humidity	0% to 95% Non-condensing				
Noise Attenuation	40 dB maximum				
Dimensions W x D x H mm (in)	152.4 x 101.6 x 81.3 (6.00 x 4.00 x 3.20)				
Net Weight (kg) lbs	3.63 (8.0) maximum				
Enclosure	Metal, UL Listed/NEMA Type 12 Enclosure				
Connection/ Mounting Type	Parallel/Flange				
Status Indication	Red and green LED status indicators, audible alarm, Form C contacts				
Warranty	10 year limited warranty				



# SPD50K Series



## Applications

- Can be installed anywhere in any electrical distribution system; line-side or load-side of main disconnect

## Features

- 50 kA per phase surge current rating
- Type 1: UL 1449, CSA 22.2 No. 269.1
- 200 kA SCCR
- Complies with UL 96A 12th Edition master label requirements for lightning protection systems
- Voltage specific design
- Tri-mount installation possible via standard 0.75 in. nipple, DIN-Rail mount (rail not included) or bracket mount for flat surfaces
- Visual diagnostics
- Dry contact connection leads exit through nipple via #18 AWG (3 feet) at 24 Vdc @ 2 Amps
- Ten year limited warranty

The SPD50K Series offers easily monitored protection from surges. The visual diagnostic system that is featured in the SPD50K is easy to see and easy to diagnose. When the Green LED is visible, the protective device is okay and working correctly. When the Green LED is extinguished an audible alarm will sound. The equipment should be replaced. The LED is visible from multiple sides and angles to allow for better viewing of the status from any of the tri-mount options.

## Specifications

Performance Specifications	
<b>50 kA per Phase Surge Current Rating</b>	
<b>UL 1449 Tested Inominal</b>	20 kA
<b>UL 1449 Tested SCCR</b>	200 kA
<b>Individually fused &amp; Thermally Protected MOVs</b>	
<b>Repetitive Impulse</b>	5000 - 3 kA - 8x20 $\mu$ s; 1000 - 10 kA - 8x20 $\mu$ s
Physical Specifications	
<b>Relative Humidity Range</b>	0-95% non-condensing
<b>Operating Frequency</b>	47-63 Hz
<b>Typical Operating Temperature</b>	-40 °C (-40 °F) to +85 °C (185 °F)
<b>Response Time</b>	<1 nanosecond
<b>Solid State Bi-directional Operation</b>	
<b>NEMA 4X Polycarbonate Enclosure</b>	UL 94V-0
<b>Pre-wired with 3 feet (.9 meter) of #10 AWG Conductor</b>	
<b>Typical Connection</b>	30 A Breaker

# STV25K DIN Rail Series



The STV25K DIN Rail Series provides point-of-use protection, at the dedicated equipment level, against damaging transients. Ideal for installation in electronic control cabinets found in harsh industrial environments such as the factory floor or at remote locations. These devices provide 25,000 Amps of surge protection per phase, sine wave tracking, LED status indication and form C dry contacts. This DIN Rail series also provides protection on all electrical paths and comes with a standard ten year product warranty. The STV25K surge protective devices are UL recognized to Standard 1449.

## Applications (20 Amp Max)

- Control Cabinets for Industrial Automation
- Point-of-Use Industrial/Service Equipment
- Remote Commercial or Industrial Equipment
- Instrumentation and Large Test Equipment
- Commercial and Building Automation Systems

## Features

- Compact and narrow design maximizes panel space
- Low clamping levels for more effective protection
- Easy access terminal screws for quick mounting and installation
- 25,000 Amps of surge protection per phase
- Sine wave tracking and all-mode protection provide consistent and reliable protection on all electrical paths
- Thermal fusing prevents MOV overheating caused by excessive current levels
- Ten year limited warranty

# STV25K DIN Rail Series

## Selection Table

Catalog Number	Input Voltage	
STV25K10S	120 V	Single Phase (L - N)
STV25K24S	240 V	Single Phase (L1 - L2)

## Specifications

Description	STV25K10S	STV25K24S
Input Voltage	120 Vac, 0-135 Vrms	240 Vac, 0-260 Vrms
Maximum Continuous Operating Voltage (MCOV)	150 Vrms	300 Vrms
Line Frequency	47-63 Hz	
Connection/Mounting Type	DIN Rail Mount with screw terminals for #12 AWG	
Input Current Rating	20 Amps	
Phase Configuration	1Ph, 2 W + G	
Short Circuit Current Rating (SCCR)	5 kA	
Weight - kg (lbs)	1.36 (3.0)	
Dimensions H x W x D - mm (in)	123.7 x 65.0 x 120.7 ( 4.87 x 2.56 x 4.75) Includes mounting bracket	
Modes of Protection	All Mode: L - N, L - L, L - G, N-G	
Status Indication	Green LED, Form C Contacts	
Packaging	Metal DIN Rail Mount Enclosure, IP20	
Response Time	< 0.5 nanoseconds	
Operating Temperature	-40 °C to +60 °C (-40 °F to +140 °F)	
Operating Humidity	0% to 95% Non-condensing	

# STFV Plus Series



## Applications

- Branch and Control Panels
- Factory Automation Installations
- Point of Use Industrial Service Equipment
- Programmable Logic Controllers
- Dedicated Industrial and Machine Tools
- Telecommunications and IT Equipment

## Features

- Series filter/SPD technology for total durability
- High impact plastic case, epoxy encapsulated enclosure
- Transient protection in all modes (L-N, L-G, and N-G)
- Single phase applications up to 30 Amps
- Operating temperature from -40 °C to +60 °C (-40 °F to +140 °F)
- Hardwired connection
- LED power indication
- Ten year limited warranty

The STFV Plus Series combines SolahD Tracking filtration for low-energy noise and surge protection for high-energy transients. It continuously tracks the input AC power line responding instantly into action upon detecting extraneous high-frequency noise and high-voltage transients caused by everyday events such as turning on machinery, motors or equipment.

These devices are designed to meet UL 1283 for Electromagnetic Interference Filters. STFV Plus attenuates or reduces the amplitude of high-frequency noise to a maximum of -90 dB that occurs in a range of 100 kHz to 50 MHz. STFV Plus provides the industry's best IEEE C62.41 Category A and B Ringwave protection.

They are designed for years of trouble free operation and require little or no operator intervention after installation.

SolahD Tracking Filter is one part of a total power quality solution. They can be used alone or in conjunction with other SolahD products to solve more complex power quality problems.

## System Design

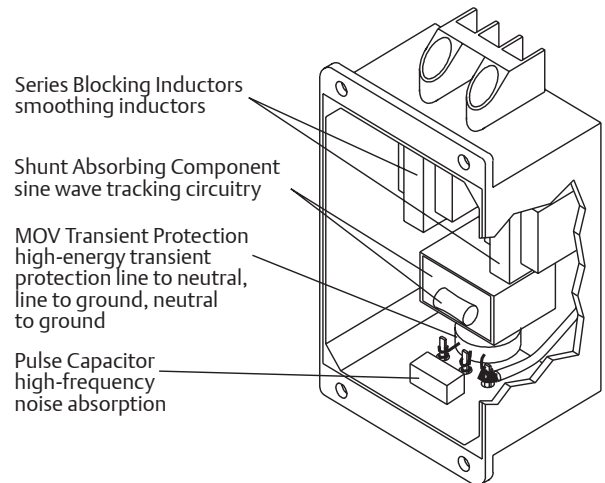

# STFV Plus Series

## Selection Table

Catalog Number	Amps	Case Dim. mm (in) - A x B x C	Mounting Flange Dim. mm (in) - D x E x F x G	Number Min. Wire Size (AWG Suggested)	Screw Size	Fuse/Circuit Breaker Ampacity		Weight lbs (kg)	ICxxx Equivalent
						Suggest	Max		
<b>Single Phase Models (120 Vac)</b>									
STFV02510N	2.5	101.6 x 73.2 x 46.0 (4.00 x 2.88 x 1.81)	111.3 x 53.8 x 134.9 x 4.8 (4.38 x 2.12 x 5.31 x 0.19)	26	#6	2.5	3.125	.45 (1.0)	IC102
STFV05010N	5.0	101.6 x 73.2 x 46.0 (4.00 x 2.88 x 1.81)	111.3 x 53.8 x 134.9 x 4.8 (4.38 x 2.12 x 5.31 x 0.19)	22	#6	5	6.25	.59 (1.3)	IC105
STFV07510N	7.5	120.7 x 120.7 x 59.7 (4.75 x 4.75 x 2.35)	133.4 x 88.9 x 158.8 x 4.8 (5.25 x 3.50 x 6.25 x 0.19)	18	#6	7.5	6.25	.91 (2.0)	IC107
STFV15010N	15.0	158.8 x 120.7 x 59.7 (6.25 x 4.75 x 2.35)	171.5 x 88.9 x 196.9 x 4.8 (6.75 x 3.50 x 7.75 x 0.19)	14	#8	15	18.75	1.59 (3.5)	IC115
STFV30010N	30.0	196.9 x 120.7 x 59.7 (7.75 x 4.75 x 2.35)	209.6 x 88.9 x 228.6 x 4.8 (8.25 x 3.50 x 9.00 x 0.19)	10	#8	30	37.5	2.72 (6.0)	IC130
<b>Single Phase Models (240 Vac)</b>									
STFV02524L	2.5	101.6 x 73.2 x 46.0 (4.00 x 2.88 x 1.81)	111.3 x 53.8 x 134.9 x 4.8 (4.38 x 2.12 x 5.31 x 0.19)	26	#6	2.5	3.125	.59 (1.3)	IC202
STFV05024L	5.0	120.7 x 120.7 x 59.7 (4.75 x 4.75 x 2.35)	133.4 x 88.9 x 158.8 x 4.8 (5.25 x 3.50 x 6.25 x 0.19)	22	#6	5	6.25	.91 (2.0)	IC205
STFV07524L	7.5	158.8 x 120.7 x 59.7 (6.25 x 4.75 x 2.35)	171.5 x 88.9 x 196.9 x 4.8 (6.75 x 3.50 x 7.75 x 0.19)	18	#6	7.5	9.375	1.59 (3.5)	IC207
STFV15024L	15.0	196.9 x 120.7 x 59.7 (7.75 x 4.75 x 2.35)	209.6 x 88.9 x 228.6 x 4.8 (8.25 x 3.50 x 9.00 x 0.19)	14	#8	15	18.75	2.63 (5.8)	IC215
STFV30024L	30.0	196.9 x 120.7 x 59.7 (7.75 x 4.75 x 2.35)	209.6 x 88.9 x 228.6 x 4.8 (8.25 x 3.50 x 9.00 x 0.19)	10	#8	30	37.5	2.72 (6.0)	IC230

# STFV Plus Series

## Specifications

Description	Value	
Input Voltage	120 Vac Models	0-150 Vrms
	240 Vac Models	0-275 Vrms
Line Frequency	50/60 Hz	
Configuration	1Ph (2 W + G)	
Response Time	< 5 nanoseconds	
Enclosure	High impact plastic case, 94 V-0, Vacuum impregnated magnetics, epoxy encapsulated	
Fusing	External	
Status Indication	Green LED	
Connection/Mounting Type	Series/Panel Mount	
Operating Temperature	-40 °C to +60 °C (-40 °F to +140 °F) at full load Derate Linearly to 60% at +70 °C (+158 °F)	
Operating Humidity	0% to 95% Non-condensing	
Mean Time Between Failure (MTBF)	Greater than 100,000 hours (Mil. Std. 217F)	
Packaging	High impact plastic case, vacuum impregnated magnetics, epoxy encapsulated	
Peak Surge Current Capability (8x20 $\mu$ s)	Per Phase	13,000 Amps
	Line to Neutral	6,500 Amps
	Line to Ground	6,500 Amps
	Neutral to Ground	6,500 Amps
Load Surge Current Rating	10 milliseconds	5 x Nominal
	1 second	3 x Nominal
	10 seconds	2 x Nominal
Frequency Response (Forward Reverse)	100 kHz to 50 MHz	-90 dB maximum
Transient Reduction (IEEE C62.41)	Typical Category A Ringwave (6 kV, 200 A, 100 kHz)	< 10 Volts peak
	Typical Category B Ringwave (6 kV, 500 A, 100 kHz)	< 50 Volts peak
Warranty	10 year limited warranty	

# STFE ELITE Series

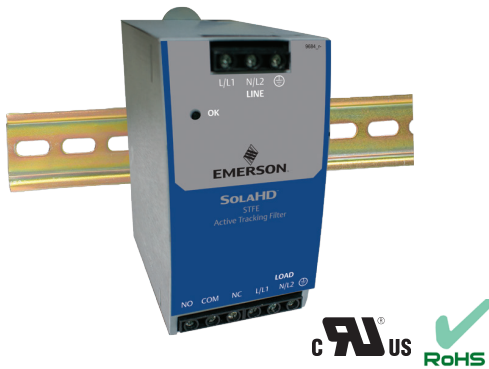

## Applications

- Control Panels
- Factory Automation Installations
- Point of Use Industrial Equipment
- Programmable Logic Controllers
- Dedicated Industrial and Machine Tools Equipment

## Features

- Series connected DIN Rail mounted filter
- Durable metal mount clip
- Transient protection in all modes (L-N, L-G, and N-G)
- Single phase applications up to 20 Amps
- Operating temperature from -40 °C to +50 °C (-40 °F to +122 °F)
- Screw terminal connections
  - Reliable and convenient screw clamp connections
  - Accepts 10-16 AWG wire
  - Meets IP20 specifications for ingress protection
- LED status indication
- Form C contact for remote monitoring
- Five year limited warranty

The STF Elite DIN Rail Mount Series combines SolaHD Tracking technology with UL Listed surge protection to protect against the full spectrum of voltage transients and surges. It continuously tracks the input AC power line responding instantly into action upon detecting extraneous high-frequency noise and high-voltage transients caused by everyday events such as turning on machinery, motors or equipment.

The STFE Series attenuates or reduces the amplitude of normal mode noise to a minimum of -90dB that occurs in a frequency range of 100 kHz to 50 MHz, and common mode noise to a minimum of 60 dB that occurs in a frequency range of 5 MHz to 50 MHz. STFE provides the industry’s best IEEE C62.41 Category A and B Ringwave protection.

The STFE Series is built to meet your unique requirements, and are available in hardwired DIN Rail mount, single phase configuration. They are designed for years of trouble free operation and require little or no operator intervention after installation.

## Connection Diagram

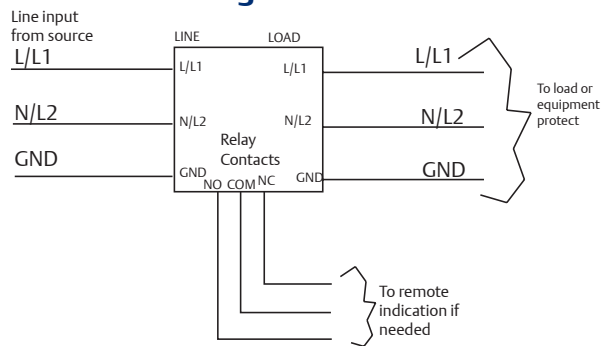

# STFE Series

## Selection Table

Catalog Number	Amps	Input Voltage	
STFE03010N	3.0	120 V	Single Phase, 2 Wire + Ground
STFE05010N	5.0	120 V	Single Phase, 2 Wire + Ground
STFE10010N	10.0	120 V	Single Phase, 2 Wire + Ground
STFE20010N	20.0	120 V	Single Phase, 2 Wire + Ground
STFE03024L	3.0	240 V	Single Phase, 2 Wire + Ground
STFE05024L	5.0	240 V	Single Phase, 2 Wire + Ground
STFE10024L	10.0	240 V	Single Phase, 2 Wire + Ground
STFE20024L	20.0	240 V	Single Phase, 2 Wire + Ground

## Specifications

Description	STFEXXX10N	STFEXXX24L
Input Voltage	120 V (0-150 Vrms)	240 V (0-275 Vrms)
Line Frequency	47 - 63 Hz	
Response Time	< .5 nanoseconds normal mode, <5 nanoseconds common mode	
Enclosure	Fully Enclosed Metal Housing	
Fusing	Reference Fuse/Circuit Breaker Chart	
Status Indication	Green LED "OK"/Form C Contact/10 Amps @ 250 Vac or 5 Amps @ 100 Vdc	
Connection/Mounting Type	DIN Rail Mount	
Operating Temperature	-40 °C to +50 °C (-40 °F to +122 °F) at full load Derate Linearly to 60% at +70 °C (+158 °F)	
Weight - kg ( lbs)	0.70 (1.7)	
Dimensions - mm (in) (H x W x D)	124.0 x 65.0 x 116.0 (4.88 x 2.56 x 4.56)	
Operating Humidity	0% to 95% Non-condensing	
Peak Surge Current Capability	Per Phase	19,500 Amps
	Line to Neutral	13,000 Amps
	Line to Ground	6,500 Amps
	Neutral to Ground	6,500 Amps
Load Surge Current Rating	10 milliseconds	5 x Nominal
	1 second	3 x Nominal
	10 seconds	2 x Nominal
Short Circuit Current Rating (SCCR)	5 kA	
Normal Mode (Forward-Reverse)	100 kHz to 50 MHz	-90 dB maximum
Common Mode (Forward-Reverse)	5 MHz to 50 MHz	-60 dB maximum
Transient Reduction (IEEE C62.41)	Typical Category A Ringwave (6 kV, 200 A, 100 kHz)	< 60 V Peak
	Typical Category B Ringwave (6 kV, 500 A, 100 kHz)	<100 V Peak UL 1449
Warranty	5 year limited warranty	



# STC Series



The rapid development of automated controls, telecommunications and fire/security systems has made it imperative to have properly coordinated low-voltage protection. Modern networked industrial facilities require error free transmission of information for maximum productivity and integrity of data.

The STC Series protects all susceptible low-voltage cable routes entering a facility and at key points within the building. These devices can be used as part of a multi-stage protection strategy which involves clamping the initial high-energy impulse, filtering any remaining noise or transients to the PLC or sensitive equipment and finally, protecting the Data/Signal lines entering and leaving the control panel.

The hybrid design of these Data/Signal Line surge suppressors allows them to respond quickly with high-energy absorption. These units are available in a variety of application specific voltage levels and packaging configurations. The STC Series is used to protect network signal lines entering or leaving control panels including PLCs, universal remote I/O, DeviceNet™ and Data Highway Plus.

## Specialty & Low-Voltage - Data/Signal, STC Series

Series	Application
STC-POE	Power-over-Ethernet, Category 5 and Category 6
STC-DRS	DIN Rail mountable, single-pair surge protection
STC-642	Two-pair data/signal protection
STC-SLAC	Three-stage series hybrid, signal line and AC protection
STC-SS	Multi-stage hybrid suppressors

# STC-POE Series

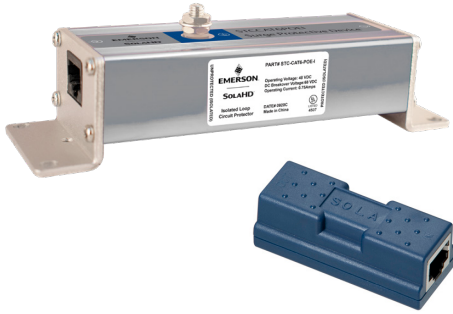

## Features

- Exceeds CAT5 & 6 POE transmission values
- Five year limited warranty

## Features: STCPOE65FF

- Single use fuse design
- 60 Vdc @ 300 mA continuous
- Cost effective protection

## Features: STCCAT6POEI

- Hybrid PTC (positive temperature coefficient) resettable fuse - up to 5,000 times
- 60 Vdc @ 750 mA continuous
- Isolated ground standard
- 10 kA peak surge current
- Premium protection

The SolaHD STC Power-over-Ethernet (PoE) Series is designed to work on Category 5 PoE transmission lines as well as Category 6 applications. They feature female to female RJ-45 connection options for ease of installation.

PoE is a technology for wired Ethernet LANs (Local Area Networks) that allows the electrical current to be carried by the data cables rather than power cords. This minimizes the number of wires that must be strung in order to install the network. The result is lower cost, less downtime, easier maintenance and greater installation flexibility than with traditional wiring.

PoE allows users to power devices over Ethernet cabling. Power and networking is provided over a single cable. PoE has tremendous advantages in industrial applications. The ease of combining signal and power in a single Ethernet cable connection is contributing to the already rapid evolution of Ethernet-based industrial control systems. Category 5e and Category 6 commonly known as Cat5e and Cat6 are the most widely used Ethernet connectivity methods on the market today. Cat5e and Cat6 are defined in ANSI/TIA/EIA 568-B standard for Unshielded Twisted Pair Cabling.

The STC POE Series is ideally suited to protect expensive equipment and critical communication/data transfer from internally generated transients and noise.

# STC-POE Series

## Selection Table

Catalog Number	Description
STCP0E65FF	Female to Female Connector
STCCAT6P0EI	Female to Female Connector with isolated ground
STCCAT6DINKIT	CAT6 POE DIN rail mounting kit

## Specifications

Description	STCP0E65FF	STCCAT6P0EI
Mode of Protection	Normal Mode (L-L) All Lines (1-8) Protected	All Lines (1-8) Protected (L-L) and (L-G) Signal High-Low; High-Ground; Low-Ground
DC Breakover Voltage	60 Vdc	
Insertion Loss	< .1 dB	
Certified Transmission Speeds	10 baseT, 100 baseT, 1000 baseT	
Peak Surge Energy	300 Watt	750 Watt
Response Time	<1 nanosecond	
Connectors	RJ-45 (Female - Female)	
Dimensions - mm (in)	58.4 x 25.4 x 20.3 (2.30 x 1.00 x .80)	137.2 x 40.7 x 43.2 (5.40 x 1.60 x 1.70)
Warranty	5 year limited warranty	

# STC-DRS Series

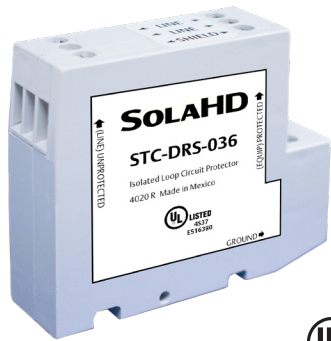

## Applications

- Intended for indoor use on communication loop circuits which have been isolated from the Public Switch Telephone Network

## Features

- Low-Voltage data surge protection
- Three-Stage hybrid technology
- Sneak/Fault current protection with resettable fuses (PTCs)
- Low profile packaging
- Easy installation
- Fits standard 35 mm DIN Rail
- Fast response time <1 nanosecond
- Five year limited warranty

The STC-DRS Series uses three-stage hybrid technology, this DIN Rail mountable, single pair, surge suppressor attenuates overvoltage transients with gas tubes and silicon avalanche components while resettable fuses (PTCs) mitigate sneak currents. The PTC increases resistance by several orders of magnitude when over-currents exceed safe levels. A normal state resumes when over-currents are removed. The ability to self-restore in this manner significantly increases suppressor performance and survivability.

The STC-DRS Series mounts onto a standard 35 mm industrial DIN rail. There are three Field Side and three Electronics Side screw terminals, one is reserved for a shield. Three electrically tied ground terminals are provided for grounding the unit to building-approved ground. The shield is isolated from ground.

## Selection Table

Catalog Number	Max Peak Signal Voltage	Operating Voltage	Max Current 1p 10X1000 ms (Occurrences)	Peak Current 8X20 ms	Typ. Cap (pf)	Max. Continuous Current	Nominal Series Resistance
STCDRS036	43	5-36	>100	10 kA	1500	150 mA	5 Ω

Notes:

*These protectors are intended for indoor use on communication loop circuits.*

*The communication loop circuits shall not be exposed to accidental contact with the electric light or power conductors. The protectors shall be installed per the applicable requirements of the National Electric Code, ANSI/NFPA 70.*

# STC-642 Series



STC-642 shown with DIN Rail Mounting Clip Option

## Applications

- Intended for indoor use on communication loop circuits which have been isolated from the Public Switch Telephone Network
- Ideal for RS232 applications
- Also works well for 4-20 mA signal applications
- For use in service capable of supplying less than 150 milliamperes continuously

## Features

- Surge protection for low-voltage data signal lines
- Three-stage protection (SAD, GDT, PTC)
- Sneak/fault current protection
- Resettable solid-state fuses - PTCs
- Low capacitance option for high speed data
- Plug-in module with base included
- Hybrid design includes series resistance
- Fast response time
- Five year limited warranty

## Selection Table

Catalog Number	Description
STC642036	5-36 Vdc Operating Voltage. Includes module base, designed to accommodate up to 10 AWG wire. The base offers Flat/Philips screws and can be mounted using 2 #6 size screws.
STC642DINKIT	Optional DIN Rail Mounting Clip for STC642DINKIT

The STC-642 Series of surge suppressors are dual pair (four wire) modules using three-stage hybrid technology. This module addresses overvoltage transients with gas tubes and silicon avalanche components. In addition, sneak and fault currents are mitigated with resettable fuses (PTCs). The PTCs increase resistance several orders of magnitude when over currents exceed safe levels. A normal state resumes when over currents are removed. The ability to self restore in this manner significantly increases suppressor performance and survivability.

The card edge module is gold-plated, double sided and is designed to mate with the gold-plated female terminal connector. When snapped together, the data circuits pass thru the protector in a serial fashion from the four Field Side terminals to the four Electronics Side terminals. Terminals 1 or 10 of the STCPCB1B must be attached to building approved ground.

## Specifications

Description	STC642036
Peak Surge Current	8x20 $\mu$ s at 10 kA
Life Expectancy	8x20 $\mu$ s (2000 A) at >100 occurrences
Response Time	<1 nanosecond
Operating Voltage	5-36 Vdc
Technology	GDT/PTC/SAD Hybrid
Resistance	5 Ohms (typical)
Capacitance (typical)	1500 pf
Operating Temperature	-40 °C to +85 °C (-40 °F to +185 °F)
Weight - g (oz)	56.7 (2)
Dimensions H x W x L - mm (in)	52.1 x 25.4 x 61.0 (2.05 x 1.00 x 2.40)
Warranty	5 year limited warranty

# STC-SLAC Series



The STC-SLAC Series surge suppressor is specifically designed to protect sensitive electronics that contain both low-voltage control circuit signal lines and 120 volt AC Power. It combines the technologies found in the STC-642 signal line protector and the STC-HSP advanced three-stage hybrid solid state power line protector. The rugged waterproof NEMA 4X polycarbonate enclosure is suited for installation in the most severe environments. The AC power suppressor features filtering of common and normal mode noise and MOV protection for nanosecond response time. The signal line protector incorporates a design consisting of gas discharge tubes (GDT), thermal resettable fuses (PTC) and silicon avalanche diode components (SAD) for premium protection of signal lines up to 36 volts.

## Applications

- Water treatment facilities
- Industrial manufacturing plant
- Chemical processing plants
- Wastewater treatment facilities
- Agricultural (farms and processing)
- Fish hatcheries
- Food processing

## Features

- Surge suppression for AC power and low-voltage signal lines
- Series hybrid AC suppressor/filter
- User-replaceable protection modules
- 15 Amps replaceable fuse for AC module
- Test jacks for signal line monitoring
- “Power ON” LED indicator
- Internal replaceable fuse
- Screw terminals for ease in serviceability
- Five year limited warranty

## Enclosure Specifications

- NEMA 4X Corrosion Resistant
- Polycarbonate Construction
- Dual knockouts for 20 mm and 32 mm
- Mounting bosses for 6-32 x 3/8 self-tapping screws
- UL 94-0V Flammability Rating

## Specifications

Description		AC Power
<b>Technology</b>	Three-Stage Series Hybrid	
<b>SPD Technology</b>	GDT/PTC/SAD	
<b>Voltage Clamp</b>	325 Vac	
<b>Input Voltage</b>	120 Vac 50/60 Hz	
<b>Output Current</b>	15 Amps Max.	
<b>Response Time</b>	<5 nanoseconds	
<b>Maximum Surge Current (8x20 μs)</b>	39 kA	
Description		Signal Line
<b>Response Time</b>	<5 nanoseconds	
<b>Voltage Clamp</b>	36 Volts	
<b>Maximum Current</b>	150 mA	
<b>Series Resistance</b>	5 Ohms (typical)	
<b>Certification</b>	UL 497B	

## Selection Table

Catalog Number	Description
STCSLAC12036	Surge Suppressor (STC-642 signal line protector and the STC-HSP module)
STCHSP121BT1RU	Replacement AC module
STC642036	Replacement signal line module

# STC-SS Series



## Applications

- Water and wastewater
- Industrial applications

## Features

- Automatic recovery features make it ideal for use in severe environments
- Transient protection for low-voltage signal lines
- Gas tube and silicon avalanche technology
- Sneak/fault current protection
- Resettable fusing—PTCs
- Differential and common mode protection
- Multi-stage hybrid suppressor
- Encapsulated in stainless steel pipe nipples
- UL497B Certified
- Five year limited warranty

## Selection Table

Catalog Number	Description
STCSS640362	1/2" Metal Conduit Capped

The STC-SS Series suppressors are designed for the water and wastewater industry. These multi-stage hybrid suppressors address overvoltage transients with gas tube and silicon avalanche technology. In addition, sneak and electrical fault currents are mitigated with PTC devices which consist of solid-state resettable fuses. The units are encapsulated in stainless steel pipe nipples making them suitable for use in severe environments.

## Specifications

Description	Signal Line Protection
Operating Voltage	28 Vdc
Max Operating Current	150 mA
Clamping Voltage (L-G)	36 Vdc
Clamping Voltage (L-L)	72 Vdc
Peak Surge Current	10 kA (8x20 μs)
SPD Technology	GDT/PTC/SAD Hybrid
Frequency Range	0 to 20 MHz
Insertion Loss	< 0.1 dB at 20 MHz
Series Resistance (per Conductor)	5 Ohms (typical)
Capacitance (Zero Volts Bias)	(L-G) 1200 pf (typical) (L-L) 600 pf (typical)
Operating Temperature	-40 °C to +85 °C (-40 °F to +185 °F)
Life Cycle	400 @ 500 Amps (10x1000 μs)
Weight - lbs (kg)	0.35 (0.16)
Certifications	UL 497B
Warranty	5 year limited warranty

# SolaHD understands that your operations depend on clean, continuous power.



Our full breadth of products convert, clean and maintain electric current from the factory entrance to equipment throughout your facility. Combined with service and support, our total power quality offering can save you time, money and space to ensure optimal production or facility efficiencies.

#### United States (Headquarters)

Appleton Grp LLC  
9377 W. Higgins Road  
Rosemont, IL 60018  
United States  
T +1 800 621 1506

#### Europe

ATX SAS  
Espace Industriel Nord  
35, rue André Durouchez,  
CS 98017  
80084 Amiens Cedex 2, France  
T +33 3 2254 1390

#### Canada

EGS Electrical Group Canada Ltd.  
99 Union Street  
Elmira ON, N3B 3L7  
Canada  
T +1 888 765 2226

#### Asia Pacific

EGS Private Ltd.  
Block 4008, Ang Mo Kio Ave 10,  
#04-16 TechPlace 1,  
Singapore 569625  
T +65 6556 1100

#### Latin America

EGS Comercializadora Mexico S  
de RL de CV  
Calle 10 N°145 Piso 3  
Col. San Pedro de los Pinos  
Del. Álvaro Obregon  
Ciudad de México. 01180  
T +52 55 5809 5049

#### Australia Sales Office

Bayswater, Victoria  
T +61 3 9721 0387

#### China Sales Office

Shanghai  
T +86 21 3338 7000

#### Middle East Sales Office

Dammam, Saudi Arabia  
T +966 13 510 3702

#### Chile Sales Office

Las Condes  
T +56 2928 4819

#### India Sales Office

Chennai  
T +91 44 3919 7300

#### Korea Sales Office

Seoul  
T +82 2 3483 1555

#### Jebel Ali- Dubai Office

Emerson, Building A  
Appleton Group  
Jebel Ali Free Zone- South  
T +971 4 811 81 00



Emerson.com



LinkedIn.com/company/emerson

The Emerson logo is a trademark and service mark of Emerson Electric Co. Appleton is a registered trademark of Appleton Grp LLC. All other marks are the property of their respective owners. © 2021 Emerson Electric Co. All rights reserved.



CONSIDER IT SOLVED™