

ASCO™ Filter, Regulator and Filter Regulator

Stainless Steel 316L, Compact 1/4", High Flow 1/4", 1/2", 3/4", 1"

Series
342

Features

- Stainless Steel filter, regulator and filter regulator intended for corrosive environment and suitable for use in potentially explosive atmosphere caused by gases, vapours, mists and / or dust according to: (ATEX directive 2014/34/EU).
SAFETY CODE:
II 2G Ex h IIC T5 Gb
II 2D Ex h IIIC T100°C Db
(T5 - 90°C ambient temperature)
- Functional Safety: IEC 61508, SIL certified
- Comply with the European Essential Health and Safety Requirements (ISI/IEC 80079-36 & 37)
- All internal metal parts made of 316 / 316L stainless steel
- Built-in overpressure relieving function, non-relieving option available
- Quick relief available#, allowing downstream pressure in the actuator or other instrument to exhaust in the event if supply pressure is lost
- 316L Stainless Steel body, bonnet and bowl
- Internal springs made of INCONEL® to suit sour gas environment complying to NACE MR0175 / ISO 15156*

* Available for High Flow SSFR as an option
INCONEL is trademark of the Special Metals Corporation group of companies

Available for High Flow SSFR and standalone regulator as an option

Benefits

- Precise tuning and regulation - using dual spring design* ^
- Improved regulation accuracy - with pitot tube feedback* ^
- Longer lifespan - using rolling diaphragm
- Effective moisture removal - using fin diverters to create centrifugal action*
- Long lasting product labeling - laser etched marking on stainless steel bowl

* Available for High Flow 1/4" - 1/2" SSFR ^ Available for High Flow 3/4" - 1" SSFR

Characteristics

Fluids	Compact	High Flow (1/4" - 1/2")	High Flow (3/4" - 1")
	Compressed Air, Neutral Gas, Natural Gas	Compressed Air, Neutral Gas, Natural Gas & Sour Natural Gas	
Compliance to NACE for Sour Gas Environment	No	Yes (as an option)	
Quick Relief	Yes	Yes ⁽²⁾ (as an option)	
Ports	1/4"	1/4" & 1/2"	3/4" & 1"
Threads	NPT G as an option		
Pressure Range (Inlet)	0 - 20 bar (Manual Drain) 2.5 - 11 bar (Auto Drain)		
Regulating Pressure (Outlet)	0.5 - 10 bar		
Regulation	By hexagonal head screw with locking nut		
Hysteresis	< 0.32 bar	< 0.2 bar	< 0.25 bar
Filtering Capacity	25 µm & 5 µm		40 µm, 25 µm, 5 µm
Operating Temperature ⁽¹⁾	-40°C to +90°C		
Low Temperature Option	-50°C	-60°C	-
Condensate Drain	Manual & Automatic		

⁽¹⁾ Operating temperature for Automatic Drain: +0°C to +90°C

⁽²⁾ Available for standard temperature of -40°C to +90°C only

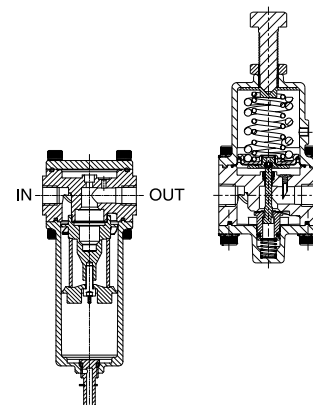
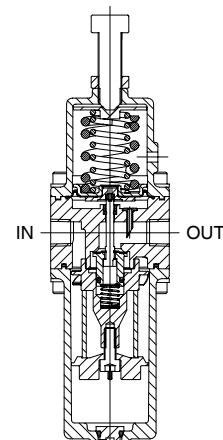
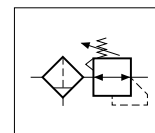

ASCO™ Filter, Regulator and Filter Regulator

Stainless Steel 316L, Compact 1/4", High Flow 1/4", 1/2", 3/4", 1"

Series
342

Construction

	Compact	High Flow (1/4" - 1/2")	High Flow (3/4" - 1")
Body, Bonnet & Bowl	AISI 316L SS		
Bowl Capacity	25 cm ³	75 cm ³	160 cm ³
Filtering Element	AISI 316 SS		
Diaphragm	LT FPM	HNBR	FPM
Elastomers	FPM		

How to Order

342 A 8 0 0 1 AD

Product Series _____
342

Revision _____
A = Initial Release

F/R/FR Type _____
8 = SS Filter Regulator (FR)
9 = SS Filter (F)⁽⁵⁾
A = SS Regulator (R)⁽⁵⁾
⁽⁵⁾ Not available for Compact version.

Pressure Relief/Vent Hole _____
0 = Non relief diaphragm type⁽⁶⁾⁽⁷⁾
2 = ØM5 thread⁽¹⁾
4 = Ø1/8" NPT thread⁽¹⁾
Other connection on request
⁽¹⁾ Not available for filter.
⁽⁶⁾ Automatically "0" for standalone filter option.
⁽⁷⁾ Bonnet with Ø 1/8" NPT thread.

Certifications & Approvals _____
0 = ATEX 1/21 Only
1 = ATEX 1/21 + CUTR
2 = ATEX 1/21 + NACE⁽⁵⁾
3 = ATEX 1/21 + NACE + CUTR⁽⁵⁾
⁽⁵⁾ For 3/4 & 1" available as a special request minimum of 20 pieces.

Options
AD = Automatic Drain⁽²⁾
AN = Automatic Drain with 1/8" NPT Adapter⁽²⁾
G = 316 SS pressure gauge⁽¹⁾⁽⁸⁾⁽⁹⁾⁽¹⁰⁾
K = Quick Relief⁽¹¹⁾
LT = Low Temperature⁽³⁾⁽⁴⁾
MB = 316L SS Mounting Bracket⁽¹⁰⁾
AD + AN is not a possible combination
LT + AD/AN is not a possible combination
⁽¹⁾ Not available for Filter.
⁽²⁾ Not available for Regulator.
⁽³⁾ For High-Flow 1/4" - 1/2" SSFR or Compact SSFR with pressure gauge, a special low temperature 316 SS pressure gauge will be delivered.
⁽⁴⁾ Not available for High-Flow 3/4" - 1" SSFR, standalone filter and regulator
⁽⁸⁾ For High Flow SSFR or Standalone Regulator, a 316 SS pressure gauge with Ø63mm dial and 1/4" NPT gauge port will be delivered.
⁽⁹⁾ For Compact SSFR, a 316 SS pressure gauge with Ø50mm dial and 1/8" NPT gauge port will be delivered.
⁽¹⁰⁾ Not mounted onto the product. Separate packaging.
⁽¹¹⁾ Available for High-Flow SSFR and standalone regulator only.

Filtration/Port Size
1 = High Flow 1/4" NPT 25 µm or Regulator only
2 = High Flow 1/4" G 25 µm or Regulator only
3 = High Flow 1/2" NPT 25 µm or Regulator only
4 = High Flow 1/2" G 25 µm or Regulator only
5 = High Flow 1/4" NPT 5 µm
6 = High Flow 1/4" G 5 µm
7 = High Flow 1/2" NPT 5 µm
8 = High Flow 1/2" G 5 µm
9 = Compact Basic Flow 1/4" NPT 25 µm (4)
A = Compact Basic Flow 1/4" G 25 µm (4)
B = Compact Basic Flow 1/4" NPT 5 µm (4)
C = Compact Basic Flow 1/4" G 5 µm (4)
D = High Flow 3/4" NPT 25 µm or Regulator only
E = High Flow 3/4" G 25 µm or Regulator only
F = High Flow 1" NPT 25 µm or Regulator only
G = High Flow 1" G 25 µm or Regulator only
H = High Flow 3/4" NPT 40 µm
J = High Flow 3/4" G 40 µm
K = High Flow 1" NPT 40 µm
L = High Flow 1" G 40 µm
M = High Flow 3/4" NPT 5 µm
N = High Flow 3/4" G 5 µm
P = High Flow 1" NPT 5 µm
Q = High Flow 1" G 5 µm
⁽⁴⁾ Only available in Filter regulator.
No standalone filter or regulator.

Notes:
• 40 µm, 25 µm & 5 µm filtration are not applicable for standalone regulator.
• 1/8" port size for compact SSFR is also available upon request.
• Standard regulating pressure is 0.5-10 bar. 0.5-2.5 bar is also available upon request.

ASCO™ Filter, Regulator and Filter Regulator

Stainless Steel 316L, Compact 1/4", High Flow 1/4", 1/2", 3/4", 1"

Series
342

Ordering Example

1. Compact low temperature stainless steel filter regulator (1/4" NPT, 25 µm filtration) with low temperature pressure gauge & mounting bracket
 - Product Code: 342A8209GLTMB
2. High-Flow stainless steel filter regulator (1/4" NPT, 25 µm filtration) with auto drain, pressure gauge & mounting bracket
 - Product Code: 342A8201ADGMB
3. High-Flow stainless steel filter regulator (3/4" NPT, 25 µm filtration) with auto drain, pressure gauge & mounting bracket
 - Product Code: 342A820DADGMB

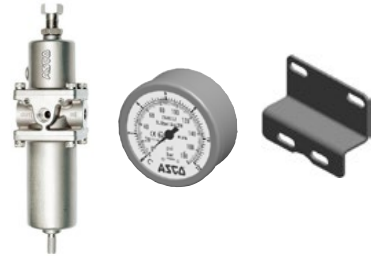

Maximum Flow Values

Construction Type	Maximum Flow Values Following ISO Standards 5782, 6358 and 6953	Compact		High Flow (1/4" - 1/2")				High Flow (3/4" - 1")					
		Litres Per Minute (ANR)											
		1/4" NPT		1/4" NPT		1/2" NPT		3/4" NPT			1" NPT		
		5 µm	25 µm	5 µm	25 µm	5 µm	25 µm	5 µm	25 µm	40 µm	5 µm	25 µm	40 µm
Filter	Inlet pressure = 6.3 bar & ΔP = 1 bar	-	-	1780	2600	1800	3300	2200	3900	5100	2350	4200	5500
Regulator	Inlet pressure = 10 bar, setpoint = 6.3 bar & ΔP = 1 bar	-	-	3120		7800		9150			10200		
Filter Regulator	Inlet pressure = 10 bar, setpoint = 6.3 bar & ΔP = 1 bar	1280	1400	2380	2450	3920	4430	4550	7500	8500	5000	7750	9500

Auto Drain			
	COMPACT SSFR	HIGH FLOW SSFR (1/4" - 1/2")	HIGH FLOW SSFR (3/4" - 1")
			
Max. Inlet Pressure	11 bar		
Operating Pressure	2.5 - 11 bar		
Operating Temp.	0°C to +90°C		
Metal Parts	316L SS		
Elastomers	FPM		
Float	Rigid Polyurethane	PP material	Rigid Polyurethane
Adaptor (316 SS) for 1/8 NPT conversion "AN" as option			

Pressure Gauge			
	COMPACT SSFR	HIGH FLOW SSFR (1/4" - 1/2")	HIGH FLOW SSFR (3/4" - 1")
			
Pressure	0 - 10 bar	0 - 12 bar	
Diameter	Ø 50 mm	Ø 63 mm	
Gauge Port Size	1/8" NPT	1/4" NPT	
Material	316 Stainless Steel		
Protection	IP65; Safety glass; Fixed crimped case to avoid accidental dismounting		
Kit Number	C325937	C325316	
Kit Number (For Low temp)	C325938	C325667	-

Mounting Bracket			
	COMPACT SSFR	HIGH FLOW SSFR (1/4" - 1/2")	HIGH FLOW SSFR (3/4" - 1")
			
Material	316L Stainless Steel		
Kit Number	C117877	C117813	

Option	Weight (kg)
Auto Drain	0.015
Adaptor for Auto Drain	0.020
Pressure Gauge	0.164
Mounting Bracket	0.079

Installation

- Installation / Maintenance instructions are included with each filter/regulator
- Air flow direction indicated by IN/OUT as well as inlet & outlet indicators
- Pipe connection has standard thread according to NPT (ANSI 1.20.3)

ASCO™ Filter, Regulator and Filter Regulator

Stainless Steel 316L, Compact 1/4", High Flow 1/4", 1/2", 3/4", 1"

Series
342

Dimensions (mm), Weight (kg)

Filter

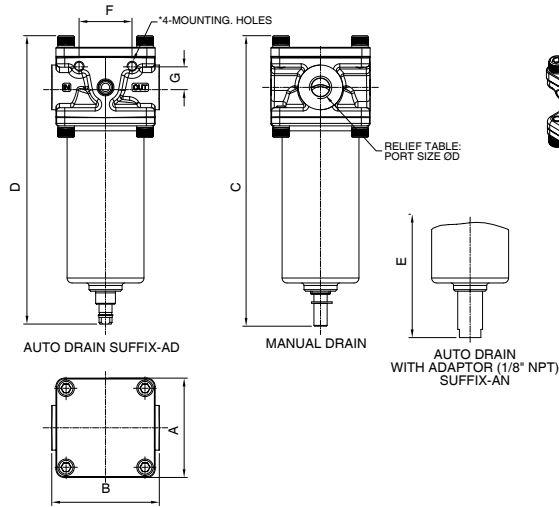

Regulator

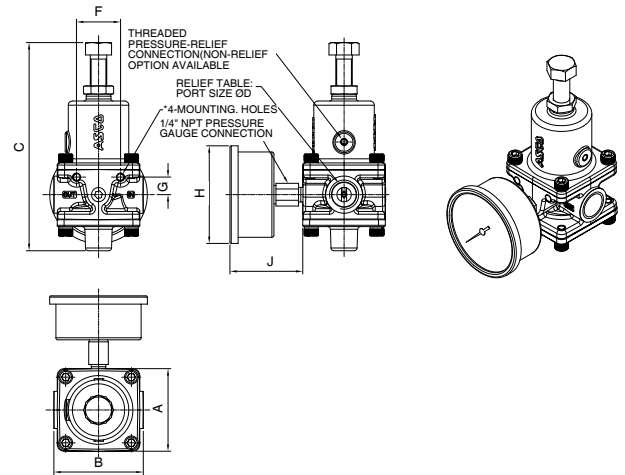

Filter Regulator

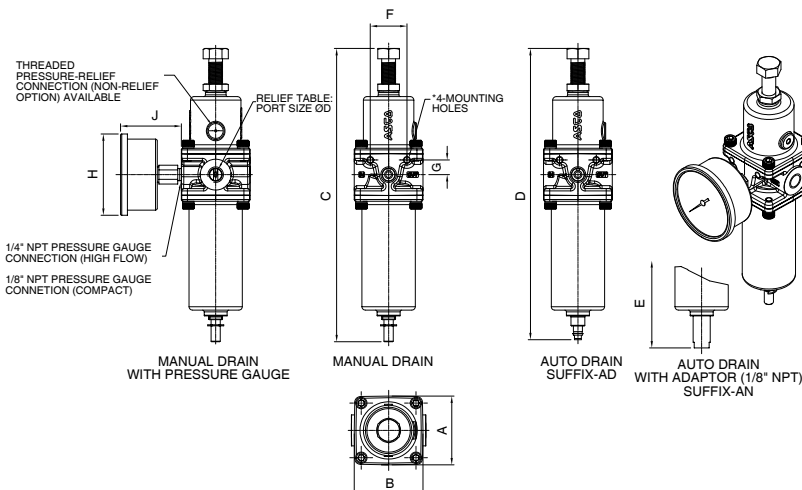

Mounting Bracket

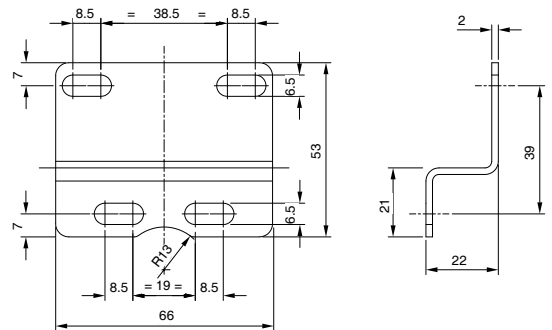

Dimensions (mm), Weight (kg)

	Type	ØD NPT	Weight (kg)	A		C	D	E	F	G	H	J
				A	B							
COMPACT	Filter Regulator	1/4"	1.0	45	45	185	223	233	20	10	Ø58	53
HIGH FLOW	Filter	1/4"	1.4	60	65	177	175	183	32	12.75	-	-
		1/2"	5.0	85	90	242	240	250	32	21	-	-
		3/4"	5.0	85	90	242	240	250	32	21	-	-
	Regulator	1/4"	1.2	60	65	151.3	-	-	32	12.75	Ø71	51
		1/2"	4.5	85	90	230	-	-	32	21	Ø71	52
		3/4"	4.5	85	90	230	-	-	32	21	Ø71	52
	Filter Regulator	1/4"	2.0	60	65	256	254	261	32	12.75	Ø71	51
		1/2"	6.0	85	90	329	327	337	32	21	Ø71	52

* Note: Mounting hole for Hi-Flow 1/4", 1/2", 3/4" & 1" SSFR are M6 in size.
Mounting hole for Compact SSFR is M5 in size.

Spare Parts Kits

	Type	Filtering Capacity	Spare Parts Kit Number-Standard	Spare Parts Kit Number-Low Temp
COMPACT				
1/4"	Filter Regulator	25 µm	C325921	C325996
		5 µm	C325922	C325997
HIGH FLOW				
1/4" - 1/2"	Filter	25 µm	C325309	
		5 µm	C325310	
	Regulator	-	C325311	C325993
		Filter Regulator	25 µm	C325305
	3/4" - 1"	Filter	40 µm	C326171
25 µm			C326172	-
5 µm			C326173	-
Regulator		-	C326174	-
		Filter Regulator	40 µm	C326176
Filter Regulator	25 µm	C326177	-	
	5 µm	C326178	-	

ASCO™ Filter, Regulator and Filter Regulator

Stainless Steel 316L, Compact 1/4", High Flow 1/4", 1/2", 3/4", 1"

Series
342

Pressure Drop Vs. Air Flow Curves

High Flow St. steel filter 1/2" NPT Ref. : 342A9007
Filtration 5 μm with P inlet 4 - 6.3 - 8 - 10 bar

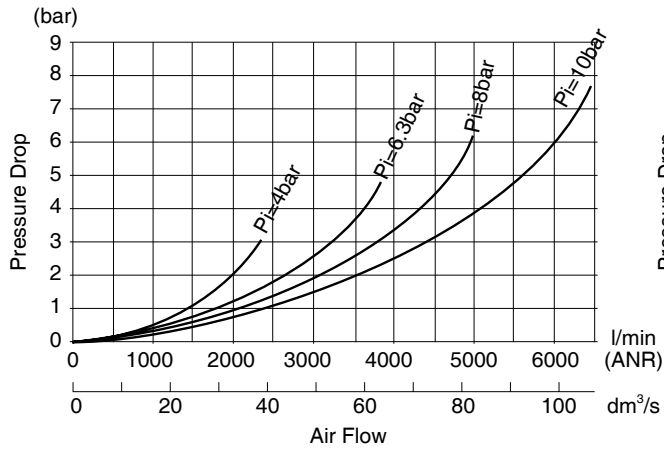

High Flow St. steel filter 1/2" NPT Ref. : 342A9003
Filtration 25 μm with P inlet 4 - 6.3 - 8 - 10 bar

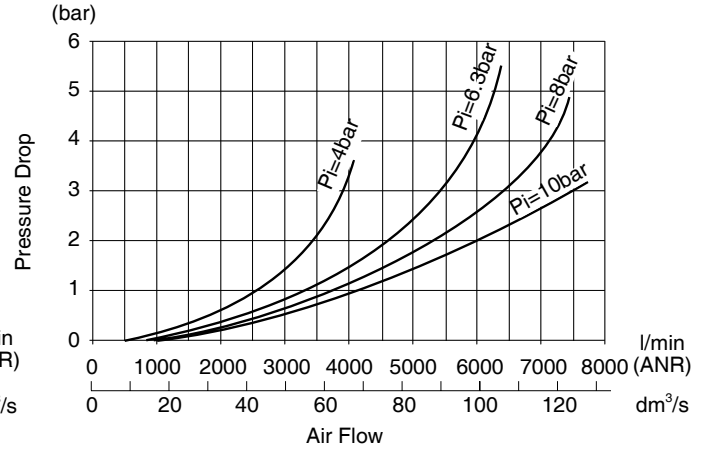

High Flow St. steel filter 1/4" NPT Ref. : 342A9005
Filtration 5 μm with P inlet 4 - 6.3 - 8 - 10 bar

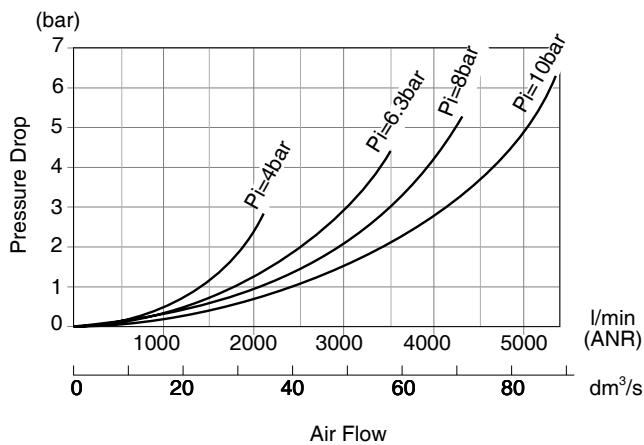

High Flow St. steel filter 1/4" NPT Ref. : 342A9001
Filtration 25 μm with P inlet 4 - 6.3 - 8 - 10 bar

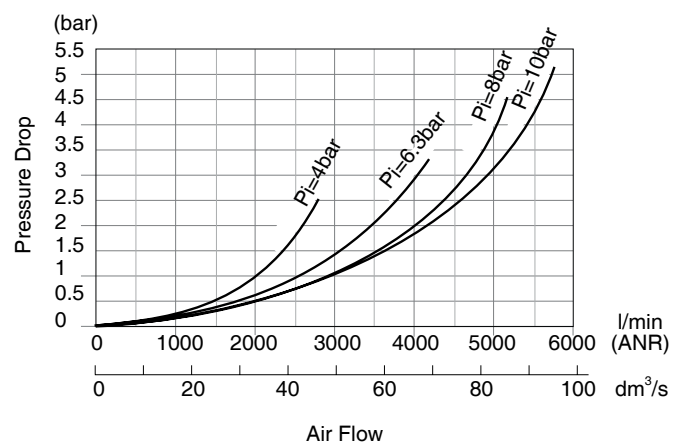

High Flow St. steel filter 3/4" NPT Ref. : 342A920M
Filtration 5 μm with P inlet 4 - 6.3 - 8 - 10 bar

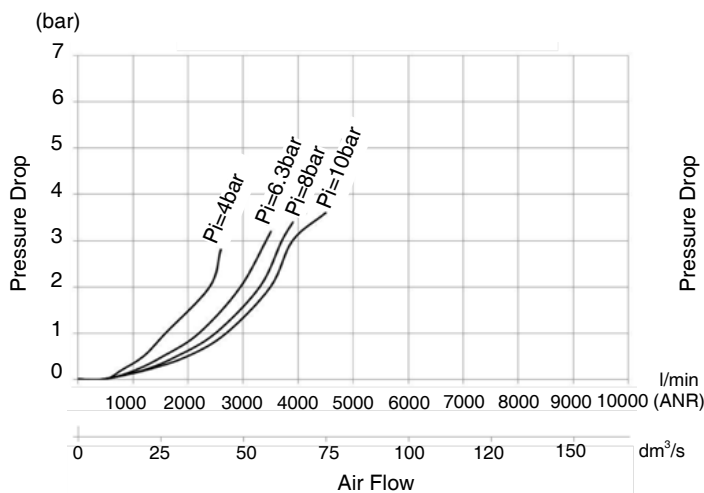

High Flow St. steel filter 3/4" NPT Ref. : 342A920D
Filtration 25 μm with P inlet 4 - 6.3 - 8 - 10 bar

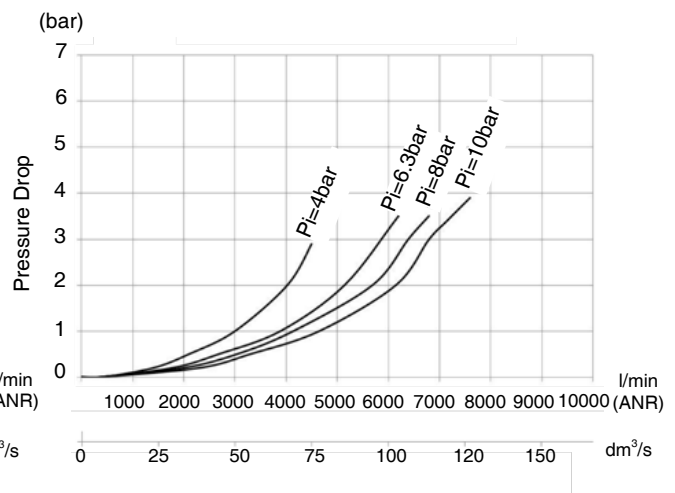

ASCO™ Filter, Regulator and Filter Regulator

Stainless Steel 316L, Compact 1/4", High Flow 1/4", 1/2", 3/4", 1"

Series
342

Pressure Drop Vs. Air Flow Curves

High Flow St. steel filter 3/4" NPT Ref. : 342A920H
Filtration 40 µm with P inlet 4 - 6.3 - 8 - 10 bar

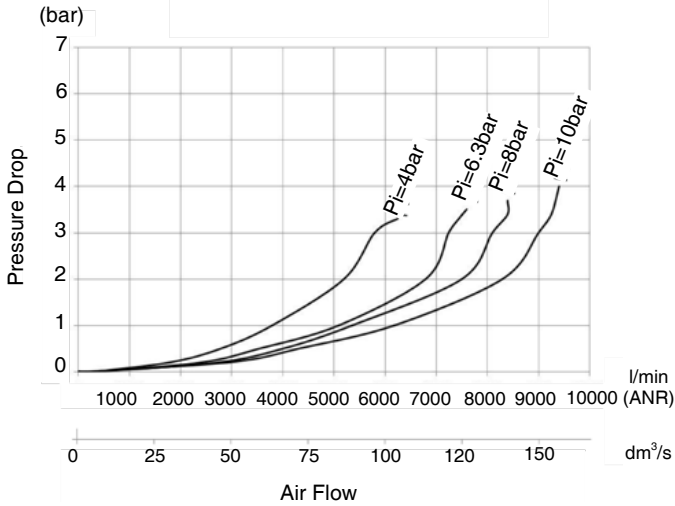

High Flow St. steel filter 1" NPT Ref. : 342A920P
Filtration 5 µm with P inlet 4 - 6.3 - 8 - 10 bar

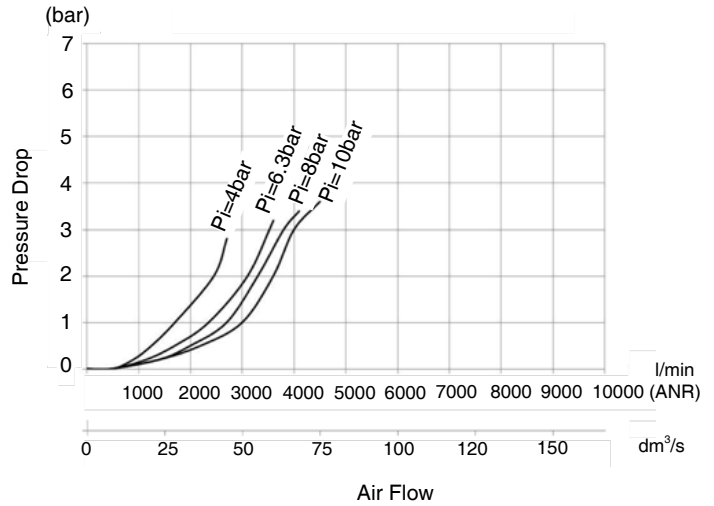

High Flow St. steel filter 1" NPT Ref. : 342A920F
Filtration 25 µm with P inlet 4 - 6.3 - 8 - 10 bar

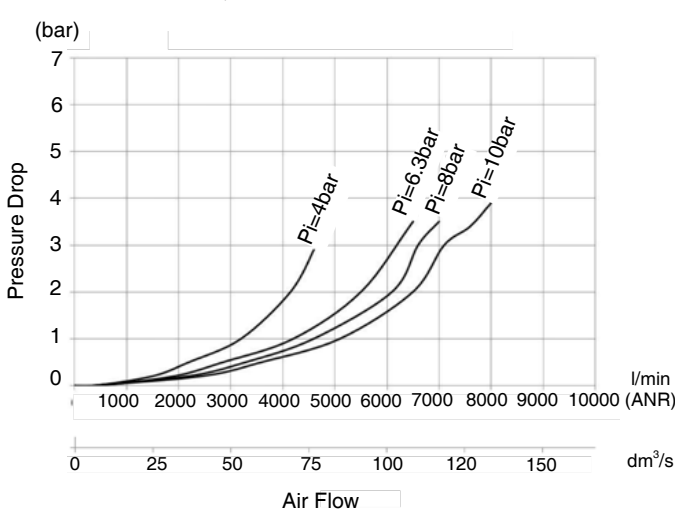

High Flow St. steel filter 1" NPT Ref. : 342A920K
Filtration 40 µm with P inlet 4 - 6.3 - 8 - 10 bar

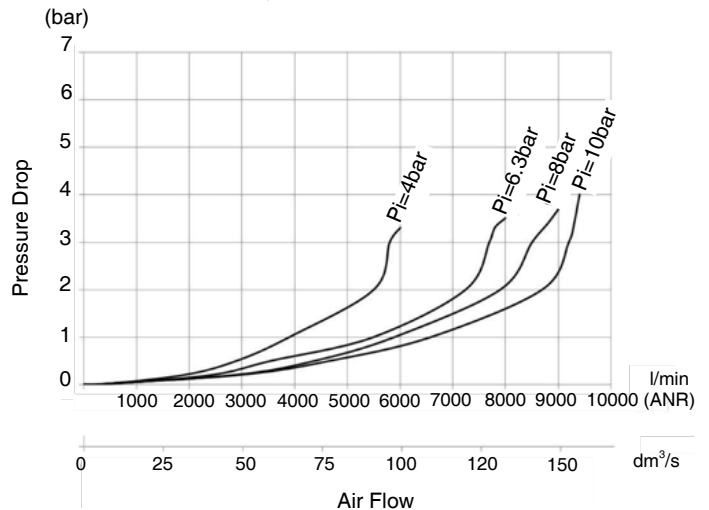

High Flow St. steel regulator 1/2" NPT Ref. : 342AA403
P inlet 10 b - setpoint 4 - 6.3 - 8 bar

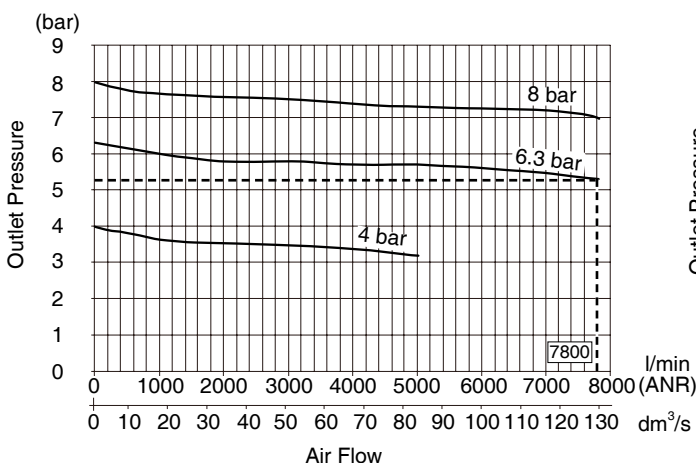

High Flow St. steel regulator 1/4" NPT Ref. : 342AA401
P inlet 10 b - setpoint 4 - 6.3 - 8 bar

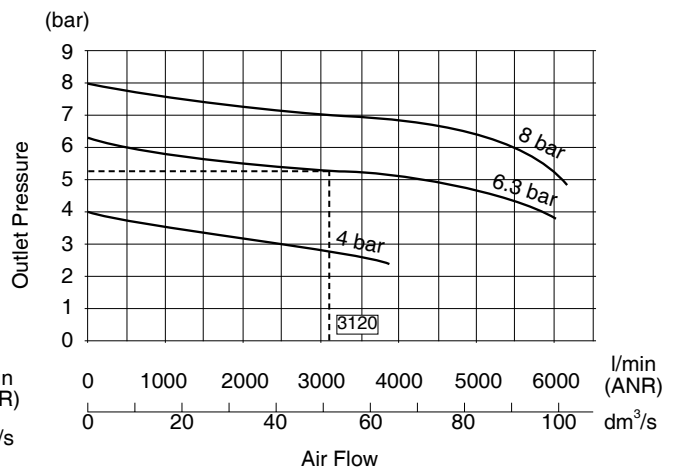

ASCO™ Filter, Regulator and Filter Regulator

Stainless Steel 316L, Compact 1/4", High Flow 1/4", 1/2", 3/4", 1"

Series
342

Pressure Drop Vs. Air Flow Curves

High Flow St. steel regulator 3/4" NPT Ref. : 342AA20D
P inlet 10 b - setpoint 3.15 - 5 - 6.3 bar

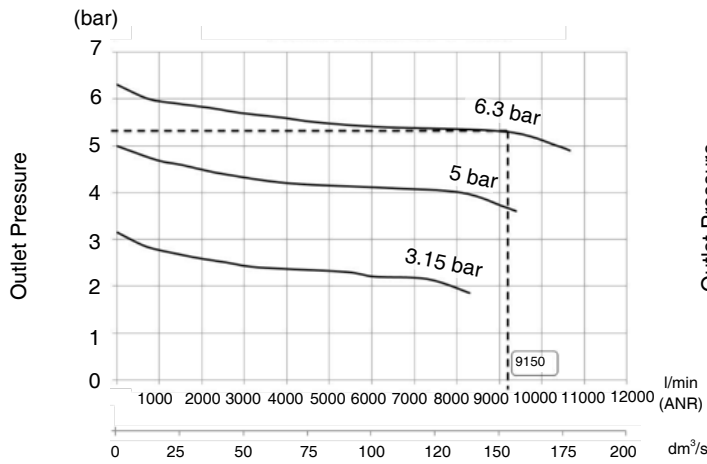

High Flow St. steel regulator 1" NPT Ref. : 342AA20F
P inlet 10 b - setpoint 3.15 - 5 - 6.3 bar

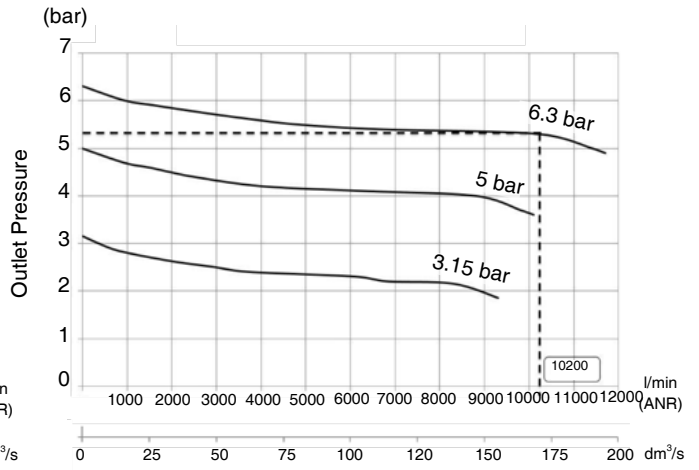

High Flow St. steel filter regulator 1/2" NPT Ref : 342A8203
Filtration 25 µm with P inlet 10 b - setpoint 3.15 - 5 - 6.3 bar

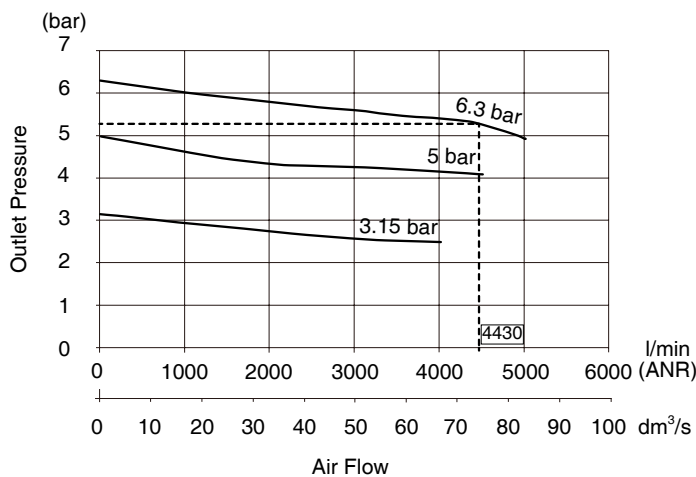

High Flow St. steel filter regulator 1/4" NPT Ref. : 342A8201
Filtration 25 µm with P inlet 10 b - setpoint 3.15 - 5 - 6.3 bar

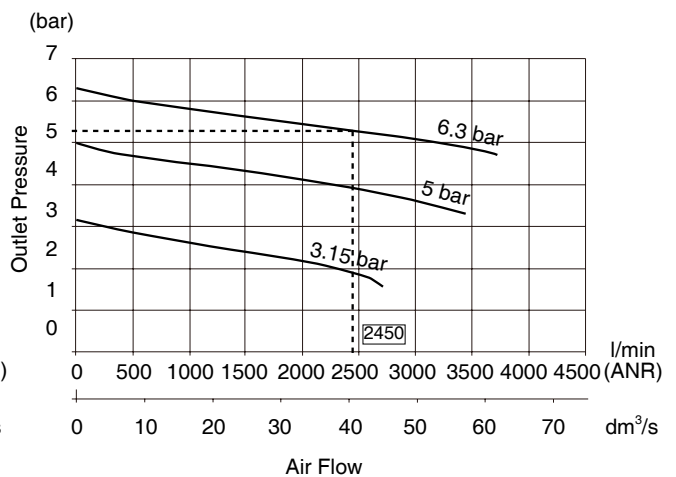

High Flow St. steel filter regulator 1/2" NPT Ref : 342A8207
Filtration 5 µm with P inlet 10 b - setpoint 3.15 - 5 - 6.3 bar

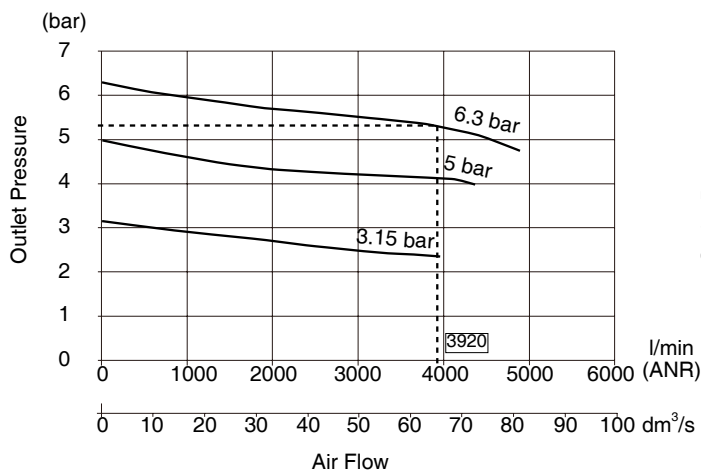

High Flow St. steel filter regulator 1/4" NPT Ref. : 342A8205
Filtration 5 µm with P inlet 10 b - setpoint 3.15 - 5 - 6.3 bar

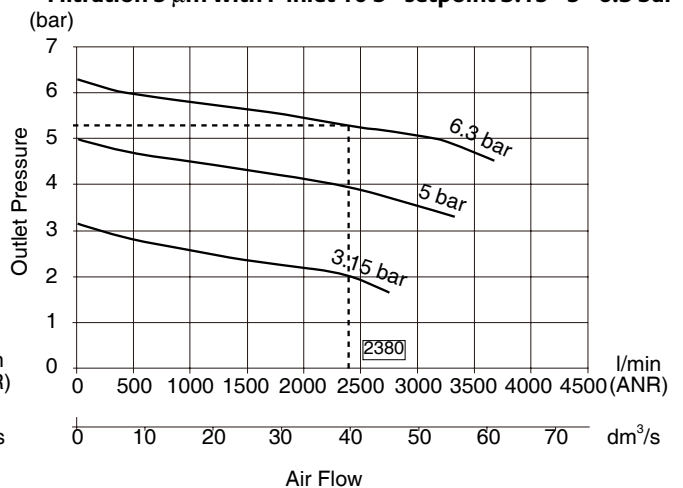

ASCO™ Filter, Regulator and Filter Regulator

Stainless Steel 316L, Compact 1/4", High Flow 1/4", 1/2", 3/4", 1"

Series
342

Pressure Drop Vs. Air Flow Curves

Compact St. steel filter regulator 1/4" NPT Ref : 342A820B
Filtration 5 µm with P inlet 10 b - setpoint 3.15 - 5 - 6.3 bar

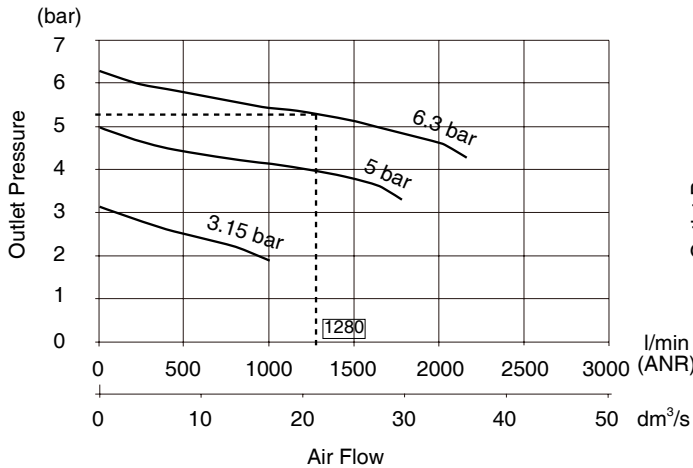

Compact St. steel filter regulator 1/4" NPT Ref : 342A8209
Filtration 25 µm with P inlet 10 b - setpoint 3.15 - 5 - 6.3 bar

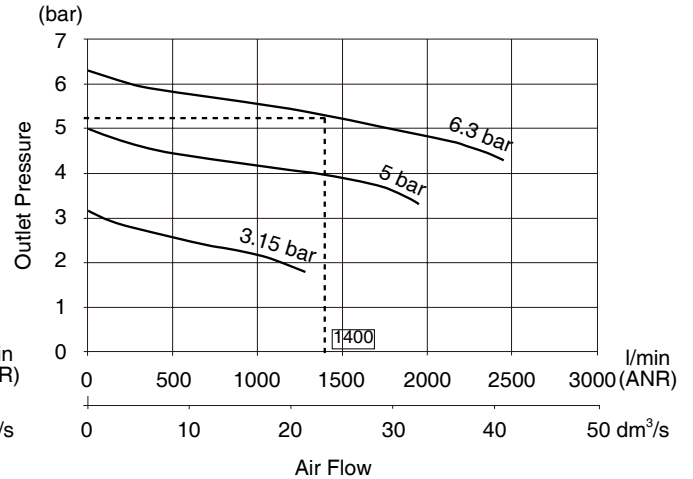

High Flow St. steel filter regulator 1" NPT Ref : 342A820K
Filtration 40 µm P inlet 10 b - setpoint 3.15 - 5 - 6.3 bar

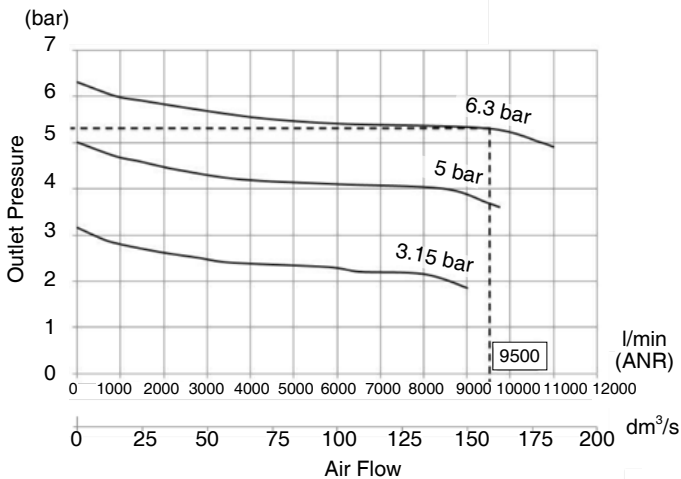

High Flow St. steel filter regulator 1" NPT Ref : 342A820F
Filtration 25 µm P inlet 10 b - setpoint 3.15 - 5 - 6.3 bar

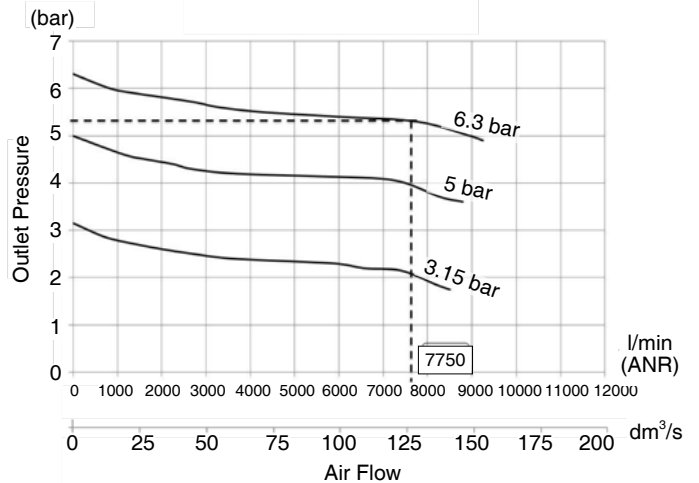

High Flow St. steel filter regulator 1" NPT Ref : 342A820P
Filtration 5 µm P inlet 10 b - setpoint 3.15 - 5 - 6.3 bar

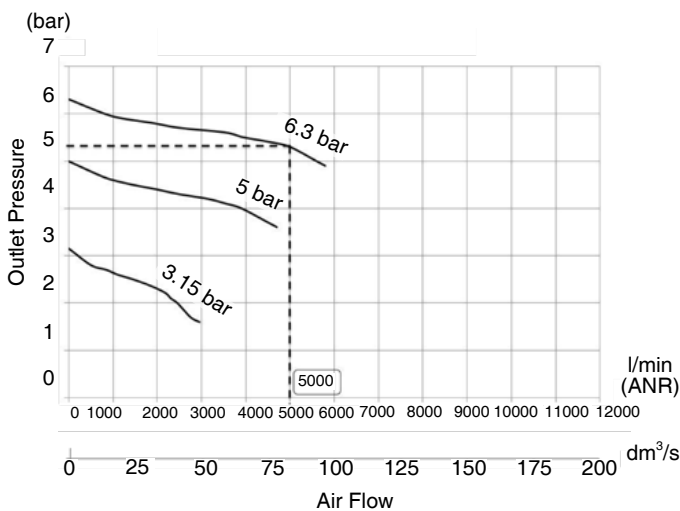

High Flow St. steel filter regulator 3/4" NPT Ref : 342A820H
Filtration 40 µm P inlet 10 b - setpoint 3.15 - 5 - 6.3 bar

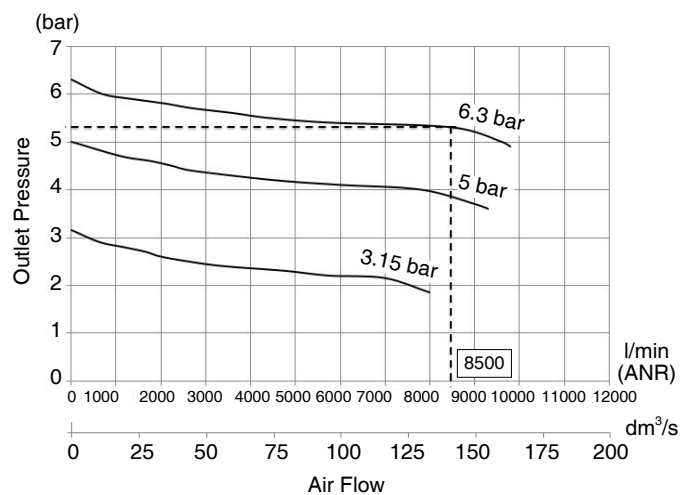

ASCO™ Filter, Regulator and Filter Regulator

Stainless Steel 316L, Compact 1/4", High Flow 1/4", 1/2", 3/4", 1"

Series
342

Pressure Drop Vs. Air Flow Curves

High Flow St. steel filter regulator 3/4" NPT Ref : 342A820D
Filtration 25 µm P inlet 10 b - setpoint 3.15 - 5 - 6.3 bar

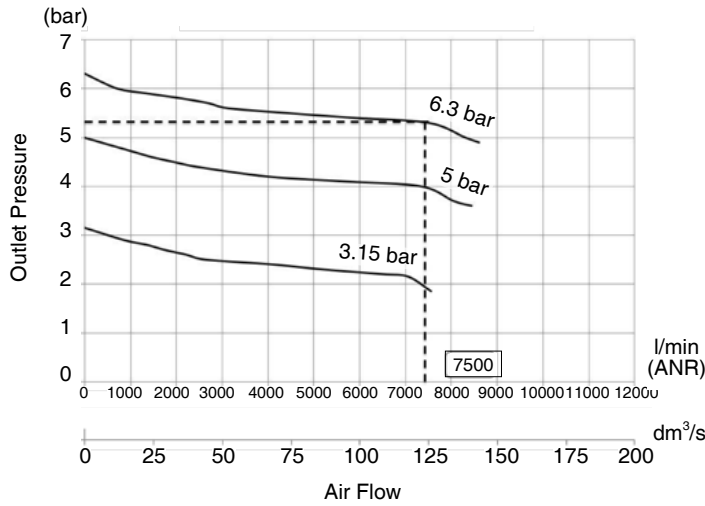

High Flow St. steel filter regulator 3/4" NPT Ref : 342A820M
Filtration 5 µm P inlet 10 b - setpoint 3.15 - 5 - 6.3 bar

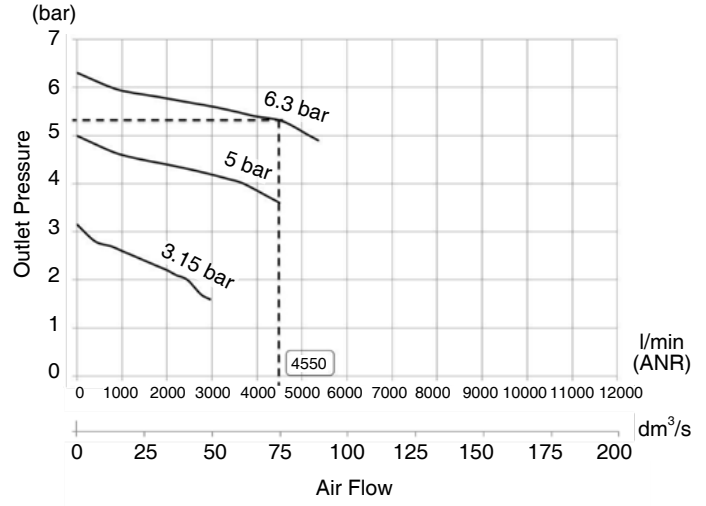

Availability, design and specifications are subject to change without notice. All rights reserved.
2024-04-16