

Universal gripper UG

UG 20 & UG 25

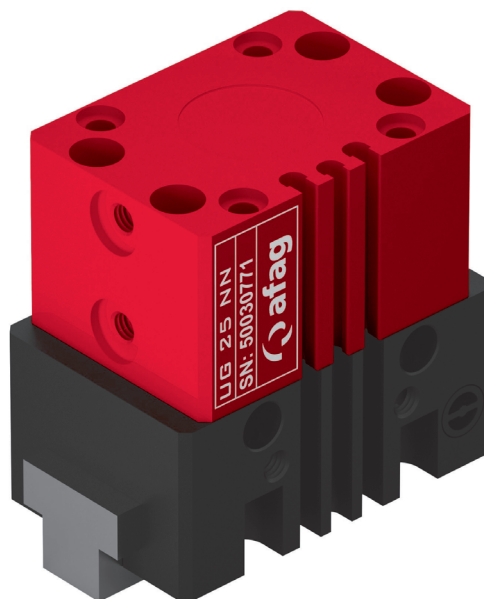
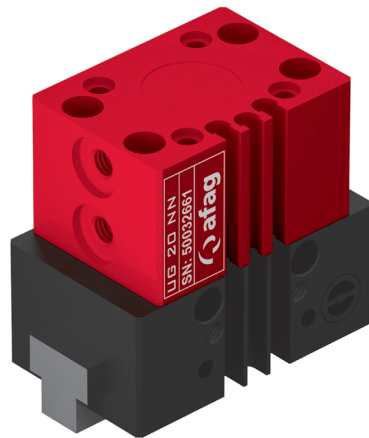
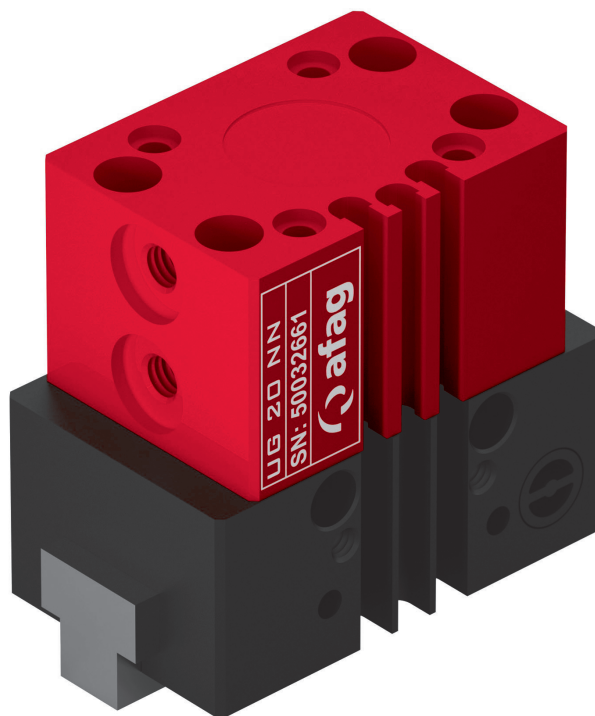

Table of contents: UG

Universal gripper UG		Page
UG 20		117
UG 25		123

Universal gripper UG

UG 20



- Compact and light
- Third sensor for part recognition
- Gripping force securing

Dimensions and dimension drawings

UG 20

Type	UG 20 NN	UG 20 NC	UG 20 NO
A	Sensor Ø 4 mm	Sensor Ø 4 mm	Sensor Ø 4 mm
B	Proximity switch	Proximity switch	Proximity switch

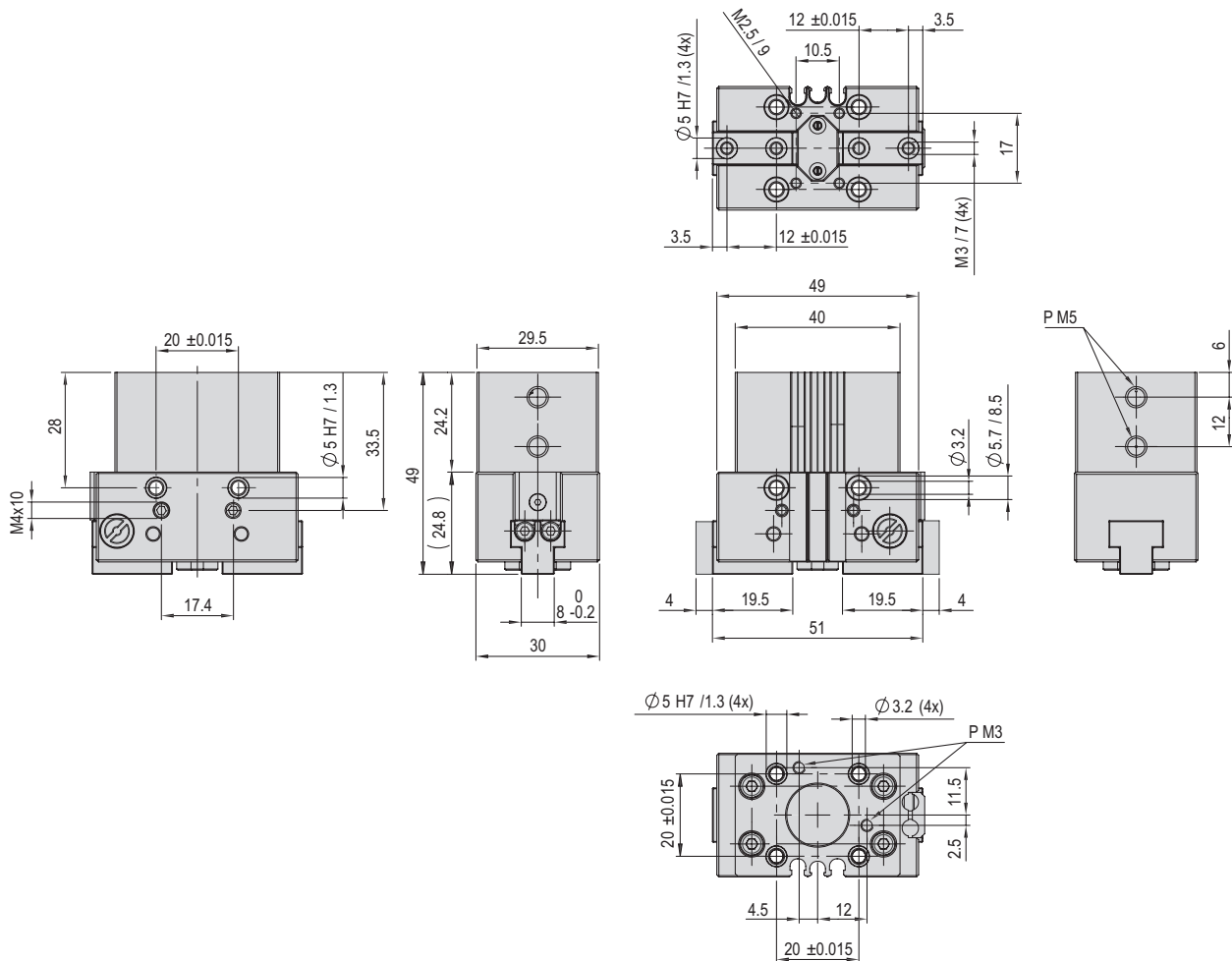

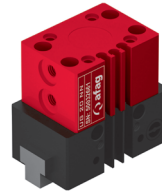

UG 20	
Attachment grid	20 x 20 mm
Attachment thread	Mounting holes 3.2 mm
Operating pressure	6 +/- 2 bar
Air connection P	M5
Cylinder Ø	20 mm
Operating temperature	0 - 50 °C

Type	UG 20 NN	UG 20 NC	UG 20 NO
Order number	50032661	50032663	50032664
Net weight	0.17 kg	0.172 kg	0.172 kg
Air consumption/cycle	0.0239 NL	0.0239 NL	0.0239 NL
Gripping time	0.03 s	0.03 s	0.03 s
Closing time	**Closing time = Finger weight 0.20 s = 150 g 0.05 s = 100 g 0.03 s = 80 g		
Gripping force, opening	178 N	139 N	226 N
Gripping force, closing	150 N	188 N	105 N
Max. admissible weight per gripper finger	150 g	150 g	150 g
Spring force		38 N	48 N
Opening stroke	2 x 4 mm	2 x 4 mm	2 x 4 mm
Repeat accuracy	+/- 0.02 mm	+/- 0.02 mm	+/- 0.02 mm
Mounting position	✦	✦	✦

The technical data refer to a nominal pressure of 6 bar under Afag standard test conditions.
 The module can be operated with lubricated or dry air.
 Cleanroom class ISO 14644-1, class ISO 7

- *Observe gripping force diagrams
- Measurements for slowly closing fingers
- All module measurements carried out via outer clamping
- **Closing times in unthrottled operation Observe gripping force diagrams
- Measurements for slowly closing fingers
- All module measurements carried out via outer clamping

Included in the delivery

- (Catalogue HT accessories)
- 2x Centering bushing Ø5x2.5
 - 2x Mounting screw M3x30
 - 4x Mounting screw M3x50

Accessories

- (Catalogue HT accessories)
- INI c10x19.5-Em-PNP-NO-M8x1
 - INI c10x28.5-Em-PNP-NO-M8x1

Alternative accessories

- (Catalogue HT accessories)
- INI d4x25-Sn1.0-PNP-NC-M8x1
 - INI d4x25-Sn1.0-PNP-NO-M8x1
 - INI M4x12-Sn0.8-PNP-NO

Warranty: 24 months following commissioning, but a maximum of 27 months following delivery



CS 12	1,3	VP 107	1,2
CS 16	1,3	VP 107	1,2
LM 16	1	VP 115	1,2
LM 20	1	VP 115	1,2
LM 25	1	VP 115	1,2
LM 32	1	VP 115	1,2
HM 10	1	VP 107	1,2
CR 12	3	< direct >	1,2
CR 16	3	< direct >	1,2
RM 16	3	VF 404	1,2
RM 25	3	VF 404	1,2
ES20	1,3	VP 107	1,2
ES30	1	< direct >	1,2
SA-1	1	< direct >	2
SA-3	1,2	VP 107	1,2
SA-6	1,2	VP 107	1,2
RE-50	3	< direct >	1
	3	VP 107	2
SREH-50	3	VP 160	1,2
RA-40	3	VP 50486391	2

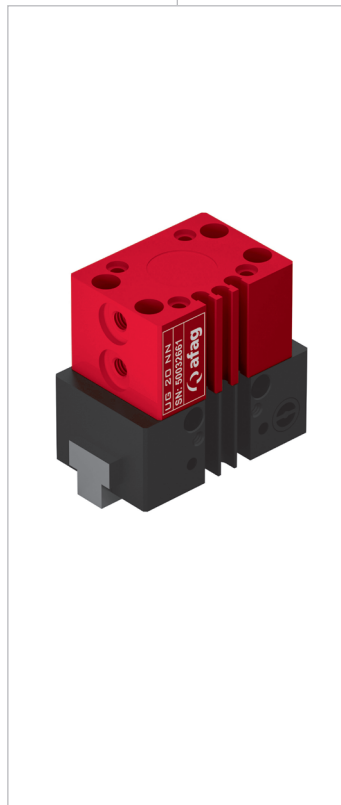

Mounting areas

CS, ES	LM	HM	SA	UG, GM, SG, DG, PG, GE, SGE
PMP, PMP-c	PEZ, PDZ	PEL, PDL	RM, RE	CR, RM 32, RE, SREH, RA

Note that there might be different mounting positions from one module to another one.
The required connection elements and the range of support columns are depicted in the catalogue HT accessories.

Type	UG 20 NN
Max. static torque M_x	7 Nm
Max. static torque M_y	7 Nm
Max. static torque M_z	7 Nm
Max. dynamic torque M_x	0.07 Nm
Max. dynamic torque M_y	0.07 Nm
Max. dynamic torque M_z	0.07 Nm
Max. static force F	150 N
Max. dynamic force F	1.5 N

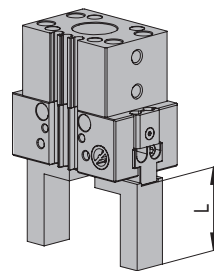
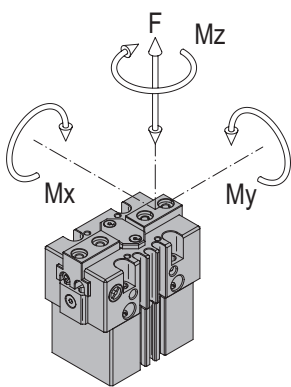

Finger length centric

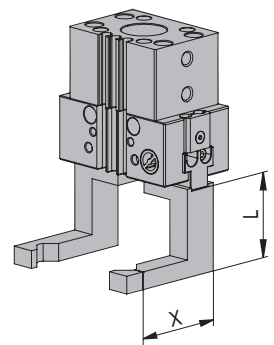

Finger length eccentric

Gripping force diagrams per jaw

Eccentric - UG 20 NN opening

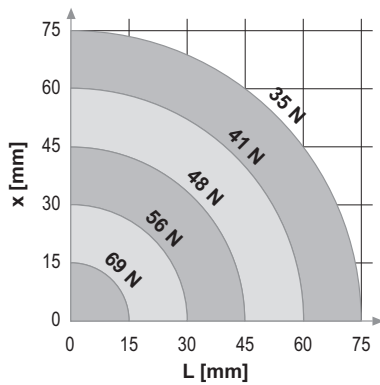

Eccentric - UG 20 NN closing

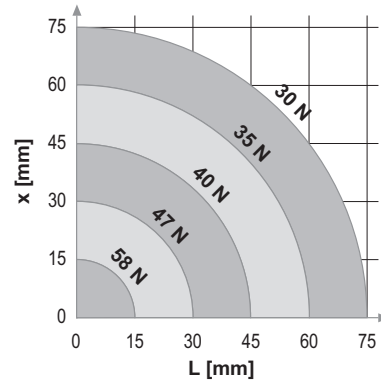

Centric - UG 20 NN opening

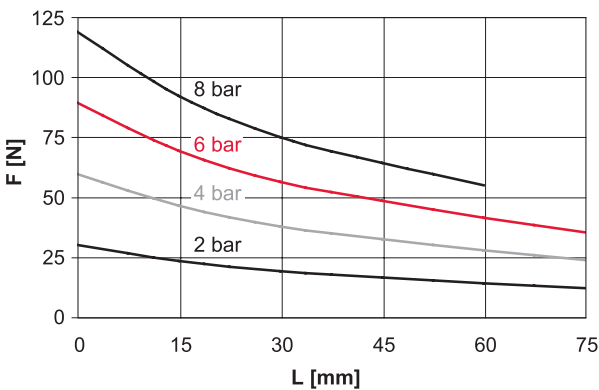

Centric - UG 20 NN closing

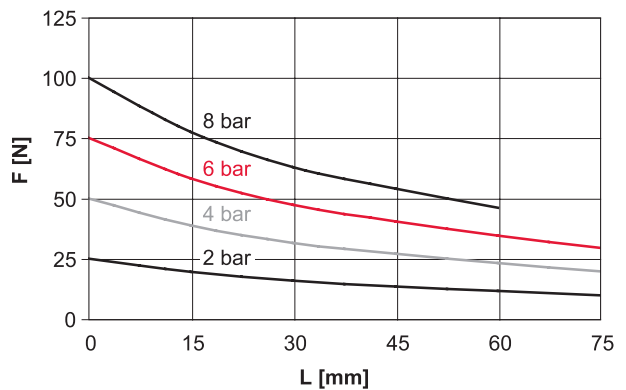

Eccentric - UG 20 NC closing

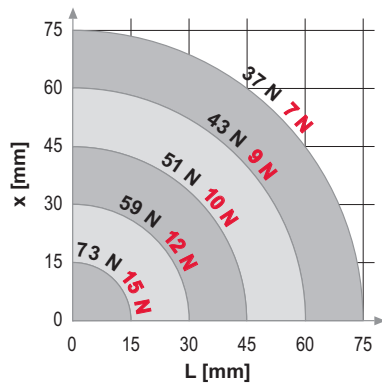

Centric - UG 20 NC closing

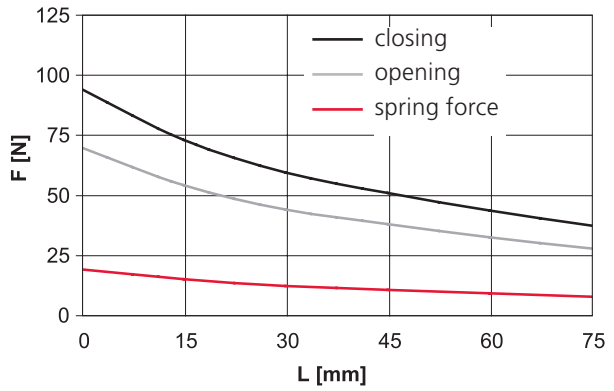

Eccentric - UG 20 NN opening

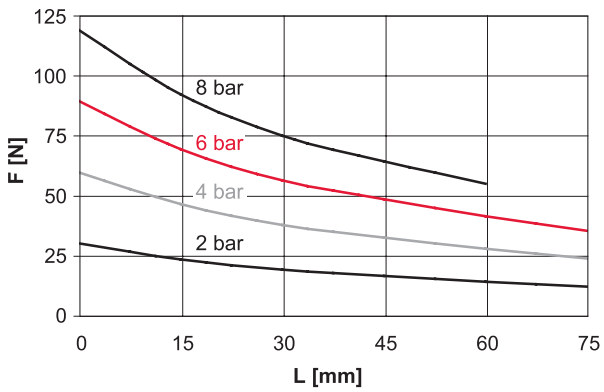

Centric - UG 20 NO opening

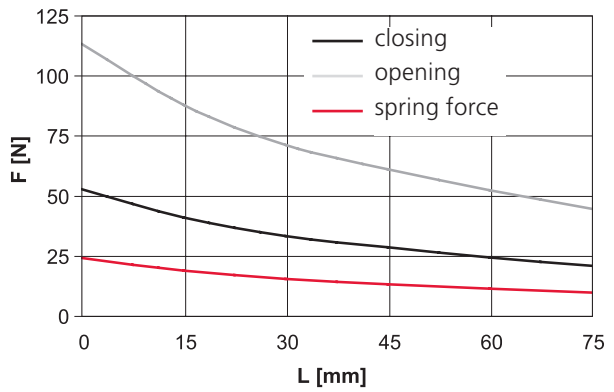

Universal gripper UG

UG 25

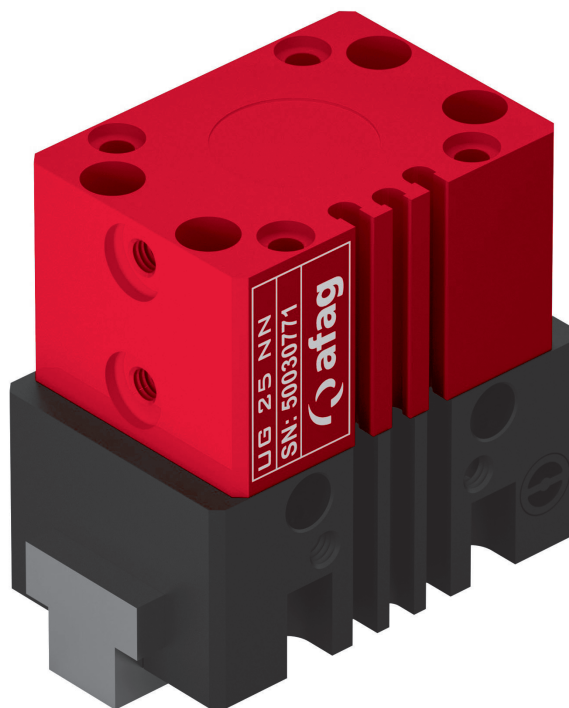

- Compact and light
- Third sensor for part recognition
- Gripping force securing

Type	UG 25 NN	UG 25 NC	UG 25 NO
A	Sensor Ø 4 mm	Sensor Ø 4 mm	Sensor Ø 4 mm
B	Proximity switch	Proximity switch	Proximity switch

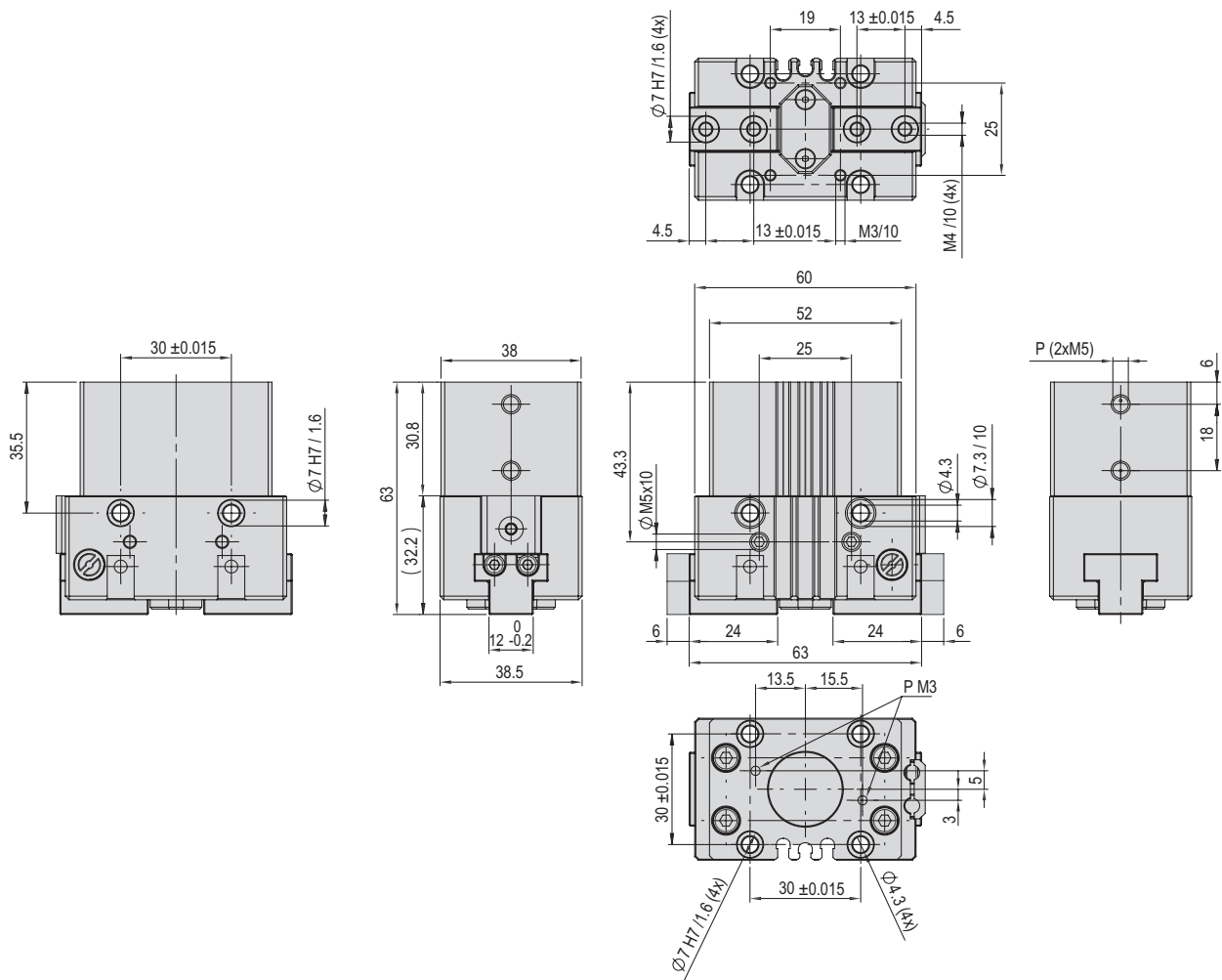

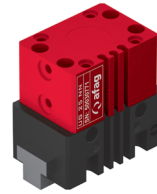

UG 25	
Attachment grid	30 x 30 mm
Attachment thread	Mounting holes 4.3 mm
Operating pressure	6 +/- 2 bar
Air connection P	M5
Cylinder Ø	25 mm
Operating temperature	0 - 50 °C

Type	UG 25 NN	UG 25 NC	UG 25 NO
Order number	50030771	50030772	50030773
Net weight	0.384 kg	0.389 kg	0.388 kg
Air consumption/cycle	0.0552 NL	0.0552 NL	0.0552 NL
Gripping time	0.05 s	0.05 s	0.05 s
Closing time	**Closing time = Finger weight 0.20 s = 250 g 0.05 s = 150 g 0.03 s = -		
Gripping force, opening	*334 N	*268 N	*407 N
Gripping force, closing	*300 N	*366 N	*227 N
Max. admissible weight per gripper finger	250 g	250 g	250 g
Spring force		66 N	73 N
Opening stroke	2 x 6 mm	2 x 6 mm	2 x 6 mm
Repeat accuracy	+/- 0.02 mm	+/- 0.02 mm	+/- 0.02 mm
Mounting position	✦	✦	✦

The technical data refer to a nominal pressure of 6 bar under Afag standard test conditions.
The module can be operated with lubricated or dry air.
Cleanroom class ISO 14644-1, class ISO 7

- *Observe gripping force diagrams
- Measurements for slowly closing fingers
- All module measurements carried out via outer clamping
- **Closing times in unthrottled operation Observe gripping force diagrams
- Measurements for slowly closing fingers
- All module measurements carried out via outer clamping.

Included in the delivery

(Catalogue HT accessories)

- 2x Centering bushing Ø7x3
- 2x Mounting screw M4x35
- 4x Mounting screw M4x55

Accessories

(Catalogue HT accessories)





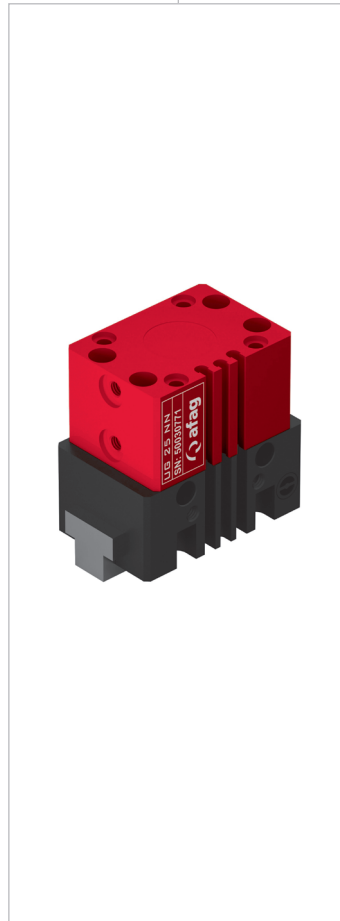

- INI c10x19.5-Em-PNP-NO-M8x1
- INI c10x28.5-Em-PNP-NO-M8x1

Warranty: 24 months following commissioning, but a maximum of 27 months following delivery

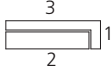
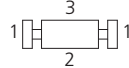

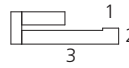
CS 12	1	< direct >	1,2
CS 16	1,3	< direct >	1,2
CS 20	1,3	VP 115	1,2
LM 20	1	VP 115	1,2
LM 25	1	VP 115	1,2
LM 32	1	VP 115	1,2
HM 10	1	< direct >	1,2
HM 16	1	< direct >	1,2
CR 16	3	< direct >	1,2
CR 20	3	< direct >	1,2
RM 16	3	VF 404	1,2
RM 25	3	VF 404	1,2
RM 32	3	VF 405	1,2
ES20	1,3	< direct >	1,2
ES30	3	VP 115	1
	3	VP 112	2
ES40	1	< direct >	1,2
ES40-HP	1	< direct >	1,2
SA-3	1,2	< direct >	1,2
SA-6	1,2	< direct >	1,2
RE-50	3	< direct >	1,2
SREH-50	3	direct	1
	3	VP 160	2
RA-40	3	VP	2
		50486391	

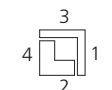
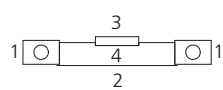
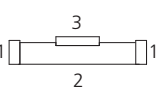

CS, ES	LM	HM	SA	UG, GM, SG, DG, PG, GE, SGE
				
PMP, PMP-c	PEZ, PDZ	PEL, PDL	RM, RE	CR, RM 32, RE, SREH, RA
				

Note that there might be different mounting positions from one module to another one.
The required connection elements and the range of support columns are depicted in the catalogue HT accessories.

Type	UG 25 NN
Max. static torque M_x	12 Nm
Max. static torque M_y	12 Nm
Max. static torque M_z	12 Nm
Max. dynamic torque M_x	0.12 Nm
Max. dynamic torque M_y	0.12 Nm
Max. dynamic torque M_z	0.12 Nm
Max. static force F	250 N
Max. dynamic force F	2.5 N

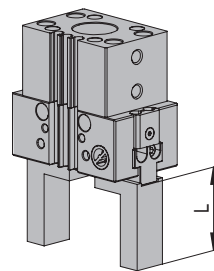
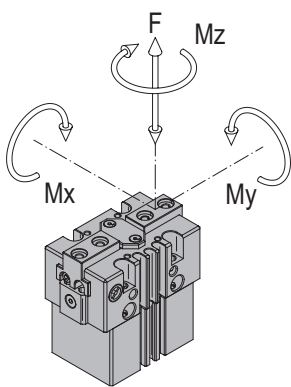

Finger length centric

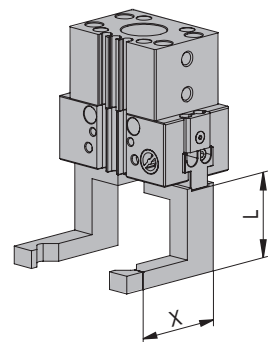

Finger length eccentric

Gripping force diagrams per jaw

Eccentric - UG 25 NN opening

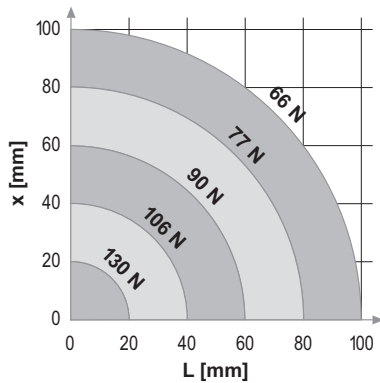

Eccentric - UG 25 NN closing

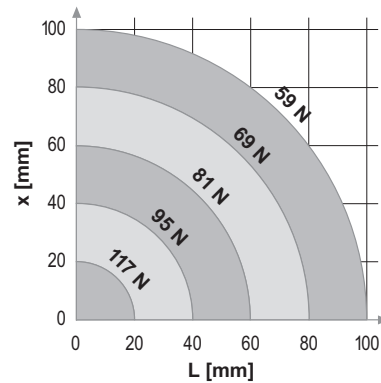

Centric - UG 25 NN opening

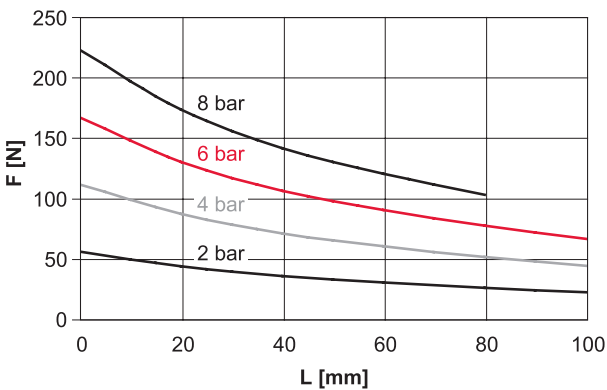

Centric - UG 25 NN closing

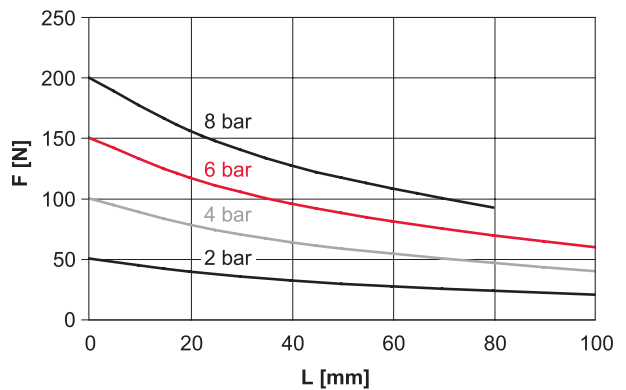

Eccentric - UG 25 NC closing

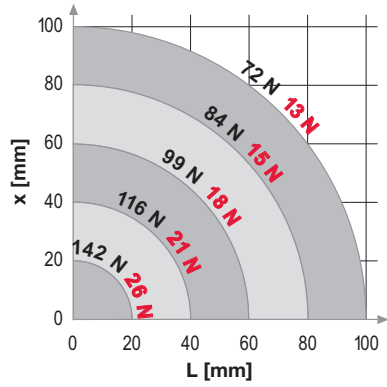

Centric - UG 25 NC closing

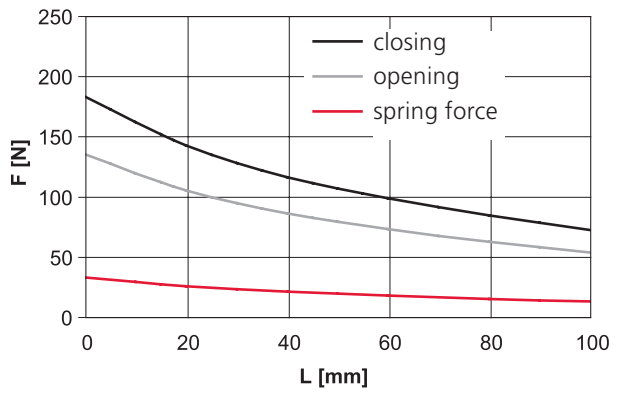

Eccentric - UG 25 NO opening

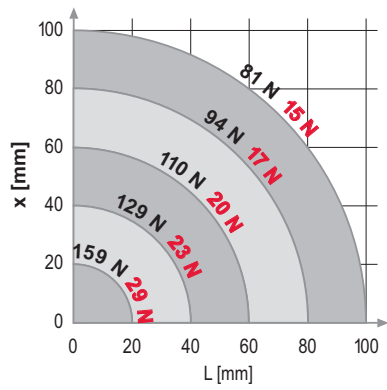

Centric - UG 25 NO opening

