



YARWAY HANCOCK CONTINUOUS BLOWDOWN GLOBE VALVE SERIES 5505

Advanced construction features of this high pressure drop angle globe valve provide quality and long service life.



FEATURES

- Rated to ASME 800 limited class for use in all applications requiring 800 limited class ratings or below.
- Available in 1" nominal pipe size with 1/8", 3/16", 1/4" or 5/16" orifice, depending on desired flow capacities.
- A micrometer dial position indicator allows fast, precise and repeatable settings.
- Socket weld end connections.
- Both disc and disc seat are hard faced with Stellite for erosion resistance.
- Seating surfaces are ground and lapped for tight shut off, eliminating double valving requirements.
- The integral stem disc is faced with stellite, then ground and lapped for accurate, leak-free sealing.
- The disc is tapered for maximum controllability over the full stroke of the valve.
- Standard material is carbon steel (ASME SA 105) body with 13% chrome stainless steel trim.
- One-piece drop forged body.
- Graphite packing, complete with braided graphite filament yarn anti-extrusion rings, is standard.
- All 5505 series valves comply with ASME B 16.34 and the ASME boiler and pressure vessel code, section 1.

GENERAL APPLICATION

In addition to continuous blowdown service, the Yarway high pressure drop valve is also used on feedwater bypass relief, sampling systems, drains and other services where erosion is extremely severe.

TECHNICAL DATA

Sizes: NPS 1
Available Types
5505W: Angle body, socket weld to ASME B16.11

YARWAY HANCOCK CONTINUOUS BLOWDOWN GLOBE VALVE

SERIES 5505

FEATURES

Specifically designed to withstand the deleterious effects of continuous blowdown service so damaging to conventional valves. The high velocity stream of boiler water, flashing into steam, is forced to expend its

kinetic energy within the confines of the diverging hardened stainless steel delivery tube, helping eliminate damage to the valve body wall and downstream piping

Large spoked handwheel – for ease of operation and locking.

ACME stem thread – for maximum strength, smooth, quick operation.

Stainless steel thread bushing – prevents wear and corrosion

Gland flange – forged steel, gland flange and separate gland are self aligning for straight line thrust against packing. No special tools required for packing adjustment.

High strength bonnet bolting – extra heavy hex head cap screws use standard tools for easy maintenance.

Integral bonnet and yoke – one-piece forging is made from ASME boiler and pressure vessel code, 1 section I listed materials.

Body-bonnet joint – metal-to-metal surface contact for automatic control of gasket compression and elimination of flange overstressing.

Forged body and bonnet – in full accordance with ASME boiler and pressure vessel code, section 1 design and material requirements.

Fixed back seat – positive, leak proof, packing chamber isolation. Fully machined for accurate seating.

Rugged one-piece stem/disc – precision ground and heat treated for maximum wear life.

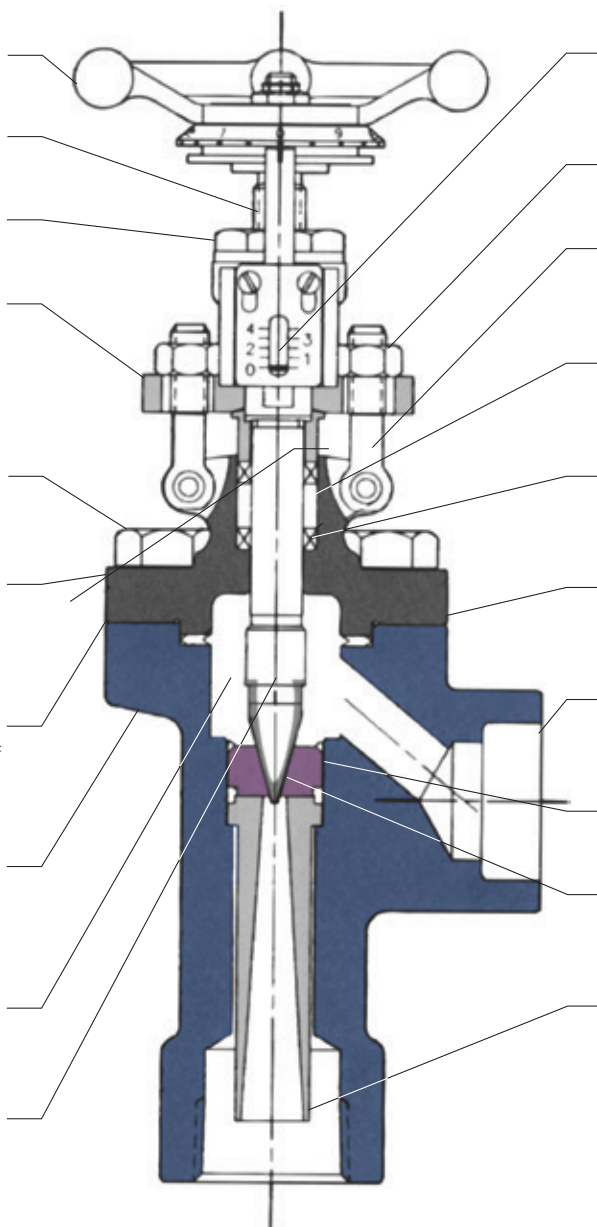

Micrometer dial indicator – fast, accurate positioning and repeatable flow control settings.

Standard hex gland nuts – can be adjusted with standard tools.

Swing bolts hardened pins – for ease of repacking. Pins are retained on both ends for maximum strength and safety.

Graphite packing – with built in corrosion inhibitor for leak tight sealing at high and low pressures and temperatures.

Non-extrusion rings – designed to prevent packing migration and ensure long service life in high pressure and temperature service.

Graphite filled stainless gasket – with controlled compression for maximum corrosion resistance and zero leakage.

End connections – in accordance with ASME B16.34 and are available in socket weld configurations.

Renewable, solid stellite seats – are standard.

Hard faced needle disc – precision ground for tight shutoff and maximum wear life.

Diverging delivery tube – precision ground and heat treated for maximum wear life in multiphase-flow and under cavitating conditions.

YARWAY HANCOCK CONTINUOUS BLOWDOWN GLOBE VALVE

SERIES 5505

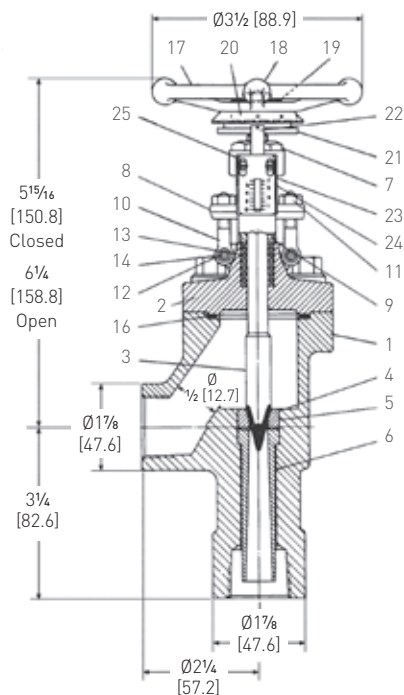

PARTS LIST

No.	Description	Material	Specifications
1	Body	Forged carbon steel	ASME SA105
2	Bonnet	Forged carbon steel	ASME SA105
3	Stem	Stainless steel	410 Condition T
4	Stem facing	Hard facing	Stellite or equal
5	Seat	Solid stellite	Stellite or equal
6	Tube	Stainless steel	347
7	Thread bushing	Stainless steel	410 Condition T
8	Packing gland flange	Carbon steel	ASTM A105
9	Packing gland	Stainless steel	410 Condition T
10	Packing gland bolt	Stainless steel	410 HT
11	Packing gland nut	Carbon steel	ASTM A194-2H
12	Pin	Stainless steel	410 HT
13	Packing ring	Compressed graphite	Corrosion inhibited
14	Bonnet bolt	Alloy steel	ASTM A193 Gr. B-7
16	Gasket	304 Stainless steel	Spiral wound graphite filled
17	Handwheel	Ductile iron	-
18	Handwheel nut	Carbon steel	Lock-type
19	Marker plate	Etched aluminum	-
20	Dial	Brass	-
21	Dial plate	Brass	-
22	Indicator	Brass	-
23	Indicator bracket	Aluminum	-
24	Indicator plate	Aluminum	-
25	Indicator plate	Screw brass	-

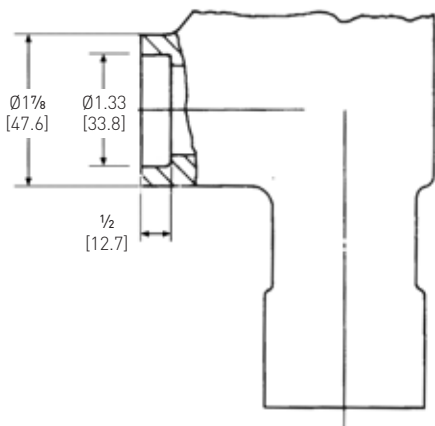

C_v VALUES BASED ON PERCENT OF OPENING

Percent open	Flow Coefficient C _v orifice size				Weight (lbs)
	1/8	3/16	1/4	5/16	
10	0.06	0.11	0.17	0.28	8.2
20	0.13	0.24	0.36	0.60	8.2
30	0.19	0.35	0.56	0.94	8.2
40	0.24	0.43	0.73	1.22	8.2
50	0.29	0.52	0.90	1.50	8.2
60	0.34	0.62	1.05	1.75	8.2
70	0.40	0.72	1.20	2.00	8.2
80	0.43	0.78	1.30	2.18	8.2
90	0.46	0.83	1.40	2.32	8.2
100	0.48	0.87	1.50	2.50	8.2

SOCKET WELD ENDS TO ASME B16.1
TYPE 5505W

NOTE:

Dimensions in inches [mm]

YARWAY HANCOCK CONTINUOUS BLOWDOWN GLOBE VALVE

SERIES 5505

CONTINUOUS BLOWDOWN CHART - WIDE OPEN

NPS 1 figure numbers 5505W wide open capacities vs. boiler pressures (reference #MM332)

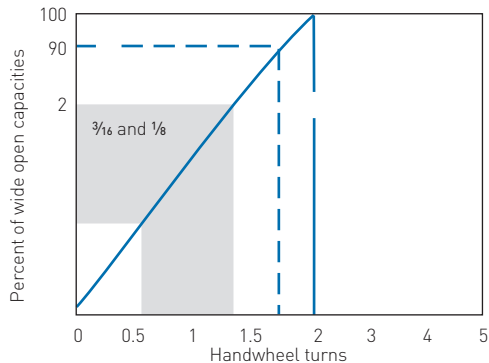
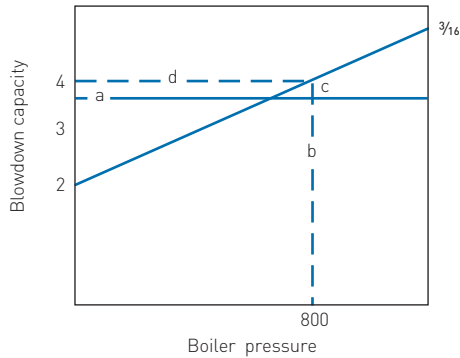
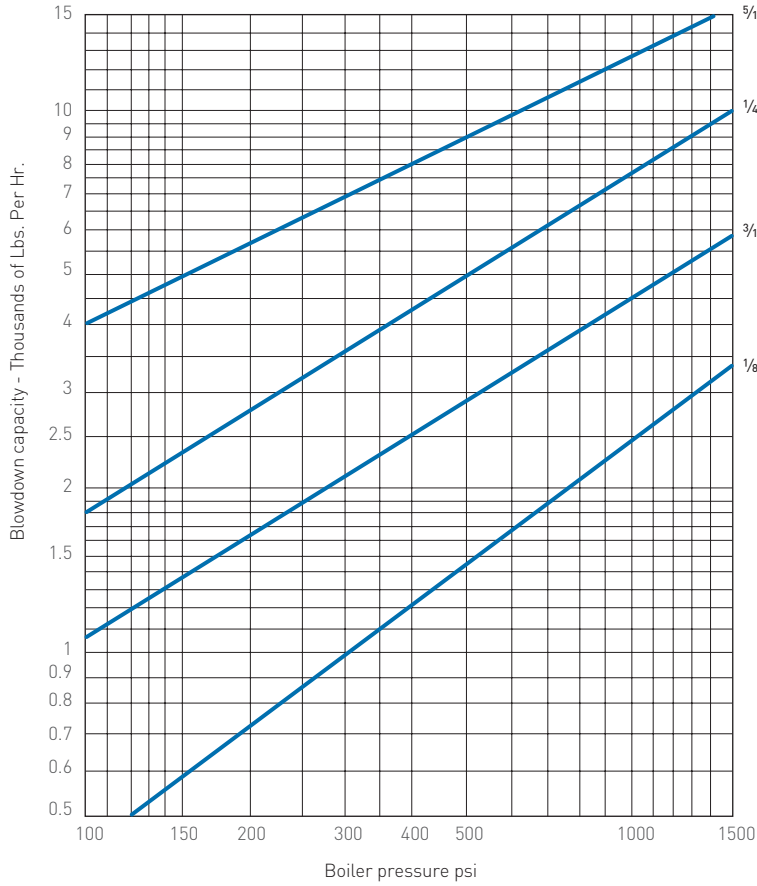

Example: To determine the correct size orifice for an class 800 continuous blowdown valve which will flow 3500 lbs/hr at 800 psig inlet pressure.

- On the continuous blowdown - Wide open chart to the right, locate 3,500 on the blowdown capacity scale and draw a horizontal line (a) across the chart from that point (see example below).
- Draw a vertical line (b) from 800 on the boiler pressure scale to intersect with the horizontal line (a).
- Continue the vertical line (c) until it intersects with the next higher orifice curve (in this case, 3/16").
- Draw a horizontal line (d) from the intersection of the 3/16" orifice curve to the blowdown capacity line and read the maximum capacity of the 3/16" orifice valve (3800 lbs/hr).
- Check to ensure that the selected orifice will result in the correct valve position to allow for proper control without throttling too close to the seat (see steps F - H).
- On the handwheel turns vs percent of wide open capacities chart (see page 5), locate the 3/16" orifice curve and draw a vertical line (e) from where it intersects with the 100% open line down to the handwheel turns scale. Read the number of turns to reach maximum capacity of the valve (2 turns).
- Determine what percent of the full open capacity is required to attain the normal required flow rate (divide the normal required flow rate by the maximum flow rate and multiply by 100 to obtain the correct percentage.) $3500/3800 \times 100 = 92\%$.
- Verify that the required flow rate will be obtained when the valve is between 1/3 and 2/3 open (in this case, between 0.66 and 1.33 full turns) by drawing a horizontal line (g) from the 92% point on the capacity scale to intersect with the 3/16" orifice curve. Then draw a vertical line (f) from that intersection to the handwheel turns scale and read the number of turns open (1.7) required to attain the specified flow (3500 lbs/hr).

Since 1.7 turns is much greater than the desired 1.33 and will result in little or no controllability, the next larger size orifice (1/4") should be utilized and the flow rate versus valve disc position reverified by repeating steps A through H.

YARWAY HANCOCK CONTINUOUS BLOWDOWN GLOBE VALVE

SERIES 5505

CONTINUOUS BLOWDOWN CHART - HANDWHEEL TURNS

NPS 1 figure numbers 5505W handwheel turn vs wide open capacities [reference #MM334]

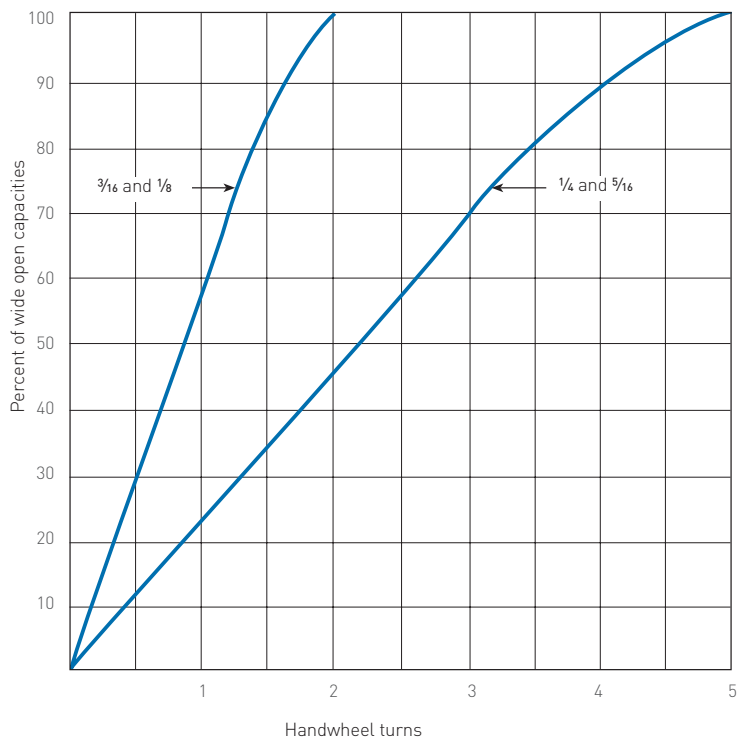

Steam, air, gas - Chart #1
(Reference #MM336)

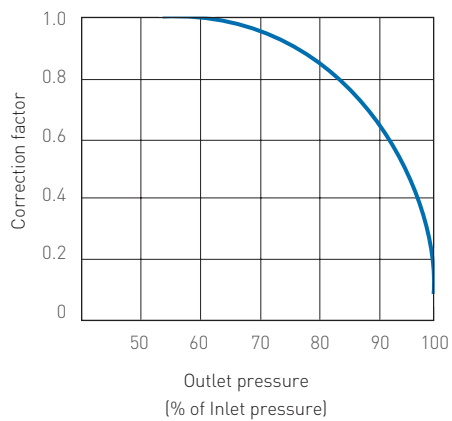

Steam- Chart #2
(Reference #MM336)

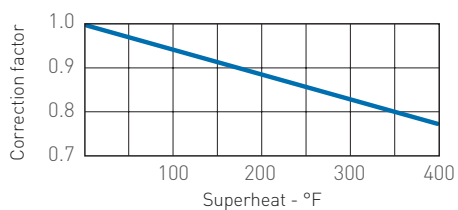

YARWAY HANCOCK CONTINUOUS BLOWDOWN GLOBE VALVE

SERIES 5505

WATER FLOW CHART

NPS 1 figure numbers 5505W (Reference #MM341)

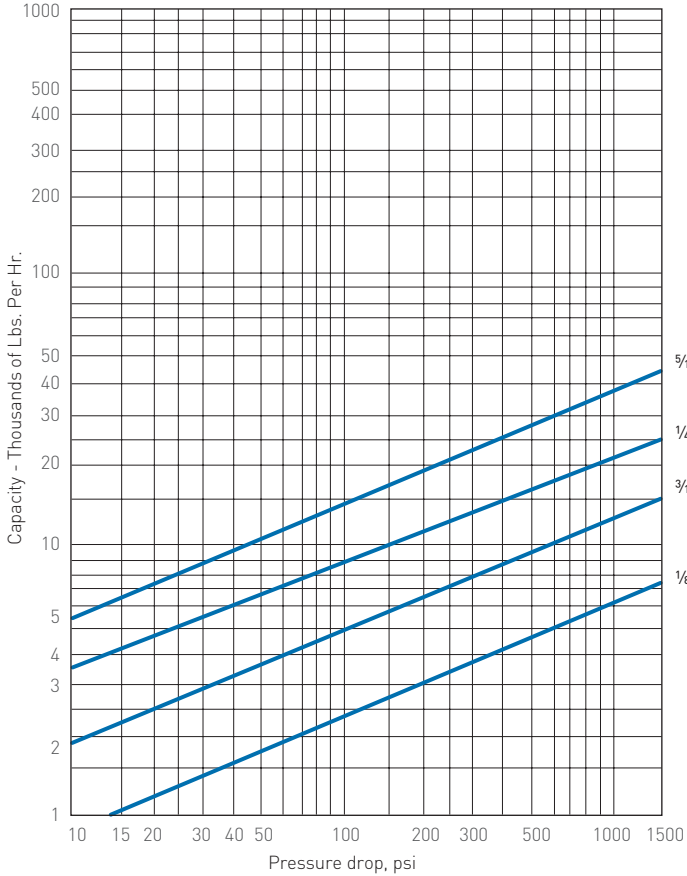

Example: To determine the correct size orifice for an 800 class continuous blowdown valve which will flow 6000 lbs/hr of water at 800 psig inlet pressure with a pressure drop of 400 psi:

- On the water flow chart to the right, locate 6000 on the capacity scale and draw a horizontal line (a) across the chart from that point (see sample chart below).
- Draw a vertical line (b) from 400 on the pressure drop scale to intersect with the horizontal line (a).
- Continue the vertical line (c) until it intersects with the next higher orifice curve (in this case, 3/16").
- Draw a horizontal line (d) from the intersection of the 3/16" orifice curve to the Capacity scale and read the maximum capacity of the 3/16" orifice valve (8800 lbs/hr).
- Check to ensure that the selected orifice will result in the correct valve position to allow for proper control without throttling too close to the seat (see steps F - H).
- On the handwheel turns vs percent of wide open capacities chart (see page 5), locate the 3/16" orifice curve and draw a vertical line (e) from where it intersects with the 100% open line down to the handwheel turns scale. Read the number of turns to reach maximum capacity of the valve (in this case, 2 turns).
- Determine what percent of the wide open capacity is required to attain the required flow rate. (divide the required flow rate by the maximum flow rate and multiply by 100 to obtain the correct percentage.)
 $6000/8800 \text{ lbs/hr} \times 100 = 68\%$
- Verify that the required flow rate will be obtained when the valve is between 1/3 and 2/3 open (in this case, between 0.66 and 1.33 full turns) by drawing a horizontal line (g) from the 68% point on the capacity scale to intersect with the 3/16" orifice curve. Then draw a vertical line (f) from that intersection down to the handwheel turns scale and read the number of turns open (1.2) required to attain the specified flow (6000 lbs/hr).

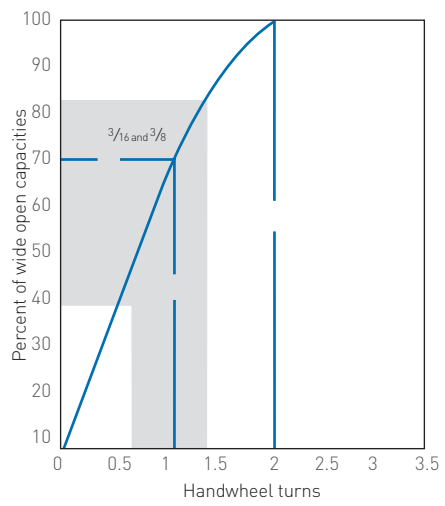
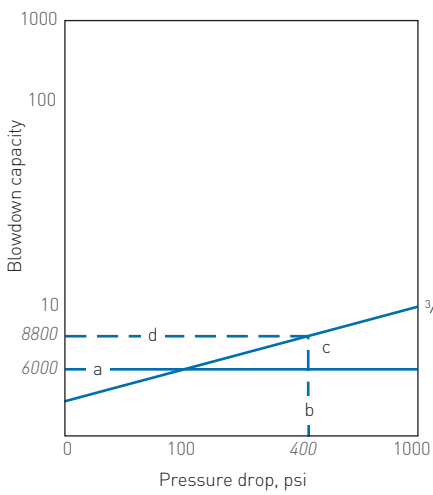

Since 1.2 turns falls between the optimum range of 0.66 and 1.33 turns, the 3/16" orifice is satisfactory for the application.

YARWAY HANCOCK CONTINUOUS BLOWDOWN GLOBE VALVE

SERIES 5505

STEAM FLOW CHART

NPS 1 figure numbers 5505W (Reference #MM342)

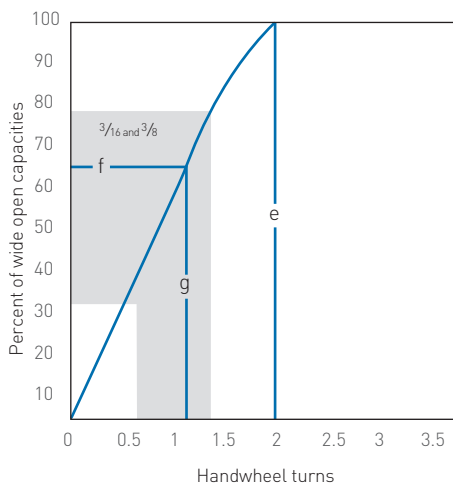
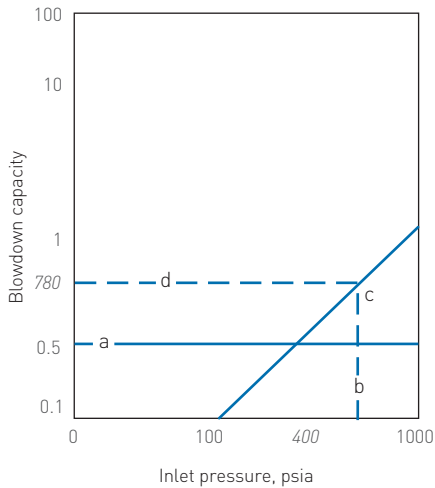
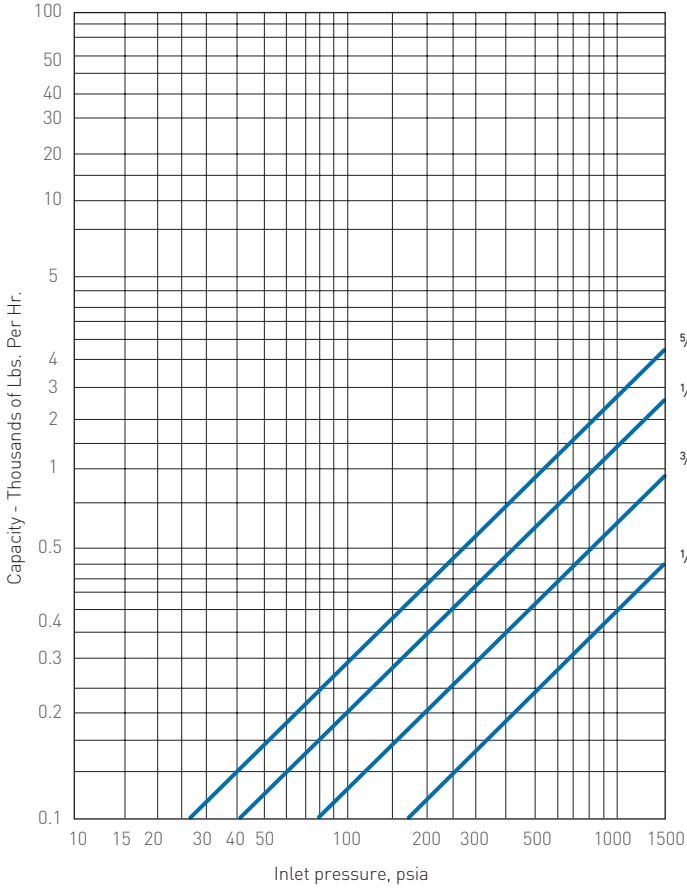

- Example: To determine the correct size orifice for an 800 class continuous blowdown valve which will flow 500 lbs/hr of steam at 600 psig inlet pressure with a pressure drop of 400 psi:
- On the steam flow chart to the right, locate 500 (0.5) on the capacity scale and draw a horizontal line (a) across the chart from that point (see sample chart below).
 - Draw a vertical line (b) from 600 on the Inlet pressure scale to intersect with the horizontal line (a).
 - Continue the vertical line (c) until it intersects with the next higher orifice curve (in this case, $\frac{3}{16}$ ").
 - Draw a horizontal line (d) from the intersection of the $\frac{3}{16}$ " orifice curve to the Capacity scale and read the maximum capacity of the $\frac{3}{16}$ " orifice valve (780 lbs/hr).
 - Check to ensure that the selected orifice will result in the correct valve position to allow for proper control without throttling too close to the seat (see steps F-I).
 - On the handwheel turns vs percent of wide open capacities chart (see page 5), locate the $\frac{3}{16}$ " orifice curve and draw a vertical line (e) from where it intersects with the 100% open line, down to the handwheel turns scale (see sample chart below, right). Read the number of turns to reach maximum capacity of the valve (in this case, 2 turns).
 - Calculate the percent of wide open capacity necessary to attain the desired flow rate (divide the required capacity by the maximum capacity): $500/780 \times 100 = 64\%$
 - Determine the number of turns open required to attain the required flow rate by drawing a horizontal line (f) from the 64% point on the percent of wide open capacities scale to intersect with the $\frac{3}{16}$ " orifice curve. Then draw a vertical line (g) from that intersection down to the handwheel turns scale. Read the number of handwheel turns needed to attain the desired flow (in this case, 1.20).
 - Verify that the disc will be positioned within the proper range (between $\frac{1}{3}$ and $\frac{2}{3}$ open, which in this case is between 0.66 and 1.33 full turns). Since 1.2 turns is well within the proper range of $\frac{2}{3}$ to $1\frac{1}{3}$ turns, the 1 inch valve with a $\frac{3}{16}$ " diameter orifice is satisfactory for the application and will allow for good control, both above and below the specified flow rate, without getting the disc too close to the seat.

YARWAY HANCOCK CONTINUOUS BLOWDOWN GLOBE VALVE

SERIES 5505

FLOW CALCULATION DATA AND FORMULAS

The required valve size, flow rate or differential pressure can be determined from the nomographs on pages 4 through 7, or through the use of the formulas below. Flow Coefficients (C_v) can be found on page 3. When determining the required valve size either through the use of flow coefficients (C_v) or the graphic method, it should be noted that the resultant valve size is the size that will give the required flow (or C_v) in the full open position. For optimum controllability, a control valve should be sized using a 25% greater flow capacity than the maximum required for the desired operating conditions. Selection of a valve on this basis allows for control variations above and below the calculated flow rate.

NOTE: For gas or steam, the maximum differential pressure (P) cannot exceed $\frac{1}{2} P_1$ - (Minimum $P_2 = \frac{1}{2} P_1$)

The formulas shown may be used to calculate valve capacities or required flow coefficients.

Where:

- C_v = Valve flow coefficient
- P_1 = Inlet pressure (psia)
- P_2 = Outlet pressure (psia)
- ΔP = Pressure drop (psi)
- G = Specific gravity of liquid (water = 1.0)
- $T_{[sh]}$ = Superheat °F = Total °F - Saturated °F
- G_g = Specific gravity of gas (air @ one atm and 60°F = 1.0)
- T = Absolute temperature upstream of flowing medium (0°F + 460)
- Q = U.S. gallons per minute = Mass flow rate in pounds per hour
- Q_g = Flow rate of gas or vapor in standard cubic feet per hour
- W = Mass flow rate in pounds per hour

Liquids:

$$Q = C_v \sqrt{\frac{\Delta P}{G}} \quad \text{OR} \quad C_v = \frac{Q}{\sqrt{\frac{\Delta P}{G}}}$$

Saturated steam:

$$W = 2.1 C_v \sqrt{\Delta P(P_1 + P_2)} \quad \text{OR} \quad C_v = \frac{W}{2.1 \sqrt{\Delta P(P_1 + P_2)}}$$

Superheated steam:

$$W = \frac{2.1 C_v}{1 + 0.0007T_{[sh]}} \sqrt{\Delta P(P_1 + P_2)} \quad \text{OR} \quad C_v = \frac{W [1 + 0.0007T_{[sh]}]}{2.1 \sqrt{\Delta P(P_1 + P_2)}}$$

Gas:

$$Q_g = 1360 C_v \sqrt{\frac{\Delta P}{G_g T}} \sqrt{\frac{(P_1 + P_2)}{2}} \quad \text{OR} \quad C_v = \frac{Q_g}{1360 C_v \sqrt{\frac{\Delta P}{G_g T}} \sqrt{\frac{\Delta P(P_1 + P_2)}{2}}}$$

When ordering Yarway valves, please specify:

- A. Quantity required
- B. Valve type
- C. Type of connection - Socket weld
- D. Operating conditions
 - Working pressure
 - Temperature
 - Flow rate
 - Differential pressure
- E. Size of connection - 1"
- F. Valve style - Bolted bonnet OS&Y
- G. Body material
- H. Trim material
- I. Orifice diameter

Example: 3 each, NPS 1 Yarway figure No. 5505W-2 High pressure drop control Valve, ASME 800 Class, manually operated, OS&Y, bolted bonnet, with solid Stellite seat ring, ASME SA105 body and bonnet and hard faced, 13% Cr. trim. End connections shall be socket weld. Valve must meet the requirements of ASME B16.34, Section 1 of the ASME Boiler & Pressure vessel code and be suitable for use in the following service conditions:

Operating conditions:

Fluid = _____ at _____ psig and _____ °F;

Required flow rate = _____ lbs/hr.

Design conditions: Fluid = _____ psig and °F;

Design flow rate = _____ lbs/hr.

TYPICAL SPECIFYING SEQUENCE

Example	1	5505	W	-000	¼
Nominal valve size NPS					
1					
Valve type number					
5505 - High pressure drop globe valve, angle body, solid Stellite seat					
End connection					
W - Socket end					
Material combination suffix					
No suffix indicates standard materials (SA 105 body, stainless trim)					
Seat orifice size					
¼, ⅜, ½, ⅝					