

EMERSON WIRELESS 1410S2 GATEWAY

| REVISION TABLE | | | |
|------------------------------|------------|----------|--------|
| REVISION | ECO NO. | APP'D | DATE |
| AC | RTC1078992 | JIMMY JI | 4/8/22 |
| DESCRIPTION | | | |
| ADD 1410S1 GATEWAY ON PAGE 3 | | | |

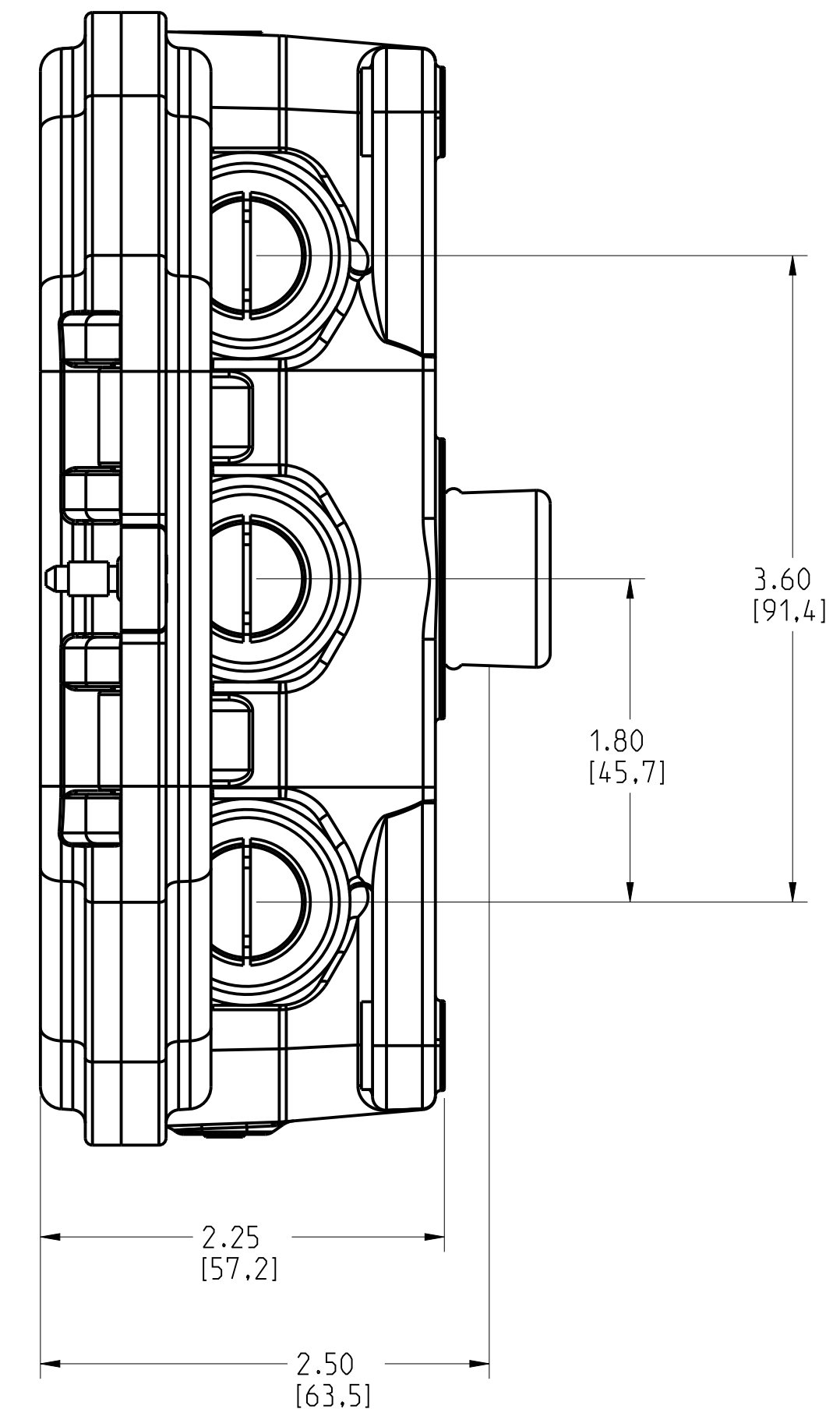
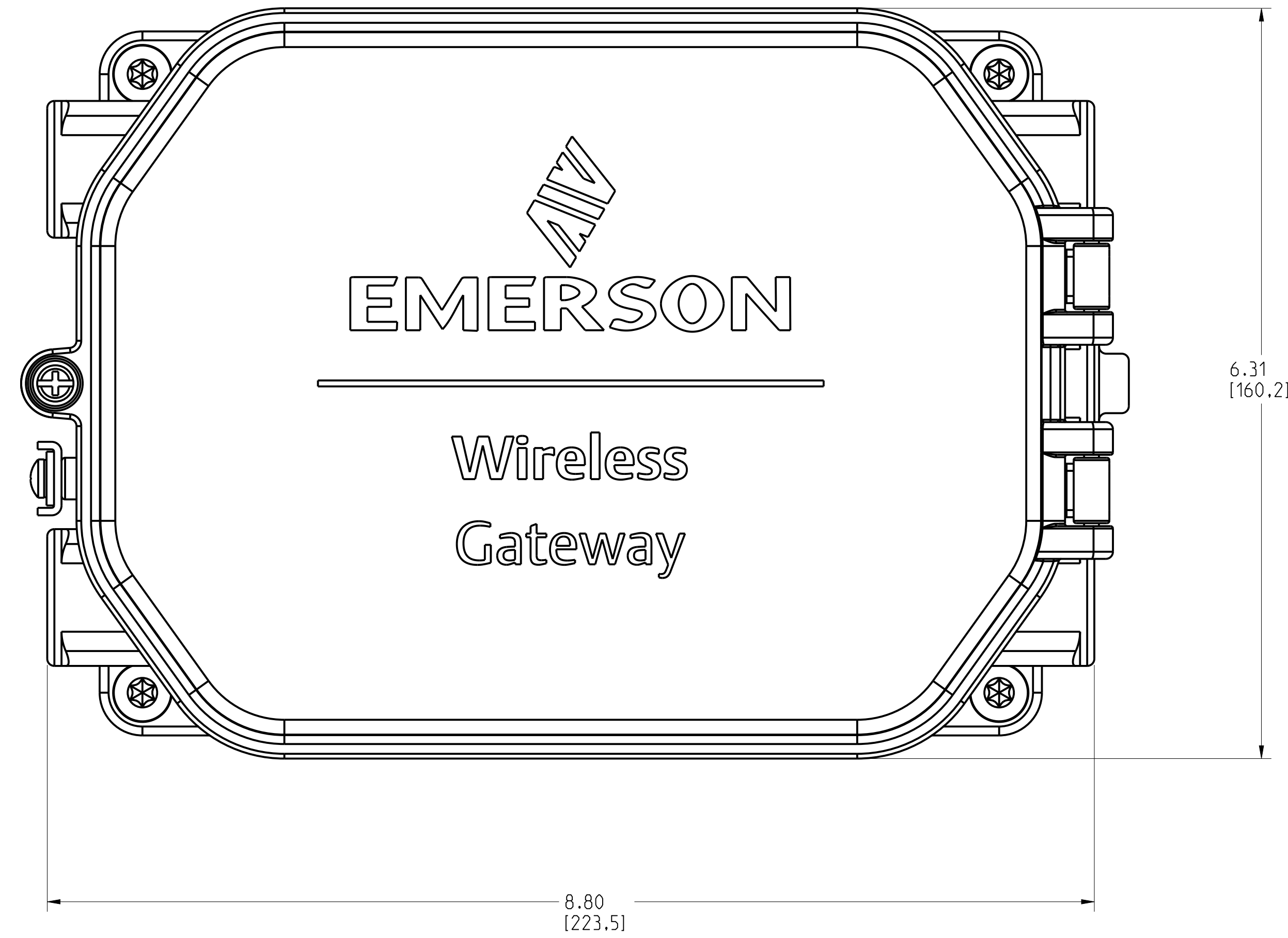

©2015 ROSEMOUNT, INC.
ROSEMOUNT INC. EXPRESS
THIS DRAWING IS TO BE USED
IN ACCORDANCE WITH
ROSEMOUNT ENGINEERING
SPECIFICATIONS.
UNIT NOTES IN INCHES (mm).

REFERENCE ROSEMOUNT
PRODUCT SPECIFICATIONS FOR
PRODUCT SPECIFICATIONS.
CLICK HERE

3RD ANGLE

SIZE D SCALE NTS

EMERSON

TITLE
**ROSEMOUNT 1410S
TYPE I DRAWING**

DR. J. ARMSTRONG 10/22/19 DRAWING NO. 01410-7001
APP'D J.SMEDRUD 10/23/19

CAD MAINTAINED. (PRO/E) SHEET 1 OF 3

EMERSON WIRELESS 1410S2 GATEWAY MOUNTING CONFIGURATION

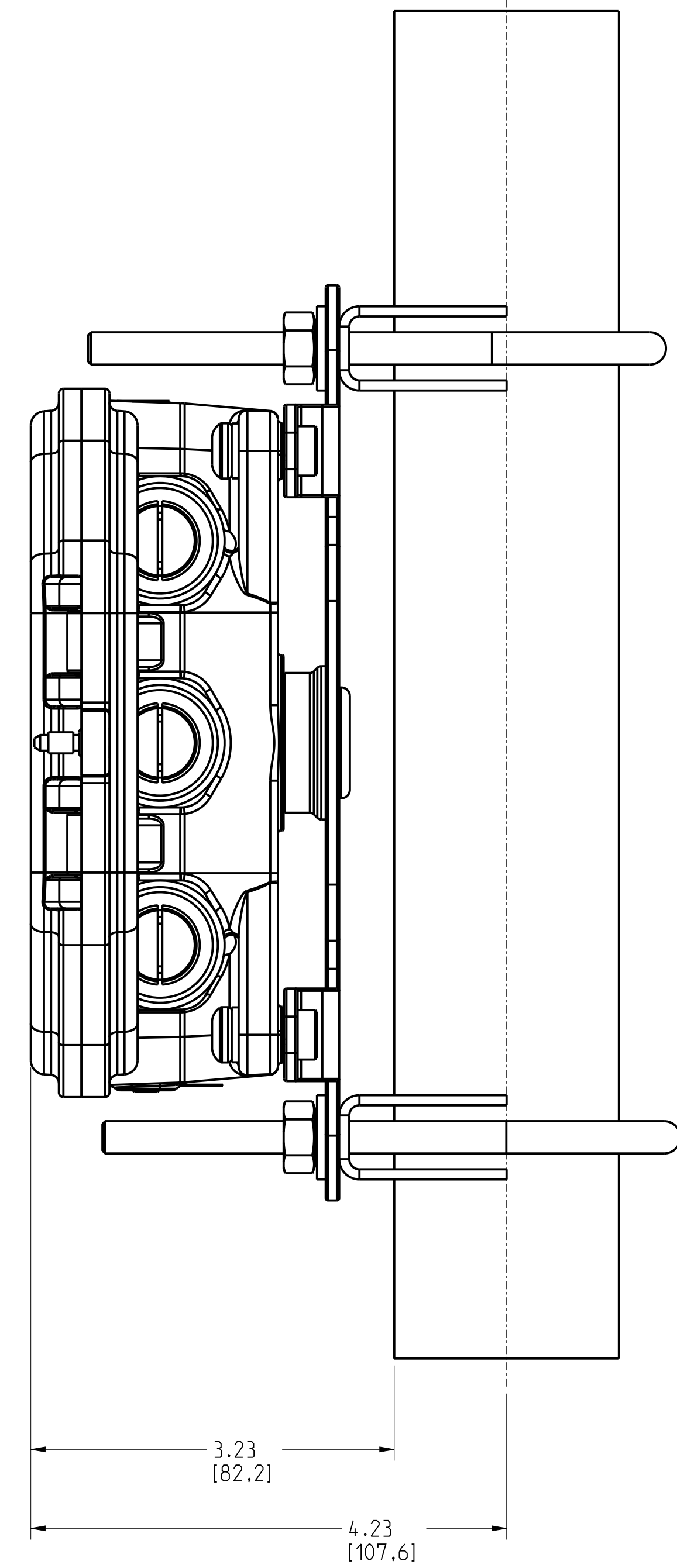
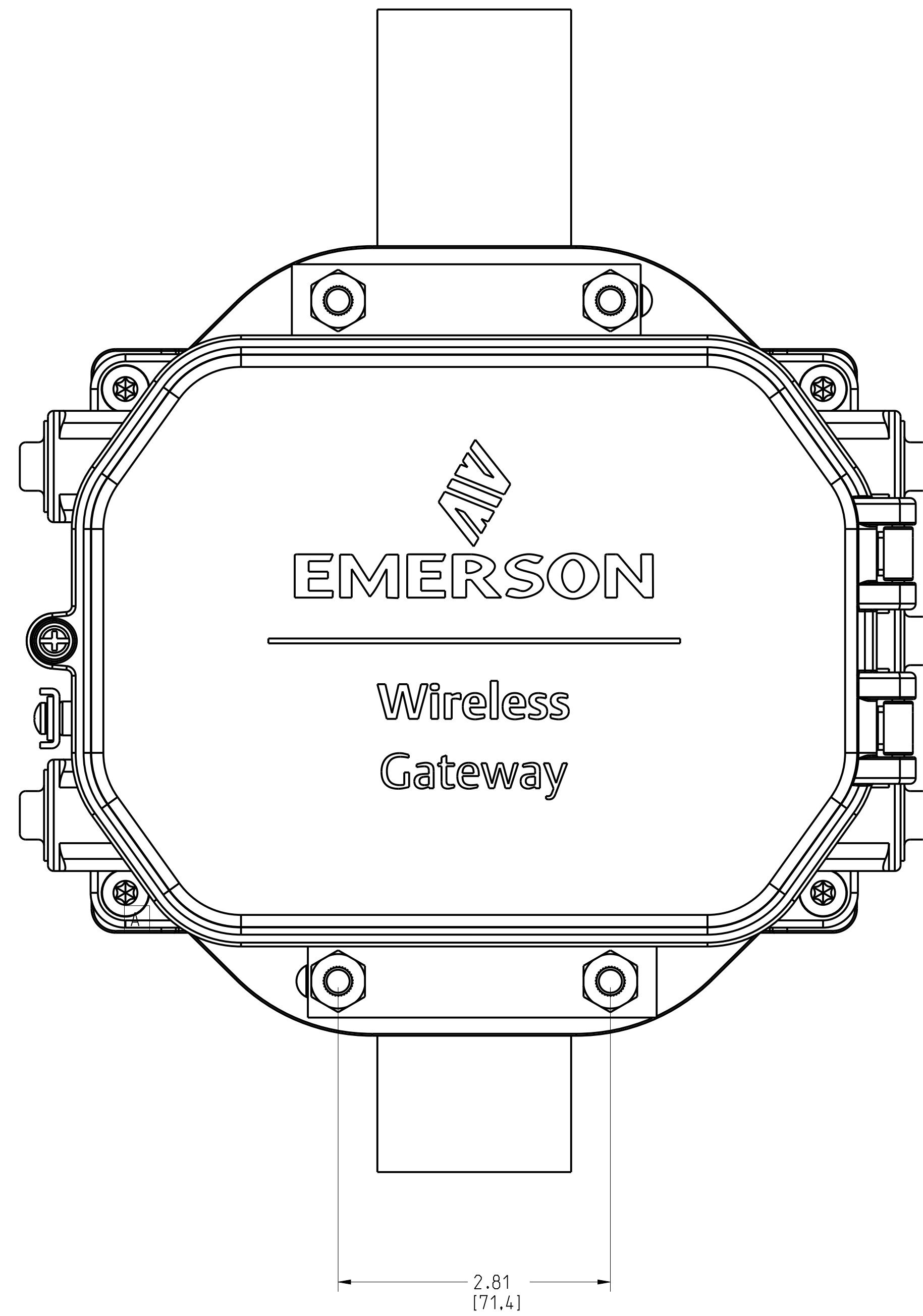

©2015 ROSEMOUNT, INC.
ROSEMOUNT INC. EXPRESSLY
DISCLAIMS LIABILITY FOR
THIS DRAWING AND ASSUMES NO
RESPONSIBILITY FOR
ROSEMOUNT ENGINEERING
SPECIFICATIONS.
UNIT NOTES IN INCHES (mm).

REFERENCE ROSEMOUNT
PRODUCT SHEETS FOR
PRODUCT SPECIFICATIONS.
CLICK HERE

DR. J. ARMSTRONG 10/22/19 DRAWING NO. 01410-7001
APP'D J.SMEDRUD 10/23/19
CAD MAINTAINED. (PRO/E)

3RD ANGLE

EMERSON

TITLE
ROSEMOUNT 1410S
TYPE I DRAWING

SIZE D SCALE NTS

SHEET 2 OF 3

EMERSON WIRELESS 1410S1 GATEWAY

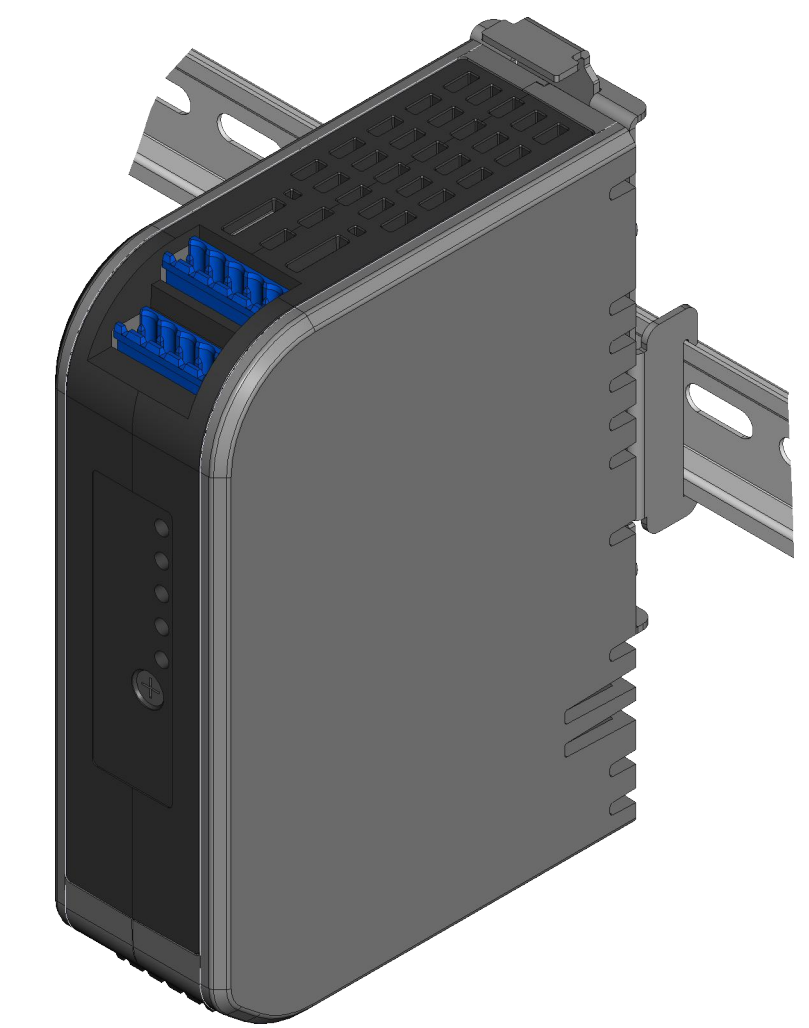
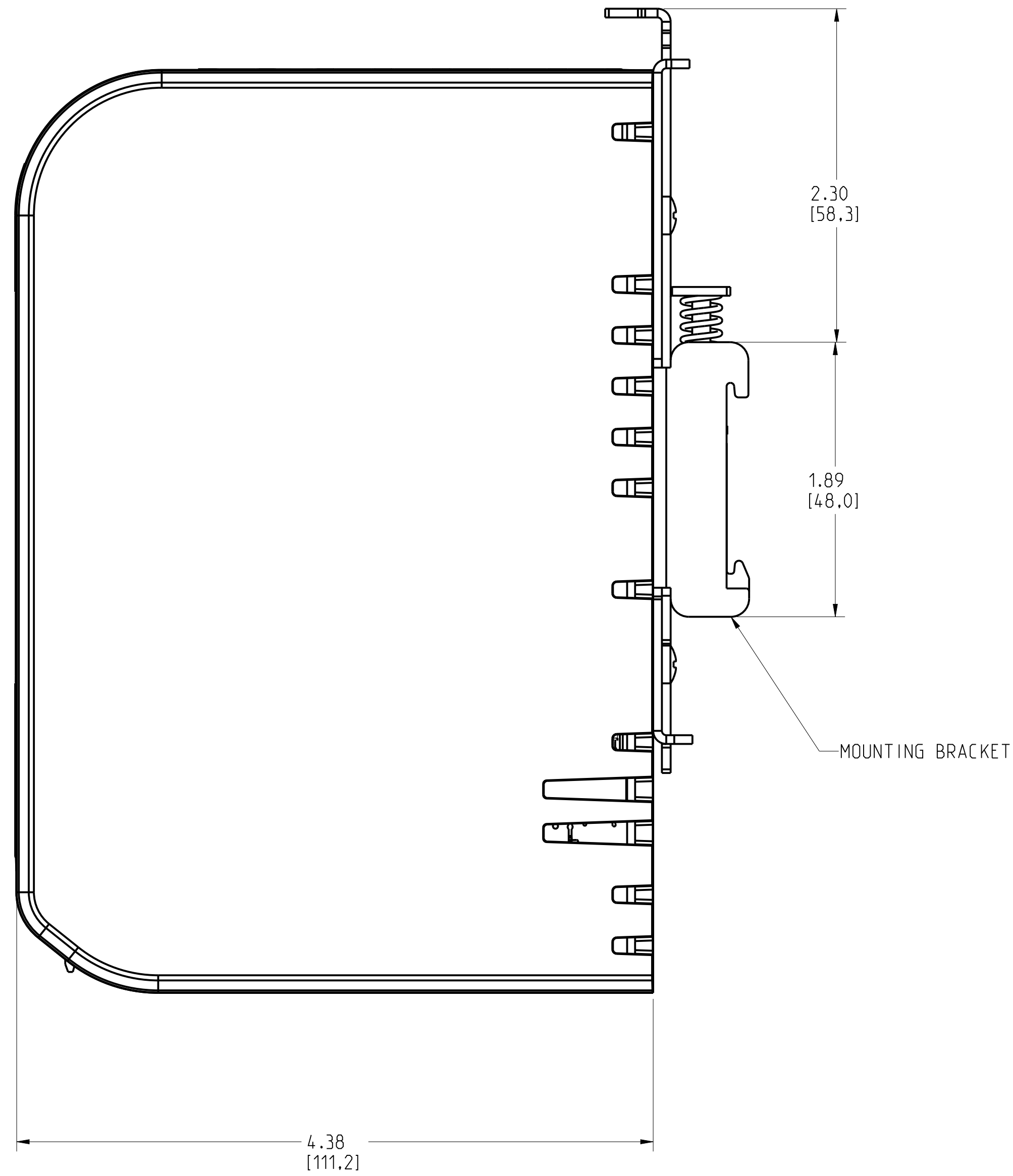
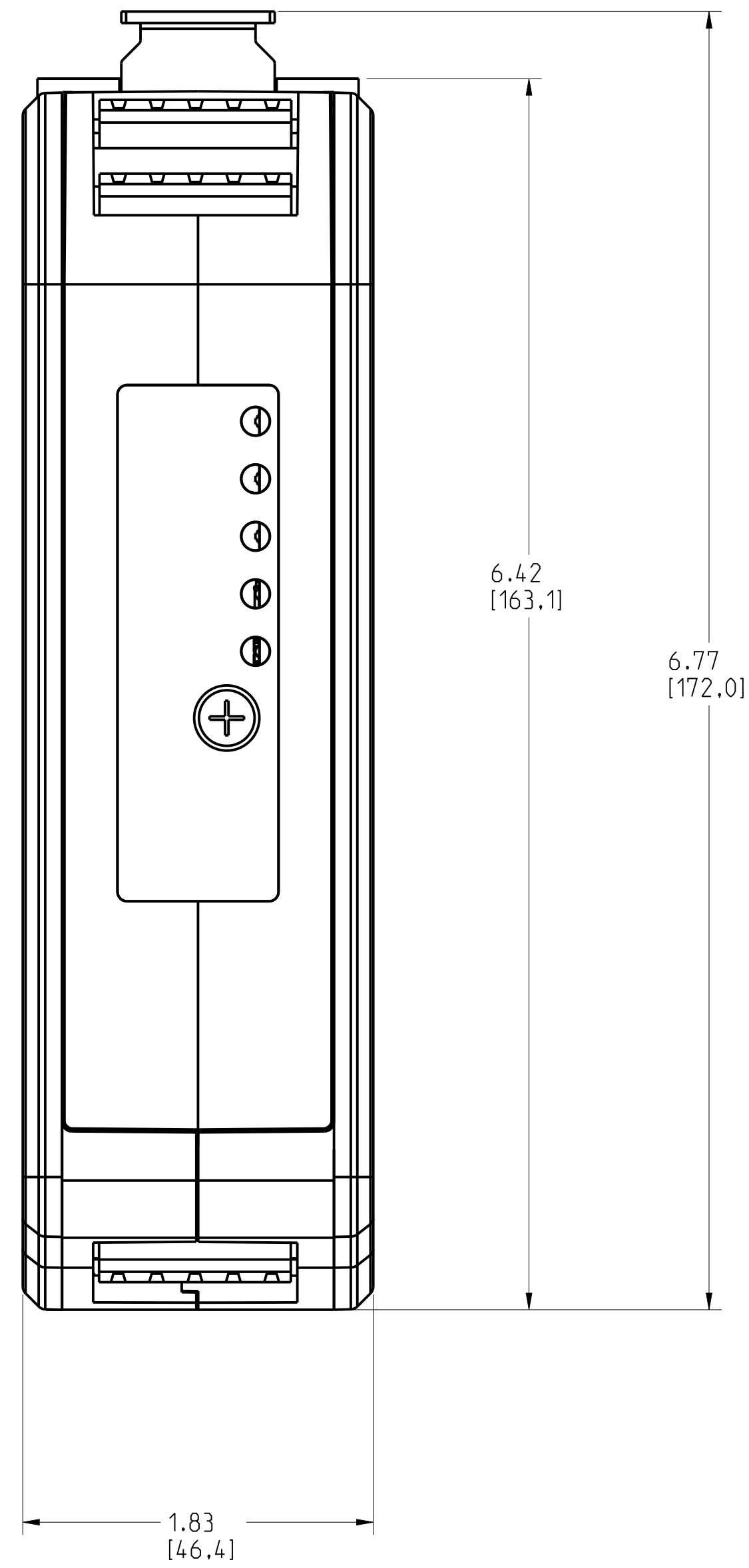

DIN RAIL MOUNTING

Wire connectors for antenna and power (not shown).

| | | | | | | | |
|--|--|-------------|-----------|------------|------|--------------|--|
| <small>©2015 ROSEMOUNT, INC. ROSEMOUNT INC. ACCEPTS THIS DRAWING AS A COPY IN ACCORDANCE WITH ROSEMOUNT ENGINEERING SPECIFICATIONS. UNIT NOTES IN INCHES (mm). REFERENCE ROSEMOUNT PRODUCT SPECIFICATIONS FOR PRODUCT SPECIFICATIONS. CLICK HERE</small> | SCALE | 7/10 | 3RD ANGLE | | SIZE | SCALE | |
| | | | | | D | NTS | |
| | EMERSON | | | | | | |
| | TITLE ROSEMOUNT 1410S TYPE I DRAWING | | | | | | |
| DR. J. ARMSTRONG 10/22/19 | | DRAWING NO. | | 01410-7001 | | | |
| APP'D J.SMEDRUD 10/23/19 | | | | | | | |
| CAD MAINTAINED (PRO/E) | | | | | | SHEET 3 OF 3 | |