

Type 119

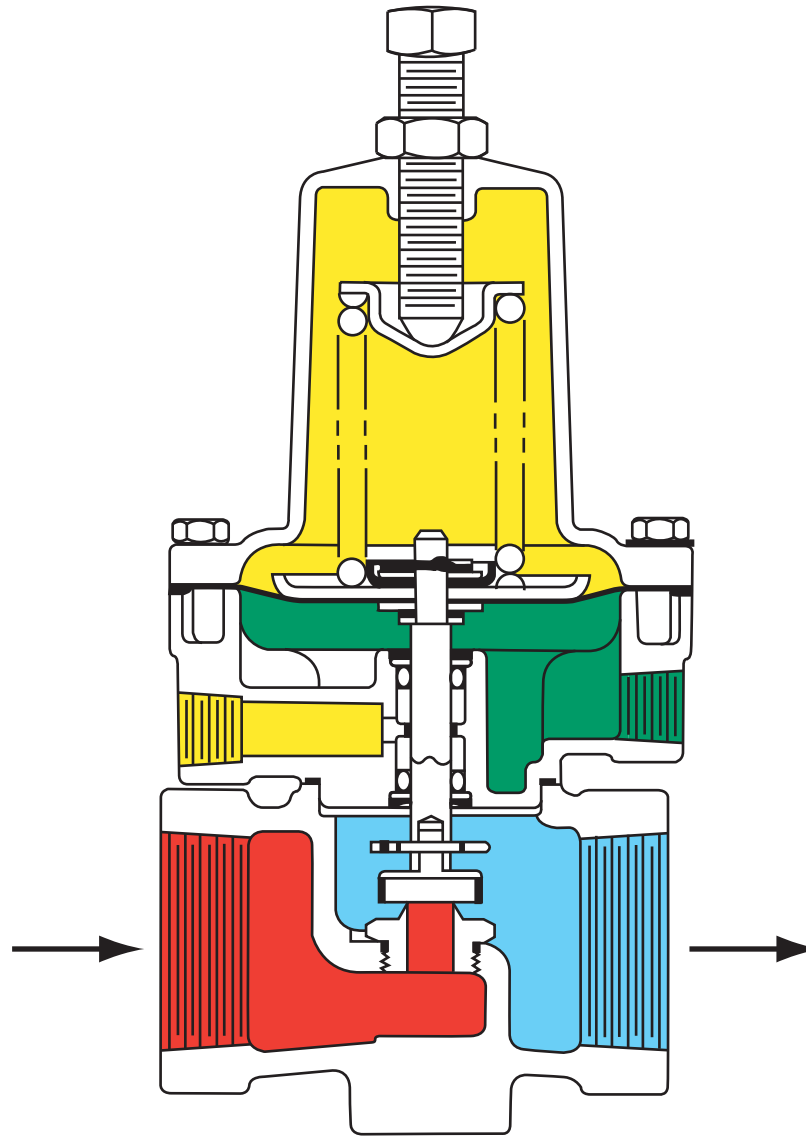

- INLET PRESSURE
- OUTLET PRESSURE
- ATMOSPHERIC PRESSURE
- LOADING PRESSURE