

<b>ASCO™</b>	INSTALLATION AND MAINTENANCE INSTRUCTIONS	EN
	INSTRUCTIONS D'INSTALLATION ET DE MAINTENANCE	FR
	INBETRIEBNAHME - UND WARTUNGSANLEITUNG	DE
	INSTRUCCIONES DE PUESTA EN MARCHA Y MANTENIMIENTO	ES
	ISTRUZIONI DI MESSA IN SERVIZIO E MANUTENZIONE	IT
	ALGEMENE INSTALLATIE- EN ONDERHOUDSINSTRUCTIES	NL
	INSTALLASJONS- OG VEDLIKEHOLDSINSTRUKSER	NO
	INSTALLATIONS- OCH UNDERHÅLLSINSTRUKTIONER	SE
	ASENNUS - JA HUOLTO-OHJEET	FI
	INSTALLATIONS - OG VEDLIGEHOUDSANVISNINGER	DK
	INSTRUÇÕES DE INSTALAÇÃO E MANUTENÇÃO	PT
	ΟΔΗΓΙΕΣ ΤΟΠΟΘΕΤΗΣΗΣ ΚΑΙ ΣΥΝΤΗΡΗΣΗΣ	GR
	POKYNY PRO INSTALACI A ÚDRŽBU	CZ
	INSTRUKCJA MONTAŻU I KONSERWACJI	PL
	TELEPÍTÉSI ÉS KARBANTARTÁSI ÚTMUTATÓ	HU
	Инструкция по установке и обслуживанию	RU
МОНТАЖДАУ ЖӘНЕ ҚЫЗМЕТ КӨРСЕТУ НҰСҚАУЛАР	KZ	
설치 및유지 관리 지침	KR	

# 290

## proportional motorised valve



**NBR / PBT «K»**

24 V DC ≡

E290CP-V0K4MAV1

E290CP-V0K00VV1



**FPM / 316L «X»**

24 V DC ≡

E290CP-V0X4MAV1

E290CP-V0X00VV1

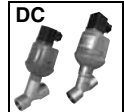
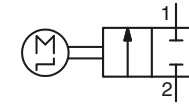

**NBR / PBT «K» - FPM / 316L «X»**

ACTUATING TIME

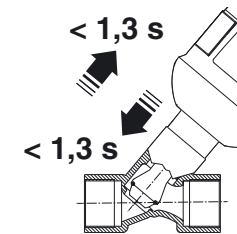

FLOW

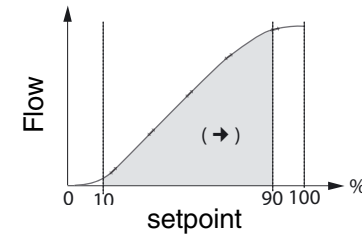

(→) Recommended working area

- Linearity ±5%
- hysteresis < 5%
- accuracy < 3%
- sensitivity < 3%
- repeatability < 3%

514362-001 / A  
Availability, design and specifications are subject to change without notice. All rights reserved.

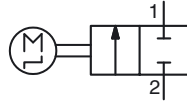

NBR / PBT «K»

PMA (Max. allowable pressure) 10 bar max.					
flow coefficient Kv	operating pressure differential (bar)		min.		
	max.	air	water	oil	
<b>NBR / PBT «K»</b>					
3/8	2,7	45	0	6	
1/2	3,8	63	0	5	
3/4	6	100	0	4	

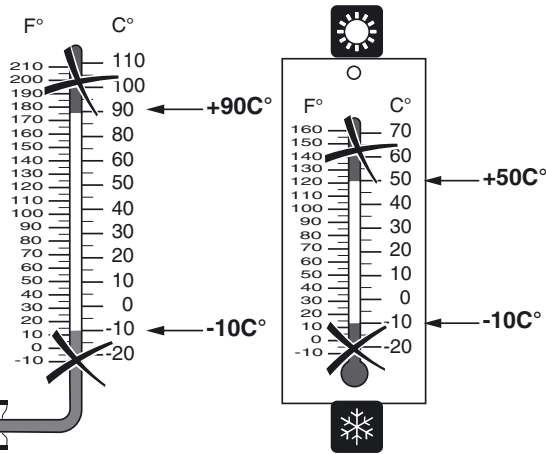

RECOMMENDATION FOR MAXIMUM DUTY CYCLE

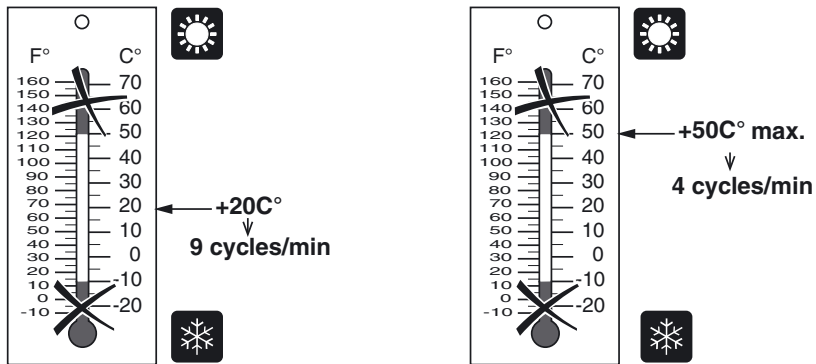

OPERATING CONDITIONS

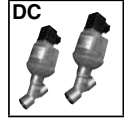
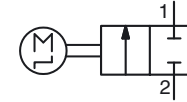

FPM / 316L «X»

PMA (Max. allowable pressure) 10 bar max.					
flow coefficient Kv	operating pressure differential (bar)		min.		
	max.	air	water	oil	steam
<b>FPM / 316L «X»</b>					
3/8	2,7	45	0	6	4
1/2	3,8	63	0	5	4
3/4	6	100	0	4	4

RECOMMENDATION FOR MAXIMUM DUTY CYCLE

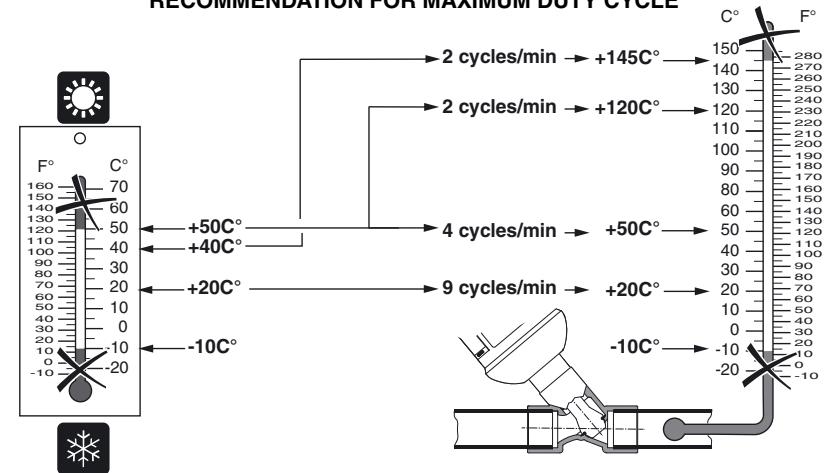

OPERATING CONDITIONS

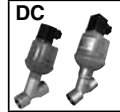
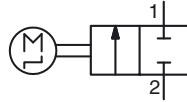

**24 V ±10 % DC**  
**(NBR / PBT «K» / FPM / 316L «X»)**



MOUNTING «K» + «X»

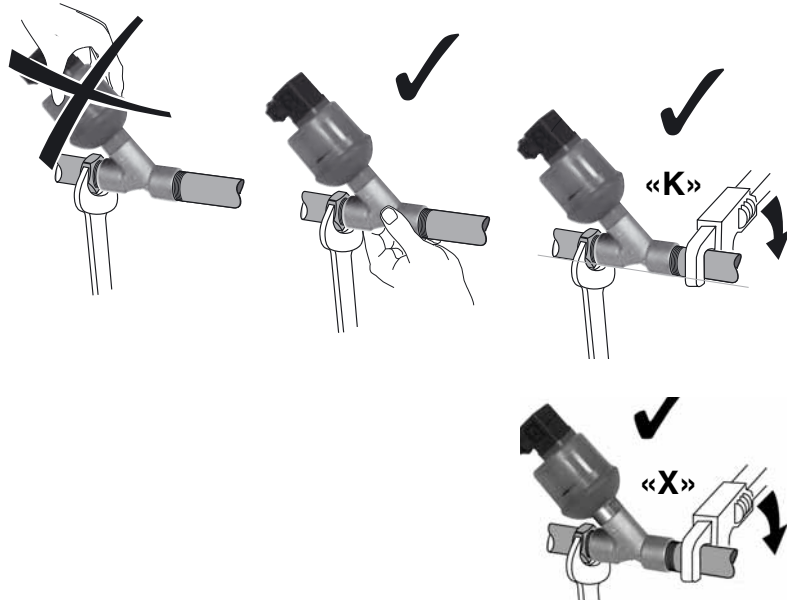

1	24 V / DC
2	0 V
3	setpoint (0-10 V or 4-20 mA)
4	feedback signal [24 V switch]

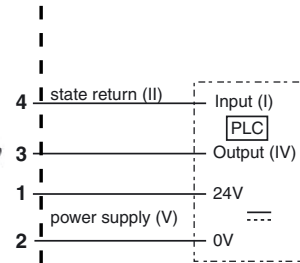
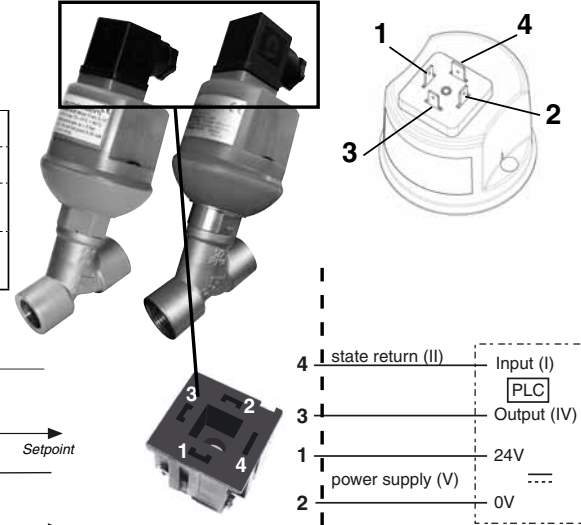
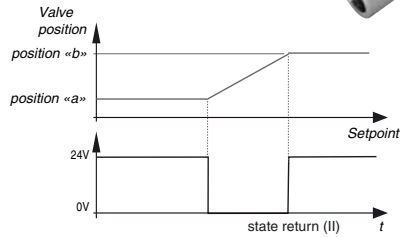

	FR	DE	ES	IT
(I)	entrée	Eingang	entrada	input
(II)	signal de retour	Stellungsrückmeldung	Retorno de estado	ritorno
(IV)	sortie	Ausgang	salida	output
(V)	alimentation électrique	Spannungsversorgung	Alimentación eléctrica	Alimentazione elettrica

	NL	PT	RU	KZ
(I)	input	entrada	вход	кіріс
(II)	terugkeer naar stand	retorno de estado	возврат состояния	күйді қайтару
(IV)	output	saída	выход	шығыс
(V)	voeding	alimentação elétrica	источник питания	қуат көзі



**24 V ±10 % DC**  
 (NBR / PBT «K» / FPM / 316L «X»)



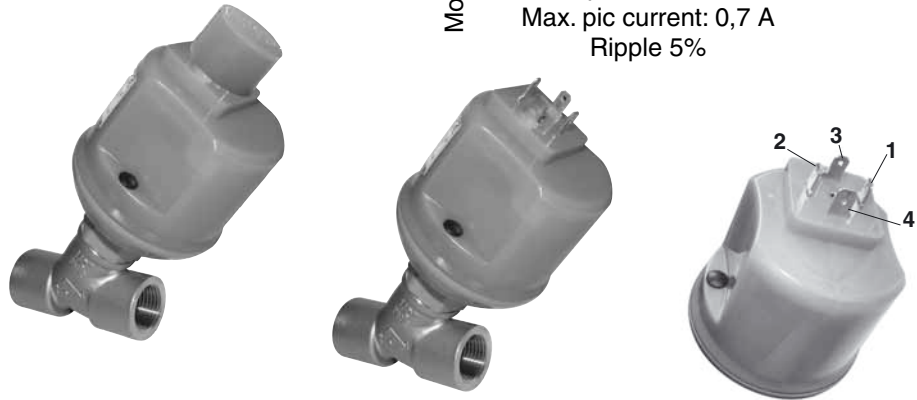

Motor 12 W in operation, < 2 W hold  
 Max. pic current: 0,7 A  
 Ripple 5%

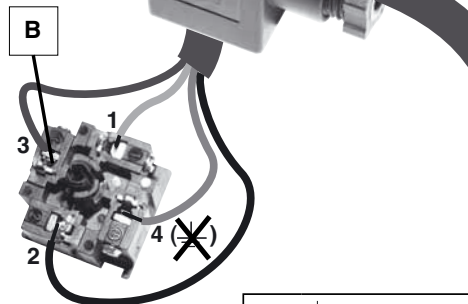
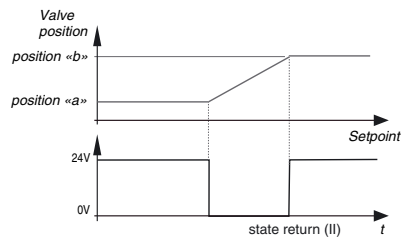

(ISO 4400 / EN 175301-803, form A)

1	24 V / DC
2	0 V
3	setpoint (0-10 V or 4-20 mA)
4	feedback signal [24 V switch]

items	N.m	Inch.pounds
<b>B</b>	0,4 ±0,05	3,2 ±0,4



**24 V ±10 % DC**  
 (NBR / PBT «K» / FPM / 316L «X»)

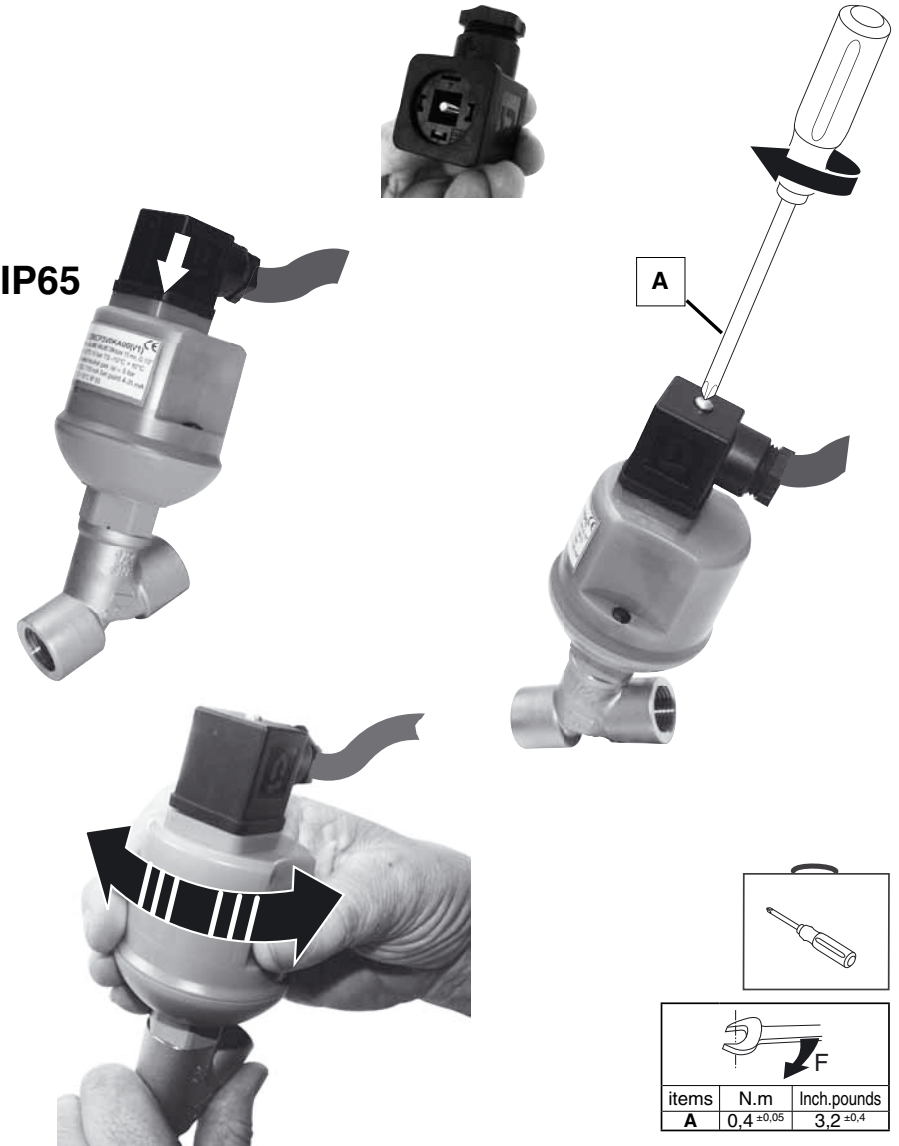
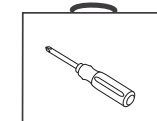

IP65

items	N.m	Inch.pounds
<b>A</b>	0,4 ±0,05	3,2 ±0,4

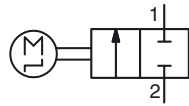

INIT PHASE	EN	PHASE D'INITIALISATION	FR	INITIALISATIONS PHASE	DE
FASE INICIACIÓN	ES	FASE DI INIZIALIZZAZIONE	IT	INITIALISATIEFASE	NL
FASE INICIAL	PT	НАЧАЛЬНЫЙ ЭТАП	RU	БАСТАПҚЫ ФАЗА	KZ

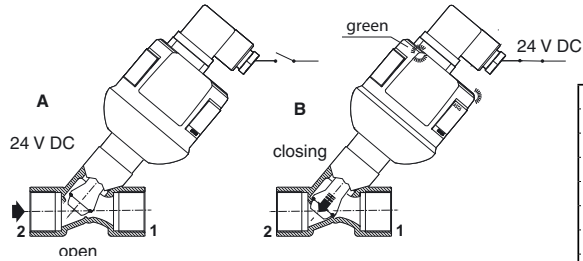

	A	B
FR	ouvert	fermeture
DE	Öffnen	Schließen
ES	apertura	cierre
IT	apertura	chiusura
NL	openen	sluiten
PT	abertura	fecho
RU	открытие	закрытие
KZ	ашу	жабу

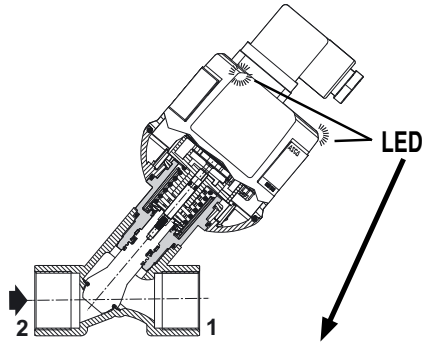

LED				
	valve OPEN	valve CLOSED	valve MOVES TO OPEN	valve MOVES TO CLOSE
EN	green	orange	green flashing	green flashing
FR	verte	orange	verte clignotante	verte clignotante
DE	grün	orange	grün blinkend	grün blinkend
ES	verde	naranja	verde intermitente	verde intermitente
IT	verde	arancione	verde lampeggiante	verde lampeggiante
NL	groen	oranje	groen knipperend	groen knipperend
PT	verde	laranja	verde intermitente	verde intermitente
RU	зеленый	оранжевый	зеленый мигающий	зеленый мигающий
KZ	жасыл	сарғылт	жасыл жыпықтайтын	жасыл жыпықтайтын

ASCO	FUNCTIONING DIAGRAM	EN	DIAGRAMME DE FONCTIONNEMENT	FR	FUNKTIONSSCHEMA	DE	DC
	DIAGRAMA DE FUNCIONAMIENTO	ES	DIAGRAMMA DI FUNZIONAMENTO	IT	WERKING SCHEMA	NL	
	DIAGRAMA DE FUNCIONAMENTO	PT	СХЕМА РАБОТЫ	RU	закончите работу диаграммы	KZ	

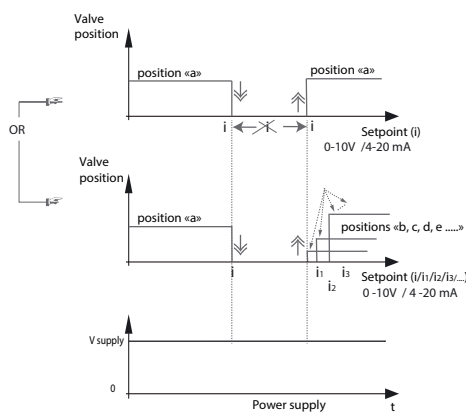

lost setpoint	EN
perte de consigne	FR
Sollwertausfall	DE
pérdida de consigna	ES
Interruzione setpoint	IT
verloren setpoint	NL
setpoint perdido	PT
потерял уставки	RU
жоғалған орнатылған мән	KZ

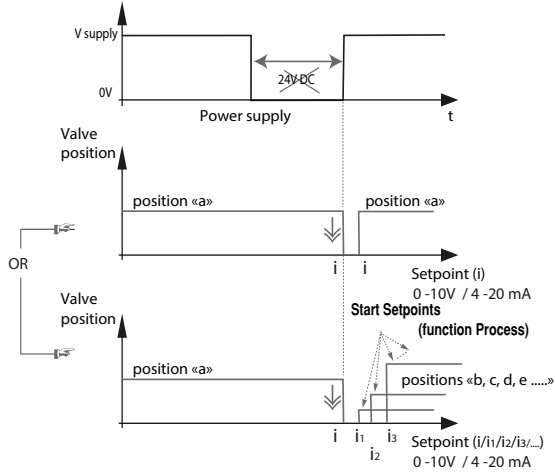

lost supply	EN
perte alimentation	FR
Ausfall der Spannungsversorgung	DE
pérdida de alimentación	ES
Interruzione alimentazione	IT
verloren levering	NL
alimentação perdida	PT
потерял питания	RU
жоғалған қуат көзі	KZ