

<b>numatics</b>	INSTALLATION AND MAINTENANCE INSTRUCTIONS	EN
	INSTRUCTIONS D'INSTALLATION ET DE MAINTENANCE	FR
	INBETRIEBNAHME - UND WARTUNGSANLEITUNG	DE
	INSTRUCCIONES DE PUESTA EN MARCHA Y MANTENIMIENTO	ES
	ISTRUZIONI DI MESSA IN SERVIZIO E MANUTENZIONE	IT
	ALGEMENE INSTALLATIE- EN ONDERHOUDSINSTRUCTIES	NL
	INSTALLASJONS- OG VEDLIKEHOLDSINSTRUKSER	NO
	INSTALLATIONS- OCH UNDERHÅLLSINSTRUKTIONER	SE
	ASENNUS - JA HUOLTO-OHJEET	FI
	INSTALLATIONS - OG VEDLIGEHOIDSANVISNINGER	DK
	INSTRUÇÕES DE INSTALAÇÃO E MANUTENÇÃO	PT
	ΟΔΗΓΙΕΣ ΤΟΠΟΘΕΤΗΣΗΣ ΚΑΙ ΣΥΝΤΗΡΗΣΗΣ	GR
	POKRYTY PRO INSTALACI A ÚDRŽBU	CZ
	INSTRUKCJA MONTAŻU I KONSERWACJI	PL
TELEPÍTÉSI ÉS KARBANTARTÁSI ÚTMUTATÓ	HU	
Инструкция по установке и обслуживанию	RU	
ΟΡΗΑΤΥ ЖӘНЕ ҚЫЗМЕТ КӨРСЕТУ НҰСҚАУЛАР	KZ	

**502**

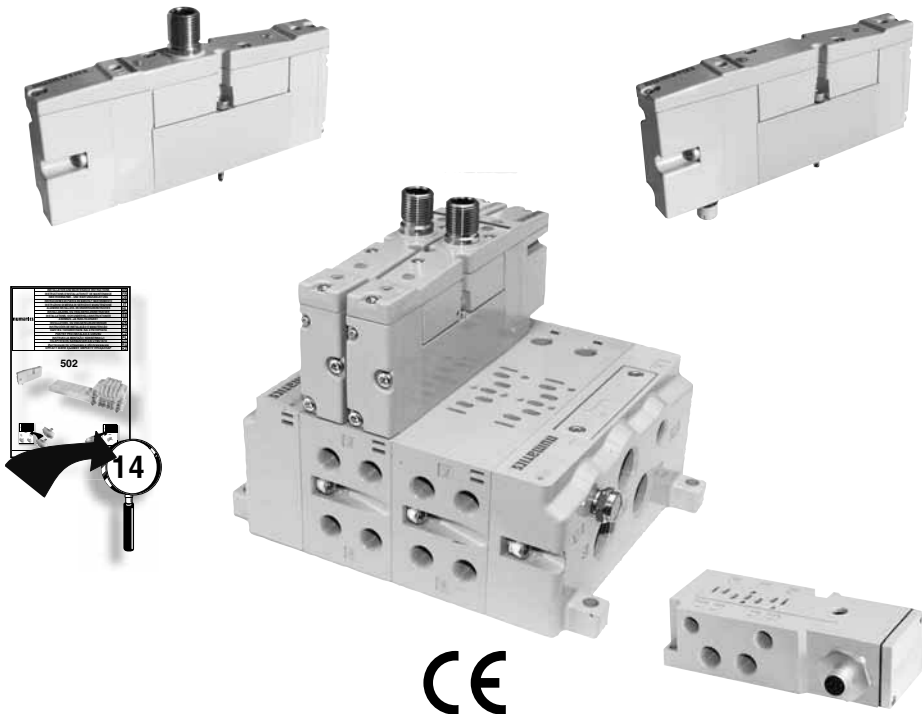

**CE**

527166-001 / C  
Availability, design and specifications are subject to change without notice. All rights reserved.

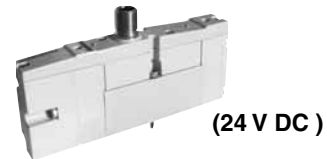
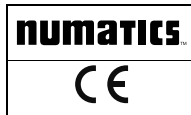

ISO 15407-1 18 mm

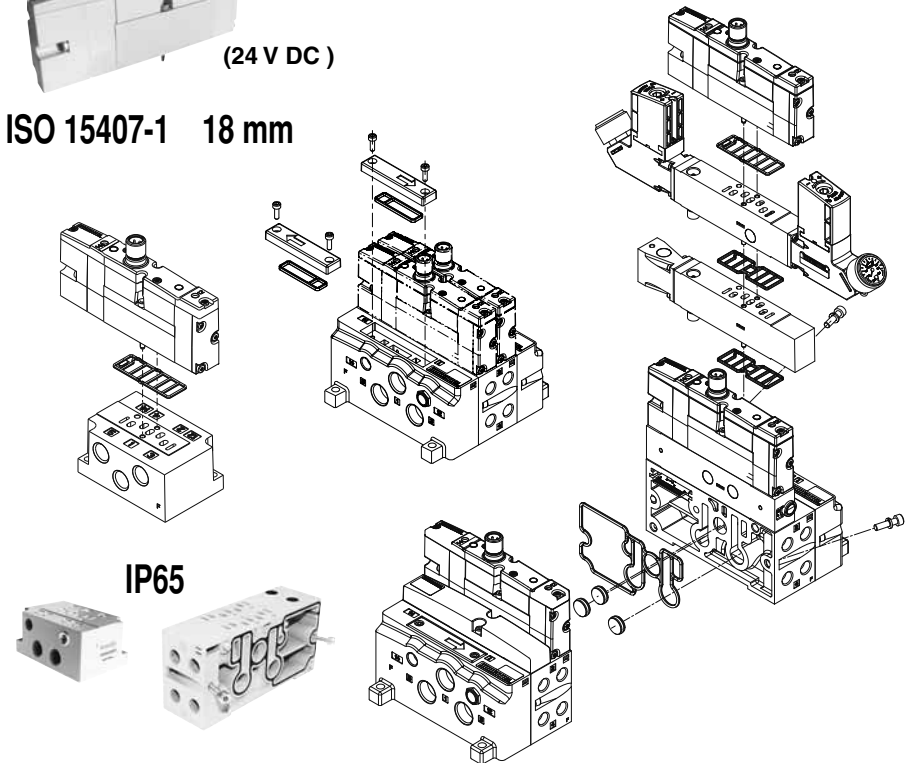

IP65

(24 V DC )



ISO 15407-2 18 mm







IP65

(24 V DC )

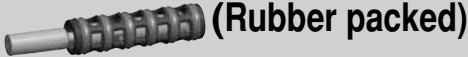



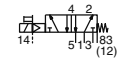
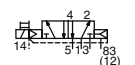
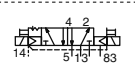

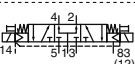
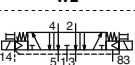

numatics		rated flow			14 P <sub>p</sub> (bar) (23°C)		1 P (bar)		
		 l/min	 l/min (ANR)		min.	max.	min.	max. (PS)	
(14)	(12)	1→2 1→4	2→3 4→5	(ms)			min.	max. (PS)	
<b>(Rubber packed)</b>									
<b>internal pilot supply</b>									
<b>2 x 3/2 NC</b>	K		500	440	36 / 15	-	-	4	10
<b>external pilot supply</b>									
<b>2 x 3/2 NC</b>	K		500	440	36 / 15	4	10	2	10

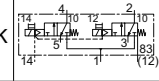

numatics		rated flow			14 P <sub>p</sub> (bar) (23°C)		1 P (bar)			
		 l/min	 l/min (ANR)		min.	max.	min.	max. (PS)		
(14)	(12)	1→2 1→4	2→3 4→5	(ms)			min.	max. (PS)		
<b>(Spool &amp; Sleeve)</b>										
<b>internal pilot supply</b>										
<b>5/2</b>			410	390	16 / 49	-	-	2	10	
			410	390	11 / 26	-	-	1,5	10	
			410	390	16 / 16	-	-	2	8	
<b>5/3</b>			360	350	12 / 12	-	-	1,5	10	
			370	350	13 / 23	-	-	1,5	8	
			340	350	23 / 13	-	-	1,5	8	
<b>external pilot supply</b>										
<b>5/2</b>			410	390	16 / 49	2	10	-	-0,95	10
			410	390	11 / 26	1,5	10	-	-0,95	10
			410	390	16 / 16	2	10	-	-0,95	10
<b>5/3</b>			360	350	12 / 12	1,5	10	-	-0,95	10
			370	350	13 / 23	1,5	10	-	-0,95	10
			340	350	23 / 13	1,5	10	-	-0,95	10

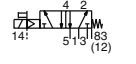
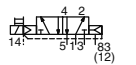
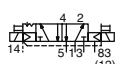
<b>numatics</b>		15-DIGIT PRODUCT CODE 		
		with impulse manual operator ISO 15407-1 18 mm	with maintained manual operator ISO 15407-1 18 mm	without manual operator ISO 15407-1 18 mm
(14) (12)				
 (Rubber packed)				
2 x 3/2 NC		R502A2BD0N83BF1 (R502A2BD0N82PF1) (b)	R502A2BD0N82MF1 (R502A2BD0N69PF1) (b)	R502A2BD0N82NF1 (R502A2BD0N69NF1) (b)
 (Spool & Sleeve)				
		R502A1B10N83BF1 (R502A1B10N82PF1) (b)	R502A1B10N82MF1 (R502A1B10N69PF1) (b)	R502A1B10N82NF1 (R502A1B10N69NF1) (b)
		R502A1BN0N83BF1 (R502A1BN0N82PF1) (b)	R502A1BN0N82MF1 (R502A1BN0N69PF1) (b)	R502A1BN0N82NF1 (R502A1BN0N69NF1) (b)
		R502A1B40N83BF1 (R502A1B40N82PF1) (b)	R502A1B40N82MF1 (R502A1B40N69PF1) (b)	R502A1B40N82NF1 (R502A1B40N69NF1) (b)
		R502A1B60N83BF1 (R502A1B60N82PF1) (b)	R502A1B60N82MF1 (R502A1B60N69PF1) (b)	R502A1B60N82NF1 (R502A1B60N69NF1) (b)
		R502A1B70N83BF1 (R502A1B70N82PF1) (b)	R502A1B70N82MF1 (R502A1B70N69PF1) (b)	R502A1B70N82NF1 (R502A1B70N69NF1) (b)
		R502A1B50N83BF1 (R502A1B50N82PF1) (b)	R502A1B50N82MF1 (R502A1B50N69PF1) (b)	R502A1B50N82NF1 (R502A1B50N69NF1) (b)

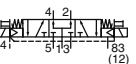
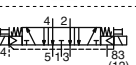
(b) Internal piloting (internal supply).

<b>numatics</b>		15-DIGIT PRODUCT CODE 		
		with impulse manual operator ISO 15407-2 18 mm	with maintained manual operator ISO 15407-2 18 mm	without manual operator ISO 15407-2 18 mm
(14) (12)				
 (Rubber packed)				
2 x 3/2 NC		R502A2BD0MA00F1	R502A2BD0M11BF1	R502A2BD0M11MF1
 (Spool & Sleeve)				
		R502A1B10MA00F1	R502A1B10M11BF1	R502A1B10M11MF1
		R502A1BN0NA00F1	R502A1BN0M11BF1	R502A1BN0M11MF1
		R502A1B40MA00F1	R502A1B40M11BF1	R502A1B40M11MF1
		R502A1B60MA00F1	R502A1B60M11BF1	R502A1B60M11MF1
		R502A1B70MA00F1	R502A1B70M11BF1	R502A1B70M11MF1
		R502A1B50MA00F1	R502A1B50M11BF1	R502A1B50M11MF1

**AIR QUALITY [ ISO 8573-1 (2010) ]: Level 7.4.4**

40 μm ↔ 5 μm

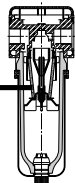

**AIR QUALITY [ ISO 8573-1 (2010) ]: Level 7.4.4**

40 μm ↔ 5 μm

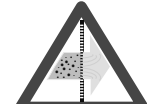

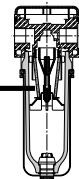
**numatics**

502



<p><b>G502AA3A20A0030</b></p>		<p>1-2-3-4-5 = 5 x G 3/8 12 = G 1/8</p>	
<p><b>US ▶ 8502AA3A20A0030</b></p>		<p>1-2-3-4-5 = 5 x NPT 3/8 12 = NPT 1/8</p>	
<p><b>G502AA3A2014X30</b></p>		<p>1-2-3-4-5 = 5 x G 3/8 12 = G 1/8 14 = G 1/8</p>	
<p><b>US ▶ 8502AA3A2014X30</b></p>		<p>1-2-3-4-5 = 5 x NPT 3/8 12 = NPT 1/8 14 = NPT 1/8</p>	

<p><b>G502AA3A2M56Y20</b></p>		<p>1-2-3-4-5 = 5 x G 3/8 12 = G 1/8</p>	
<p><b>US ▶ 8502AA3A2M56Y20</b></p>		<p>1-2-3-4-5 = 5 x NPT 3/8 12 = NPT 1/8</p>	
<p><b>G502AA3A2M59W20</b></p>		<p>1-2-3-4-5 = 5 x G 3/8 12 = G 1/8 14 = G 1/8</p>	
<p><b>US ▶ 8502AA3A2M59W20</b></p>		<p>1-2-3-4-5 = 5 x NPT 3/8 12 = NPT 1/8 14 = NPT 1/8</p>	

**numatics**

502

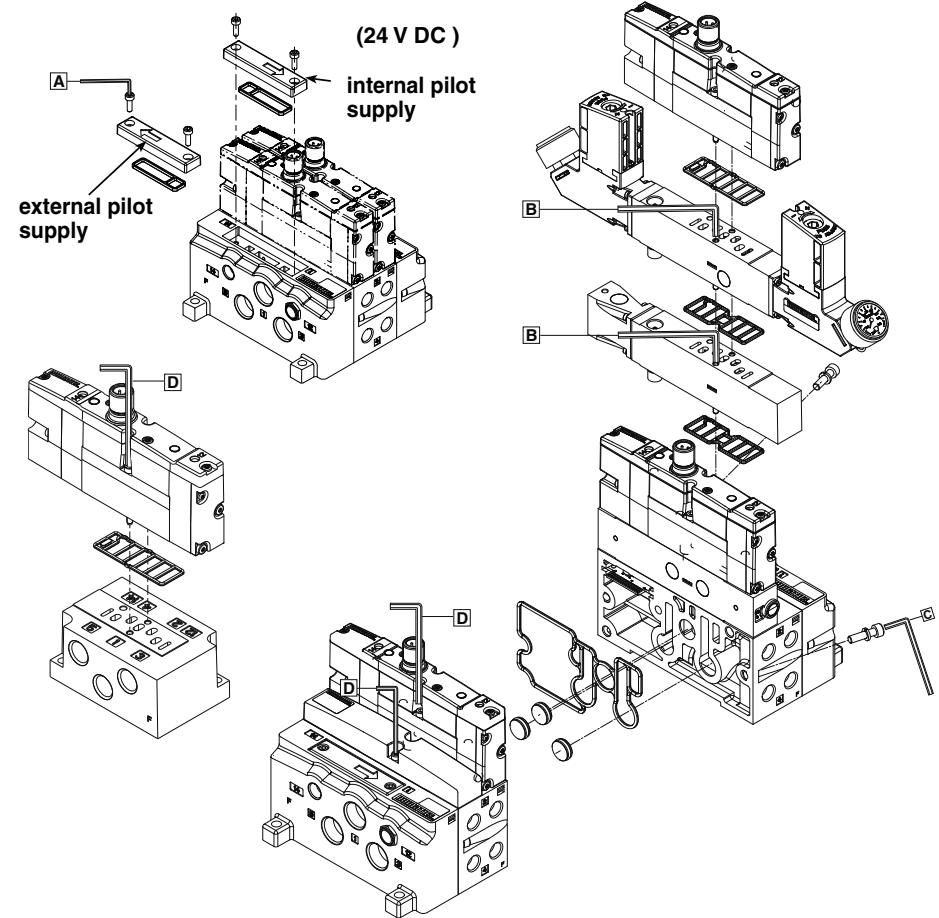
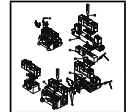

items	N.m	Inch.pounds
<b>A</b>	2 ±10%	17.7 ±1.8
<b>B</b>	1.2 ±10%	10.6 ±1.1
<b>C</b>	4.6 ±10%	40.7 ±4.1
<b>D</b>	2 ±10%	17.7 ±1.8





	<b>G502AMV210A0030</b>	4 x G 1/8		
<b>US</b>	<b>8502AMV210A0030</b>	4 x NPT 1/8		

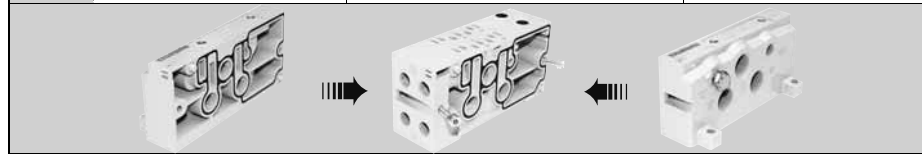

	<b>G502AK431478004</b>	3 x G 3/8 (1/3/5) 2 x G 1/8 (12/14)	
<b>US</b>	<b>8502AK431478001</b>	3 x NPT 3/8 (1/3/5) 2 x NPT 1/8 (12/14)	

<b>P502AB431813001</b>		
------------------------	--	--

<b>P502AD431914001</b>		+		•	1
<b>P502AD431914002</b>		+		•	3
<b>P502AD431914003</b>		+		•	5
<b>P502AD431914004</b>		+		•	1, 3
<b>P502AD431914005</b>		+		•	1, 5
<b>P502AD431914006</b>		+		•	3, 5
<b>P502AD431914007</b>		+		•	1, 3, 5

**ISO 15407-1**



	<b>R502AY506752001</b>	
--	------------------------	--

<b>G1/4</b> 	<b>G502AW506753002</b>	
-----------------	------------------------	--

<b>G1/4</b> 	<b>G502AX506753001</b>	
-----------------	------------------------	--

	<b>R502AS506755001</b>	
--	------------------------	--

**numatics**

502

0,7 .. 9 bar



0,7 .. 9 bar  
ISO 15407-1



R502ARS120A0030	RS			
R502ARS12061Y30				
R502ARD12016P30	RD			
R502ARD12063L30				
R502ARD12016N30				
R502ARD12063M30				
R502ARD120A0030				
R502ARD12061Y30				
R502ARE12016P00	RE			
R502ARE12063L00				
R502ARE12016N00				
R502ARE12063M00				
R502ARE120A0000				
R502ARE12061Y00				
R502ART12016P30	RT			
R502ART12063L30				
R502ART12016N30				
R502ART12063M30				
R502ART120A0030				
R502ART12061Y30				

**numatics**

502

10 .. 130 psig



PSIG ► 10 .. 130 psig  
ISO 15407-1



R502ARS110A0030	RS			
R502ARS11061Y30				
R502ARD11016P30	RD			
R502ARD11063L30				
R502ARD11016N30				
R502ARD11063M30				
R502ARD110A0030				
R502ARD11061Y30				
R502ARE11016N30	RE			
R502ARE11063L00				
R502ARE11016N00				
R502ARE11063M00				
R502ARE110A0000				
R502ARE11061Y00				
R502ART110A0030	RT			
R502ART11063L30				
R502ART11016N30				
R502ART11063M30				
R502ART110A0030				
R502ART11061Y30				

<b>numatics</b>	INSTALLATION AND MAINTENANCE INSTRUCTIONS	EN
	INSTRUCTIONS D'INSTALLATION ET DE MAINTENANCE	FR
	INBETRIEBNAHME - UND WARTUNGSANLEITUNG	DE
	INSTRUCCIONES DE PUESTA EN MARCHA Y MANTENIMIENTO	ES
	ISTRUZIONI DI MESSA IN SERVIZIO E MANUTENZIONE	IT
	ALGEMENE INSTALLATIE- EN ONDERHOUDSINSTRUCTIES	NL
	INSTALLASJONS- OG VEDLIKEHOLDSINSTRUKSER	NO
	INSTALLATIONS- OCH UNDERHÅLLSINSTRUKTIONER	SE
	ASENNUS - JA HUOLTO-OHJEET	FI
	INSTALLATIONS - OG VEDLIGEHOLDSANVISNINGER	DK
	INSTRUÇÕES DE INSTALAÇÃO E MANUTENÇÃO	PT
	ΟΔΗΓΙΕΣ ΤΟΠΟΘΕΤΗΣΗΣ ΚΑΙ ΣΥΝΤΗΡΗΣΗΣ	GR
POKRYTY PRO INSTALACI A ÚDRŽBU	CZ	
INSTRUKCJA MONTAŻU I KONSERWACJI	PL	
TELEPÍTÉSI ÉS KARBANTARTÁSI ÚTMUTATÓ	HU	
Инструкция по установке и обслуживанию	RU	
ОРНАТУ ЖӘНЕ ҚЫЗМЕТ КӨРСЕТУ НҰСҚАУЛАР	KZ	

**502**

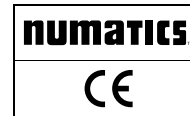
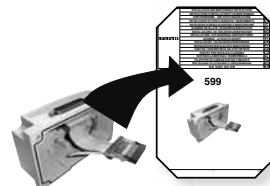
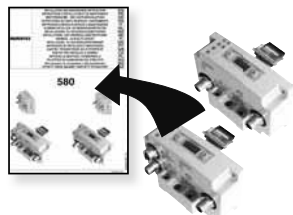
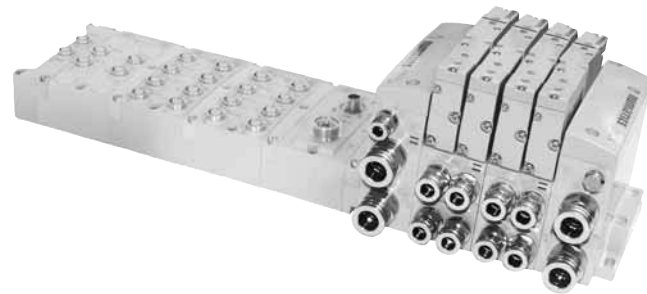
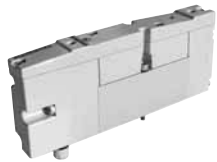

(24 V DC)



High flow

ISO 15407-2 / 18mm

SGL

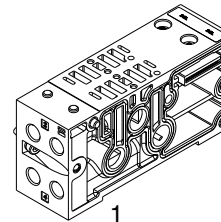

8 G 502AM**S2**GMA0010  
K F H

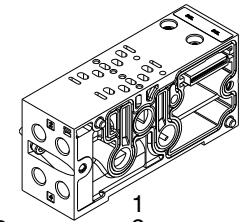
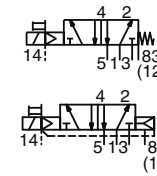

8 G 502AM**S2**GMA0020  
K F H

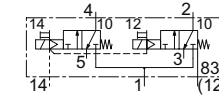

(Rubber packed)

DBL

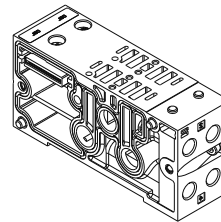

8 G 502AM**M2**GMA0010  
K F H

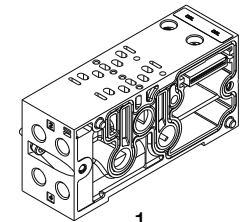
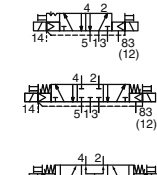

8 G 502AM**M2**GMA0020  
K F H

Accessory  
Z-board™  
Mid station  
supply

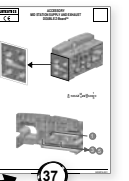

37



X-16 Driver  
→ 80 Solenoids  
(24 V DC)

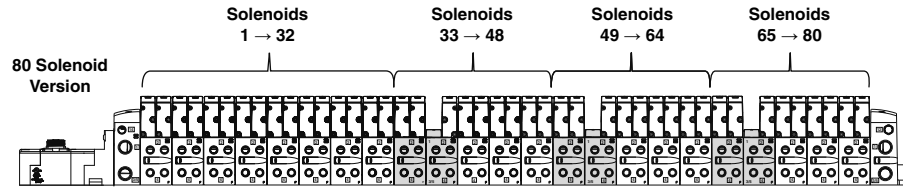

8 G 502AFM4 K  
1 TA0010  
2 TA0020  
F  
H  
G

WIRING DIAGRAM

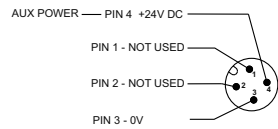

Auxiliary Power and X-16 Driver

Mid-Station Supply

Auxiliary Power and X-16 Driver

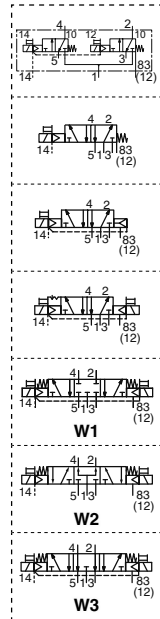

High flow

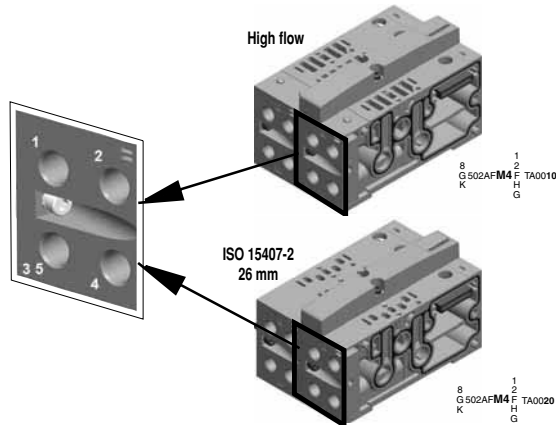

DBL



rated flow

6,3 bar  
l/min (ANR)

1→2 2→3  
1→4 4→5

o / c  
(ms)

14 P<sub>p</sub> (bar) (23°C)

max.  
min.

1 P (bar)

max. (PS)  
=

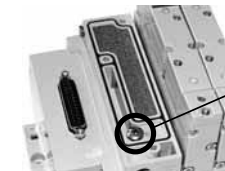

internal pilot supply

2 x 3/2 NC

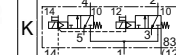

High flow

-

650 600

36 / 15

-

-

4

8

-

ISO

500 440

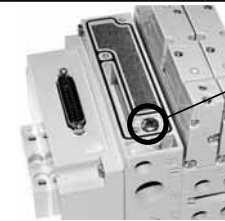

external pilot supply

2 x 3/2 NC

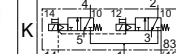

High flow

-

650 600

36 / 15

4

8

2

8

-

ISO

500 440

<b>numatics</b>			rated flow  l/min 6,3 bar l/min (ANR)	 o / c (ms)	 14 P <sub>p</sub> (bar) min.	(23°C) max.	 1 P (bar) min.	max. (PS) =	
(14) (12)			1→2 1→4						
<b>(Spool &amp; Sleeve)</b>									
→ internal pilot supply									
<b>5/2</b> 		High flow	470	530	16 / 49	-	-	2	8
		High flow	470	530	11 / 26	-	-	1,5	8
		High flow	470	530	16 / 16	-	-	2	8
<b>5/3</b> 		High flow	420	440	12 / 12	-	-	1,5	8
		High flow	420	430	13 / 23	-	-	1,5	8
		High flow	380	500	23 / 13	-	-	1,5	8
← external pilot supply									
<b>5/2</b> 		High flow	470	530	16 / 49	2	8	-0,95	8
		High flow	470	530	11 / 26	1,5	8	-0,95	8
		High flow	470	530	16 / 16	2	8	-0,95	8
<b>5/3</b> 		High flow	420	440	12 / 12	1,5	8	-0,95	8
		High flow	420	430	13 / 23	1,5	8	-0,95	8
		High flow	380	500	23 / 13	1,5	8	-0,95	8

<b>numatics</b>			15-DIGIT PRODUCT CODE		
(14) (12)		with impulse manual operator	with maintained manual operator	without manual operator	
<b>(Rubber packed)</b>					
<b>2 x 3/2 NC</b>	K		R502A2BD0MA00F1	R502A2BD0M11BF1	R502A2BD0M11MF1
<b>(Spool &amp; Sleeve)</b>					
<b>5/2</b> 			R502A1B10MA00F1	R502A1B10M11BF1	R502A1B10M11MF1
			R502A1BN0NA00F1	R502A1BN0M11BF1	R502A1BN0M11MF1
			R502A1B40MA00F1	R502A1B40M11BF1	R502A1B40M11MF1
<b>5/3</b> 			R502A1B60MA00F1	R502A1B60M11BF1	R502A1B60M11MF1
			R502A1B70MA00F1	R502A1B70M11BF1	R502A1B70M11MF1
			R502A1B50MA00F1	R502A1B50M11BF1	R502A1B50M11MF1

AIR QUALITY [ ISO 8573-1 (2010) ]: Level 7.4.4



40 μm ↔ 5 μm

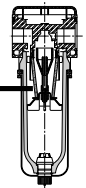

**numatics**

502

25 Pin Sub-D:  
SGL = 22 max. / DBL = 11 max.  
37 Pin Sub-D:  
SGL = 32 max. / DBL = 16 max.

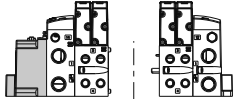

19 Pin Round Connector:  
SGL = 16 max. / DBL = 8 max.

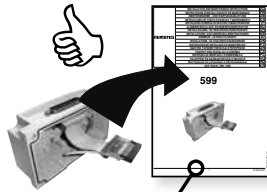
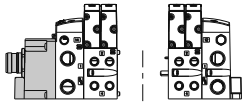

1-32 Terminal Strip:  
SGL = 32 max. / DBL = 16 max.

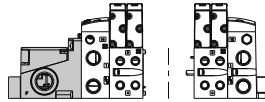

26 Pin Round Connector:  
SGL = 22 max. / DBL = 11 max.

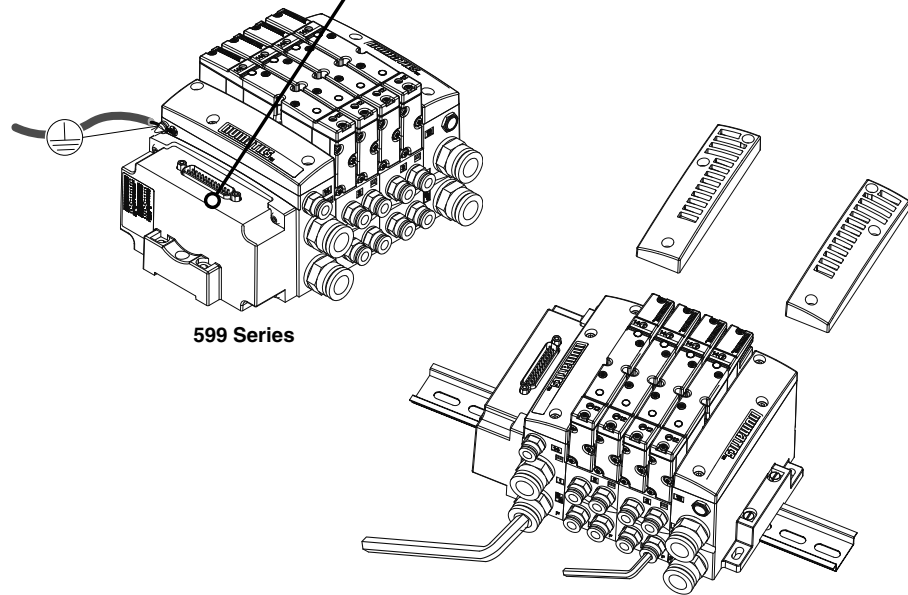
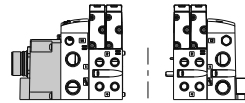

599 Series

**numatics**

502

G3 → 502

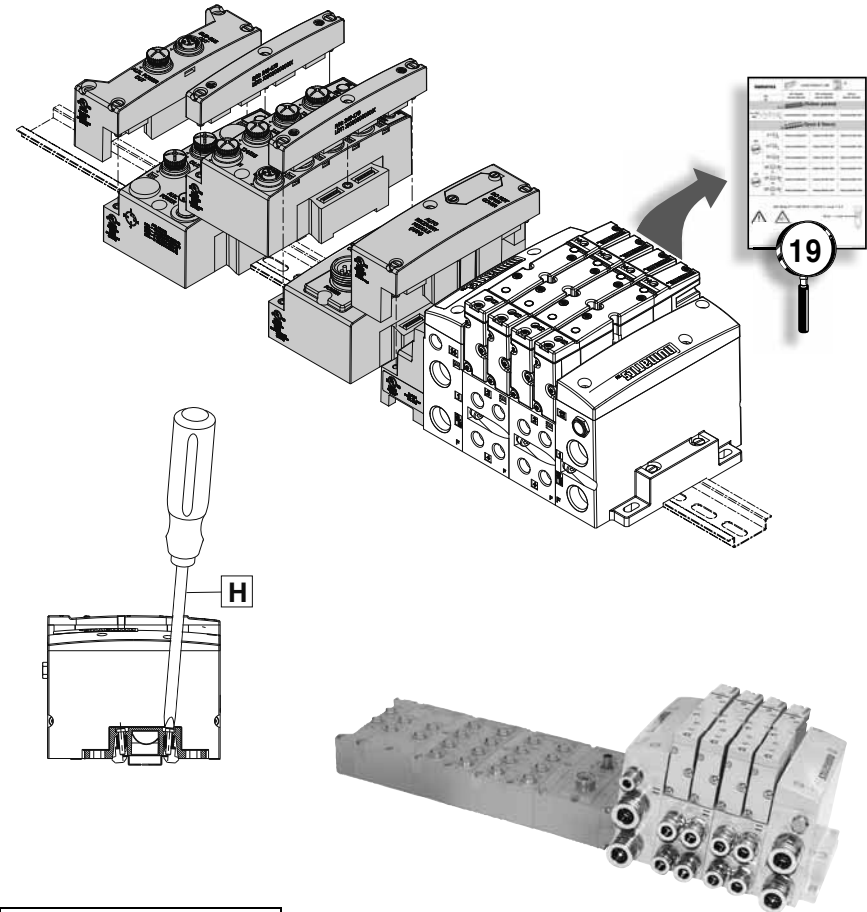

items	N.m	Inch.pounds
H	2.65	23.4

**numatics**

502



items	N.m	Inch.pounds
C	4.6 ± 10%	40.7 ± 4.1
D	2.0 ± 10%	17.7 ± 1.8
J	2.4 ± 10%	21.0 ± 2.1

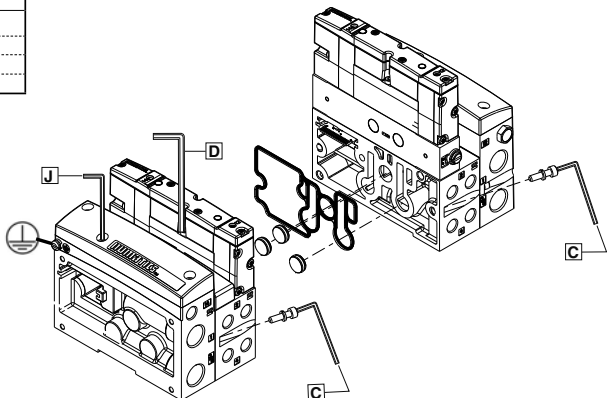

<b>P502AB431813001</b>		
------------------------	--	--

<b>P502AD431914001</b>		+		•	1
<b>P502AD431914002</b>		+		•	3
<b>P502AD431914003</b>		+		•	5
<b>P502AD431914004</b>		+		•	1, 3
<b>P502AD431914005</b>		+		•	1, 5
<b>P502AD431914006</b>		+		•	3, 5
<b>P502AD431914007</b>		+		•	1, 3, 5

**numatics**

502



G (ISO 228/1)	1/8	6 mm	6 mm	Kit
			<b>G502AK431477013</b>	
			<b>K502AK431477015</b>	
			<b>K502AK431477017</b>	
			<b>G502AK431477014</b>	
			<b>K502AK431477016</b>	
			<b>K502AK431477018</b>	



			<b>G502AK431477019</b>	
			<b>K502AK431477021</b>	
			<b>K502AK431477023</b>	
			<b>G502AK431477020</b>	
			<b>K502AK431477022</b>	
			<b>K502AK431477024</b>	

**numatics**  
502



NPT	1/8 3/8	1/4 PF 3/8 PF	1/4 PF 1/2 PF	Kit	
thumbs up		thumbs up	thumbs up		8502AK431477001 K502AK431477005 K502AK431477003
thumbs up		thumbs up	thumbs up		8502AK431477002 K502AK431477006 K502AK431477004
thumbs up		thumbs up	thumbs up		8502AK431477007 K502AK431477011 K502AK431477009
thumbs up		thumbs up	thumbs up		8502AK431477008 K502AK431477012 K502AK431477010

**numatics**  
502

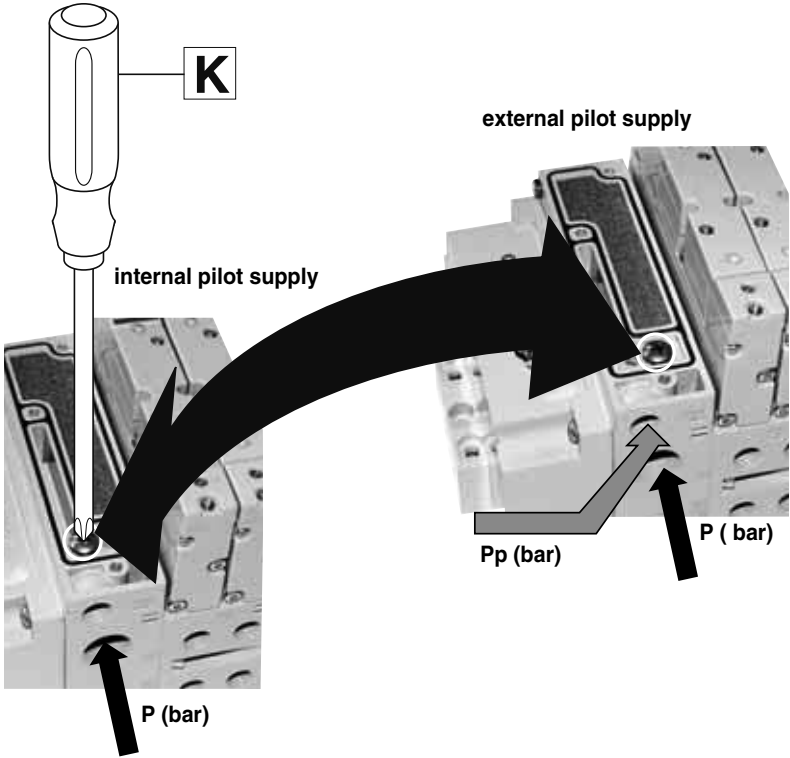

items	N.m	Inch.pounds
K	2,6 ±10%	23 ± 2.3



**numatics**

502

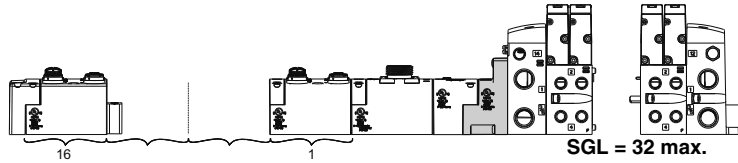

SGL = 32 max.  
DBL = 16 max.

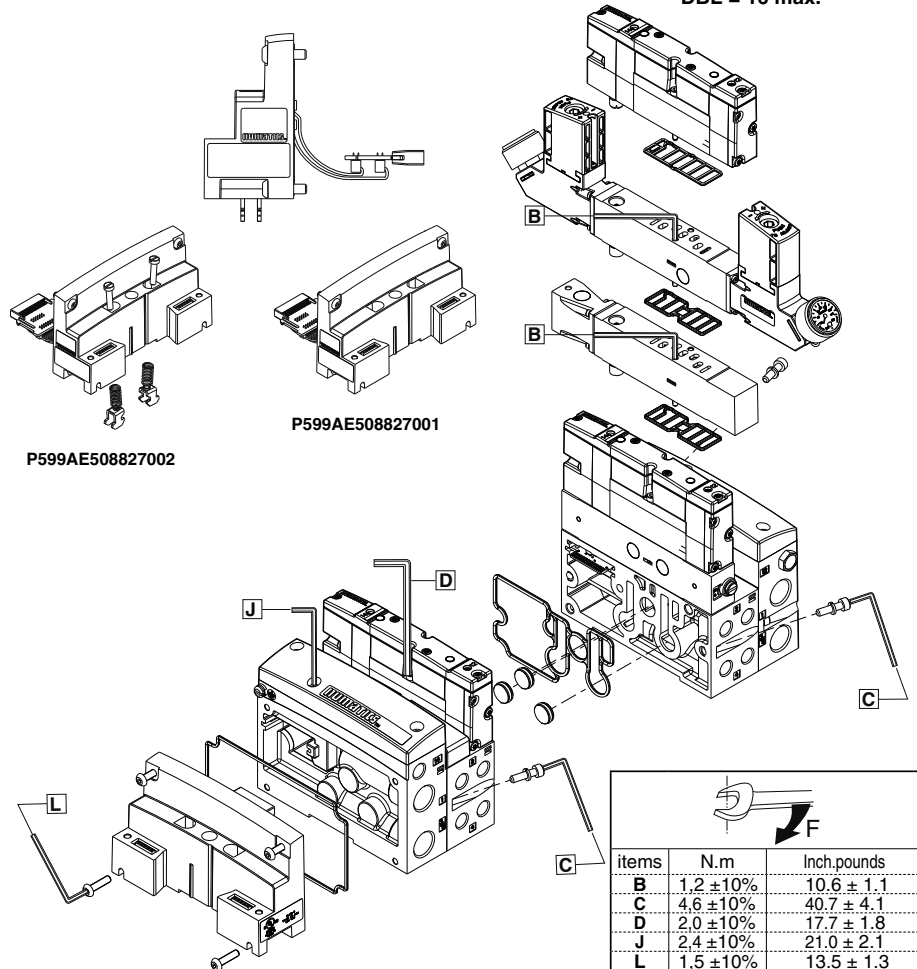

P599AE508827002

P599AE508827001

items	N.m	Inch.pounds
B	1,2 ±10%	10,6 ± 1.1
C	4,6 ±10%	40,7 ± 4.1
D	2,0 ±10%	17,7 ± 1.8
J	2,4 ±10%	21,0 ± 2.1
L	1,5 ±10%	13,5 ± 1.3

**numatics**

502

G3 / 580 / 599

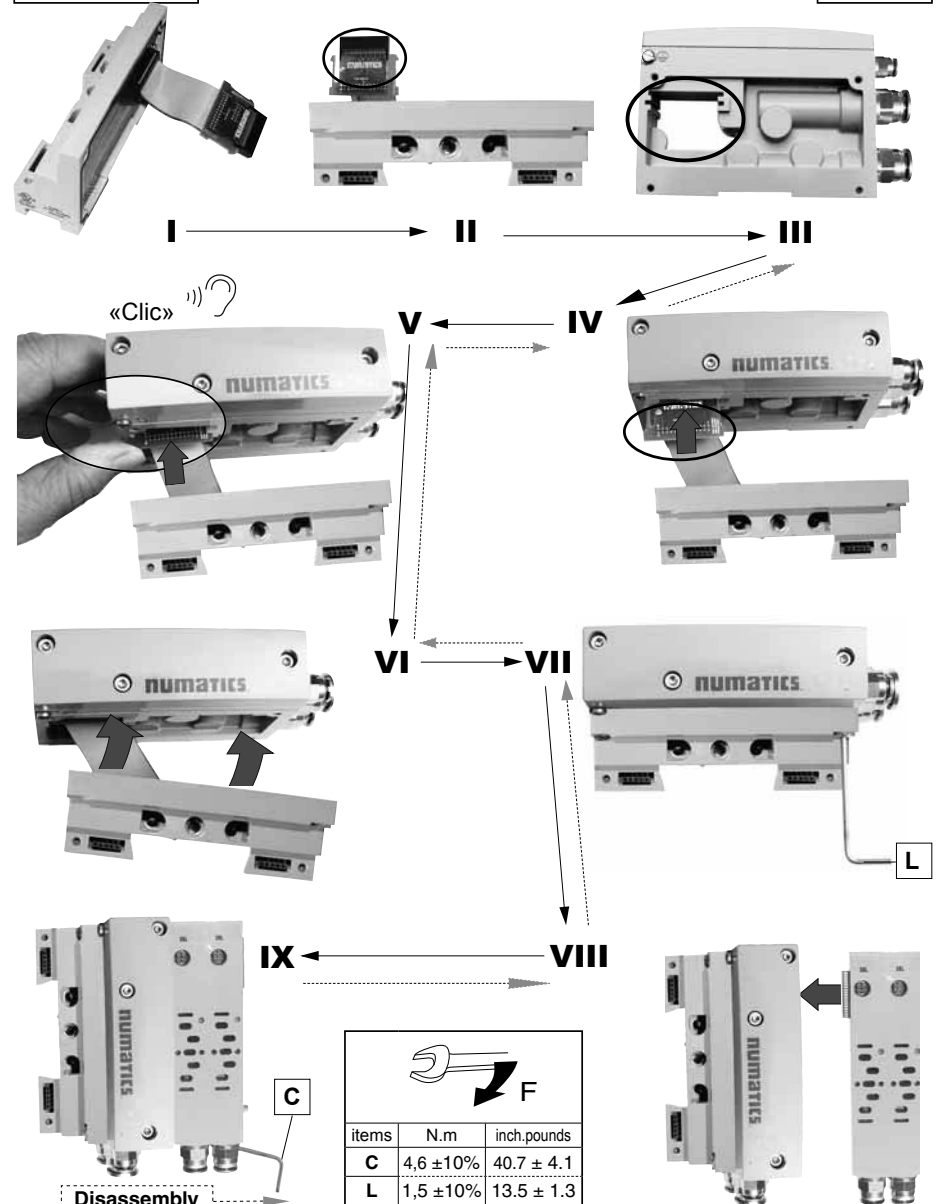

Disassembly

items	N.m	inch.pounds
C	4,6 ±10%	40,7 ± 4.1
L	1,5 ±10%	13,5 ± 1.3

**numatics**

502

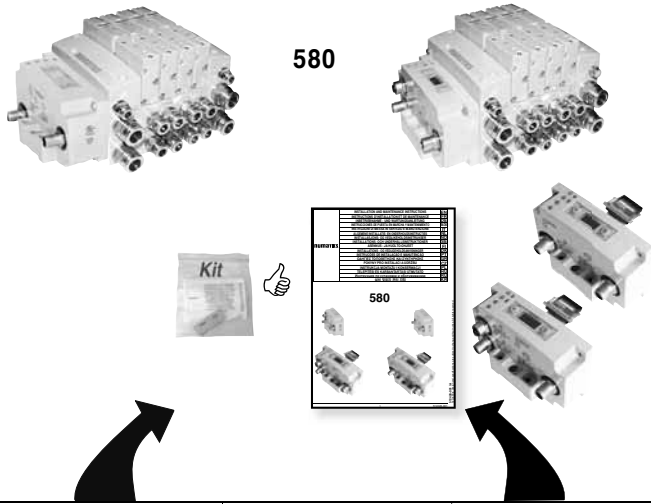

	CANopen®		POWERLINK
	DeviceNet™		Ethernet/IP™
	PROFIBUS-DP®		EtherCAT®
	EtherNET/IP™ DLR		PROFINET®
	SUB-BUS		CHARM
	IO-Link Class A (4 pin)		IO-Link Class B (5 pin)

**numatics**

502



		<b>R502AY429409002</b>	
	<b>G1/4 NPT 1/4</b> 	<b>G502AW428685004</b> <b>US ▶ 8502AW428685004</b>	
	<b>G1/4 NPT 1/4</b> 	<b>G502AX428685002</b> <b>US ▶ 8502AX428685002</b>	
		<b>R502AS429395002</b>	
		<b>R502AY429409001</b>	
	<b>G1/4 NPT 1/4</b> 	<b>G502AW428685003</b> <b>US ▶ 8502AW428685003</b>	
	<b>G1/4 NPT 1/4</b> 	<b>G502AX428685001</b> <b>US ▶ 8502AX428685001</b>	
		<b>R502AS429395001</b>	
		<b>G502AP428685005</b> <b>US ▶ 8502AP428685005</b>	
		<b>G502AP428685006</b> <b>US ▶ 8502AP428685006</b>	

**numatics**

502



High flow  
0,7 ... 9 bar



**numatics**

502



High flow  
10 ... 130 psig

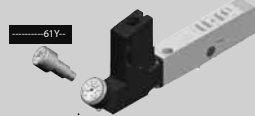

R502ARS12JA0010	RS			
R502ARS12J61Y10		....RS...A00.		
R502ARD12J16P10	RD			
R502ARD12J63L10		....RD...16P..		
R502ARD12J16N10				
R502ARD12J63M10		....RD...16N..		
R502ARD12JA0010		....RD...A00..		
R502ARD12J61Y10				
R502ARE12J16P10	RE			
R502ARE12J63L10		....RE...16P..		
R502ARE12J16N10				
R502ARE12J63M10		....RE...16N..		
R502ARE12JA0010		....RE...A00..		
R502ARE12J61Y10				
R502ART12J16P10	RT			
R502ART12J63L10		....RT...16P..		
R502ART12J16N10				
R502ART12J63M10		....RT...16N..		
R502ART12JA0010		....RT...A00..		
R502ART12J61Y10				

R502ARS11JA0010	RS			
R502ARS11J61Y10		....RS...A00.		
R502ARD11J16P10	RD			
R502ARD11J63L10		....RD...16P..		
R502ARD11J16N10				
R502ARD11J63M10		....RD...16N..		
R502ARD11JA0010		....RD...A00..		
R502ARD11J61Y10				
R502ARE11J16P10	RE			
R502ARE11J63L10		....RE...16P..		
R502ARE11J16N10				
R502ARE11J63M10		....RE...16N..		
R502ARE11JA0010		....RE...A00..		
R502ARE11J61Y10				
R502ART11J16P10	RT			
R502ART11J63L10		....RT...16P..		
R502ART11J16N10				
R502ART11J63M10		....RT...16N..		
R502ART11JA0010		....RT...A00..		
R502ART11J61Y10				

**numatics**  
502



ISO 15407-2  
18 mm  
0,7 ... 9 bar

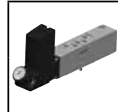

**numatics**  
502



ISO 15407-2  
18 mm  
10 ... 130 psig



<p>R502ARS12JA0020</p> <p>R502ARS12J61Y20</p>	<p>RS</p> <p>....RS...A00.</p>
<p>R502ARD12J16P20</p> <p>R502ARD12J63L20</p> <p>R502ARD12J16N20</p> <p>R502ARD12J63M20</p> <p>R502ARD12JA0020</p> <p>R502ARD12J61Y20</p>	<p>RD</p> <p>....RD...16P..      ....RD...16N..      ....RD...A00..</p>
<p>R502ARE12J16P20</p> <p>R502ARE12J63L20</p> <p>R502ARE12J16N20</p> <p>R502ARE12J63M20</p> <p>R502ARE12JA0020</p> <p>R502ARE12J61Y20</p>	<p>RE</p> <p>....RE...16P..      ....RE...16N..      ....RE...A00..</p>
<p>R502ART12J16P20</p> <p>R502ART12J63L20</p> <p>R502ART12J16N20</p> <p>R502ART12J63M20</p> <p>R502ART12JA0020</p> <p>R502ART12J61Y20</p>	<p>RT</p> <p>....RT...16P..      ....RT...16N..      ....RT...A00..</p>

<p>R502ARS11JA0020</p> <p>R502ARS11J61Y20</p>	<p>RS</p> <p>....RS...A00.</p>
<p>R502ARD11J16P20</p> <p>R502ARD11J63L20</p> <p>R502ARD11J16N20</p> <p>R502ARD11J63M20</p> <p>R502ARD11JA0020</p> <p>R502ARD11J61Y20</p>	<p>RD</p> <p>....RD...16P..      ....RD...16N..      ....RD...A00..</p>
<p>R502ARE11J16P20</p> <p>R502ARE11J63L20</p> <p>R502ARE11J16N20</p> <p>R502ARE11J63M20</p> <p>R502ARE11JA0020</p> <p>R502ARE11J61Y20</p>	<p>RE</p> <p>....RE...16P..      ....RE...16N..      ....RE...A00..</p>
<p>R502ART11J16P20</p> <p>R502ART11J63L20</p> <p>R502ART11J16N20</p> <p>R502ART11J63M20</p> <p>R502ART11JA0020</p> <p>R502ART11J61Y20</p>	<p>RT</p> <p>....RT...16P..      ....RT...16N..      ....RT...A00..</p>

numatics

502

ACCESSORY ZONED POWER (24 VDC Separation)



WIRING DIAGRAM

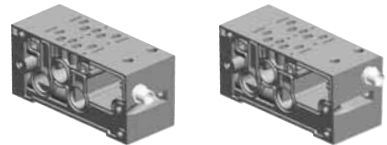
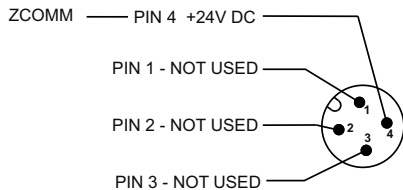

8 G 502AM S M 2 3 V HW A00 1 2 0 K

Table with 2 columns: Language (EN, FR, DE, ES, IT, NL, NO, SE, FI, DK, PT, GR, CZ, PL, HU, RU, KZ) and Description of the accessory in that language.

numatics

502

ACCESSORY ZONED POWER (24 VDC Separation)

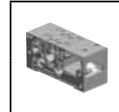

8 G 502AM S M 2 3 V HW A00 1 2 0 K



ISO 13849

Table with 2 columns: Language (EN, FR, DE, ES, IT, NL, NO, SE) and Description of the accessory in that language, including safety and compliance information.

numatics

502



ACCESSORY ZONED POWER (24 VDC Separation)

8 G 502AM S 2 3 V M 2 HW A00 1 2 0 K



ISO 13849



numatics

CE

ACCESSORY MID STATION SUPPLY AND EXHAUST 503 double Z-board, 15407-2 double Z-board and 15407-1 no Zboard

502

- FI** Zoned Power pneumaattista saarekkeita voidaan käyttää osana turvallisuuteen liittyvää ohjausjärjestelmää (SRP/CS) ISO 13849 -standardien mukaisesti kategoriassa 3 / PLd saakka, jos niitä käytetään yhdessä asianmukaisen ulkoisen turvallisuusvalvonnan kanssa (esimerkkejä: seuranta, ajoitus, pulssitesti jne.) ja kaikkien sovellettavien turvallisuusstandardien mukaisesti. ISO 13849 -standardin mukaisesti loppukäyttäjän tai ulkopuolisen organisaation on arvioitava ja sertifioitava koko ohjausjärjestelmä (CS), jyviksi todetut komponentit mukaan lukien. Pyydettyessä voimme toimittaa pneumaattisten saarekkeiden luotettavuus tiedot. Erilaisia käyttökohtauksia kuvataan tarkemmin toimipisteissämme saatavilla olevassa teknisessä käsikirjassamme.
  - ISO 13849-2 -standardin ja tuoteturvallisuusmääräysten mukaan sähkö osiin on syötettävä SELV/PELV-virtalähteistä.
  - Jos tuotetta käytetään ympäristössä, jossa esiintyy sähköä johtavaa pölyä, vettä tai muita aineita, jotka voisivat aiheuttaa sisäisiä oikosulkuja, on käytettävä kaappia tai asianmukaista koteloita.
- DK** Pneumatiske Zoned Power-grupper kan anvendes som del af et SRP/CS-system (Safety Related Product of a Control System) overensstemmende med ISO 13849-sikkerhedsstandarderne op til kategori 3/PLd, hvis de anvendes med en passende ekstern sikkerhedskontrol (f.eks. overvågning, timing, impulstest etc.) og i overensstemmelse med alle relevante sikkerhedsstandarder. I overensstemmelse med ISO 13849 skal slutbrugerne eller tredjepartsorganisationer vurdere og certificere alle CS'er (kontrollsystemer) inklusive de dokumenterede komponenter. Pålidelige data for gruppens komponenter kan oplyses på anmodning. De forskellige typer anvendelse er beskrevet i vores tekniske manual, der er tilgængelig på vores hjemmeside.
  - I overensstemmelse med ISO-standard ISO 13849-2 skal standardiserede og produktikkerhedsrelaterede strømforstyrrelser via SELV/PELV-strømforsyninger.
  - Hvis produktet anvendes i et miljø med ledende støv, vand eller andre medier, der kan forårsage indvendige kortslutninger, skal der anvendes et kabinet eller en egnet indkapsling.
- PT** Pode utilizar as ilhas pneumáticas de Potência Dividida em Zonas como parte de um sistema de controlo relacionado com a segurança (SRP/CS) em conformidade com as normas ISO 13849 até à Categoria 3 / PLd se forem utilizadas com um controlo de segurança externo adequado (exemplos: vigilância, temporização, teste de impulsos, etc.) e em conformidade com todas as normas de segurança associadas. De acordo com a norma ISO 13849, o utilizador final ou terceiro deve avaliar e certificar o Sistema de Controlo completo (CS), incluindo todos os componentes comprovados. Os dados de fiabilidade dos componentes das ilhas podem ser fornecidos a pedido. Diferentes tipos de aplicação são detalhados no nosso manual técnico disponível no nosso site Web.
  - Em conformidade com a norma ISO 13849-2, as peças de segurança dos produtos e padrão têm de ser alimentadas por fontes de alimentação SELV/PELV.
  - Quando utilizar o produto num ambiente com poeira condutora, água ou outros meios que possam originar curtos-circuitos internos, deve utilizar uma caixa ou um armário apropriado.
- GR** Οι pneυματικές μονάδες Zoned Power μπορούν να χρησιμοποιηθούν ως Σύστημα Ελέγχου για θέματα Ασφαλείας (SRP/CS) σε συμμόρφωση με τα πρότυπα του ISO 13849 έως την Κατηγορία 3 / PLd εφόσον χρησιμοποιούνται μαζί με κατάλληλο έλεγχο εξωτερικής ασφαλείας (παραδείγματα: παρακολούθηση, χρονόμετρο, δοκιμή παλμών, κλπ.) και σε συμμόρφωση με όλα τα συναφή πρότυπα ασφαλείας. Σε συμμόρφωση με το ISO 13849, ο τελικός χρήστης ή ο ανεξάρτητος οργανισμός υποχρεούται να προβεί σε αξιολόγηση και πιστοποίηση του συνόλου του Συστήματος Ελέγχου (CS) καθώς επίσης και των αποδεδειγμένων εξαρτημάτων. Τα δεδομένα αξιοπιστίας των εξαρτημάτων των μονάδων διατίθενται, αν ζητηθούν. Στο τεχνικό χειρίδιό που διατίθεται στην ιστοσελίδα μας παρουσιάζονται αναλυτικά διάφοροι τύποι εφαρμογών.
  - Σε συμμόρφωση με το πρότυπο ISO 13849-2 τα κοινά εξαρτήματα και τα εξαρτήματα ασφαλείας προϊόντος πρέπει να συνδέονται με προποστικά SELV/PELV. Όταν το προϊόν χρησιμοποιείται σε περιβάλλοντα που περιέχει αμιωνική σκόνη, νερό ή άλλο μέσο που ενδεχομένως να επιρροήσει εσωτερικά βραχυκυκλώματα, είναι υποχρεωτική η χρήση ερμητικού ή κατάλληλου κελύφους.
- CZ** Pneumatické ostrovy Zoned Power mohou být použity jako součást řídicího systému souvisejícího s bezpečností (SRP/CS) v souladu s normami ISO 13849 až do kategorie 3/PLd, pokud jsou používány s příslušnou vnější kontrolou bezpečnosti (příklady: sledování, měření času, impulsové testy atd.) a v souladu se všemi souvisejícími bezpečnostními normami. V souladu s normou ISO 13849 musí organizace koncového uživatele nebo třetí strany posoudit a certifikovat všechny řídicí systémy (CS) včetně osvědčených součástí. Údaje o spolehlivosti součástí ostrovy poskytneme na vyžádání.
  - V našem technickém manuálu, který je k dispozici na našich stránkách, jsou podrobně popsány různé typy aplikací.
  - V souladu s normou ISO 13849-2 a bezpečnosti výrobků musejí být části napájené napájecími zdroji SELV/PELV.
  - Pokud je výrobek používán v prostředí, které obsahuje vodivý prach, vodu nebo jiné médium, které by mohlo vyvolat vnitřní zkratky, musí být použita skříň nebo příslušný kryt.
- PL** Wyspy pneumatyczne mocy sterowej można stosować jako część systemu sterowania związanego z bezpieczeństwem (SRP/CS) zgodnie z normami ISO 13849 do kategorii 3 / PLd, jeśli zostaną zastosowane z odpowiednim zewnętrznym sterowaniem bezpieczeństwa (na przykład: nadzór, synchronizacja, test impulsu itp.) oraz zgodnie ze wszystkimi powiązanymi normami bezpieczeństwa. Zgodnie z normą ISO 13849 użytkownik końcowy lub strona trzecia muszą poddać ocenie i zalegalizowaniu wszystkie elementy systemu sterowania (CS), włączając zatwierdzone komponenty. Dane dotyczące niezawodności naszych podzespołów wyspy można uzyskać na zamówienie. Różnego rodzaju zastosowania zostały szczegółowo opisane w instrukcji technicznej dostępnej na naszej stronie internetowej.
  - Zgodnie z normą ISO 13849-2 komponenty standardowe i bezpieczeństwa produktu muszą być zasilane przez zasilacze SELV/PELV.
  - W przypadku zastosowania produktu w środowisku zawierającym pyły przewodzące, wodę lub inne media mogące spowodować wewnętrzne zwarcie elektryczne należy zastosować szafę sterowniczą lub odpowiednią obudowę.
- HU** A Zoned Power pneumatikus szigeték biztonságos kapcsolatos ellenőrzési rendszerek (SRP/CS) részeként használhatók, az ISO 13849 szabvány betartása mellett a 3. kategóriás/PLd rendszerig, amennyiben a megfelelő külső biztonsági ellenőrzéssel (például: megfigyelés, időzítés, impulzus teszt, stb.), valamint az összes kapcsolódó biztonsági szabvány betartásával használják őket. Az ISO 13849 értelmében, a végfelhasználónak, illetve a harmadik fél szervezetnek minden vezérlőrendszer (CS) fel kell mérnie, és igazolnia kell, beépítve a bevált alkatrészeket. A pneumatikus sziget alkatrészeinek megbízhatósági adatai kérésre megadhatók. A weboldalunkon elérhető műszaki kézikönyvünkben megtalálható a különböző típusú alkalmazások részletes leírása.
  - Az ISO 13849-2 szabvány értelmében a termék biztonsági alkatrészeit SELV/PELV tápfeszültséggel kell ellátni.
  - Ha a terméket vezetéképés port, vizet vagy egyéb, belső rövidzárlatot okozó közvetítő anyagot tartalmazó környezetben használják, akkor szekrényt vagy megfelelő burkolatot kell alkalmazni.
- RU** В качестве элемента системы контроля, связанной с безопасностью (SRP/CS), можно использовать пневмоострова с зонированным питанием согласно стандартам ISO 13849 вплоть до категории 3/PLd, если это сочетается с соответствующими внешними мерами по контролю безопасности (напр. наблюдение, тагирование, импульсный контроль и т. д.) и с соблюдением всех связанных с ними стандартов безопасности. Согласно ISO 13849 конечный пользователь или сторонняя организация обязаны провести оценку и сертификацию системы контроля в целом, включая проверенные компоненты. Данные по надежности компонентов острова предоставляются по требованию. Различные виды применения перечислены в техническом руководстве на нашем сайте.
  - Согласно стандарту ISO 13849-2 и требованиям к безопасности, на элементы следует подавать электропитание БСНН/ЗСНН.
  - При эксплуатации в среде, содержащей проводящую пыль, воду или иное вещество, способное вызвать внутреннее короткое замыкание, следует воспользоваться шкафом или соответствующим кожухом.
- KZ** Қуатты қамтамасыз ететін, аймақтарға белінген пневматикалық блоктар қауіпсіздікті қамтамасыз етуге арналған тиісті элементтермен (мысалы, бақылау, уақытты белгілеу, импульс сынағы, т.б.) бірге пайдаланылса және барлық байланысты қауіпсіздік стандарттарына сәйкес пайдаланылса, оларды ISO 13849 стандартына сәйкес 3-санат/PLd деңгейіне дейінгі қауіпсіздікке қатысты басқару жүйесінің (SRP/CS) бір бөлігі ретінде пайдалануға болады. ISO 13849 стандартына сәйкес, тұтынушы немесе үшінші тарап ұйымның тексерілген құрамдастарды қоса, басқару жүйесінің (БЖ) жұмысын түгел бағылап, нұсқаландыру қажет. Блок құрамдастарының сенімділігі туралы деректер сұрау бойынша беріледі. Қолдану түрлері біздің веб-сайтта қолжетімді техникалық нұсқаулықта толық сипатталған.
  - SO 13849-2 стандарты бойынша өнім қауіпсіздігінің бөлшектері SELV/PELV қуат блогынан қуатпен қамтамасыз етілуі тиіс.
  - Өнім электр өткізгіш шаң, су немесе қысқа тұйықталуға себеп болатын қандай да бір зат бар ортада пайдаланылса, шкаф немесе тиісті жабық жерді пайдалану керек.

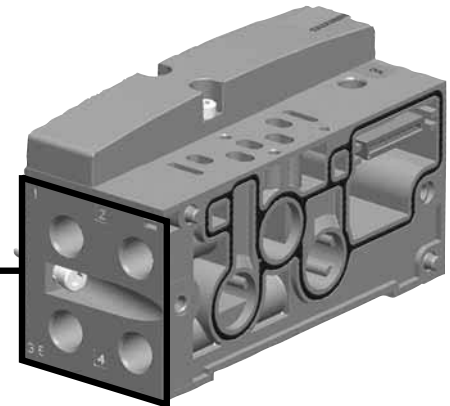
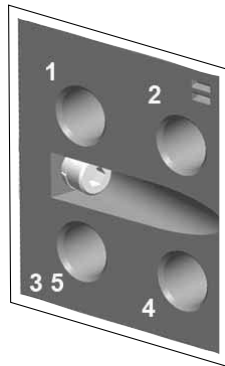

8 G 502AZ M 22 M A00 2 1 0 K 3

