

Gain better understanding
and insight into your plant data.



Plantweb™ Insight

Discover how you can make the most of plant sensor data with real-time actionable analysis of your operations.



Today's technology delivers more data than ever before — but are you getting the most out of all this data?

Data is essential in making critical decisions for your operations and ensuring optimal operating conditions. When you are burdened with performing tedious manual rounds or unable to analyze your data quickly, essential information slips through your fingers. Without quick and accurate data analysis, it can be difficult to prioritize maintenance and identify potential hazards or failures, putting the safety, reliability, and compliance of your facility at risk.

Professionals in the automation industry say the main reasons they are collecting data are for process improvements (74.56 percent), diagnostics and predictive maintenance (67.58 percent), and quality control (51.37 percent).*



Over 50 percent of businesses report that they have too much data to be able to analyze it efficiently though, and 44 percent report that they could do a better job at analyzing their data.**



* "Are You Data-Driven?" Industry Survey by AutomationDirect, CFE Media and Putman Media (participants were able to select multiple reasons)
** Strategy Analytics IoT 2016 Deployment and Trends Usage Survey



When you have access to instant, easy-to-read analysis of your key operational assets, you gain better understanding of your data. This knowledge allows you to make quick, critical decisions to increase operational efficiency, safety, and compliance.

Plantweb Insight offers instant access and visibility to key assets, enabling you to make better, faster decisions for your operations.



Engineered to work through plant sensors and networks, Plantweb Insight is able to provide real-time analysis of key asset data. This solution seamlessly integrates into your existing systems, offering automatic data interpretation. With Plantweb Insight, you can leverage data to reduce risk, save time, and improve efficiency and safety.



Plantweb Insight brings it all together by managing your facility data and providing data interpretation that enables you to make the critical decisions necessary to improve operational performance and safety.

Gain better understanding of facility data with real-time analysis.

Make manual rounds and inconsistent data communication a thing of the past. With Plantweb Insight, you have instant data interpretation of key asset health. Engineered with pre-built, industry-accepted analytics, this solution transforms sensor data into actionable insights.

Safely access your data anywhere.

The web-based platform allows you to securely access your data from anywhere at any time. Plus, the human centered design interface offers consistent and intuitive navigation across the apps.

Shift strategy from reactive to predictive.

With real-time visibility to key asset health, you can avoid potential safety hazards as well as better prioritize your maintenance. When you can spot abnormal situations before they become potential problems and prevent failures before they occur, you not only improve facility safety, but ensure your operations meet compliance and regulatory standards.

Easily integrate pre-built analytics into your current systems.

This solution seamlessly integrates with your existing wireless infrastructure, allowing you to expand the capabilities of your current system. Plantweb Insight can be used for any size operation.

Steam Trap Application: Continuous steam trap monitoring

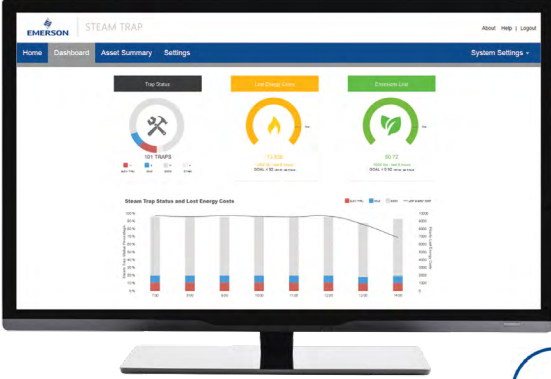

How It Works

The Plantweb Insight Steam Trap application determines the online health status of your steam traps by verifying if a trap is in failure mode. This is calculated using a status algorithm established by years of industry experience and analytics.

With this application, you can view trending of past health, emissions, and energy loss on a per trap basis, and track impact set against key performance objectives.

The application utilizes data from the Rosemount™ 708 Wireless Acoustic Transmitters to continuously determine steam trap status. This includes identifying steam trap failures (blow through, flooded, plugged) and inactivity.

Remove guess work

Better prioritize maintenance with calculated insights from a steam trap status algorithm based on decades of process experience and analytics.

Cut energy costs

Real-time monitoring clearly displays economic and environmental impact in terms of excess energy costs and emissions loss.

Improve efficiency

Quickly identify any steam traps that require attention: Blow through, plugged, and flooded failure modes are immediately displayed.

Meet Challenges with Increased Process Insight

Steam Trap Failures Have a Major Business Impact



Steam traps are typically only audited once a year, leaving plants vulnerable for long periods of time.



Expected steam trap failure rates range from 12.5% to 25% every year.*



5-10% of total energy cost are typically lost through leaking steam traps.**

Avoid Costly Damage with Greater Visibility



Continuous steam trap monitoring helps identify failures in real-time for quick repair and replacement.



Wireless provides a cost effective, reliable solution and non-intrusive transmitters make installation quick and easy.

Rosemount 708 Wireless Acoustic Transmitter



- Ultrasonic acoustic level and temperature readings
- FM and CSA Class 1 Div 1 approvals
- Fast and easy to install and maintain
- Directly mount without cutting or changing pipe configuration
- No calibration
- Intrinsically safe power module with 10+ year battery life

* Risko, J., Understanding Steam Traps, Chemical Engineering Progress, Feb 2011
 ** U.S. Department of Energy

Pump Application: Gain clarity with pump health status and alerts

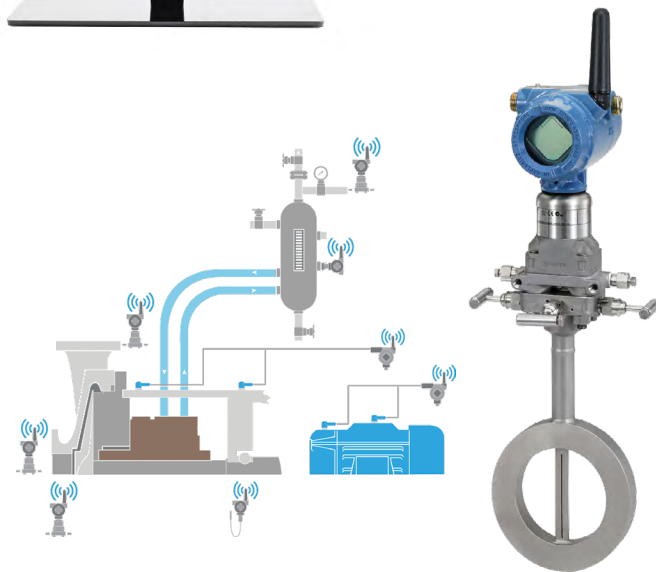

How It Works

The Plantweb Insight Pump application offers in-depth monitoring of fixed-speed pumps by providing an aggregated view into the health of all assets. Status and alerts are calculated by pre-built algorithms based on years of experience and industry-vetted analytics.

The predictive diagnostics and alert weights of this solution enable better prioritization of pump maintenance, allowing users to mitigate recordable incidents and quickly identify any assets requiring attention.

Increase visibility

Using a multi-measurement approach, continuous pump monitoring and analysis offers you greater visibility into your process and equipment conditions.

Reduce costs

Wireless capability easily integrates with your existing systems and provides a cost-effective approach for missing measurement points.

Be proactive

Predictive diagnostics and analytic tools allow for preventive maintenance and prioritization.

Impact of Pump Failures



Statistically, pumps will fail or suffer degraded operation every 12 months.*



Pump failures can cause process upsets and downtime, taking hours or days to recover to normal operations.



Reactive maintenance results in 50% higher costs than preventative maintenance.**



Poor equipment reliability impacts HSSE in the form of safety incidents, regulatory fines and process shut downs.

Comprehensive Monitoring for Enhanced Visibility

Seal Monitoring conforms to API Standard 682 for pressure and level solutions.

Strainer Monitoring utilizes differential pressure across the strainer to identify plugging.

Cavitation Monitoring offers statistical analysis of process and vibration data to detect cavitation.

Vibration Monitoring provides early indication of vibration faults.

Multi-Measurement Approach

Emerson's wireless portfolio helps you establish all the necessary critical measurement points.

Pressure



Pressure and DP Level Transmitters

- Strainer Plugging
- Discharge Pressure Variation
- Seal Pressure
- Suction Pressure

Level



Level Transmitters and Switches

- Seal Level

Vibration



AMS Wireless Vibration Transmitter

- Vibration and PeakVue (early indicator)
- Bearing Temperature
- Premature Wear
- Cavitation

Hydrocarbon Leak Detection



Rosemount 702 Discrete Transmitter with Liquid Hydrocarbon Detection

- Hydrocarbon Leak Information
- Leak Warning

Heat Exchanger Application: Increase efficiency with better understanding

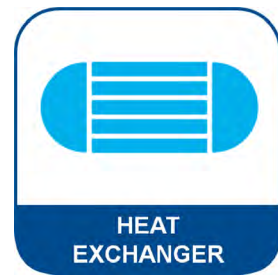

Reduce production loss

Predictive and continuous heat exchanger monitoring helps optimize cleaning for enhanced production and energy efficiency.

Cut maintenance costs

Automated monitoring reduces costs caused by reactive maintenance.

Proactively monitor KPIs

Continually calculate and track key performance indicators like fouling, heavy duty, and heat transfer coefficient.

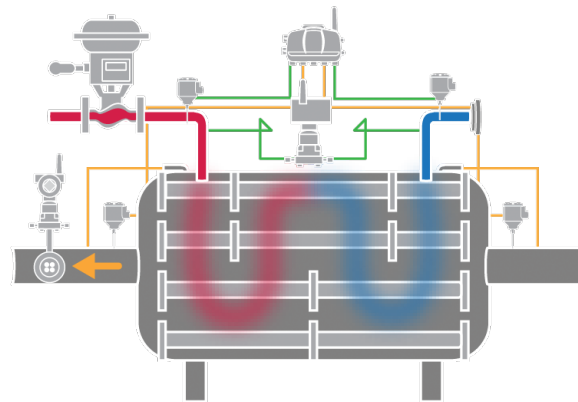

How It Works

The Plantweb Insight Heat Exchanger application provides in-depth monitoring of shell and tube heat exchangers by analyzing plant sensor data gathered through existing infrastructure.

Leveraging pre-built algorithms based on decades of process experience and industry-vetted analytics, this solution delivers reliable predictive diagnostics.

Insufficient Monitoring Has Impact on Operations

Heat Exchanger Failures Have a Major Business Impact



Unnoticed or increased heat exchanger fouling causes degraded performance and energy efficiency.



Reactive maintenance results in 50% higher costs than preventative maintenance.*



Poor equipment reliability impacts HSSE in the form of safety incidents, regulatory fines and process shut downs.

Complete Insight of Heat Exchanger Conditions

Avoid Costly Damage with Greater Visibility



Fouling Monitoring provides early indication of fouling by comparing current heat transfer coefficient with baseline (newly cleaned).



Heat Duty Monitoring quickly recognizes when heating requirements change.



Cleaning Recommendations are based on high fouling and high dP or lost energy costs.

Rosemount Measurement Solutions

Get a complete picture of your processes by setting up a Pervasive Sensing™ network.



Rosemount 848T Wireless Temperature Transmitter

- Monitors four independent temperature inputs
- Configurable for RTD, thermocouple, ohm, millivolt and 4-20 mA inputs



Rosemount X-well™ Technology

- Non-intrusive point solution for process temperature
- Uses pipe characteristic, ambient temperature, and pipe surface temperatures to calculate process temperature



Rosemount Wireless Differential Pressure Transmitter

- Full portfolio of differential pressure transmitters
- Monitors differential pressure across hot and cold sides



Rosemount Wireless Differential Pressure Flow Transmitter

- Best-in-class solution for accurate flow measurements
- Cold and hot side flow used for fouling calculations

*NPR A Reliability and Maintenance Conference

Air Cooled Heat Exchanger Application: Make intelligent decisions about your ACHE and fans

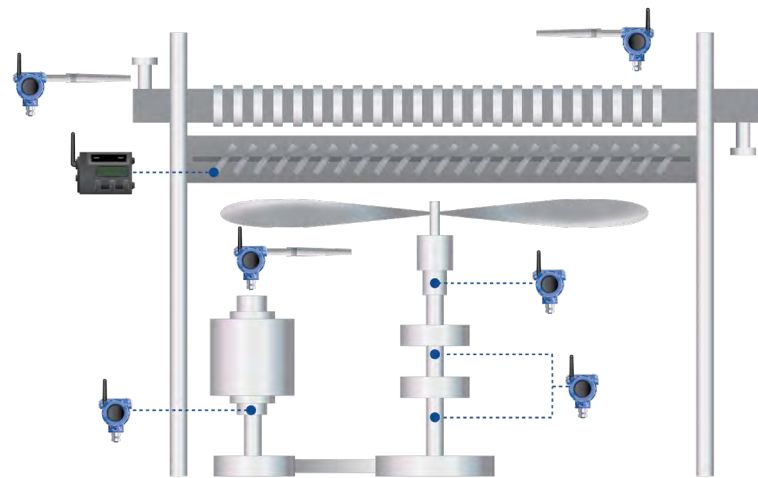

Reduce slowdowns

Predictive and continuous air cooled heat exchanger monitoring helps reduce unexpected failures and process shutdowns.

Cut maintenance costs

Automated monitoring reduces costs caused by reactive maintenance and manual rounds.

Pre-built models save valuable time

With access to pre-built strategic interpretation analytics, personnel no longer have to sort through large data sets.

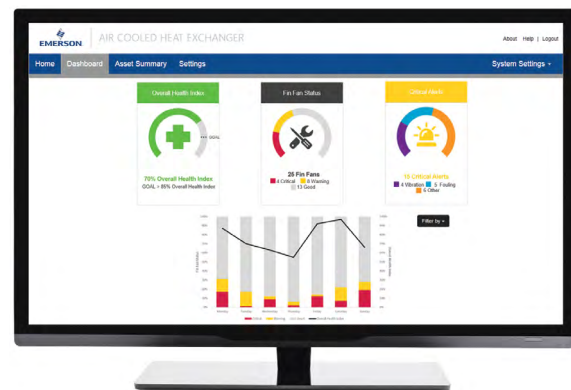

How It Works

The Plantweb Insight Air Cooled Heat Exchanger application provides in-depth monitoring of air cooled heat exchangers, fin fans, by analyzing wireless sensor data gathered through existing infrastructure.

Leveraging pre-built algorithms based on decades of process experience and industry-vetted analytics, this solution delivers reliable predictive diagnostics.

Common Threats to Air Cooled Heat Exchangers

Exchanger Fouling

Limited cooling is an indication of exchanger fouling. This can result in reducing the cooling capacity of the exchanger, leading to a throughput reduction. This can also cause products heading to storage tanks to be too hot or other process impacts.

High Vibration and Bearing Temperature

Increasing motor or fan vibration and bearing temperature can result in belt and coupling failure or can cause fan blades to stop, reducing the cooling capacity of the exchanger and throughput reduction. Other process, safety, and environmental impacts can occur as well.

Louver Mechanical Defects

Faulty louver position can result in restricting airflow and cooling capacity reduction, leading to overall throughput reduction and other potential process impacts.

Monitoring Your Air Cooled Heat Exchanger

Install Wireless devices for better visibility across your facility.



Rosemount 848T Wireless Temperature Transmitter

- Monitors four independent temperature inputs
- Configurable for RTD, thermocouple, ohm, millivolt and 4-20 mA inputs



Rosemount X-well Technology

- Non-intrusive point solution for process temperature
- Uses pipe characteristic, ambient temperature, and pipe surface temperatures to calculate process temperature



AMS Wireless Vibration Monitor

- Vibration and PeakVue (early indicator)
- Bearing temperature and premature wear



Fisher™ 4320 Wireless Position Monitor

- Equipment position with a percent of span plus on/off indication
- Monitors louver position for mechanical defect detection

Complete Insight of Air Cooled Heat Exchanger Conditions

Vibration Monitoring gives warnings of vibration and bearing faults, replacing manual rounds.

Heat Exchanger Fouling provides early indication of fouling using temperature readings.

Pitch/Louver Position Monitoring recognizes discrepancies in actual and expected position.

Wireless Pressure Gauge Application: Know before you go



Enjoy more flexibility

The “Know Before You Go” strategy enables users to remotely view pressure gauge readings and trends in order to stay updated on changing field conditions.

Improve workplace safety

With remote monitoring, you reduce manual rounds and keep personnel out of hazardous areas, improving facility safety.

Set to your specifications

Manual configuration of thresholds for alerts ensures you get the data you are looking for.

How It Works

The Plantweb Insight Wireless Pressure Gauge application monitors your wireless pressure gauges in a single, easy-to-use interface. This solution analyzes data acquired through plant sensors and existing infrastructure to provide real-time pressure status of all wireless pressure gauges.

This application also features device health indicators, which help effectively manage maintenance.

Meet Challenges with Increased Process Insight



Traditional gauges routinely fail, providing unreliable information without any indication. Basing important maintenance decisions on these faulty gauges can negatively impact plant safety and productivity.



The Rosemount Wireless Pressure Gauge has a robust design that resists common failures, delivers dependable information about plant equipment, and constantly informs users of its status.

Engineered to Optimize Data Communication



Industry-proven Rosemount pressure sensor technology replaces traditional mechanical components and delivers up to 10 years of battery life.



Innovative design provides overpressure protection and dual layers of process isolation to keep personnel safe and ensure reliable pressure readings.



WirelessHART® technology delivers reliable field data communications as frequently as once per minute.

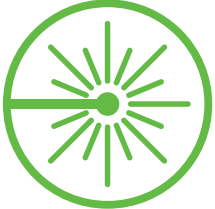

Local status indication allows personnel to have confidence in device health.

Engineered to Optimize Data Communication



For more information, visit [Emerson.com/Rosemount-Wireless-Pressure-Gauge](https://www.emerson.com/Rosemount-Wireless-Pressure-Gauge)

Pressure Relief Valve Application: Log PRV releases for compliance

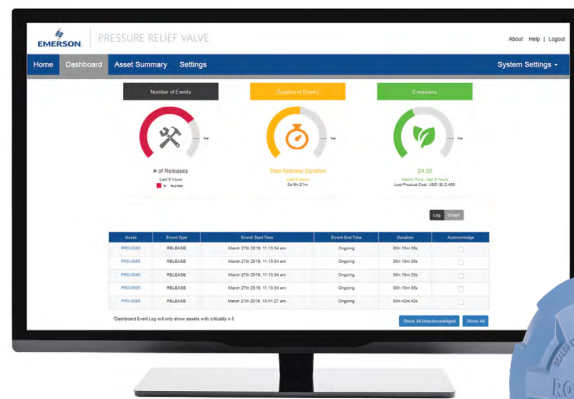

How It Works

The Plantweb Insight Pressure Relief Valve application determines when and where an event has occurred within your relief valve fleet. Utilizing machine learning techniques, the application algorithm identifies abnormal situations affecting operations allowing users to easily identify problem assets and areas to focus.

Within the software interface, users can view a consolidated event log, helping simplify regulatory compliance and reporting. Users can also gather information into production losses and emissions caused by pressure relief valve events.

Maintain compliance

Automatically log pressure relief valve releases to adhere to new safety and emissions regulations.

Utilize machine learning

Leverage data analytics and machine learning techniques to revolutionize the way pressure relief valve monitoring is performed.

Improve safety

Monitor relief events without manual rounds, keeping employees safe.

Impact of PRV Monitoring

Pressure Relief Valve Events Have a Major Business Impact



Both manual and traditional electronic monitoring of relief valves have proven costly and difficult.



Regulatory fines due to relief valve release can cost hundreds of thousands of dollars.



Leaking or simmering relief valves lead to significant loss of hydrocarbons or costly materials.



Continuous relief valve monitoring helps identify events and failures in real time for quick repair and replacement.

Wireless provides a cost-effective, reliable solution, and non-intrusive instruments make installation quick and easy.

Rosemount 708 Wireless Acoustic Transmitter



- Ultrasonic acoustic level and temperature readings
- FM and CSA Class 1 Div 1 approvals
- Fast and easy to install and maintain
- Directly mount without cutting or changing pipe configuration
- No calibration
- Intrinsically safe power module with
- 10+ year battery life

Wireless Infrastructure Applications: Effectively manage wireless networks and power modules

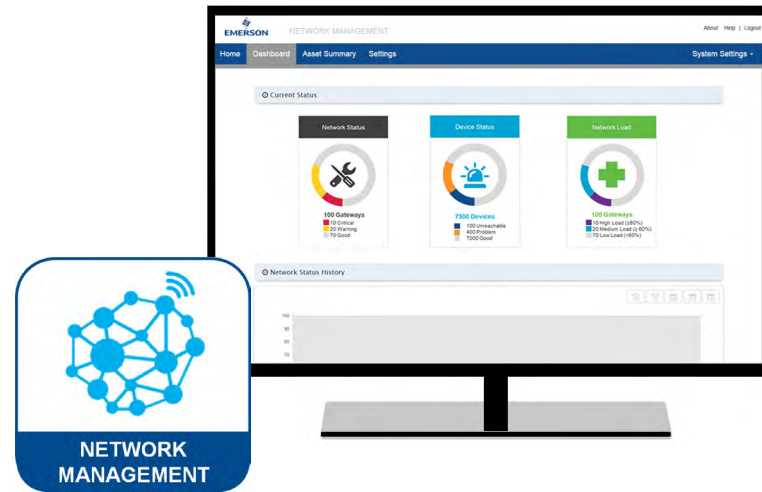

Manage networks

Growing numbers of networks are making troubleshooting and management difficult. Consolidate network diagnostics in one spot.

Troubleshoot faster

Identify problem areas in the network for quick and simple diagnoses. Visualize networks using the network diagram.

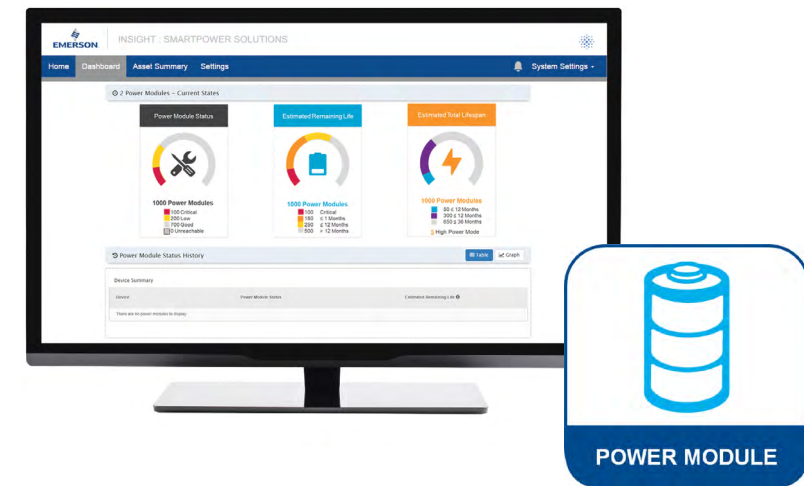

Plan Power Module replacements

Consolidate Power Module status in one view while benefiting from estimated remaining life calculations.

How It Works

The Plantweb Insight Network Management application offers users a consolidated view into network health. The application identifies shortcomings in meeting best practices. It also provides a network information and diagnostic summary. The network mesh diagram allows for visualization of networks and quick troubleshooting.

The Plantweb Insight Power Module Management application brings all Power Module indicators across multiple networks into a central location. Not only can users view the status of Power Modules, the application will provide an estimate of remaining life and alert users to high-consuming devices.

Network Management



Adhere to network best practices for improved reliability.

Troubleshoot faster by easily recognizing problem areas.

Utilize the network diagram to visualize networks and identify areas for improvements.

Emerson Wireless Gateways create self-organizing WirelessHART networks. Secure, robust, and infinitely configurable, this self-healing, mesh technology features data reliability of greater than 99% and ensures an interoperable, adaptive and flexible approach to wireless.

Power Module Management

View current status of all Emerson Power Modules.

Schedule maintenance with the total estimated remaining life calculation.

Identify high-consuming devices for possible reconfiguration.



Emerson SmartPower™ Modules are engineered with a robust and adaptable design that withstands harsh environments and allows you to choose the best mode of power for your application.

Location Application: Provide a safe and secure environment with Location Awareness solutions

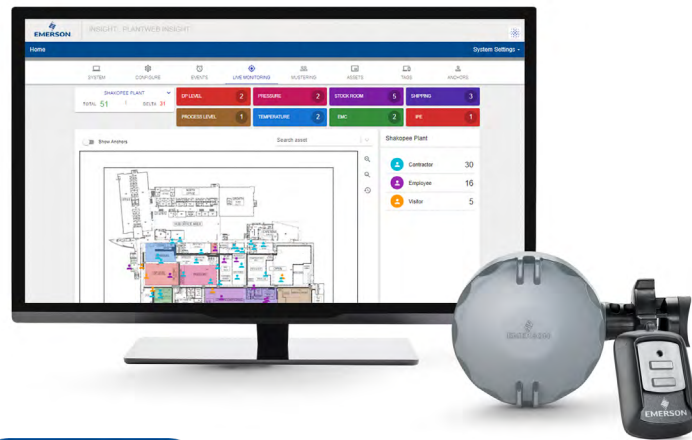

Geofencing

Digitally create designated work zones and off-limits areas, for configured groups such as, employees, visitors or contractors to receive an alert when a boundary is crossed to keep personnel safe and contractors accountable

Safety Mustering

During an emergency or drill, know that your personnel are safe and accounted for at designated muster and assembly points, the application will trigger an emergency alert if they're not accounted for in the configured allotment time

Safety Alerts

Personnel equipped with a Location Tag can press their Tag's button and initiate an emergency safety alert in the application should they be involved in or witness an emergency situation

How It Works

The Plantweb Insight Location application brings your facility and location data together through one streamlined interface. Manage your tags, geofencing, safety mustering and safety alerts all through

this state-of-the-art software. Evolve the digital transformation of safety in your facility by enabling a quicker and more direct emergency response with Emerson's Location Awareness solution.

Emerson's Location Awareness Solution

Location Tag



- Rechargeable battery
- Up to 6-week battery life while operating at 10 hours/day
- Qi certified wireless charger
- <0.1 pounds (45 g)
- 2x3" (51x78mm)
- Zone 0, Class 1 Div 1
- Flexible body-worn options
- User assistance button



Location Anchor

- Fully wireless
- Configurable update rate based on system size, 32 sec to 1 hour
- Up to 5-year battery life at 32 sec update rate
- Replaceable Battery
- Less than 2 pounds (1kg)
- ~5.5" (139mm) diameter
- Zone 0, Class 1 Div 1
- Placed in grid pattern
- Flexible mounting options

Emerson's Location Awareness Solution

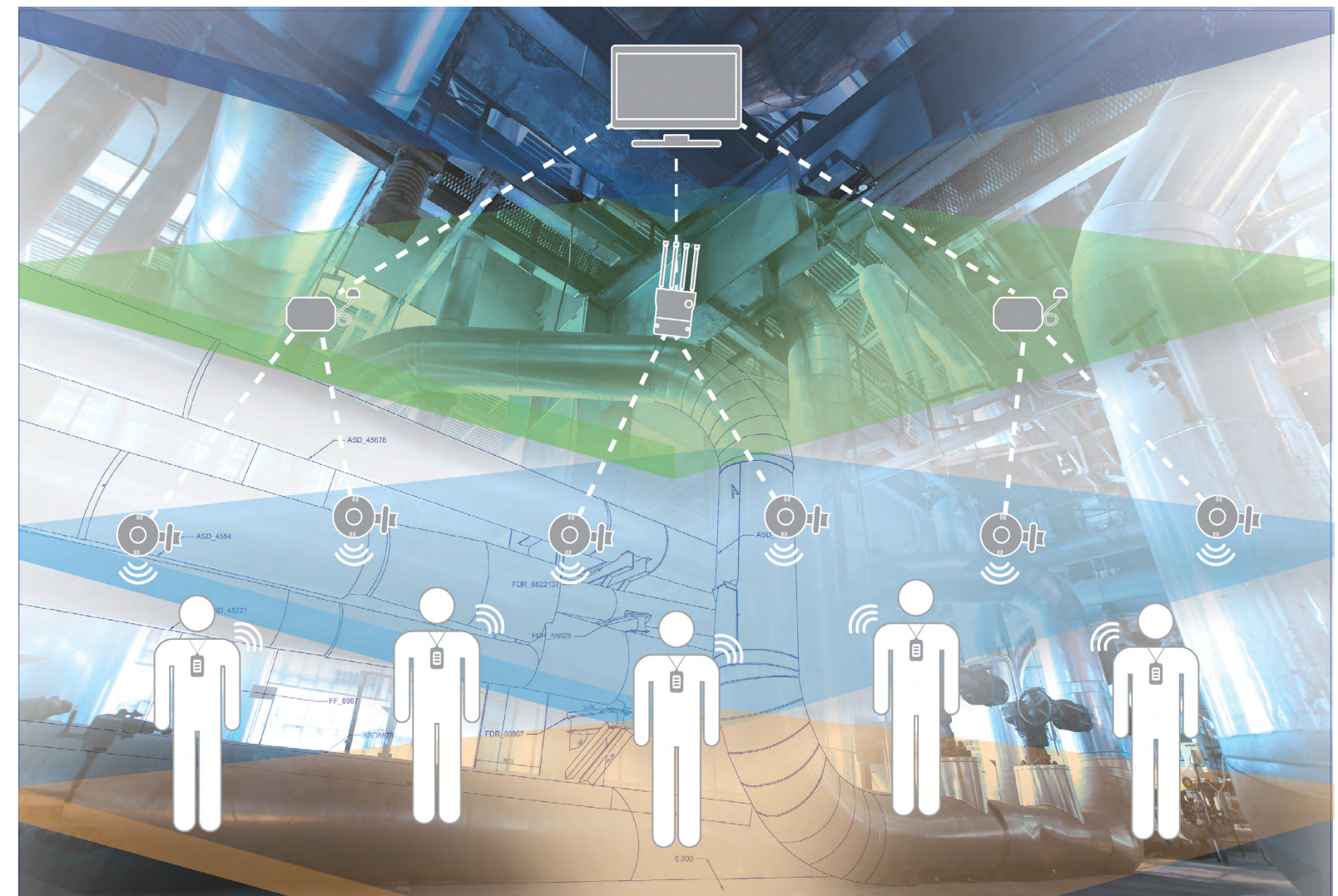

Cooling Tower Application: Track effectiveness and health of cooling tower systems

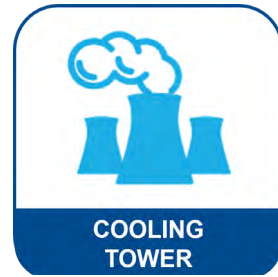
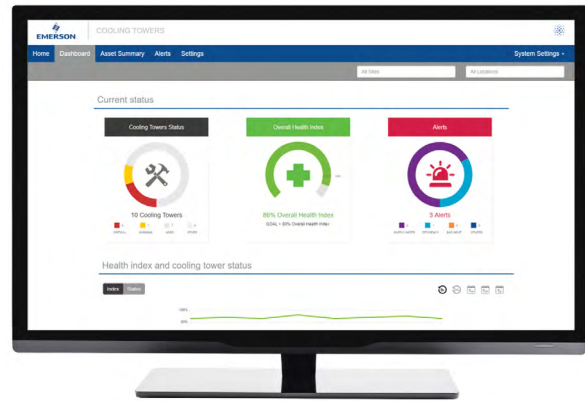

Monitor cooling tower effectiveness

Gather visibility into remaining heat removal capacity with continuous temperature measurements.

Reduce corrosion and build-up

Conductivity and pH sensors easily identify degrading water quality before it leads to detrimental equipment corrosion and fouling.

Recognize water usage

Track key trails of water usage and how much evaporation is occurring.

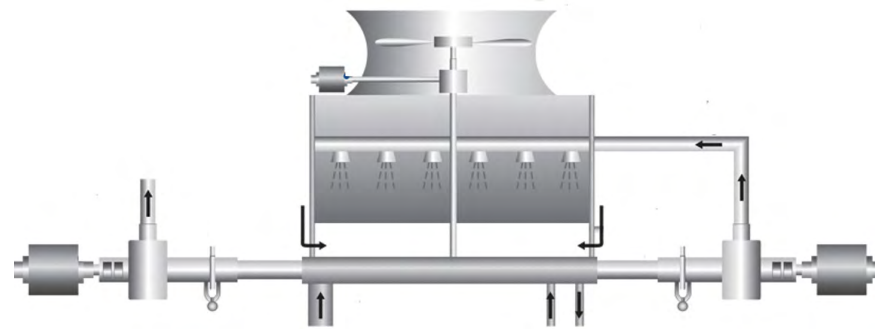

How It Works

The Plantweb Insight Cooling Tower application uses process data to determine the overall health of this critical asset.

This application utilizes key temperature, flow, level, and analytical information to identify abnormal situations that affect the long-term reliability and efficiency of cooling water systems.

Valuable Information Provided Through Application Analytics

Cooling Tower Effectiveness: Monitor cold water supply, return, and air temperature.

Water Usage and Evaporation: Gain key information from monitoring supply, blowdown, makeup, and recirculation flow points.

Water Degradation: Monitor water quality with pH and conductivity measurements.

Fan Health: The ACHE application provides built-in vibration analysis, and alignment information.

Pump Health: The Pump application provides built-in vibration analysis, seal failure detection, cavitation detection, and strainer plugging.

Rosemount Measurement Solutions



Rosemount X-well Technology

- Non-intrusive point solution for process temperature
- Uses pipe characteristic, ambient temperature and pipe surface temperatures to calculate process temperature



Rosemount 3308 Wireless GWR Transmitter

- Monitor water basin level for overflow or undersupply conditions



Rosemount Wireless Differential Pressure Flow Transmitter

- Best-in-class solution for accurate flow measurements



- For rotating equipment, the Cooling Tower applications links to the Pump and Air Cooled Heat Exchanger applications for a holistic view of cooling tower health

Inline Corrosion Application: Gain integrity insights with corrosion alerts and heatmap

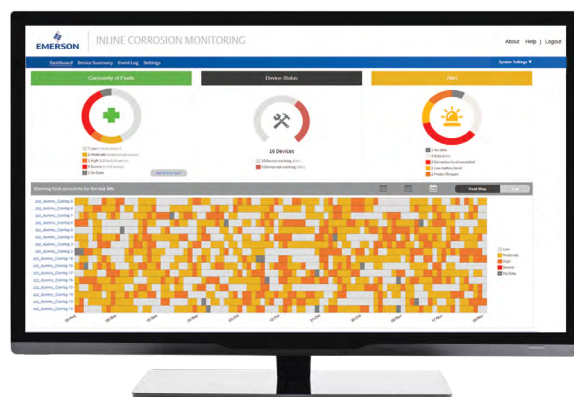

How It Works

The Roxar™ Electrical Resistance (ER) probe / Roxar Linear Polarization Resistance (LPR) probe and Roxar wireless transmitter feed the Plantweb Insight Inline Corrosion application with data (metal loss and corrosion rate). The

software then calculates insights such as corrosion rate trends, corrosivity of fluid indication levels, electrical resistance (ER) probe expected life-span, and battery status.

Increase visibility

Continuous online corrosion monitoring enables users to remotely view corrosion rate readings and corrosion trends in order to stay updated on changing field conditions. An intuitive heatmap is displayed with intelligence on corrosivity of fluid levels per tag, based on the NACE® standard.

Improved workplace safety

With remote monitoring you reduce time spent on data collection, thus minimizing your time spent in hazardous areas. It also reduces the need for site adaptations (scaffolding, etc.).

Improve efficiency

Quickly identify changes in the corrosivity behavior of the process fluid and improve response time for required mitigation.

Meet Challenges with Increased Process Insight



Uncontrolled internal corrosion may lead to catastrophic accidents.



Traditional corrosion monitoring systems require pre-defined chemical injection rates that are often not correctly tuned with the actual corrosion rate, leading to additional cost and stock of chemicals.



Data from traditional corrosion monitoring systems is difficult to interpret and often require a dedicated corrosion specialist to analyze and provide an action plan.



Continuous internal corrosion monitoring helps prevent potential risks of material failure.



Real-time monitoring contributes to the optimal consumption of chemicals, as well as extend equipment life, by implementing corrosion control before damage takes place.



The application provides a user-friendly interface that displays already engineered values, including a unique heatmap, which assists with faster and simpler decision-making.

Roxar Complete Internal Corrosion Measurement System



Roxar CorrLog Wireless Transmitter

- Instrument reads Electrical Resistance Probes (ER)
- Instrument reads Linear Polarization Probes (LPR)
- 24-bit Instrument Resolution
- Measurement Intervals from 2 min up to 24 hours
- Intrinsically Safe certified



Roxar Retrievable Electrical Resistance (ER) Probe



Roxar Retractable Electrical Resistance (ER) Probe



Roxar Retrievable Linear Polarization Resistance (LPR) Probe



Roxar Retractable Linear Polarization Resistance (LPR) Probe

Non-Intrusive Corrosion Application: Best-in-class wall thickness data, vizualization, and analytics

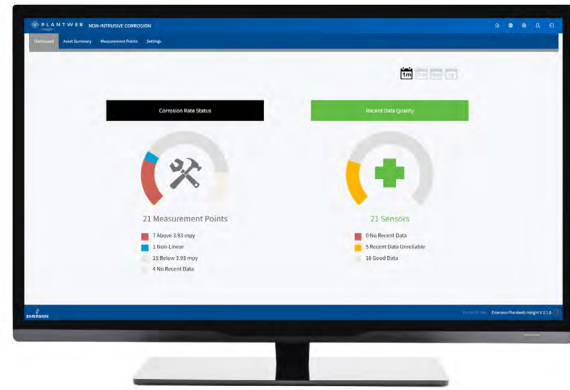

How It Works

The Plantweb Insight Non-Intrusive Corrosion application monitors Rosemount Wireless Permasense sensors to provide users with critical insights on the condition of their assets. This helps inform users on predictive maintenance strategies to optimize plant performance. Within the

software interface, users can gain real-time advanced analytics to assess the impact of profitability-driven process changes. This allows informed decision making to counter the ever-changing demands of the modern process industry.

Ensure profitability

Enhance decision making with real-time corrosion and erosion data and insights designed to maximize asset capability and improve profitability.

Improve operations

Online optimization and validation of chemical corrosion inhibition programs ensure corrosion is kept within tolerable levels and spend is controlled.

Increase process and personnel safety

Avoid loss of containments and ensure process safety through online monitoring with early detection of corrosion and erosion events.

Thickness Data for Root Cause Analysis and Predictive Maintenance

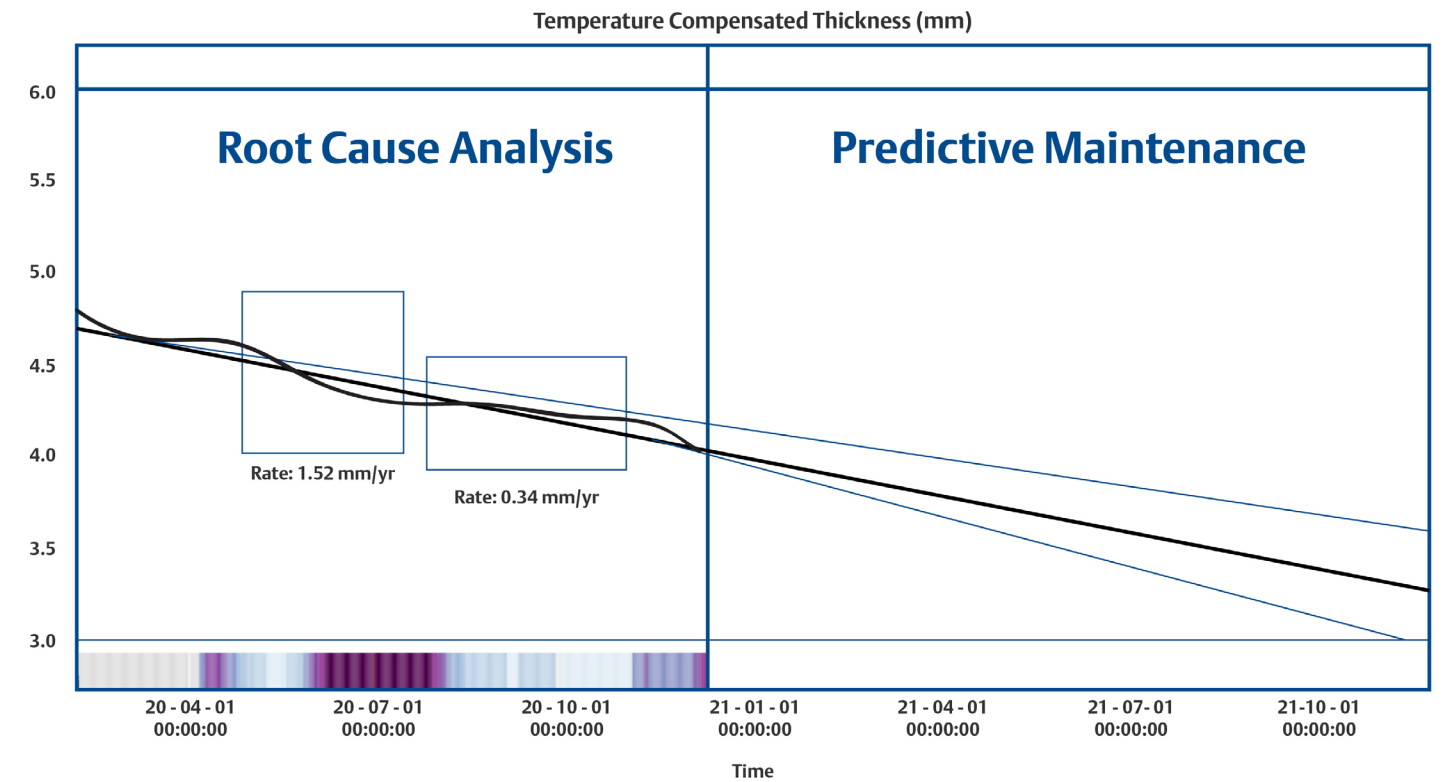

Rosemount Wireless Permasense Corrosion and Erosion Monitoring System



Rosemount Wireless Permasense Sensors

- Ultrasonic thickness sensors with temperature compensation and *WirelessHART* radio.
- Produces online point measurements which feeds both root cause analysis and predictive corrosion visualisation.

Inline Corrosion Application

- Compliments the Plantweb Insight Non-Intrusive Corrosion application showing the corrosivity of process fluid, allowing users to assess both the risk and impact of corrosion on their assets.

Connected Lighting Application: Save energy and extend lighting fixture life in harsh and hazardous environments



How It Works

The Plantweb Insight Connected Lighting application commissions groups of connected lighting on an uploaded image of the facility. Utilize pre-programmed controls or create custom controls to keep lights on when operators

Optimize lighting levels

Adjust the lumen output of luminaires as the needs of the space change, design lighting controls based on motion or illuminance, and implement a daily schedule for continuous monitoring

Simplify lighting maintenance

Increase workforce safety by providing continuous remote monitoring of lighting systems before operators enter harsh and hazardous environments

Review energy analytics

Review energy history from the previous year to optimize Connected Lighting systems in the future

are present. Simplify maintenance planning of the connected lighting system with device health indicators and history.

Flexible Lighting Controls Fit Every Location

Occupancy

Detects motion of human sized objects



- Passive Infra-Red Detection
- Triggers all grouped lights to max brightness
- Selectable Fresnel lens focuses detection area size

Up to 40 ft detection distance

Daylight Harvesting

Sunlight adjusts luminaire brightness



- Measured natural light automatically trims light output
- Maintain minimal light levels in specific locations
- Beneficial for both indoor and outdoor locations

Adjustable output

Scheduling

Time based controls

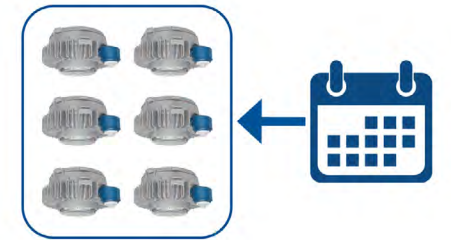

- Schedule up to four time periods per day per group
- Network time stamp keeps all luminaires in sync
- Best for regular use locations like parking lots or streets

Create unique group schedules

Appleton Connected Lighting



Appleton™ Mercmaster Connected LED Luminaires

- Industry leading LED luminaire with integrated sensors for use in harsh and hazardous locations
- Hazardous certifications in Class 1, Div 2; Zone 2; Industrial
- Mounting height up to 40 feet
- Integrated motion and illuminance sensors
- WirelessHart Connectivity
- Mounting adapters ensure compatibility with competitor hoods



Appleton Wireless Motion Sensor

- Detect motion in hard to access areas
- Integrated motion and illuminance sensors
- Up to 10-year battery life
- Flexible mounting connection
- Intrinsically safe design

Improve operations with strategic data analysis.



Plantweb Insight is focused on monitoring the health of plant assets and provides the strategic data interpretation and analysis needed to prioritize maintenance and make informed decisions.

Rosemount World Headquarters
Emerson Automation Solutions
6021 Innovation Blvd.
Shakopee, MN 55379, USA
+1 800 999 9307 or +1 952 906 8888
+1 952 949 7001
RFQ.RMD-RCC@Emerson.com





North America Regional Office
Emerson Automation Solutions
8200 Market Blvd.
Chanhassen, MN 55317, USA
+1 800 999 9307 or +1 952 906 8888
+1 952 949 7001
RMT-NA.RCCRFQ@Emerson.com

Latin America Regional Office
Emerson Automation Solutions
1300 Concord Terrace, Suite 400
Sunrise, FL 33323, USA
+1 954 846 5030
+1 954 846 5121
RFQ.RMD-RCC@Emerson.com

Europe Regional Office
Emerson Europe GmbH
Neuhofstrasse 19a P.O. Box 1046
CH 6340 Baar
Switzerland
+41 (0) 41 768 6111
+41 (0) 41 768 6300
RFQ.RMD-RCC@Emerson.com

Asia Pacific Regional Office
Emerson Automation Solutions
1 Pandan Crescent
Singapore 128461
+65 6777 8211
+65 6777 0947
Enquiries@AP.Emerson.com

Middle East and Africa Regional Office
Emerson Automation Solutions
Emerson FZE P.O. Box 17033,
Jebel Ali Free Zone - South 2
Dubai, United Arab Emirates
+971 4 8118100
+971 4 8865465
RFQ.RMTMEA@Emerson.com

-  [Emerson.com/Rosemount](https://www.emerson.com/Rosemount)
-  [Facebook.com/Rosemount](https://www.facebook.com/Rosemount)
-  [LinkedIn.com/company/Emerson-Automation-Solutions](https://www.linkedin.com/company/Emerson-Automation-Solutions)
-  [Twitter.com/Rosemount_News](https://twitter.com/Rosemount_News)
-  [YouTube.com/user/RosemountMeasurement](https://www.youtube.com/user/RosemountMeasurement)

The Emerson logo is a trademark and service mark of Emerson Electric Co.
Rosemount and the Rosemount logotype are registered trademarks of Rosemount Inc.
All other marks are the property of their respective owners.

© 2021 Emerson. All rights reserved.

00803-0100-4541, RevDA



CONSIDER IT SOLVED™