



Rosemount™ Annubar™
Flow Meter Series

The Value of Innovation, Realized



Insertion Technology, Simplified.

Averaging Pitot Tube (APT) technology reduces the total cost of ownership of the flow measurement by lowering installation and energy costs. The savings become even greater as the line size increases. Rosemount Annubar flow meters lower installed costs and simplify installation.

Lower Operating Costs. Maximize Energy Savings.

During use, Rosemount Annubar flow meters reduce operational expenditures. The less constricting design creates less permanent pressure loss than virtually any other DP flow technology. This translates into substantial energy savings by allowing lower pumping costs in liquids, lower compression costs in gas, and lower fuel costs in generating steam. The return on investment in energy savings from Rosemount Annubar technology can be achieved within six months.

RELATIVE ANNUAL ENERGY COST COMPARISON

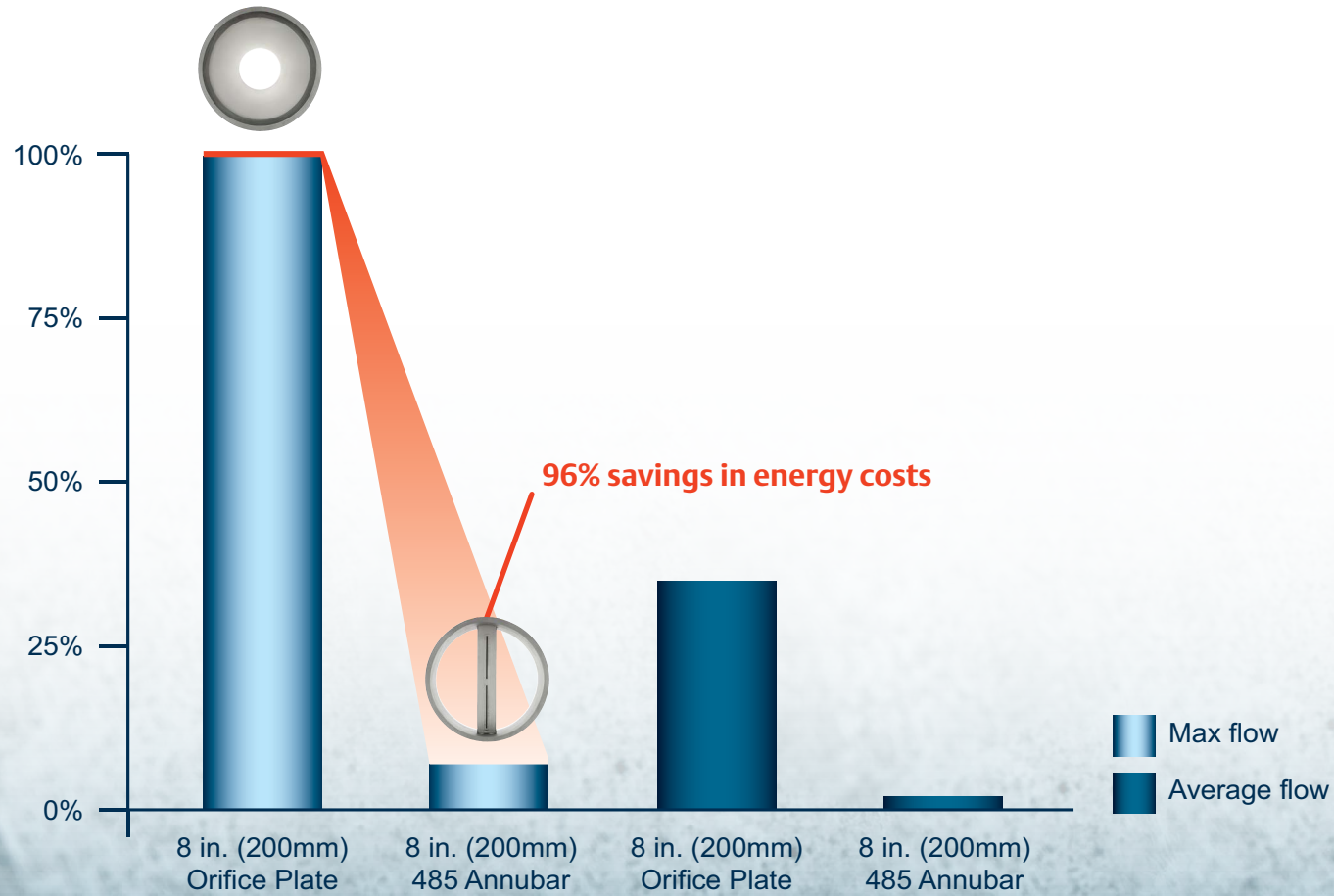

Lower Material Costs for Large Line Sizes

Rosemount Annubar Flow Meters require less material, which reduces the cost and weight of the flow meter installation. This makes the Annubar flow meter an economical choice for large line size installations.

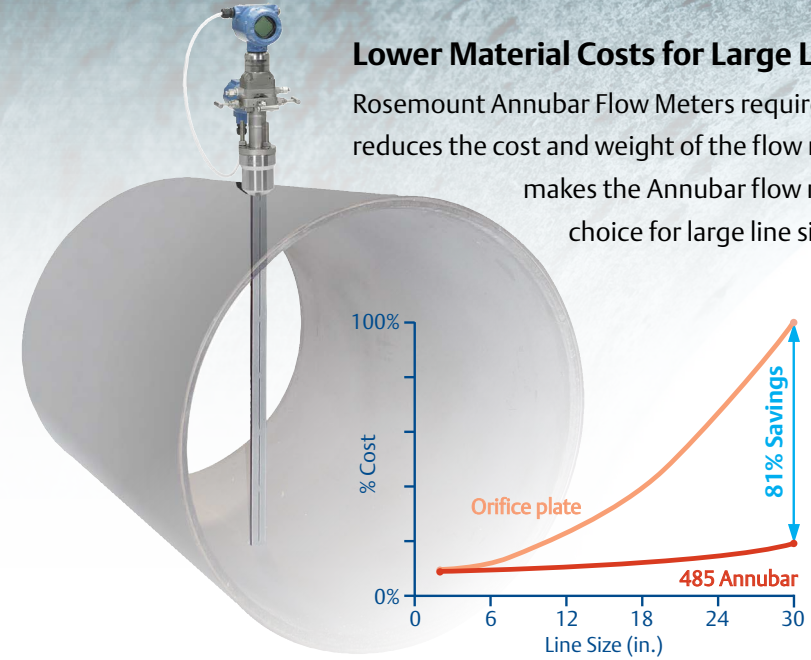

Reduce Installation Time and Cost

The patented Pak-Lok mounting option is simple and affordable. A complete flow meter installation is accomplished in three simple steps.

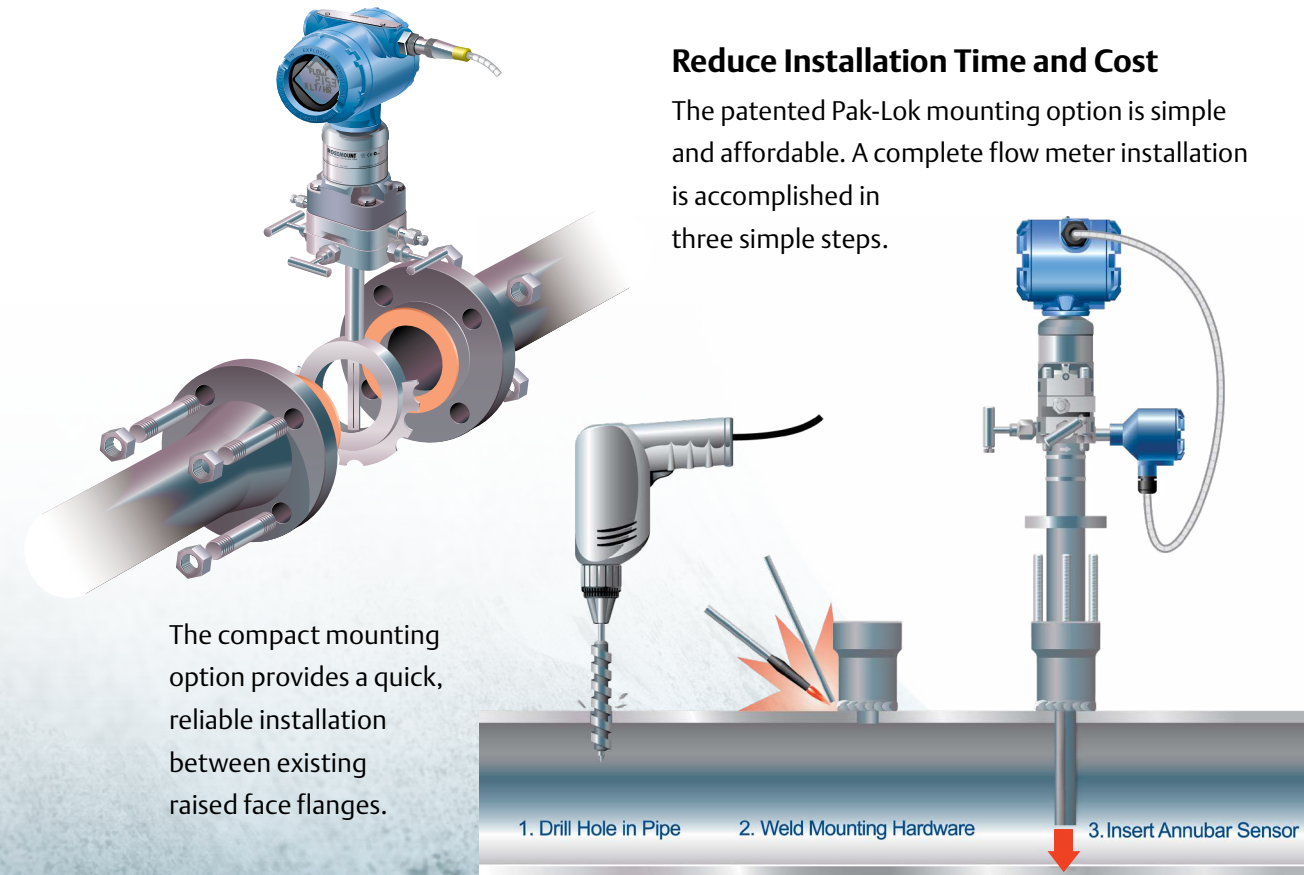

Annubar Technology, Optimized.

As the inventors of averaging pitot tube technology, Emerson understands that the shape of the sensor is fundamental to flow measurement performance. As a result, Annubar technology is the most innovative and rugged. These patented primary elements are designed to be resistant to wear, warp and plugging while achieving the highest accuracy and reliability.

Reduce Process Variability

LOW SIGNAL NOISE

Stagnation zones on the back side of the T-shaped Rosemount Annubar sensor are positioned to reduce the noise and measurement inaccuracies that lead to process variability.

Lower Energy Costs

MINIMIZED PERMANENT PRESSURE LOSS

Rosemount Annubar sensors create less blockage in the pipe, leading to a reduction in pumping, compression and fuel costs.

Save Installation Time and Cost

INTEGRAL THERMOWELL DESIGN

Add a temperature measurement without additional pipe penetrations or installation time and expense. The integrated thermowell of the Rosemount 485 sensor allows maintenance of the temperature sensor without process shutdown.

Enhance Measurement at Lower Flows

HIGHER SIGNAL STRENGTH

The flat upstream surface of the T-shaped Rosemount Annubar sensor creates a fixed separation point that improves performance over a wider flow range.

Decrease Measurement Error

+/-0.75% OF FLOW ACCURACY

The frontal slot design of the sensor measures 70% more of the velocity flow profile, increasing the accuracy of the measurement.



Severe Service Applications



Reliability in Challenging Applications

SOLID SENSOR CONSTRUCTION

The solid machined sensor design of the Rosemount 585 eliminates structural welds in the process flow enabling maximum strength. The sensor is available in a variety of materials for the greatest flexibility.

Simplified Bi-directional Measurement

SYMMETRICAL SENSOR DESIGN

Rosemount 585 Annubar flow meters can be used to measure bi-directional flow eliminating the need for two flow meter assemblies. Options for dual direct mounted transmitters make installation simple and cost effective.

Best Practices, Redefined.

Rosemount Annubar flow meters arrive fully assembled, configured, and leak tested. It is the only flow meter that delivers real-time mass flow with a single pipe penetration, reducing engineering, hardware, and installation expenses.

Traditional Practice

Traditional DP flow installations can require up to 10 individual components and multiple pipe penetrations to measure flow. Installing multiple components makes the measurement point susceptible to leaking, plugging, freezing, and measurement inaccuracies.

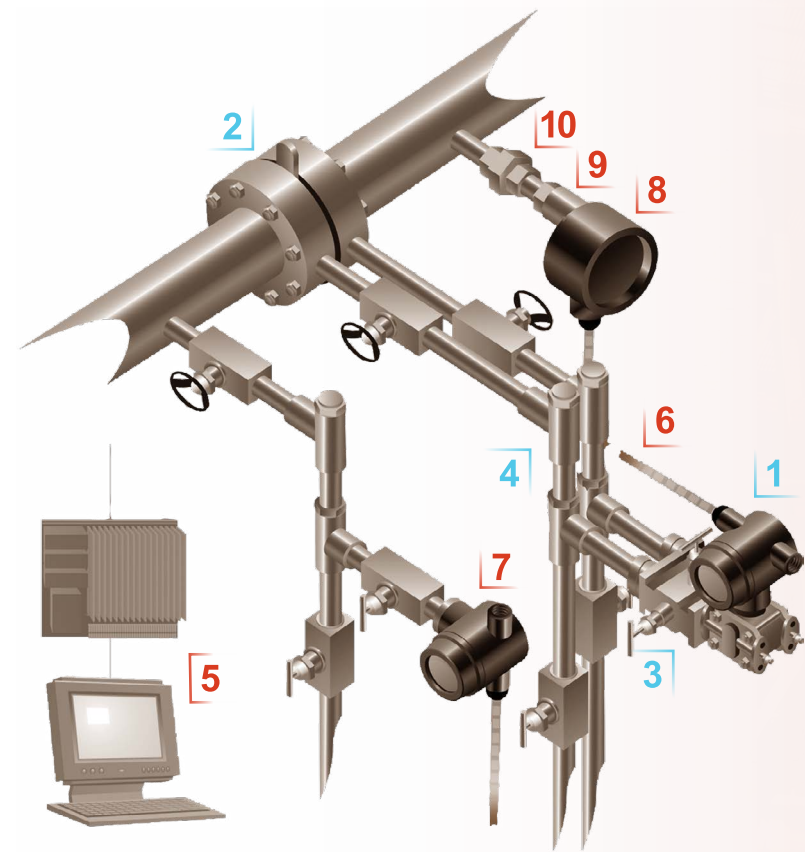

TRADITIONAL

1. DP Transmitter
2. Primary Element
3. Manifold
4. Connection Hardware

FULLY COMPENSATED

5. Flow Computer
6. Sensor Wiring
7. Pressure Transmitter
8. Temperature Transmitter
9. Thermowell
10. Temperature Sensor

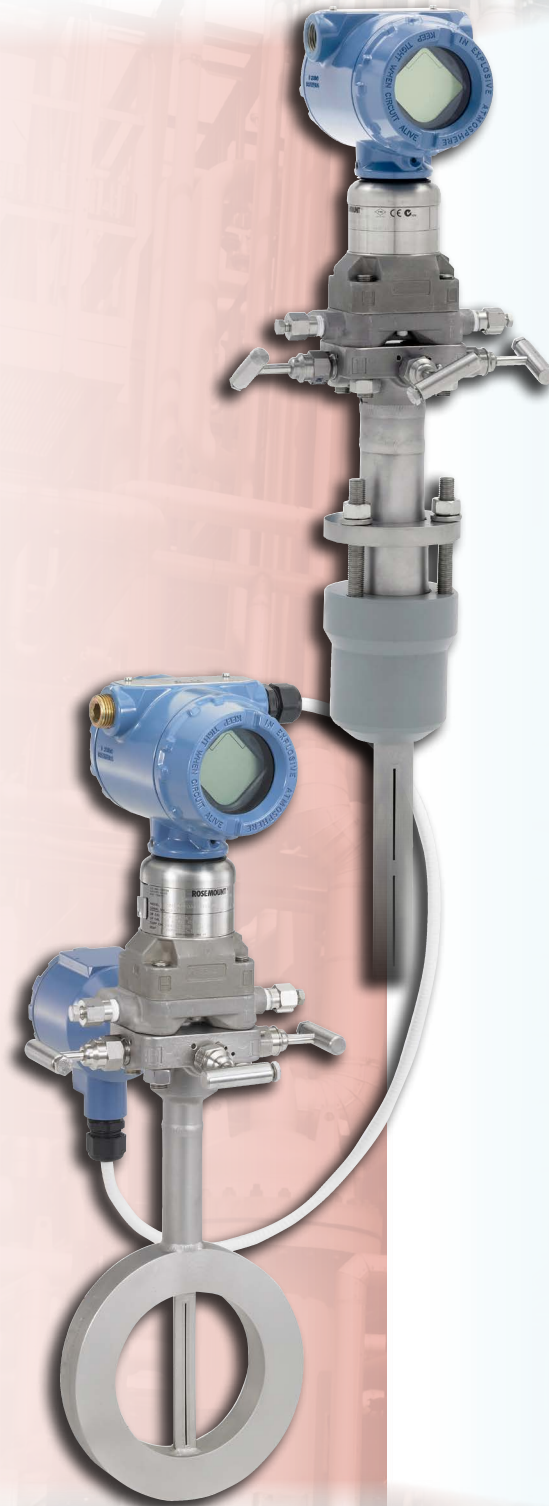

Rosemount Integrated Flow Meter Best Practice

Rosemount Annubar flow meters combine the industry's best differential pressure and multivariable transmitters with the leading averaging pitot tube technology to create the most accurate and reliable solution available.

Elimination of Impulse Lines Reduces Maintenance Costs

Impulse lines are a major source of flow measurement errors and process leaks. By eliminating impulse lines, Rosemount flow meters have 70% fewer leak points, and reduce the susceptibility of freezing and plugging.

Reduce Installation Costs

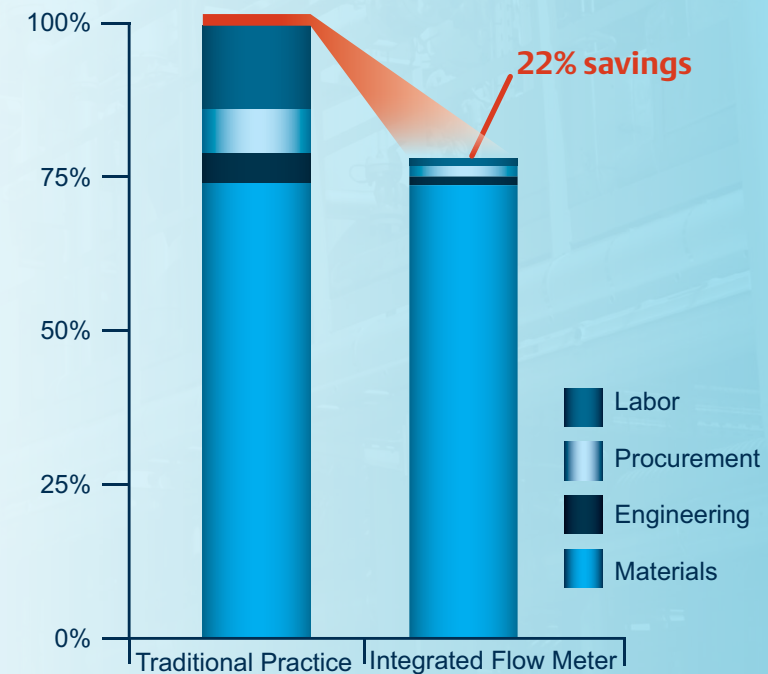

Fully Configured Flow Meters Reduce Labor Time

Rosemount Annubar flow meters arrive fully configured, leak tested, and ready to install. Configuration and calibration are completed at the factory to ensure a quick start-up.

Simplify Procurement with Rosemount Flow Meters

The ability to order a complete flow meter with a single model number simplifies the procurement process. The time and coordination of ordering components from multiple vendors for each flow measurement point is eliminated.

Flow Meter Technology, Advanced.

Rosemount Annubar flow meters are engineered with advanced capabilities to maximize your success through faster start-ups, reduced operating costs, and higher productivity.

Simplify and Improve Mass Flow Measurement

MULTIVARIABLE TECHNOLOGY

Rosemount 3051S MultiVariable™ transmitters deliver unprecedented performance and capabilities by integrating multivariable technology into the industry-leading, scalable Rosemount 3051S platform. The result is effortless flow measurement for tighter control and improved productivity.

Predict and Prevent Abnormal Flow Conditions

ADVANCED DIAGNOSTICS

Enhance quality and improve productivity with Advanced Diagnostics. Measure and log statistical process characteristics to proactively monitor, detect and alert you to abnormal flow conditions.



Extend Process Insight and Improve Operations

WIRELESS FLOW METER TECHNOLOGY

Emerson Smart Wireless flow meters offer unparalleled ease of use. Installing and commissioning a fully integrated and configured wireless Rosemount Annubar flow meter is fast and easy.



YOU ENTER

- 1 PROCESS FLUID
- 2 PRIMARY ELEMENT
- 3 LINE SIZE

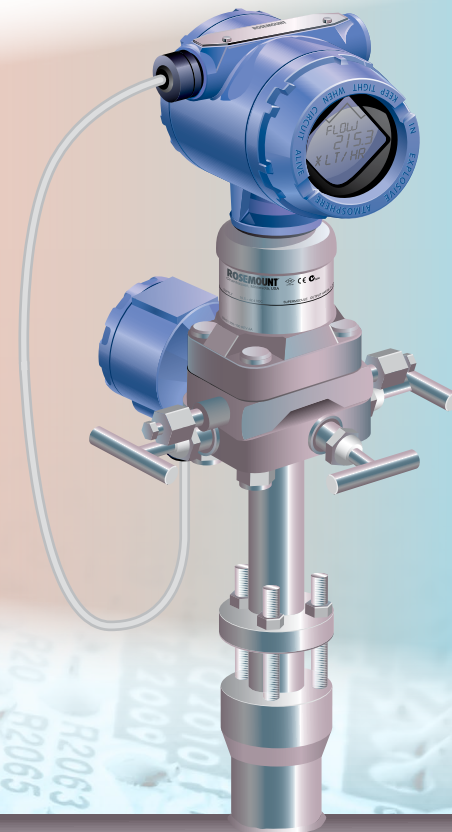

YOU RECEIVE

- MASS FLOW
- VOLUMETRIC FLOW
- TOTALIZED FLOW
- ENERGY FLOW
- PROCESS TEMPERATURE
- DIFFERENTIAL PRESSURE
- STATIC PRESSURE
- MODULE TEMPERATURE

Increase Turndown and Reduce Maintenance Costs

ULTRA FOR FLOW

Eliminate transmitter stacking and improve performance over a wider turndown with a more accurate transmitter. The Rosemount 3051S Ultra for Flow option includes industry leading 10-year stability that provides an 80% reduction in calibration requirements.

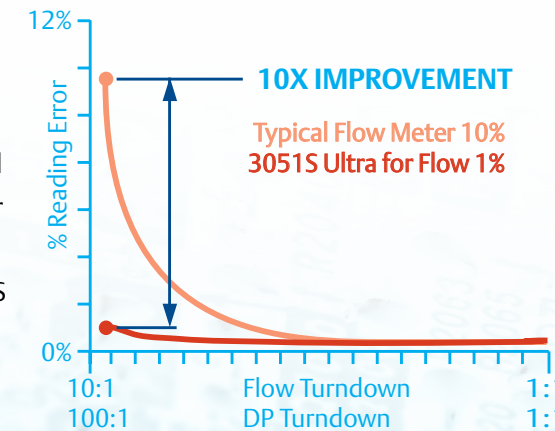

SCALABLE COMPENSATION

COMPENSATED DISCHARGE COEFFICIENT

TEMPERATURE COMPENSATED

PRESSURE COMPENSATED

FULLY COMPENSATED MASS, ENERGY, AND VOLUMETRIC FLOW

FLUID MEASURED

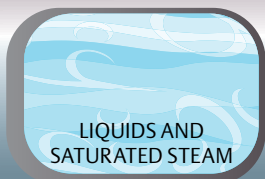
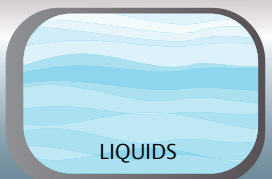

Flow Meter Offering, Unrivaled.

The Rosemount Annubar flow meter series meets the needs of diverse process applications, whether it is high accuracy for precision control or high strength for severe flow applications.

Flexible mounting styles



Pak-Lok

Utilizes the latest patented compression design to firmly secure the Rosemount Annubar sensor to the opposite wall of the pipe.

Flanged

The rugged structural requirements of high-pressure applications are met with the flanged assembly.

Flange-Lok

Combines a Pak-Lok compression sealing mechanism with a mounting flange for convenient installation with a single pipe penetration.

Compact

Easily installs between any existing raised face flange without creating additional pipe penetrations.

Flo-Tap

The Flo-Tap Rosemount Annubar assembly can be hot-tapped without interrupting process flow. There is no need to shut down your process to install a flow meter.

Severe service flow applications

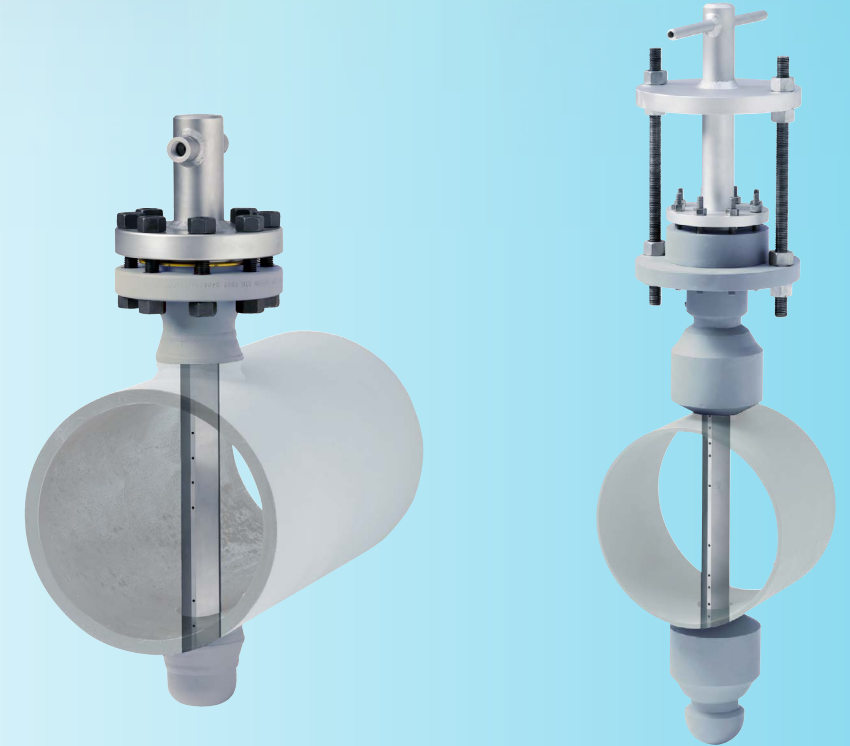

Rosemount 585 Annubar Primary Element for Severe Service

Reliable solution for severe service applications including high velocity, high temperature, high pressure, and extreme flowing conditions. Offered in a variety of materials for optimal compatibility with the process.

Rosemount 585 Annubar Primary Element for Steam

Designed exclusively for critical steam service in power plants or cogeneration systems, offering maximum resistance to the harmful effects of high temperature steam. Easy-to-maintain design allows for simple removal for steam blow and other maintenance procedures.



Rosemount World Headquarters
Emerson Automation Solutions
6021 Innovation Blvd.
Shakopee, MN 55379, USA
+1 800 999 9307 or +1 952 906 8888
+1 952 949 7001
RFQ.RMD-RCC@Emerson.com



North America Regional Office
Emerson Automation Solutions
8200 Market Blvd.
Chanhassen, MN 55317, USA
+1 800 999 9307 or +1 952 906 8888
+1 952 949 7001
RMT-NA.RCCRFQ@Emerson.com

Latin America Regional Office
Emerson Automation Solutions
1300 Concord Terrace, Suite 400
Sunrise, FL 33323, USA
+1 954 846 5030
+1 954 846 5121
RFQ.RMD-RCC@Emerson.com

Europe Regional Office
Emerson Europe GmbH
Neuhofstrasse 19a P.O. Box 1046
CH 6340 Baar
Switzerland
+41 (0) 41 768 6111
+41 (0) 41 768 6300
RFQ.RMD-RCC@Emerson.com

Asia Pacific Regional Office
Emerson Automation Solutions
1 Pandan Crescent
Singapore 128461
+65 6777 8211
+65 6777 0947
Enquiries@AP.Emerson.com

Middle East and Africa Regional Office
Emerson Automation Solutions
Emerson FZE P.O. Box 17033,
Jebel Ali Free Zone - South 2
Dubai, United Arab Emirates
+971 4 8118100
+971 4 8865465
RFQ.RMTMEA@Emerson.com

-  [Emerson.com/Rosemount](https://www.emerson.com/Rosemount)
-  [Facebook.com/Rosemount](https://www.facebook.com/Rosemount)
-  [LinkedIn.com/company/Emerson-Automation-Solutions](https://www.linkedin.com/company/Emerson-Automation-Solutions)
-  [Twitter.com/Rosemount_News](https://twitter.com/Rosemount_News)
-  [Youtube.com/user/RosemountMeasurement](https://www.youtube.com/user/RosemountMeasurement)
-  [Google.com/+RosemountMeasurement](https://plus.google.com/+RosemountMeasurement)

The Emerson logo is a trademark and service mark of Emerson Electric Co.
Rosemount and the Rosemount logotype are registered trademarks of Emerson.
All other marks are the property of their respective owners. © 2019 Emerson. All rights reserved.

00803-0100-6113 Rev DA July 2019



CONSIDER IT SOLVED™