

Rosemount™ Ultrasonic 3810 Series Electronics

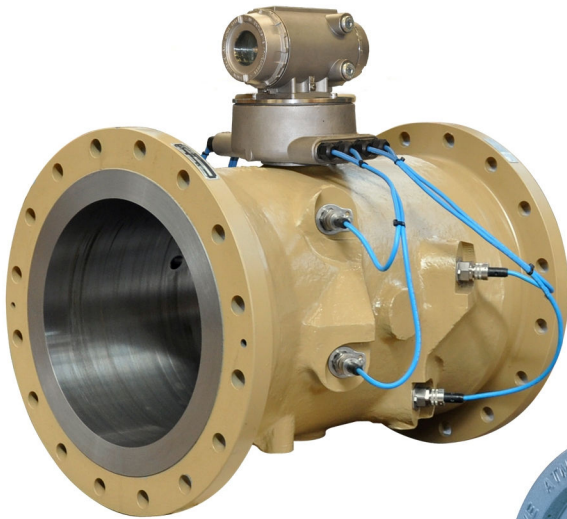

Signal words and symbols

Pay special attention to the following signal words, safety alert symbols, and statements:

Safety alert symbol

This is a safety alert symbol. It is used to alert you to potential physical injury hazards. Obey all safety messages that follow this symbol to avoid possible injury or death.

DANGER

Danger indicates a hazardous situation which, if not avoided, will result in death or serious injury.

WARNING

Warning indicates a hazardous situation which, if not avoided, could result in death or serious injury.

CAUTION

Caution indicates a hazardous situation which, if not avoided, could result in minor or moderate injury.

NOTICE

Notice is used to address safety messages or practices not related to personal injury.

Important

Important is a statement the user needs to know and consider.

Tip

Tip provides information or suggestions for improved efficiency or best results.

Note

Note is “general by-the-way” content not essential to the main flow of information.

Contents

Chapter 1	Plan.....	5
	1.1 Introduction.....	5
	1.2 Before you begin.....	5
	1.3 Before removing the 3800 Series Electronics.....	6
	1.4 Removing 3800 Series Electronics.....	12
Chapter 2	Install.....	15
	2.1 Installing the 3810 Series Electronics.....	15
Chapter 3	Operate.....	29
	3.1 Configure the 3810 Series Electronics.....	29
Appendix A	Mark III Wiring I/O and switch settings.....	43
	A.1 3800 Series RS-232 Full Duplex.....	45
	A.2 3800 Series RS-485 Half Duplex.....	45
	A.3 3800 Series Discrete output switch settings.....	46
	A.4 3800 Series RS-232 Full Duplex.....	47
	A.5 3800 Series RS-485 Half Duplex.....	48
	A.6 3800 Series Series 100 option board (if installed).....	48
	A.7 3800 Series RS-232 Full Duplex.....	49
	A.8 3800 Series RS-485 Half Duplex.....	50
	A.9 3800 Series Series 100 plus HART option board (if installed).....	50
Appendix B	Summary table of communications/output settings.....	53
Appendix C	3810 Communication and Output settings.....	57
	C.1 3810 Wiring and I/O	57
	C.2 Ethernet cable to PC communication.....	59
	C.3 Input and output connections.....	60
	C.4 Serial communications.....	64
	C.5 Analog input settings.....	66
	C.6 Analog output settings.....	66
	C.7 Digital Input.....	66
	C.8 External power source connection and fuse.....	66
Appendix D	3810 Series engineering drawings.....	69

1 Plan

1.1 Introduction

1.1.1 General

Welcome to the Rosemount 3810 Series Ultrasonic Instruction Manual.

This manual has been designed to provide you with a step-by-step set of instructions for a Rosemount Liquid Ultrasonic meter with 3800 Series electronics to the new 3810 Series electronics.

NOTICE

Please read the "Before You Begin" section to make sure you have all the components necessary to perform the before taking the meter out of service.

1.2 Before you begin

This section shows all of the parts and tools required to perform the upgrade. Ensure that all of these items are available before taking the 3800 Series meter out of service.

1.2.1 Required parts

Ensure that you have received the to upgrade your meter.

1.2.2 Tools required

Figure 1-1: Required Tools

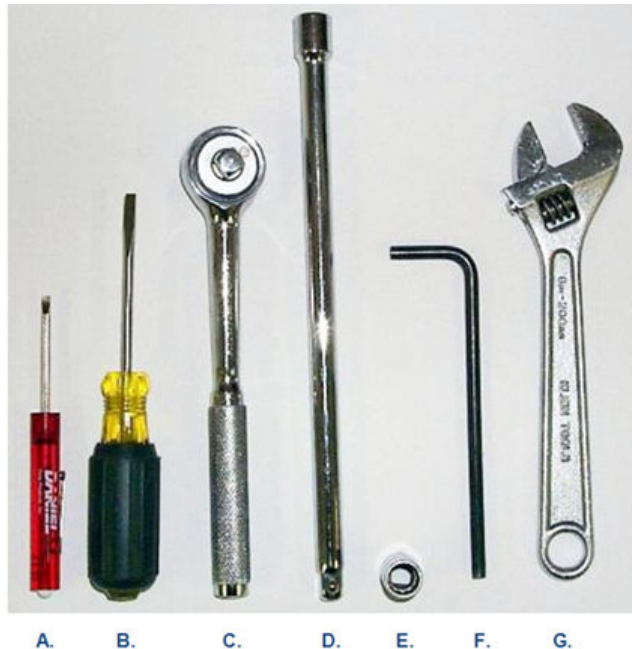

- A. *1/8-in. flat-blade screw driver*
- B. *1/4-in. flat-blade screw driver*
- C. *3/8-in. drive ratchet wrench*
- D. *3/8-in. drive - extension - at least 3.5-in. long*
- E. *3/8-in. drive - 7/16-in. socket*
- F. *Allen wrench - size 6 mm*
- G. *Crescent wrench for cable glands and electrical conduit*

MeterLink™ is required to communicate with the meter electronics, access information and collect the configuration in the meter and then convert and download the configuration into the new 3810 Series electronics. Always use the latest version of MeterLink™. Upgrades to the latest version are available at: www.emerson.com.

1.3 Before removing the 3800 Series Electronics

1.3.1 Procedure before removing the 3800 Series Electronics

Procedure

1. Before removing power from the meter being software to connect to the meter.
2. Use the `Edit/Compare Configuration` screen in MeterLink™ to read the configuration from the meter and save it to a file on your computer. An example for a file name might be "Meter Name, 3800 Series Final Config, 3-4-2013 10-15-02 AM.cfg". MeterLink will be used later in this procedure (see [Configure the 3810 Series Electronics](#)) to convert the configuration and download it to the 3810 Series electronics.

⚠ CAUTION

Loss of set-up data

The current meter configuration file must be saved before beginning the 3810 Series electronics .

Failure to save the current configuration file can result in the loss of important set-up data.

Steps 3 through 8 provide more detailed instructions on obtaining the required information with respect to the communications set-up of the 3800 Series electronics, however, if these settings are already known, these steps can be skipped. Step 8 is for Frequency and Diagnostic outputs. For reference, the known values should be entered in the [Summary table of communications/output settings](#). This information will be required in the setup of the 3810 Series electronics. For any setting which is not known, the applicable step(s) for obtaining that information can be used.

3. Use the File|Meter Directory menu path, then select the <<meter name>> you want to .
 - a) Click the **Direct** button on the lower left corner of the Meter Directory dialog box.
 - b) The **Direct Connection Properties For** dialog appears.
 - c) Obtain the Modbus ID (same as Comms Address).

Figure 1-2: Accessing Modbus ID for Ports A and B

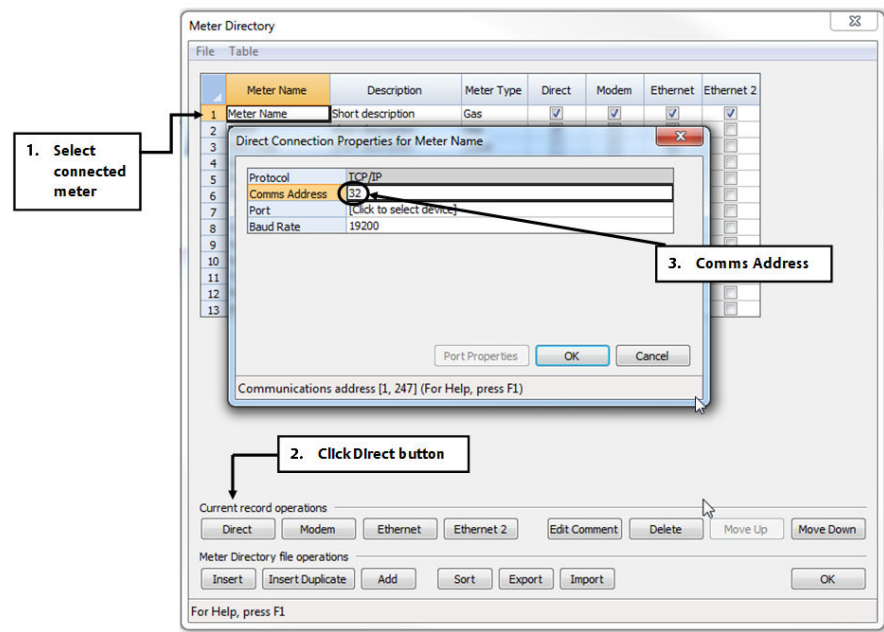

4. Based on the information contained in the connection properties window, enter the values for the following parameters in the [Summary table of communications/output settings](#):

Port A and B: Modbus ID = ____ (enter Comms Address).

5. Exit MeterLink and disconnect your PC from the meter electronics. The remaining information required before doing the , is based on the wiring terminations and the settings of various switches on the boards that comprise the electronics.
6. Power down the electronics.

⚠ CAUTION

Equipment damage

Remove power from the meter electronics.

Failure to remove power from the meter electronics may result in damage to the equipment.

7. Remove the end caps from the upper electronics housing of the meter to access the electronic circuit boards. See [Figure 1-4](#) for board layout of the 3800 Series stacks. See [Figure 2-14](#) for the 3810 Series electronics for board layout.

Figure 1-3: Remove End Caps from the Upper Electronics Enclosure

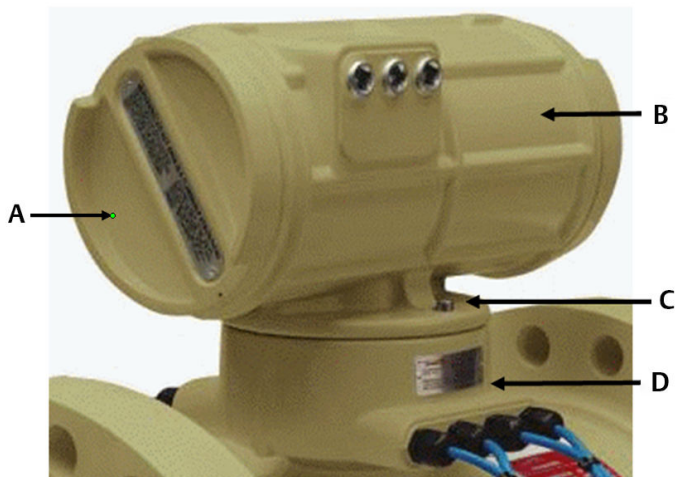

- A. End cap
- B. Upper enclosure
- C. Enclosure bolts
- D. Base enclosure

Figure 1-4: 3800 Series Electronics Assembly board layout

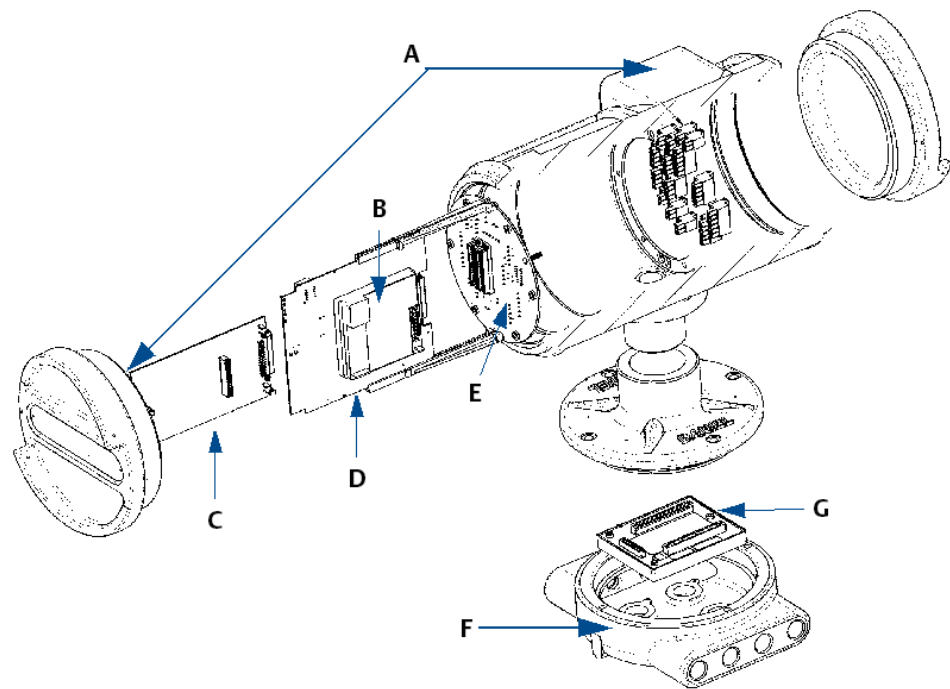

- A. Upper explosion- proof Mark III housing assembly
- B. I.S. interface board
- C. Option boards
- D. CPU board assembly
- E. Field termination board
- F. Base unit Mark III Electronics
- G. Acquisition board

8. Remove the 3800 Series electronics CPU board, the HART Option Board, and the Field Termination Board from the enclosure. Fill out the [Summary table of communications/output settings](#) based on the Field Connection Board wire terminations and/or switch settings of the CPU board and Option Board, if installed. This information will be used to configure the new 3810 Series electronics later in this procedure.

Figure 1-5: 3800 Series CPU Board Showing Switch Settings

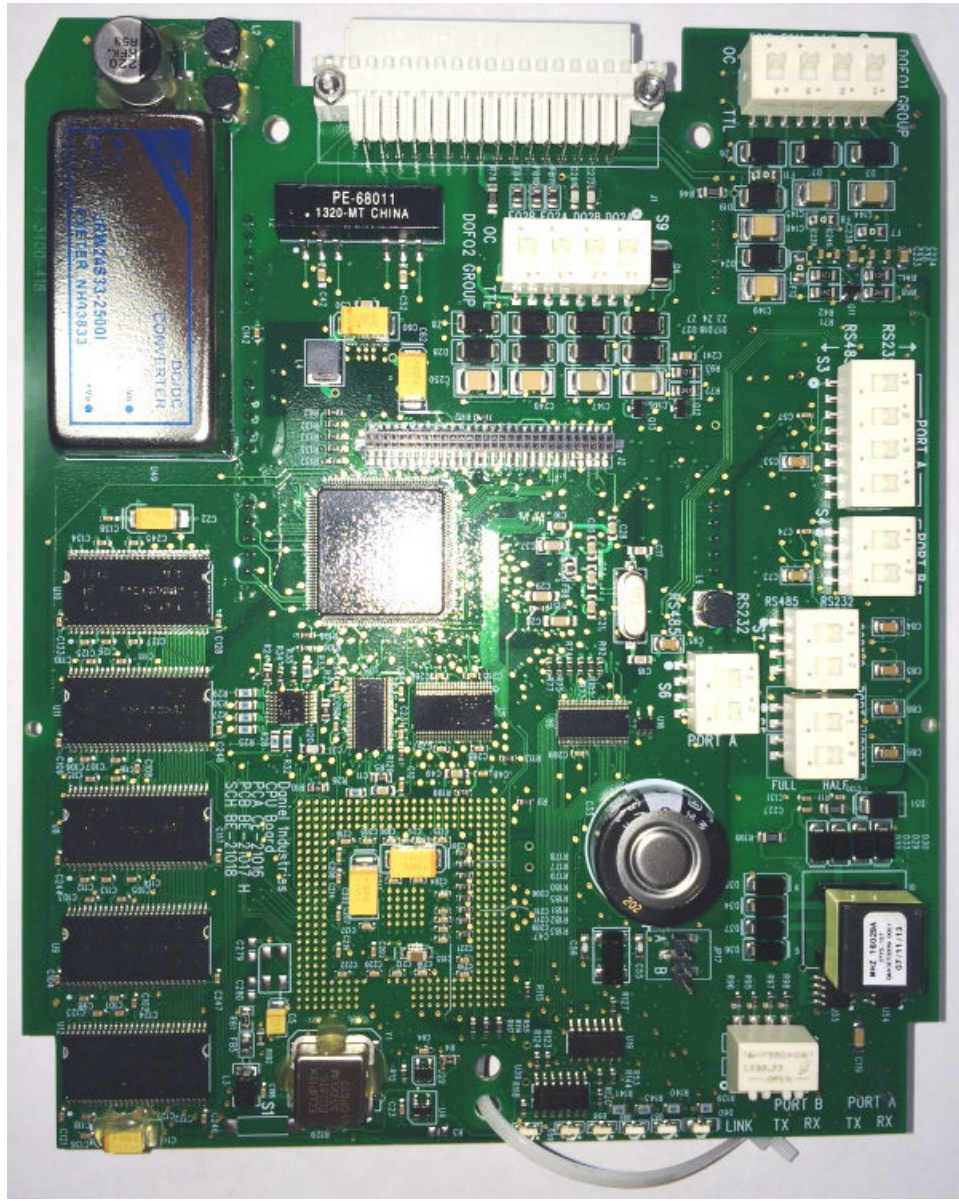

Figure 1-6: 3800 Series CPU Board with I.S. Barrier Board Piggy-Backed on CPU Board



1.4 Removing 3800 Series Electronics

1.4.1 Procedure to remove the 3800 Series Electronics

Procedure

1. Having obtained all the information related to the set-up of the 3800 Series electronics configuration and communications, all the components related to the electronics can now be physically removed from the meter. Unscrew all wiring from the Field Termination Board. It may be helpful to label the wires to make it easier to connect the 3810 Series electronics.
2. Remove any conduit and wiring attached to all six conduit ports.
3. Remove any ground wire attached to the ground lug on the outside of the upper electronics housing. At this point there should be no wires connected to the upper electronics housing.

Figure 1-7: Ground Wire Removed



4. Use the 6 mm Allen wrench (supplied with kit) to remove the two bolts holding the base enclosure.

Figure 1-8: Remove Bolts from Base Enclosure Cover



5. Remove the upper electronics housing from the base enclosure.
 - a) Remove the Acquisition cable, which comes down from the upper electronics to the Acquisition module in the base enclosure.

NOTICE

Figure 1-9 shows the Acquisition module for the 3400 Series electronics.

- b) Loosen the two screws on the ends of the Acquisition cable connector, and disconnect it from the Acquisition module.
- c) Set the upper electronics housing aside once the housing is removed.

Figure 1-9: Remove the Acquisition Cable

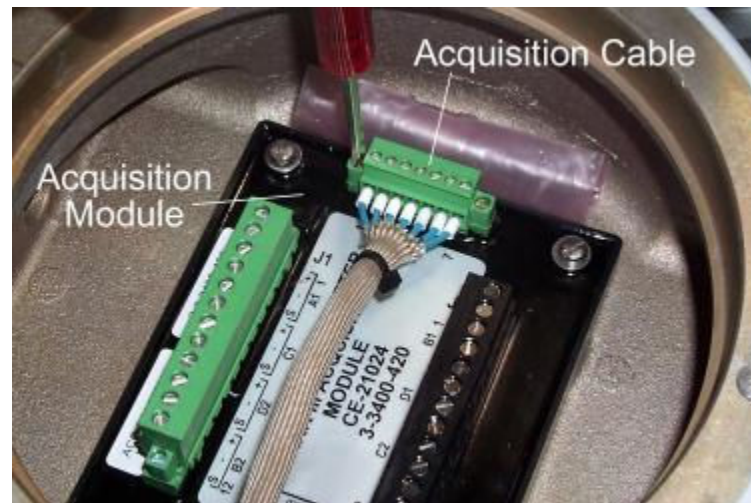

6. Remove all the screws that hold the transducer wires in the terminal blocks that attach the transducers to the Acquisition module.
 - a) Remove the screws from the ends of the two connectors.

- b) Disconnect the connectors and remove each of the transducer wires from the connector.
7. Loosen the cable glands on the base enclosure and pull all of the transducer cables out of the base enclosure.
8. Unscrew the three screws holding the Acquisition module in the base enclosure and remove the Acquisition module.
The four mounting bolts holding the enclosure cover to the meter body are sealed with an RTV silicone adhesive/sealant.
9. Remove the RTV with a flat blade screwdriver or utility knife around the perimeter of the recessed opening and the RTV eases the removal of the sealant.
 - a) Use the 7/16-in. socket wrench to remove the four mounting bolts.

Figure 1-10: Remove Old RTV



10. Remove the base enclosure from the meter body.
11. If RTV silicone adhesive/sealant was used to seal the base enclosure to the meter body, remove the adhesive/sealant so the 3810 base enclosure will have a clean mounting surface.
The 3800 Series electronics should be completely removed from the meter body at this time.

2 Install

2.1 Installing the 3810 Series Electronics

2.1.1 Procedure to install the 3810 Series Electronics

Procedure

1. Remove the 3810 Upgrade components from the packaging.
 - a) Use the 6 mm Allen wrench to remove the two screws from the base enclosure cover.
2. Lift the upper electronics housing from the base enclosure. The acquisition cable connector from the upper electronics is attached to the acquisition module with two screws. The cable is also secured by a cable clamp to a mounting bolt.
 - a) Remove the screw securing the cable clamp and then loosen the two screws on the acquisition cable connector and disconnect the acquisition cable connector from the acquisition module.

Figure 2-1: Remove Acquisition Cable and Module

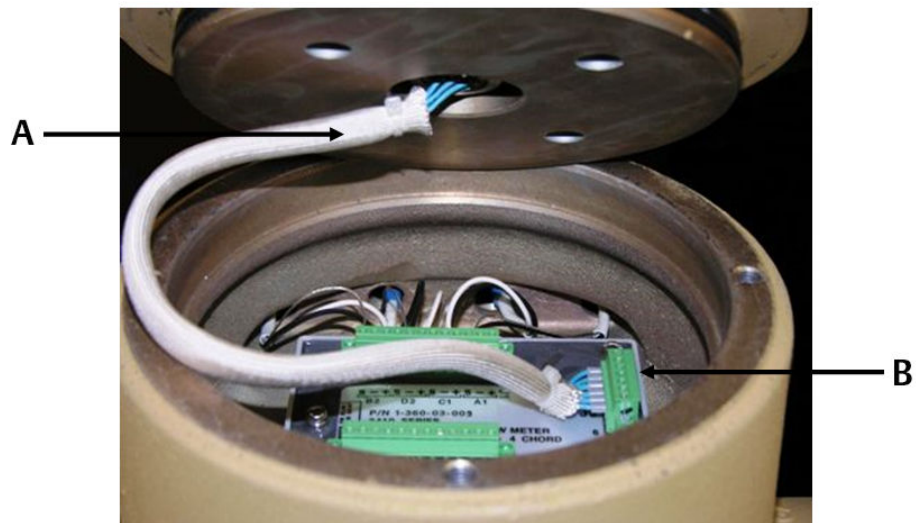

- A. Acquisition cable
- B. Acquisition cable connector

3. Unscrew the remaining two mounting screws from the acquisition module in the base enclosure and remove the acquisition board.
4. Place an insulating gasket on the meter body where the electronics will be mounted (see gasket in [Figure 2-14](#)).
5. Place the base enclosure on top of the meter body on top of the insulating gasket. Note that the transducer port openings on the base enclosure are labeled with transducer locations (i.e., A1, A2, B1, B2, C1, C2, D1, D2).
 - a) Orient the base so that the A1 transducer port is closest to the A1 transducer location on the meter body. The meter body has the transducer location

labels embossed in the body next to each transducer boss. The ports on the base enclosure must be oriented outward (towards the sides of the meter body, perpendicular to meter axis).

Figure 2-2: Base Enclosure Orientation

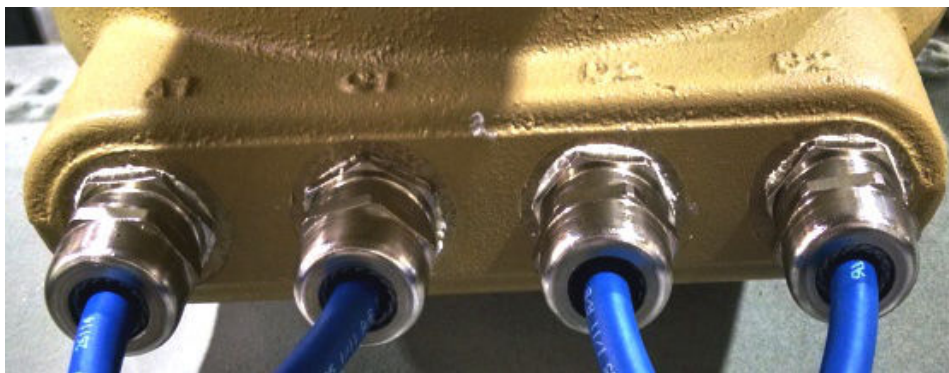

6. Use the four ¼-in. bolts with stainless steel washers and nylon shoulder washers to secure the base enclosure to the meter body.
 - a) Use a nut driver to tighten the bolts to a torque of 55 to 65 inch-lbs.

Figure 2-3: Insert ¼-in. Bolts



7. Fill up the base enclosure wells with RTV adhesive/sealant around and over the four ¼-in. bolts.

This will ensure a water-tight seal. Any excess sealant can be removed by using a scraper to leave the sealant flush with the top of the well. Excess sealant will adhere to the acquisition board when it is installed, and make future removal of the board difficult.

Figure 2-4: Apply RTV Sealant Around Bolts



8. Insert the Acquisition board in the base enclosure and secure it with the two screws as shown for now.

Figure 2-5: Acquisition Module Attachment Screws

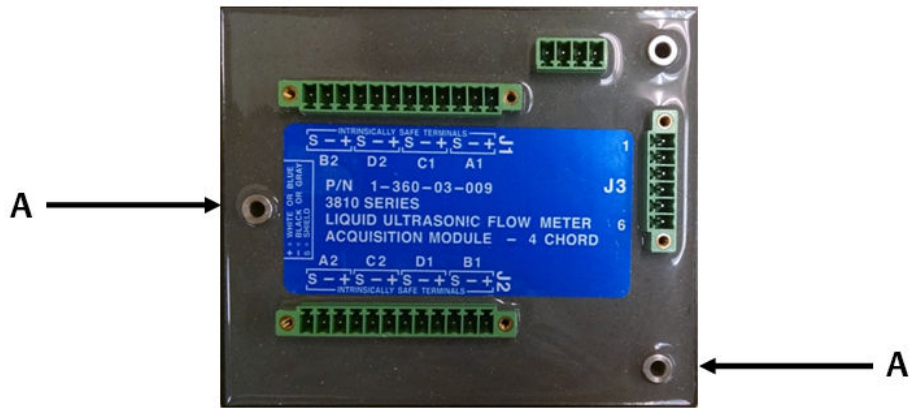

A. Acquisition Module screw

Figure 2-6: Acquisition Module Wiring

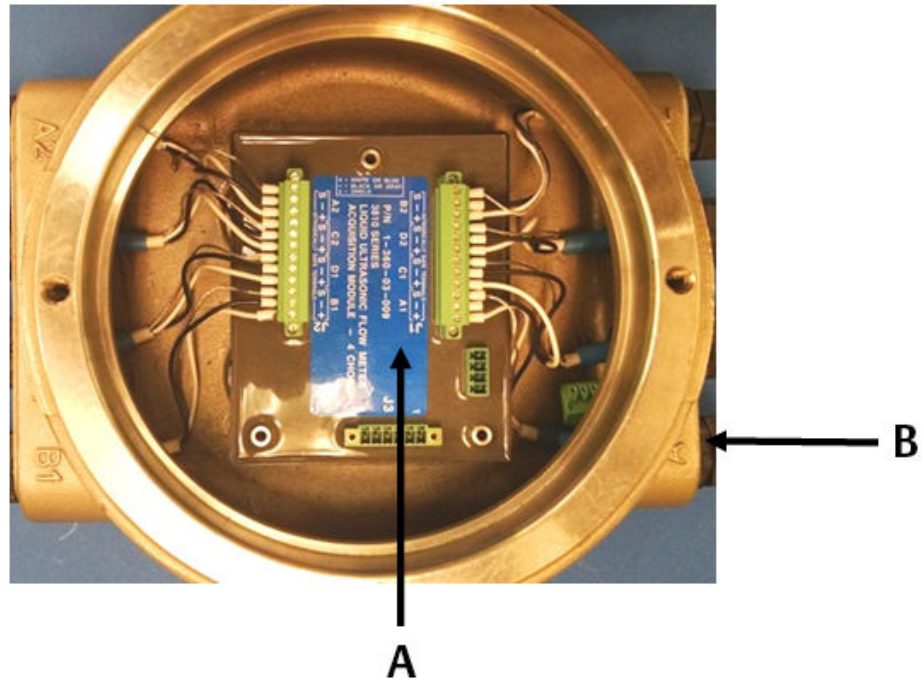

- A. Acquisition Module A1 transducer wiring*
- B. Base enclosure A1 transducer port*

9. Route the transducer cables through the cable glands with the correct label number (i.e. A1) which matches the label on the transducer cable.

Figure 2-7: Base Enclosure Cable Glands Installation

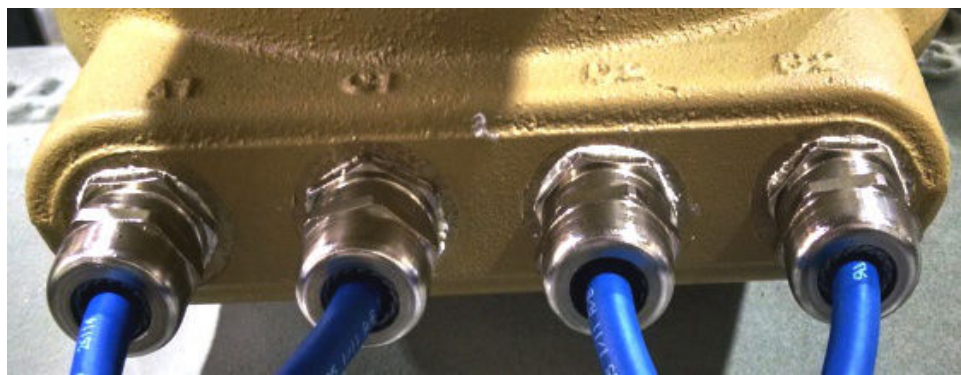

10. Judge the proper length and cut off the excess.
11. Strip the outer insulation, outer shield, and inner insulation using a utility knife. Verify that insulation of individual wires was not cut while removing outer layers. Strip each wire 0.28-in.

Figure 2-8: Transducer Cable Cut Instructions

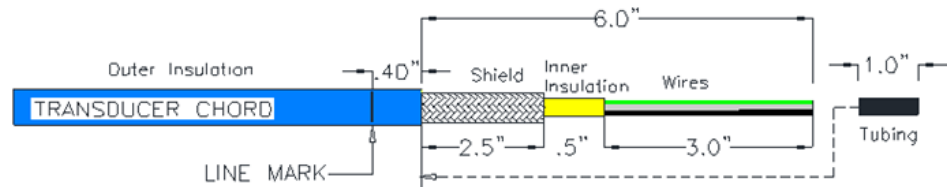

12. Insert tubing over wires, inner insulation and under shield approximately 1.5-in. of shield should overlap.
13. Insert and secure transducer cables through cable glands verify Line Mark is as referenced in [Figure 2-7](#).

Figure 2-9: Line Mark

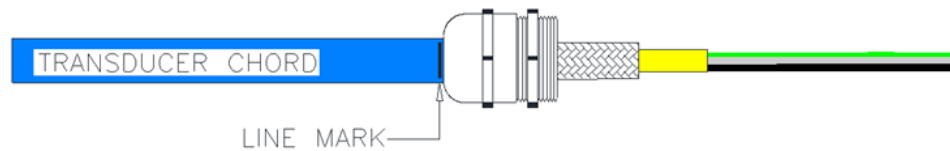

14. Using a torque screwdriver set to 78 ± 7 oz.-in. secure the wires to the terminal plugs of the Acquisition Module.
15. Verify the cable lengths are still an appropriate length and if necessary, cut the transducer cables to the correct length with allowance for the wiring terminations and connector placement.
16. Ensure that the contacts clamp on the bare wires and not on the wire insulation when the wires are being terminated on the connector.
 - a) Leave the connector plugged into the Acquisition board while terminating the individual wires.
 - b) Tighten the connector screws on the either end of the connector after terminating all the wires on the applicable connector.
 - c) Repeat this procedure for the transducer cables on the other side of the meter.

Figure 2-10: Install Cable and Secure Wires

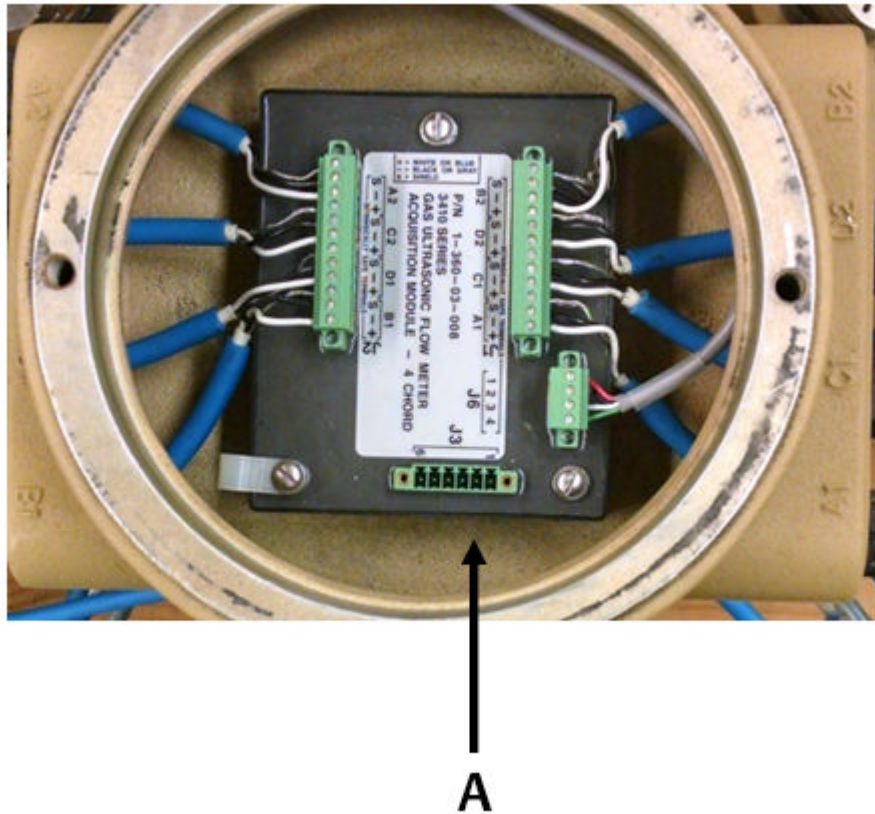

A. Acquisition Module transducer wiring

17. Use the cable ties to dress the transducer cables. They should be dressed in groups of two: A1 and C1, D1 and B1, A2 and C2, D2 and B2. Install one cable tie at three inches from the base enclosure and another about the point where the cables start to bend and separate out to their respective port.

Figure 2-11: Re-oriented and Secured Transducer Cables

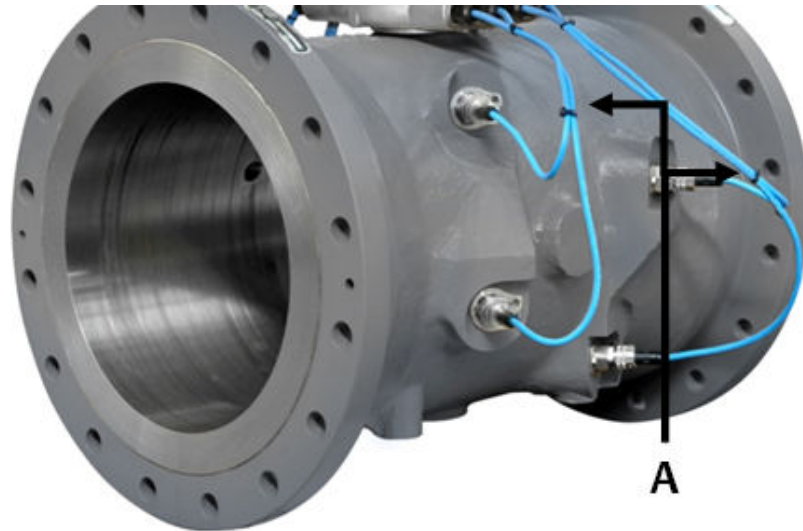

A. Transducer cable ties

18. Reconnect the acquisition cable connector to the acquisition module and secure the cable connector by tightening the two screws.
19. Install the cable clamp on the Acquisition cable with the screw, lock washer, flat washer to secure the cable to the final mounting hole of the Acquisition module.

Figure 2-12: Installing the Acquisition Cable and Module

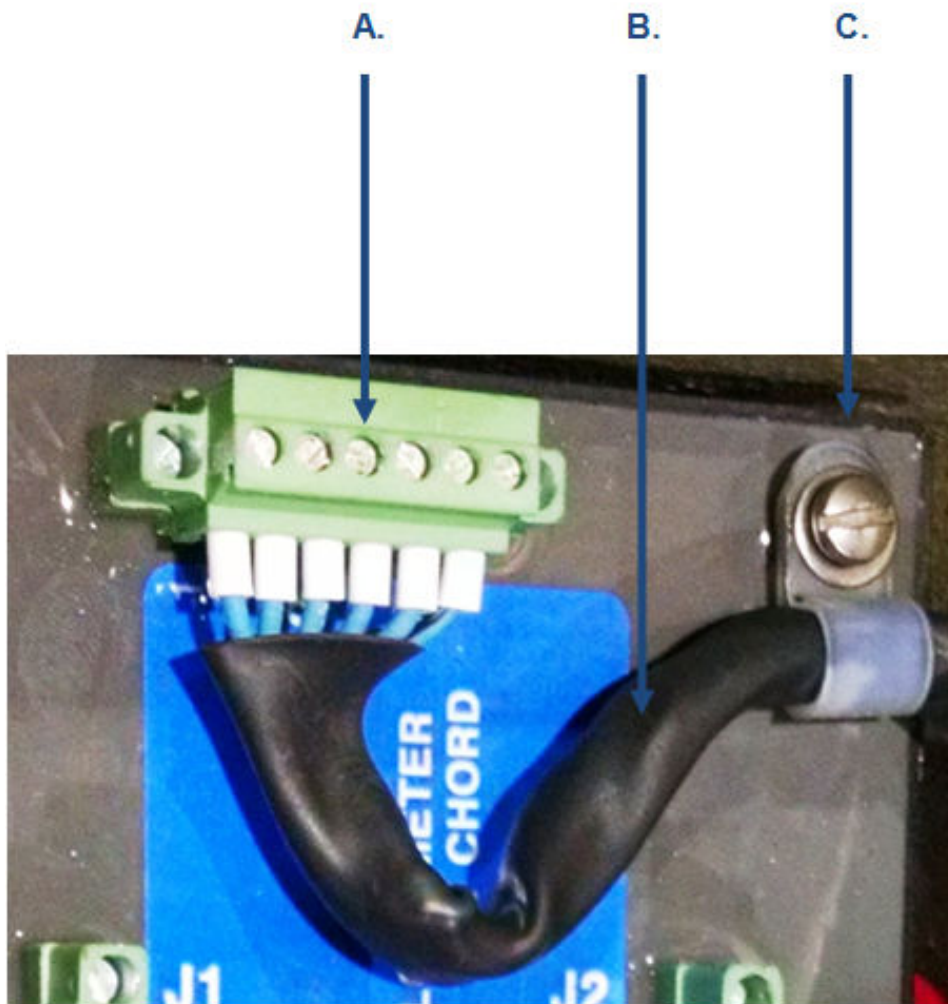

- A. Acquisition cable connector
- B. Acquisition cable
- C. Cable clamp and screw

20. Wrap the excess cable around the Acquisition Module and place the electronics housing into position on the base enclosure.
21. Ensure the O-ring on the base of the upper enclosure is properly seated. Position the upper enclosure housing so that it is in the desired orientation for reattaching the electrical conduit.
22. Install the 3810 meter upper enclosure on the base enclosure once the transducers are wired correctly.
23. Install the two screws with the 6 mm Allen wrench to secure the upper enclosure to the base enclosure.

Figure 2-13: Bolt the Upper Enclosure to Base Enclosure

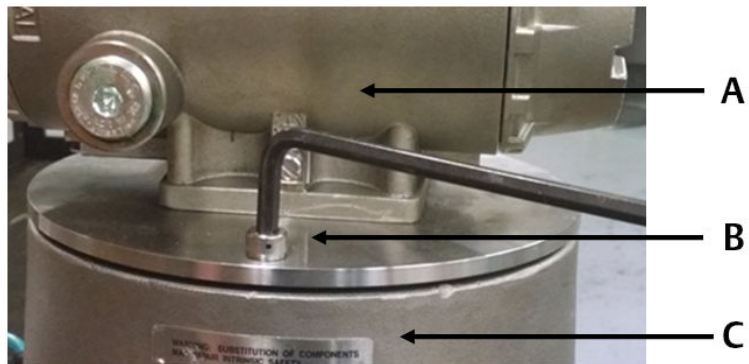

- A. Upper enclosure
- B. Enclosure bolts
- C. Base enclosure

24. Remove the end cap next to the conduit entries from the upper enclosure. [Figure 2-14](#) shows the layout of the 3810 electronics.

Figure 2-14: 3810 Series Electronics Layout

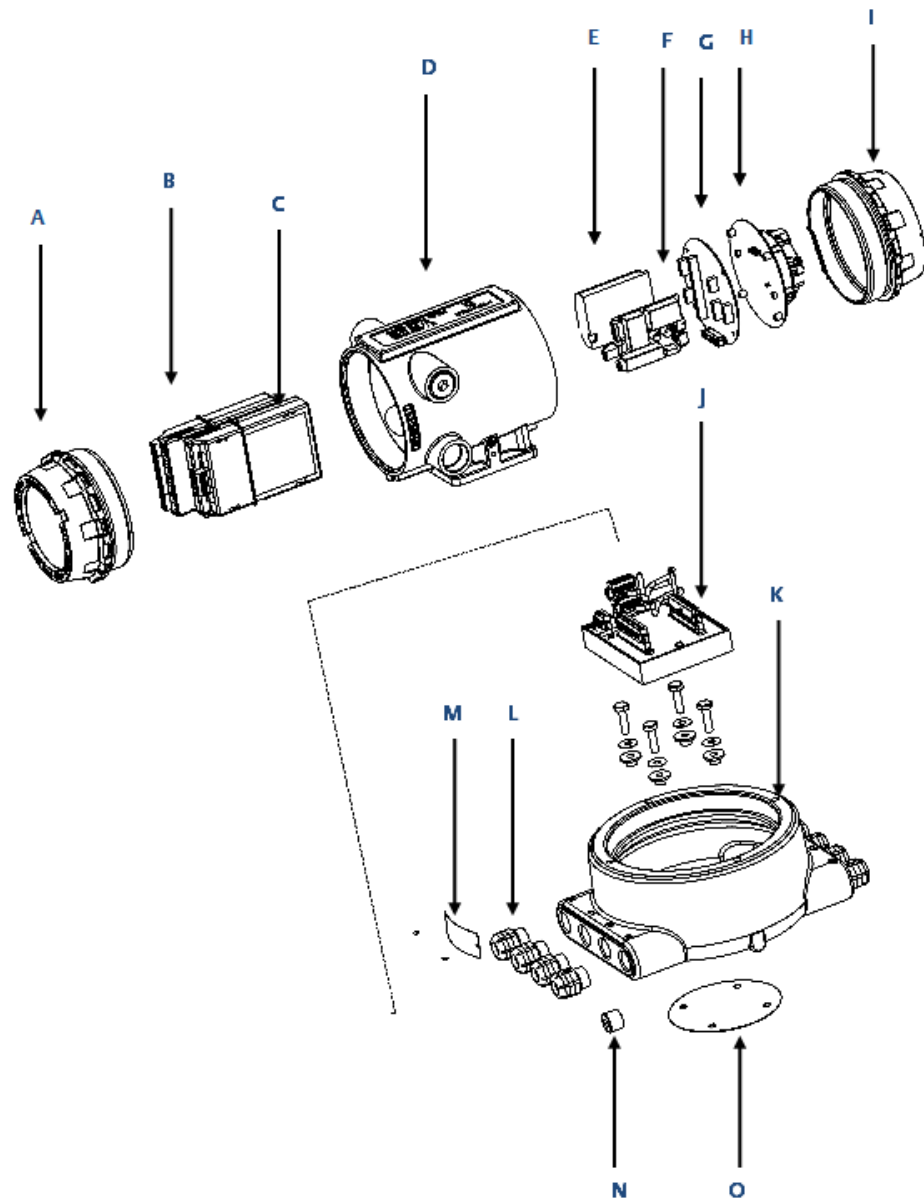

- A. End cap
- B. CPU module
- C. Optional I/O module
- D. 3810 Series Transmitter electronics enclosure
- E. I. S. Barrier module
- F. Power supply
- G. Backplane
- H. Optional local display module
- I. End cap
- J. Acquisition module

- K. Base electronics enclosure
- L. Cable glands
- M. U.L. warning tag - Base enclosure
- N. M20 plug
- O. Gasket

The following table shows the default communications and output settings for the 3810 electronics and configuration.

Table 2-1: 3810 Series Default Communications and Output Settings

Communication/output type	Default setting	Default setting	Note
Serial port A	Modbus ID = 32	Baud rate = 19200	Port B and port C are available if optional RS-232 and RS-485 I/O modules are installed.
Frequency/digital output 1	Configured to output frequency 1A	Drive mode = open collector	Frequency output 1A is configured for uncorrected forward flow.
Frequency/digital output 2	Configured to output frequency 2A	Drive mode = open collector	Frequency output 2A is configured for uncorrected forward flow.
Frequency/digital output 3	Configured to output digital output 1A	Drive mode = open collector	Digital output 1A is configured for validity status.

If the settings above are not consistent with those used in your meter, then these parameters can be changed using MeterLink™ software to reconfigure the communication ports and output ports later in this procedure. [3810 Communication and Output settings](#) of this document contains additional details with respect to the wiring related to the communications and discrete output signals.

Notice

MeterLink™ cannot communicate with 3810 meters over a half-duplex serial connection. As a result, for MeterLink to communicate via a serial connection, that port on the 3810 electronics must be set for RS-232-Full Duplex, or RS-485-Full Duplex (requires 4 conductor cables).

25. Check the CPU module switches on the to ensure they are set properly.

Figure 2-15: CPU Switch Settings

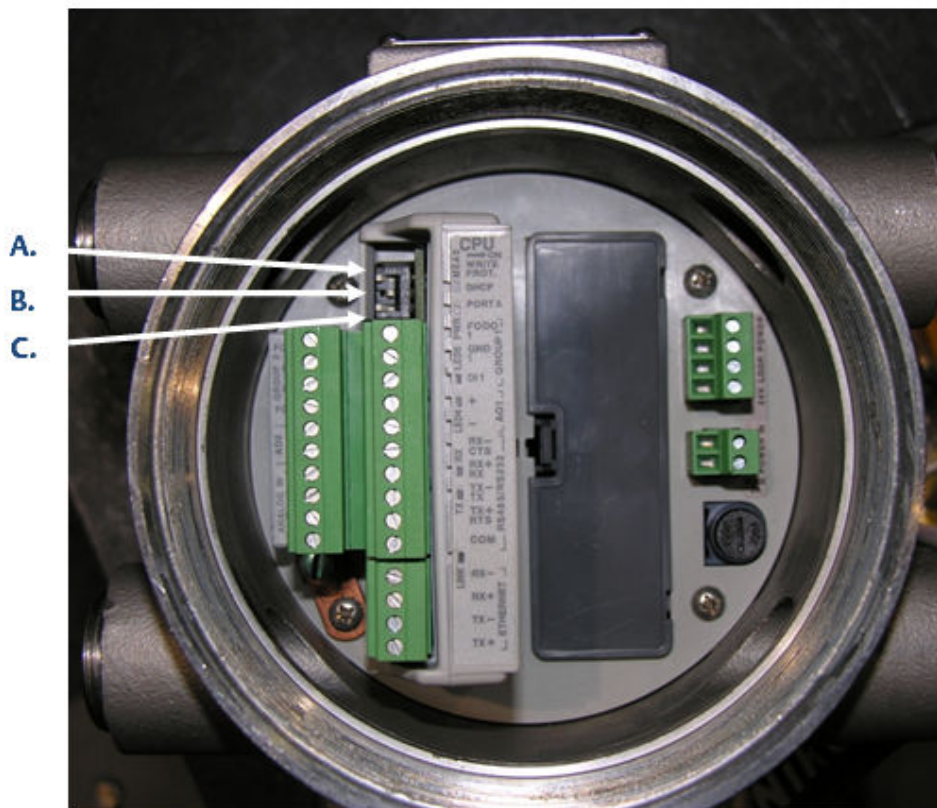

- A. *WRITE PROT. switch*
- B. *DHCP switch*
- C. *Port A (override)*

The DHCP switch enables or disables the DHCP server for Ethernet communication. The WRITE PROT. switch enables or disables “write protection” of the meter configuration.

Set the DHCP switch to the **ON** position to enable Ethernet communication via the DHCP server. Set the WRITE PROT. switch to the **OFF** position to allow configuration parameters to be written to the meter. Only enable the DHCP server if the meter is not connected to a network that may have a DHCP server already running. The DHCP server is designed for use when a PC connects directly to the meter and requires the meter to assign the PC an IP address.

26. Wire all of the electrical connections.

Figure 2-16: Install Wiring Terminal Block Connectors to the CPU Module

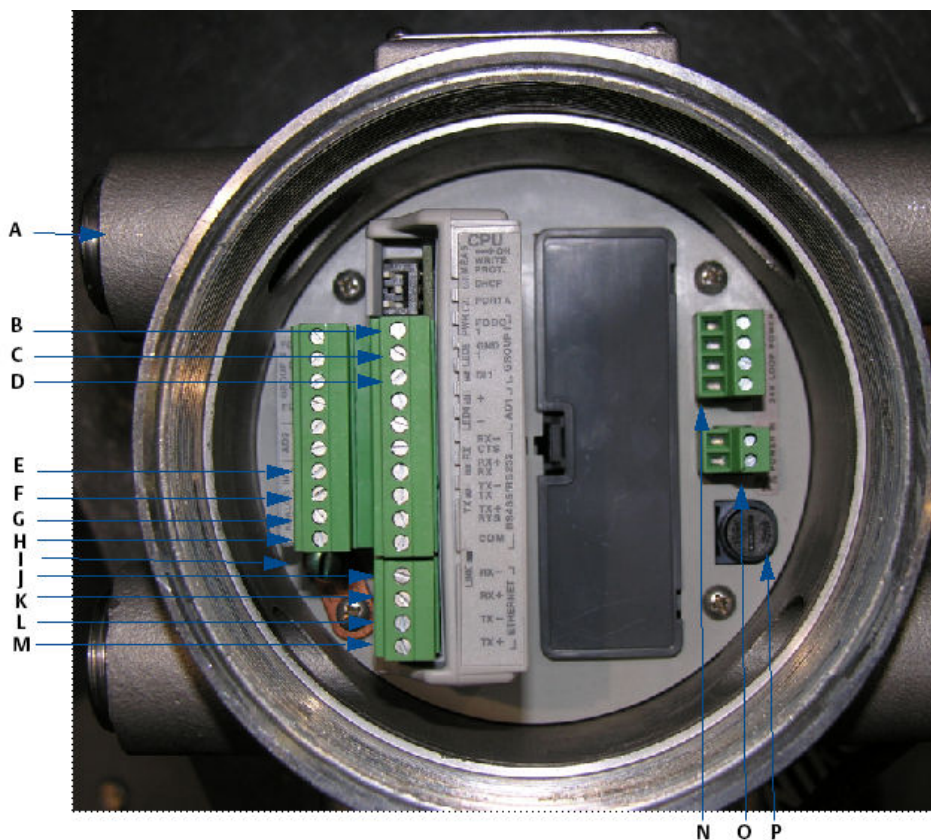

- A. Conduit wiring entry (four entries)
- B. Pulse out
- C. Ground/Prover switch -
- D. Prover switch +
- E. Temperature transmitter +
- F. Temperature transmitter -
- G. Pressure transmitter +
- H. Pressure transmitter -
- I. Internal ground lug
- J. Ethernet (orange and white wire)
- K. Ethernet (orange wire)
- L. Ethernet (green and white wire)
- M. Ethernet (green wire)
- N. 24 VDC loop power
- O. 10.4 - 36 VDC power
- P. Fuse holder

All of the terminations in the 3810 Series electronics are removable terminal blocks. Removing the terminal blocks from the modules before terminating wires to them makes wiring easier. [3810 Communication and Output settings](#) of this document also includes wiring tables and illustrations for each of the connectors

in the electronics. Refer to the System Wiring Drawing in [3810 Series engineering drawings](#).

27. Install a ground wire to the ground lug on the side of the upper enclosure.

Figure 2-17: Transmitter Electronics Enclosure Ground Wire

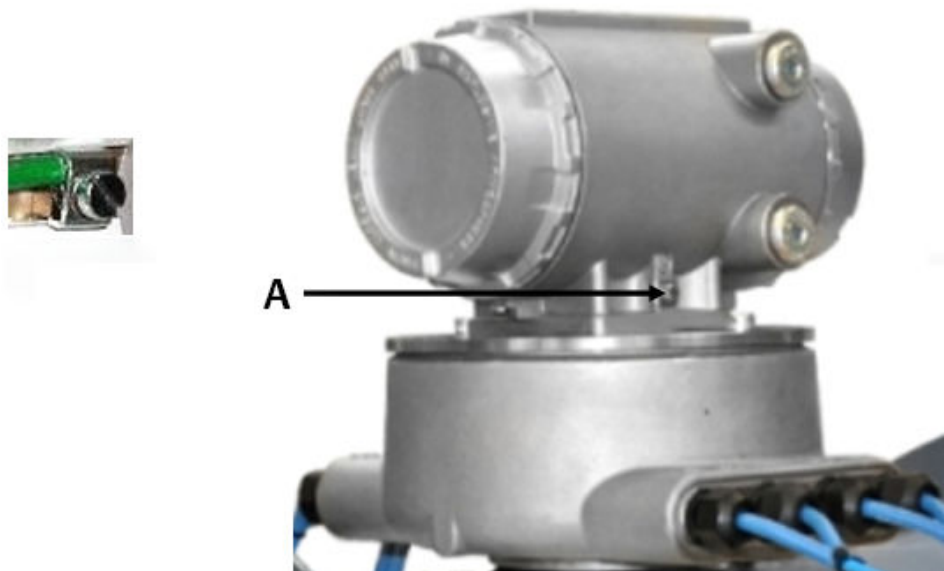

A. Attach ground wire to external ground lug

28. Attach flex conduit to the conduit ports on the transmitter electronics enclosure. Before applying power to the meter, ensure the atmosphere is proven safe using an intrinsically safe gas detector.

⚠ WARNING

EXPLOSION HAZARD

Do not apply power to the meter with the end caps removed unless you are in a non-hazardous or explosive-free environment.

Failure to comply could result in death, serious injury and possible equipment damage.

29. Apply the sealing compound to the conduit seal fittings and allow to set in accordance with manufacturer specifications.
30. Apply electrical power to the system and verify the field connections are working correctly.
31. Do not install end caps until you configure the meter.
This completes the installation of the hardware associated with the 3810 Series Electronics meter upgrade procedure.

3 Operate

3.1 Configure the 3810 Series Electronics

1. Check all settings and wiring carefully.
2. Set up the Meter Directory, and start initial communication with the 3810 Series electronics.

The basic instructions for setting up the directory and initializing communications are contained in the following text. Refer to the 3810 Series Liquid Ultrasonic Flow Meter Installation Manual for more detailed instructions. It is recommended to use the latest version of MeterLink which can be found at www.emerson.com/meterlink. For Rosemount Ultrasonic 3810 Series electronics with v1.60 and later firmware, MeterLink v1.90 or later is required.

3.1.1 Initial communication connection using Ethernet

Ethernet initial connection material checklist

The following materials and information are required:

- 3810 Ethernet adapter cable
- Personal computer (PC) configured as follows:
 - MeterLink software installed
 - Ethernet port
 - Configured to automatically obtain IP address (via DHCP)

Ethernet initial connection steps

Procedure

1. Power up the 3810 Series meter and wait two minutes for the meter to startup.
2. Ensure that the Ethernet DHCP server is enabled on the 3810 CPU Module by setting DHCP switch to the **ON** position.
3. Plug the Ethernet adapter cable into the meter CPU Module and connect the RJ45 end into the PC Ethernet connector.
4. Verify the Ethernet connection status by the 3810 CPU Module **LINK** LED which should be solid green.
5. Start MeterLink™ on the PC. The **Connect to Meter** dialog displays.
 - a) Click the **Edit Meter Directory** button.
 - b) Click the **Add** button (below the **Meter Directory** file operations field). MeterLink inserts the **New Meter** record in the last field in the **Meter Directory** table.
6. Create a new meter directory record with the following parameters:
 - a) Enter a name for the meter.
 - b) Select Meter Type as Gas or Liquid as appropriate.
 - c) Check the Ethernet box and uncheck the Direct and Modem boxes.

- d) Set the Ethernet IP address to 192.168.135.100.
 - e) Close the Meter Directory window.
7. Use the `Meter|Connect` menu path and click the **Ethernet** connection for the meter record established in the previous step. MeterLink™ will now connect to the meter. For Rosemount 3810 Series Firmware v1.60 and later, MeterLink will display a **Meter Login** dialog box and require a valid username and password to be entered to make a connection. The default username for a 3810 Series electronics from the factory is administrator. The default password is Administrator-XXXXX where XXXXX is the non-zero padded CPU serial number which can be found on a label on the CPU Module. MeterLink v1.90 or later is required to make a connection to a meter requiring user authentication. See **Manage Users** in the Rosemount 3810 Series Liquid Ultrasonic Flow Meters: Operations Manual for more details on setting up users, user types and passwords.

3.1.2 Initial communication connection using RS-232 Serial

Communications settings and Field Setup Wizard RS-232 Serial initial connection material checklist

The following materials and information are required:

- Ultrasonic serial cable
- Personal computer (PC) configured as follows:
 - MeterLink software installed
 - RS-232 serial port

RS-232 Serial initial connection steps

Procedure

1. Power up the 3810 meter and PC.
2. Plug the DB-9 end of the cable directly into the PC running MeterLink. The three wires on the other end of the cable connect to RX, TX, and COM terminals on the CPU Module. The Digital Out wire goes to RX, the Digital In wire goes to TX, and the COMMON wire goes to COM.

Figure 3-1: CPU RS-232 serial connection

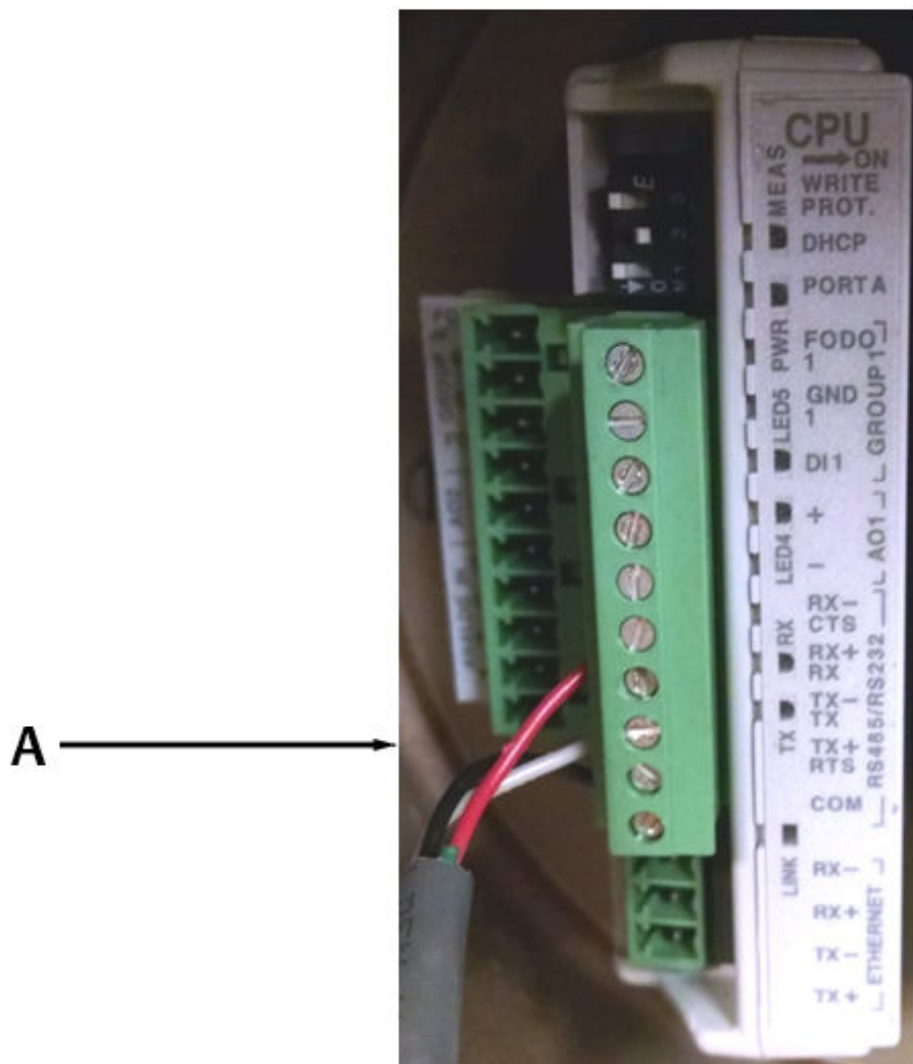

A. Serial connection

Table 3-1: CPU RS-232 wire colors

CPU	Wire colors
R X	Red
T X	White
C O M	Black

3. Start MeterLink™ on the PC and create a new Meter Directory record with the following parameters:

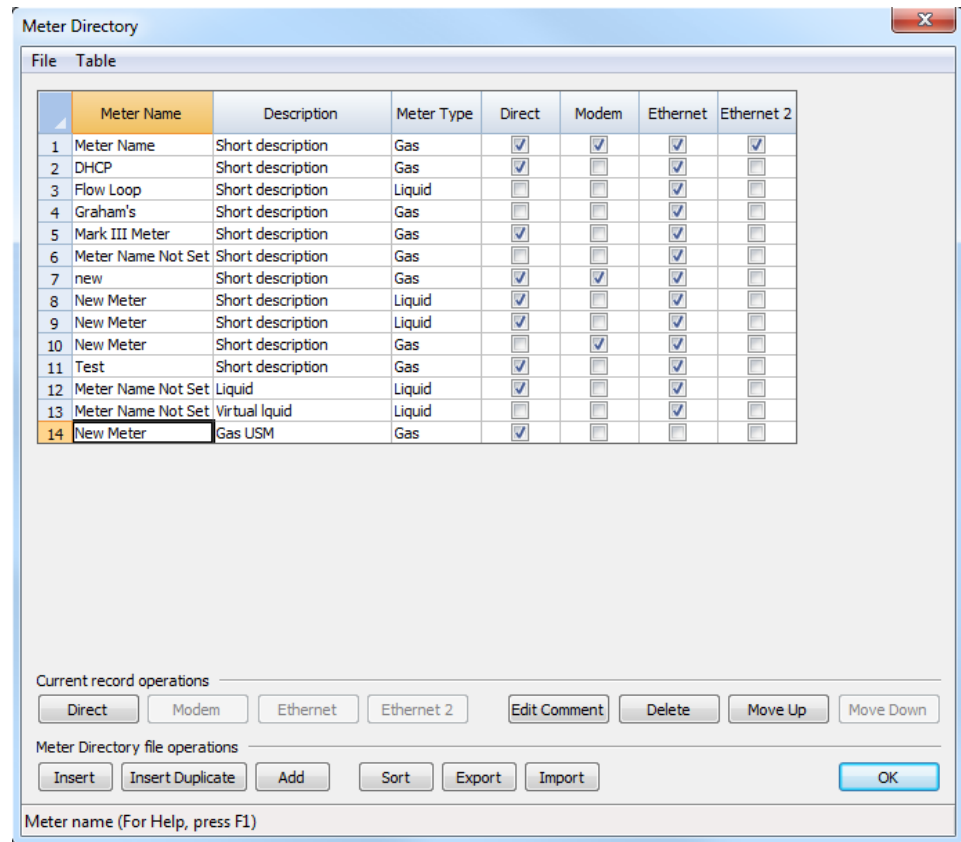

- a) Enter a name.
- b) Select **Meter Type** as Gas or Liquid as appropriate.
- c) Check the **Direct** box and uncheck the Modem and Ethernet boxes.
- d) Set the Direct connection properties for Baud Rate of 19200 and Comms Address (Modbus ID) of 32.

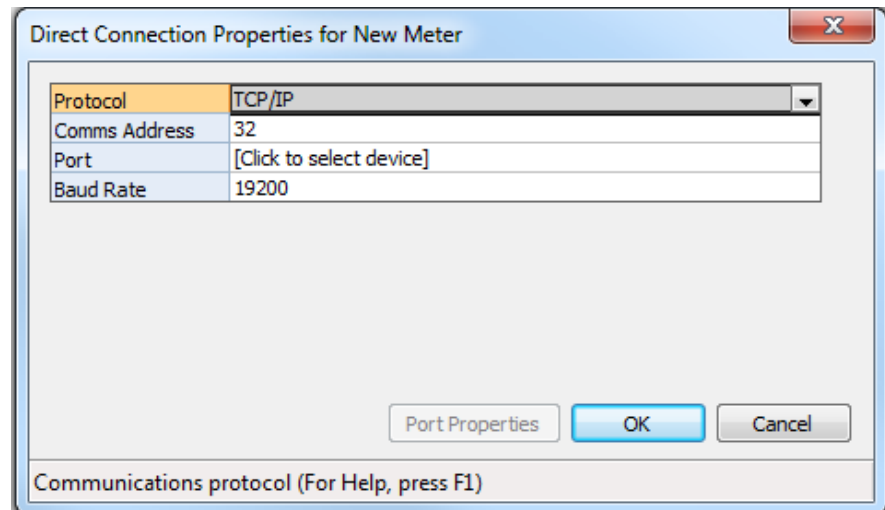

4. Use the **Meter|Connect** menu path and click **Direct** connection for the meter record established above. MeterLink™ will now connect to the meter. For Rosemount 3810 Series Firmware v1.60 and later, MeterLink will display a **Meter Login** dialog box and require a valid username and password to be entered to make a connection. The default username for a meter from the factory or for a meter upgraded from a firmware version prior to v1.60 is administrator. The default password is Administrator-XXXXX where XXXXX is the non-zero padded CPU serial number which can be found on a label on the CPU Module. MeterLink v1.90 or later is required to make a connection to a meter requiring user authentication. See **Manage Users** in the Rosemount 3810 Series Liquid Ultrasonic Flow Meters: Operations Manual for more details on setting up users, user types and passwords.

Meter Communications Settings

Procedure

1. Use the `Meter|Communications Settings` menu path to access the **Communications** dialog.
This dialog displays the communications parameters for the 3810 Series electronics and is used to adjust the Baud Rate and Comms Address (i.e. Modbus ID) for the serial ports.

Figure 3-2: Communications Settings dialog

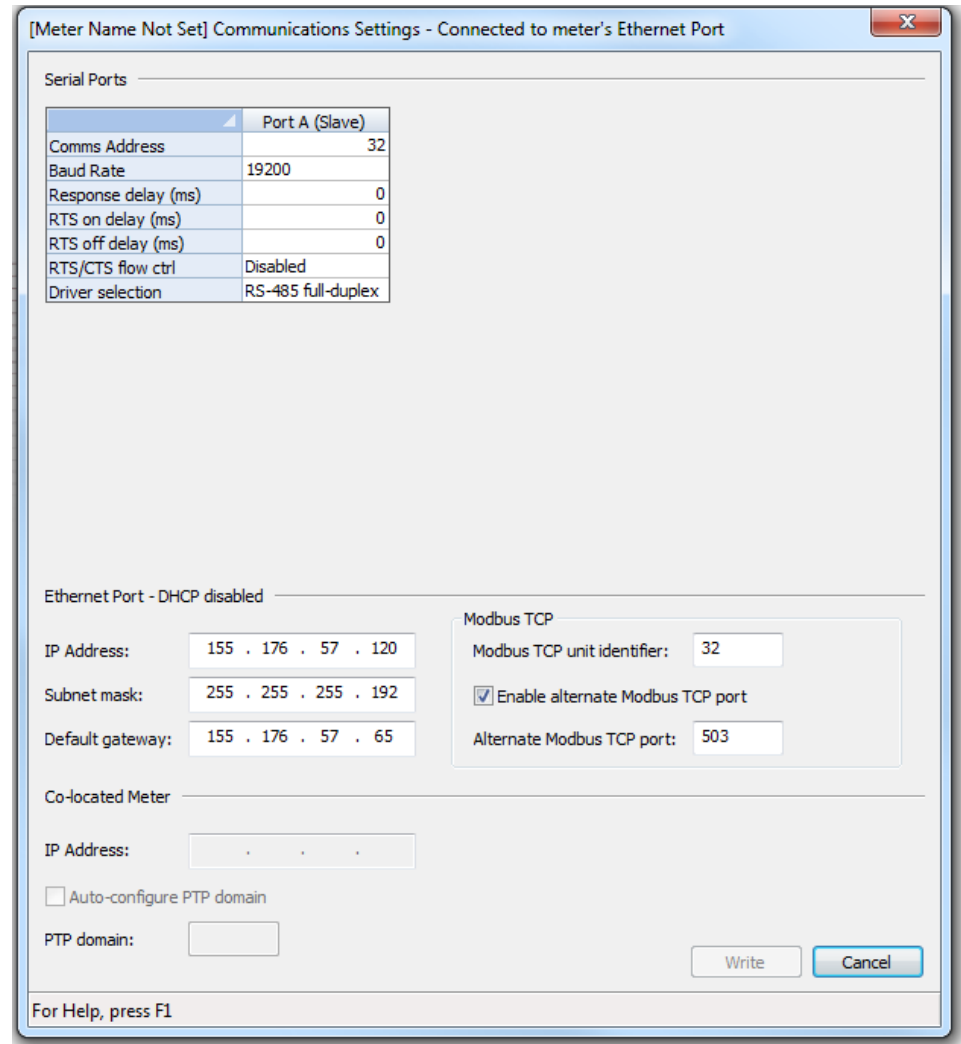

2. Use the **Driver selection** pull-down menu if communication settings require RS-485.

Figure 3-3: Change driver selection for RS-485 half duplex or full duplex communication

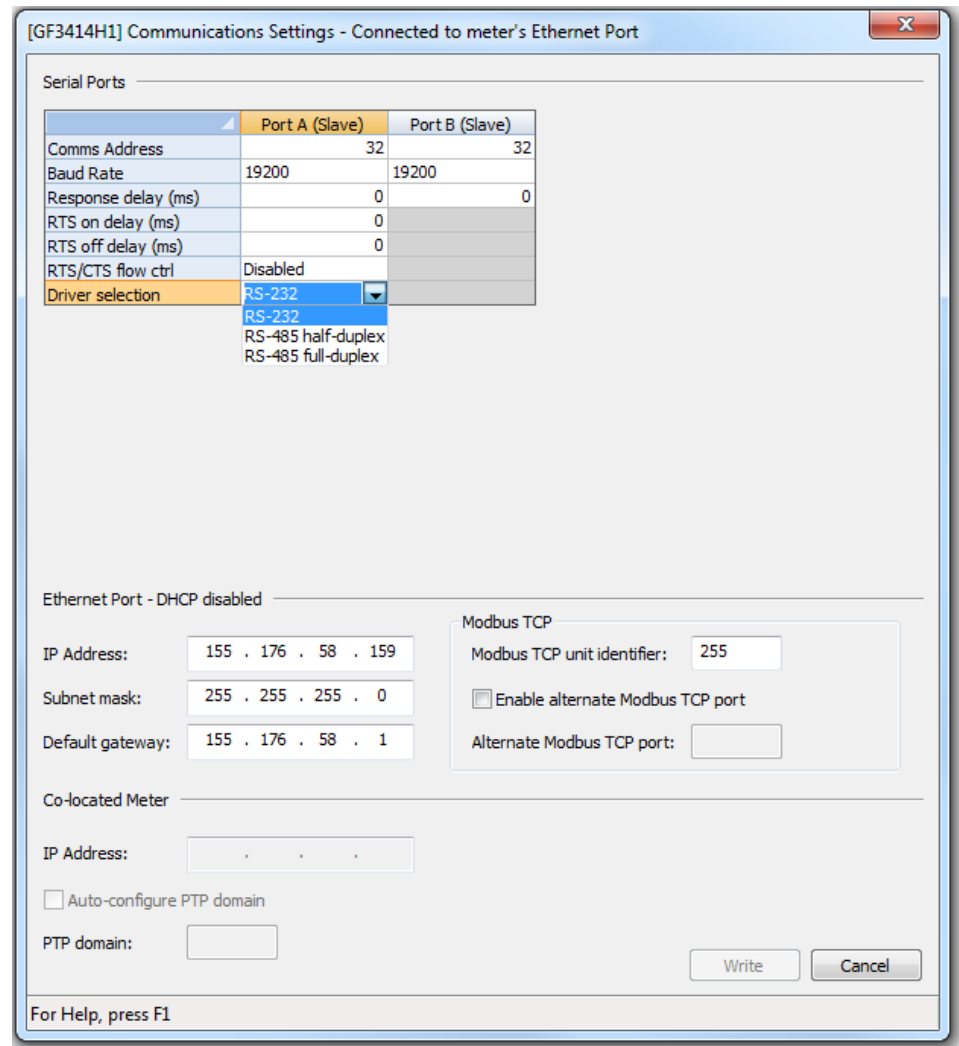

3.1.3 Write the converted configuration file to the meter

Procedure

1. With communication to the meter established, use the **Tools|Edit/Compare Configuration** menu path to access the **Edit/Compare Configuration** dialog.
2. Click **Open** and the **Open Configuration File** dialog displays.

Figure 3-4: Edit/Compare Configuration Dialog

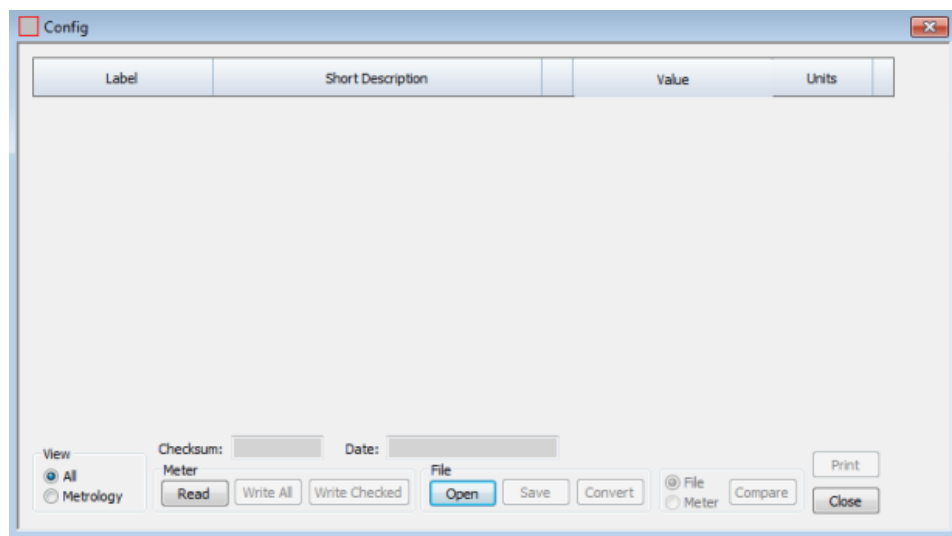

- a) Select the final 3800 Series configuration file created in [Step 2 of Procedure before removing the 3800 Series Electronics](#) of this document (i.e., "Meter Name, 3800 Series Final Config, 3-4-2005 10-15-02 AM.cfg").
- b) Click **Open**. The file opens and you returned to the Edit/Compare Configuration dialog.

Figure 3-5: Open Configuration File Dialog

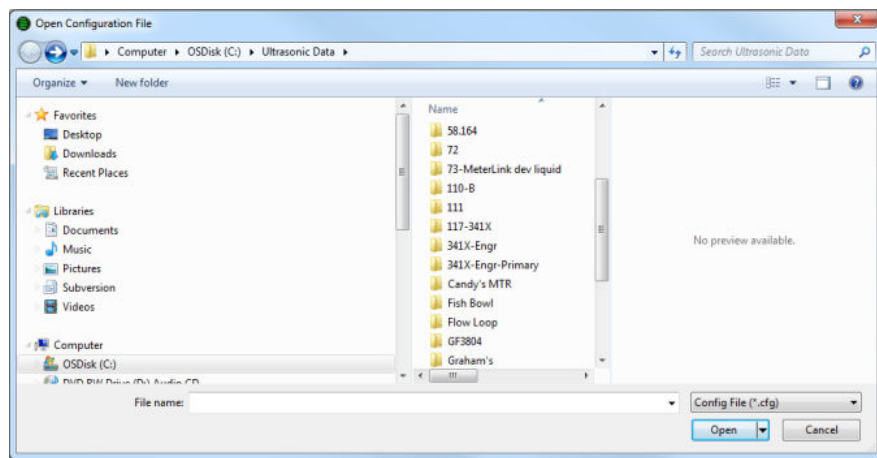

- c) Click **Convert** (see [Figure 3-6](#)). MeterLink™ reads the 3810 configuration from the meter and modifies it with the 3800 configuration.

Figure 3-6: Edit/Compare Configuration Dialog with Active Convert Button

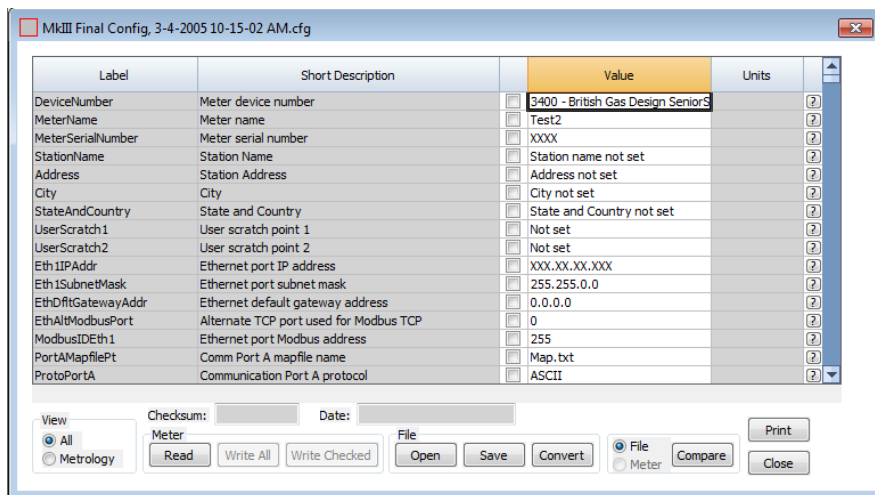

If the meter supports HART, check the 2nd variable parameter setting using the Field Setup Wizard|Current Outputs dialog. A reminder dialog prompts you to set this parameter.

Figure 3-7: HART Parameter Settings

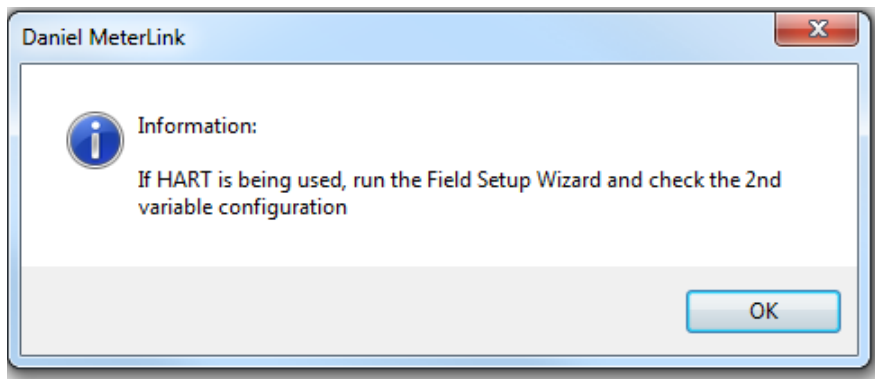

For Liquid ultrasonic meters, the HART Secondary Variable option is:

- Uncorrected flow rate

All data points shown in yellow have been modified from the 3800 configuration.

Figure 3-8: Converted Configuration with Highlighted Changes

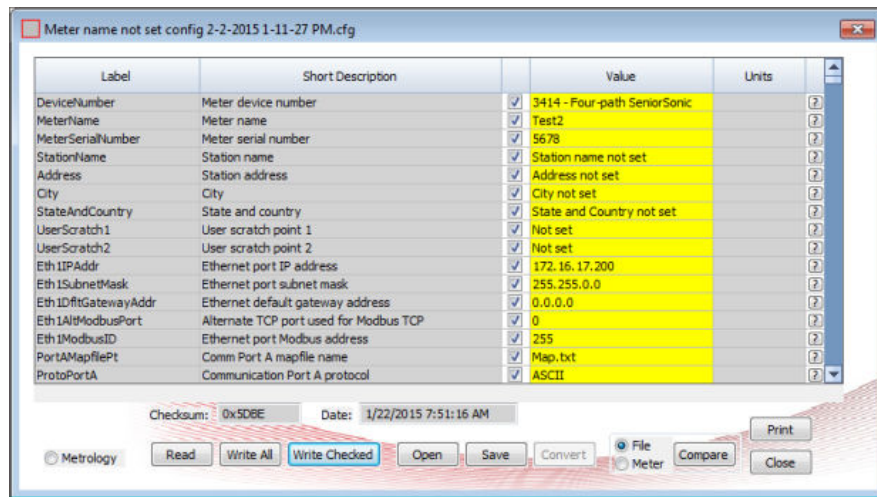

- d) Click **Write Checked** to write the converted configuration to the meter (see Figure 3-8). If an error occurs, MeterLink™ will display a message indicating the nature of the problem. Manually edit the parameter(s) with errors to successfully complete the download.
 - e) Click **Write Checked** again after modifying the parameter(s). Repeat this until the write occurs with no errors.
 - f) **Save** the 3810 Series electronics configuration file to your PC.
 - g) With the converted configuration still displayed, from the **Edit/Compare Configuration** dialog, click the **Meter** radio button, located next to the **Compare** button (see Figure 3-8).
 - h) Compare the file to verify that this saved configuration matches the meter configuration. If an error occurs, go back to the beginning of the Step 2 and try again until no errors are reported.
3. Use the Meter|Monitor menu path to display the **Monitor** window and verify that the meter is operating correctly.

Figure 3-9: Meter Monitor Dialog

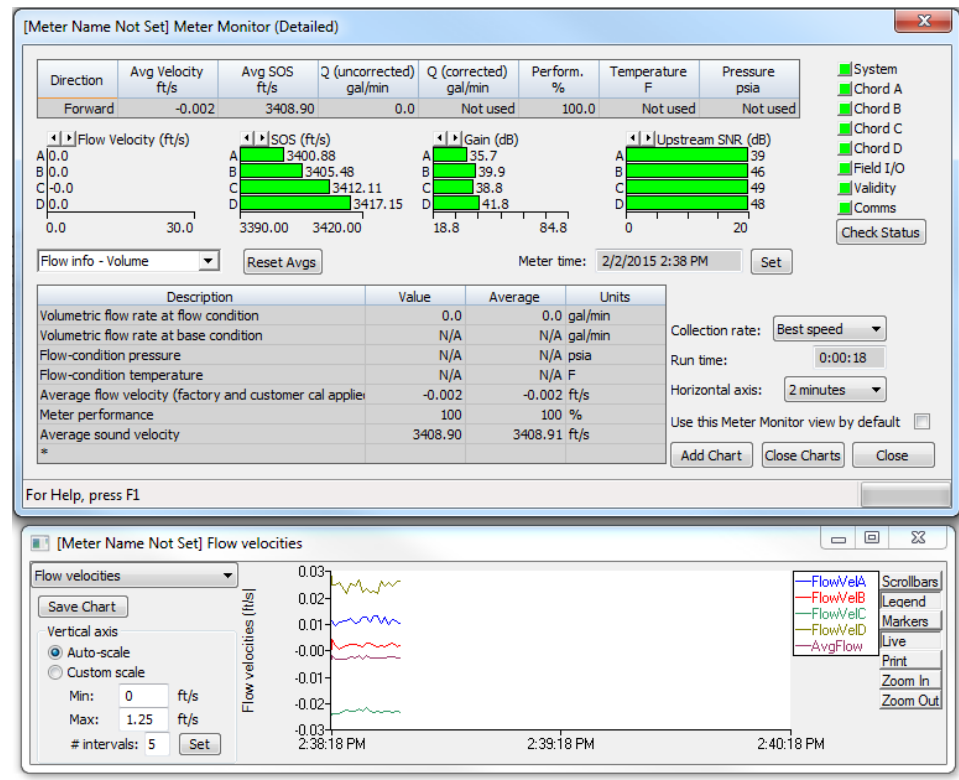

3.1.4 Configure the meter using the Field Setup Wizard

Procedure

1. Use the Meter|Field Setup Wizard menu path to access the **Field Setup Wizard Startup** dialog.
 - a) Verify that all settings (options) are correct (e.g., temperature, pressure, meter connections and meter outputs).
 - b) In the **Meter name field** insert a name for the meter (this name displays on MeterLink™ main window and the Maintenance logs and Reports files).
 - c) Ensure the 3810 Series Electronics digital outputs are configured appropriately.

Figure 3-10: Field Setup Wizard Startup Dialog

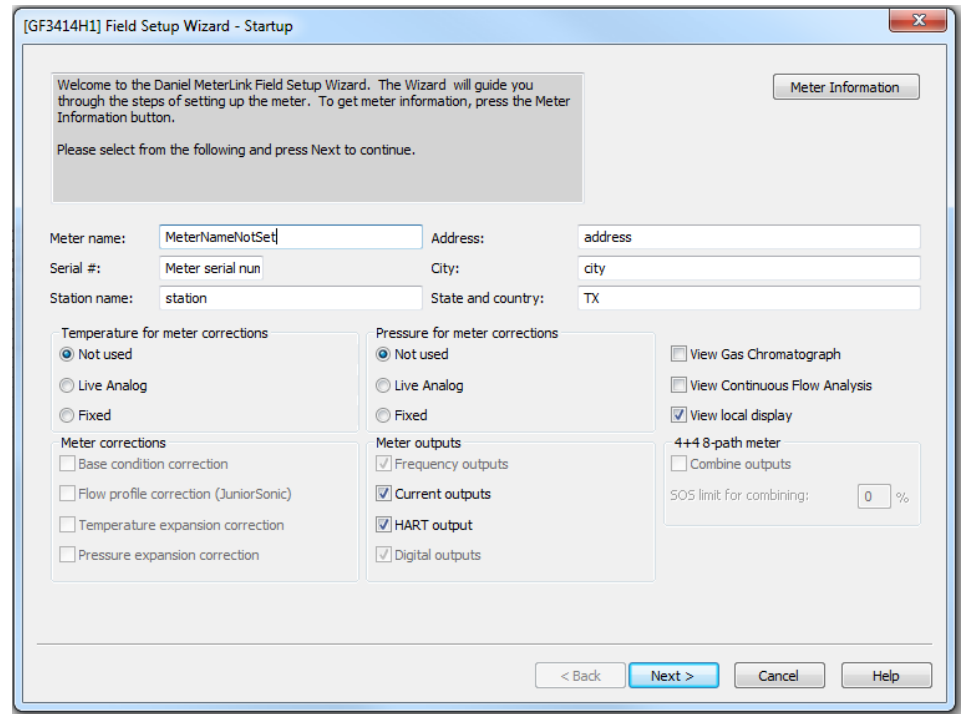

2. Setup the Frequency and Digital Output Sources parameters from the **Field Setup Wizard Frequency/Digital Outputs Sources Page**.

Figure 3-11: Field Setup Wizard Frequency and Digital Output Sources Page

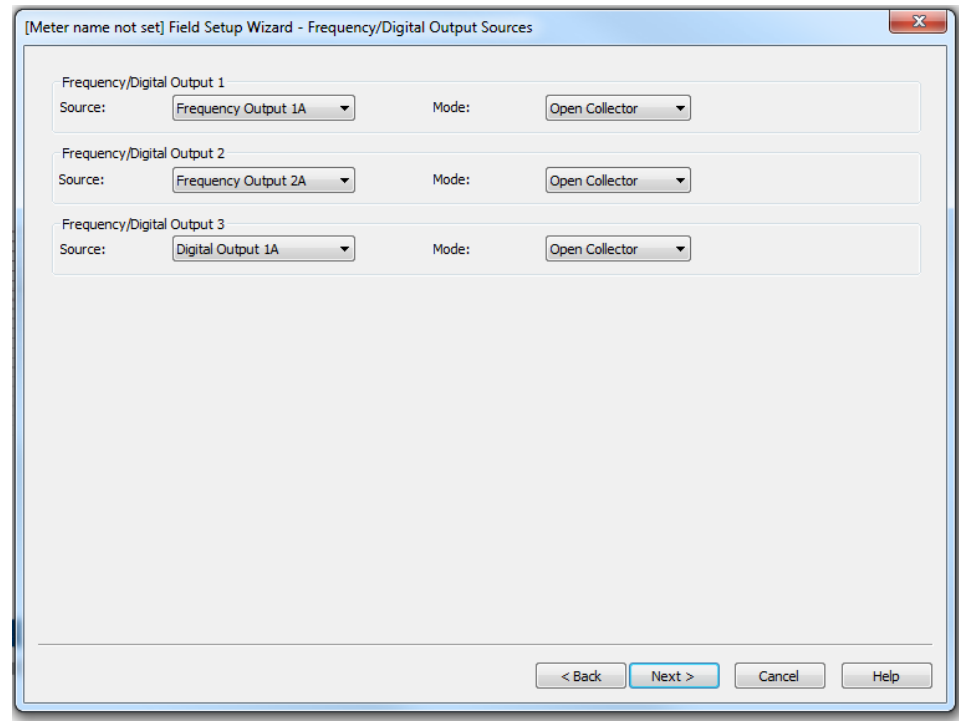

The meter has user-configurable selections for either a frequency output or digital status (FODO). Use the pull-down menus to edit these parameters.

(3) Frequency/Digital Outputs:

- FODO1 (four possible output configurations)
- FODO2 (eight possible output configurations)
- FODO3 (eight possible output configurations)

Frequency or Digital Outputs (FODO 1) source selections:

- FO1A, DO1A, FO1B, DO1B

Frequency or Digital Outputs (FODO 2) source selections:

- FO1A, DO1A, FO1B, DO1B, FO2A, DO2A, FO2B, DO2B

Frequency or Digital Outputs (FODO 3) source selections:

- FO1A, DO1A, FO1B, DO1B, FO2A, DO2A, FO2B, DO2B

Mode options:

- Open Collector (requires external excitation supply voltage and pull-up resistor)
- TTL (internally powered by the meter 0-5 VDC signal)

Channel B Phase options:

- Lag forward, Lead reverse (Phase B lags Phase A while reporting forward flow, leads Phase A while reporting reverse flow)
- Lead forward, Lag reverse (Phase B leads Phase A while reporting forward flow, lags Phase A while reporting reverse flow)

Phase A and Phase B output (based on flow direction):

- Reverse flow - output only reports flow in the reverse direction. For frequency outputs, Phase B of the output is 90 degrees out of phase with Phase A.
- Forward flow - output only reports flow in the forward direction. For frequency outputs, Phase B of the output is 90 degrees out of phase with Phase A.
- Absolute - output reports flow in both directions. For frequency outputs, Phase B of the output is 90 degrees out of phase with Phase A.
- Bidirectional - output reports flow on Phase A only in the forward direction and on Phase B only in the reverse direction.

Maximum frequency for the frequency outputs:

- 1000 Hz
 - 5000 Hz
3. If changes were made in the **Field Setup Wizard**, choose to save the configuration when MeterLink™ prompts you after the changes are written to the meter. Click **Finish** in the **Field Setup Wizard** dialog to write any changes to the meter.
 4. You have successfully completed upgrading your 3800 Series electronics to 3810 Series electronics.
 5. Save your configuration file for the meter's parameters you just set as the "As Left Settings".

3.1.5 Configure users and network security

Starting with Rosemount 3810 Series Firmware v1.60, the meter must authenticate any user making a connection to the meter using MeterLink. MeterLink will prompt for a username and password that will be authenticated by the meter before a successful connection is established. While the default password is unique to each meter, it is highly recommended to be changed at meter startup. For added security, the default username, administrator, can be changed as well. See Manage Users in the *Rosemount 3810 Series Liquid Ultrasonic Flow Meters: Operations Manual (00809-0200-3810)* for more details on setting up users, user types and passwords using the **Meter** → **Manage Users** dialog box in MeterLink.

If the Rosemount 3810 Series Electronics will be connected to a network, please read the security recommendations found in Cybersecurity and network communications in the *Rosemount 3810 Series Liquid Ultrasonic Flow Meters: Operations Manual (00809-0200-3810)*.

A Mark III Wiring I/O and switch settings

Use the wiring I/O and switch settings in this appendix to configure the 3810 Series electronics parameters.

Figure A-1: Mark III Field Connection Board Switches and Connectors

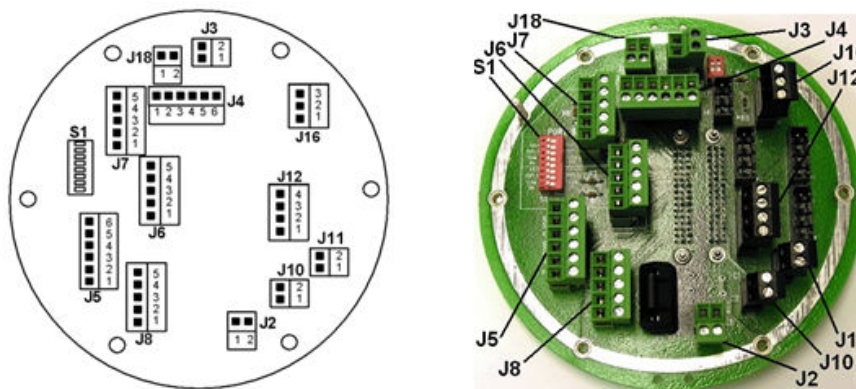

Note: The switch positions shown are the factory default positions

S1 Switch

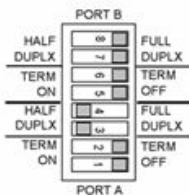

J8 - Ethernet	
Pin	
1	TX+
2	TX-
3	Chassis Ground
4	RX+
5	RX-

J18 - Digital Input	
Pin	
1	Digital In +
2	Digital In -

Power and Communications Connector Wiring

J2 - Power	
Pin	
1	10.4 - 36 vdc +
2	10.4 - 36 vdc Return

J3 - Chassis Ground	
Pin	
1	Chassis Ground
2	Chassis Ground

J4 - Outputs Group 1	
Pin	
1	Digital Out 1B
2	Digital Out 1A
3	Group 1 Ground
4	Group 1 Ground
5	Frequency Out 1B
6	Frequency Out 1A

J5 - Outputs Group 2	
Pin	
1	Digital Out 2B
2	Digital Out 2A
3	Group 2 Ground
4	Group 2 Ground
5	Frequency Out 2B
6	Frequency Out 2A

J6 - Port A			
Pin	232	485	
		Full	Half
1	RX	RX+	RX/TX+
2	TX	RX-	RX/TX-
3	Com	Com	Com
4	RTS	TX+	RX/TX+
5	CTS	TX-	RX/TX-

J7 - Port B			
Pin	232	485	
		Full	Half
1	RX	RX+	RX/TX+
2	TX	RX-	RX/TX-
3	Com	Com	Com
4	n/a	TX+	RX/TX+
5	n/a	TX-	RX/TX-

Figure A-2: Mark III CPU Boards Switches

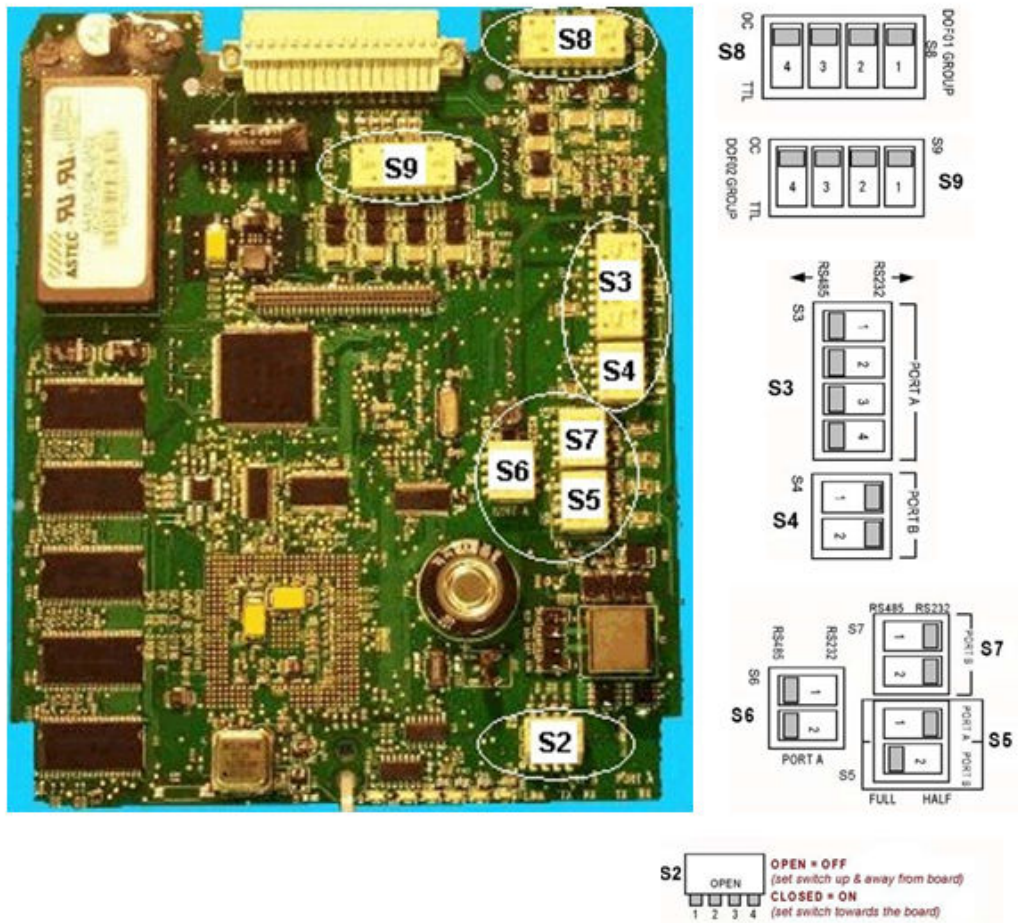

Note

The switch positions shown in the sketches of the switch banks are the factory default positions.

A.1 3800 Series RS-232 Full Duplex

Figure A-3: Port A Settings

Field Connection Board		Switch Settings										
J6 Terminations		Field Connection Board				CPU Board (S3, S5, and S6)						
Wire	Pin	S1				S3				S5	S6	
1*	2	3	4	1	2	3	4	1	1	2		
485RX+	1	TERM	TERM	FULL	FULL	RS485	RS485	RS485	RS485	FULL	RS485	RS485
485RX-	2	ON/OFF	ON/OFF	DUPLX	DUPLX							
485C	3											
485TX+	4											
485TX-	5											

Where switch setting is indicated as "TERM ON/OFF" it should be set to TERM ON if the meter is last device in multi-drop configuration OR the only meter in single drop configuration; otherwise set to TERM OFF.

Figure A-4: Port B Settings

Field Connection Board		Switch Settings								
J7 Terminations		Field Connection Board				CPU Board (S4, S5, and S7)				
Wire	Pin	S1				S4		S5	S7	
5*	6	7	8	1	2	2	1	2		
485RX+	1	TERM	TERM	FULL	FULL	RS485	RS485	FULL	RS485	RS485
485RX-	2	ON/OFF	ON/OFF	DUPLX	DUPLX					
485C	3									
485TX+	4									
485TX-	5									

Where switch setting is indicated as "TERM ON/OFF" it should be set to TERM ON if the meter is last device in multi-drop configuration OR the only meter in single drop configuration; otherwise set to TERM OFF.

A.2 3800 Series RS-485 Half Duplex

Figure A-5: Port A Settings (Factory Default Switch Settings for Port A)

Field Connection Board		Switch Settings										
J6 Terminations		Field Connection Board				CPU Board (S3, S5, and S6)						
Wire	Pin	S1				S3				S5	S6	
1*	2	3	4	1	2	3	4	1	1	2		
485RX/TX+	1	TERM	TERM	HALF	HALF	RS485	RS485	RS485	RS485	HALF	RS485	RS485
485RX/TX-	2	ON/OFF	OFF	DUPLX	DUPLX							
485C	3											
485RX/TX+	4											
485RX/TX-	5											

Where switch setting is indicated as "TERM ON/OFF" it should be set to TERM ON if the meter is last device in multi-drop configuration OR the only meter in single drop configuration; otherwise set to TERM OFF.

Figure A-6: Port B Settings

Field Connection Board		Switch Settings								
J7 Terminations		Field Connection Board				CPU Board (S4, S5, and S7)				
Wire	Pin	S1				S4		S5	S7	
		5*	6	7	8	1	2	2	1	2
485RX/TX+	1	TERM ON/OFF	TERM OFF	HALF DUPLX	HALF DUPLX	RS485	RS485	HALF	RS485	RS485
485RX/TX-	2									
485C	3									
485RX/TX+	4									
485RX/TX-	5									

Where switch setting is indicated as "TERM ON/OFF" it should be set to TERM ON if the meter is last device in multi-drop configuration OR the only meter in single drop configuration; otherwise set to TERM OFF.

A.3 3800 Series Discrete output switch settings

Figure A-7: Group 1 Frequency and Digital Outputs

Field Connection Board			CPU Board							
J4 Terminations			Settings for internally powered TTL output				Settings for open collector output			
Signal	Output	Pin	S8				S8*			
			1	2	3	4	1	2	3	4
Dig. Out1B	DO2	1	TTL	TTL	TTL	TTL	OC	OC	OC	OC
Dig. Out1A	DO1	2								
Group 1 GND		3								
Group 1 GND		4								
Freq. Out1B	Freq1B	5								
Freq. Out1A	Freq1A	6								

* Note: OC is factory default setting for S8

Figure A-8: Group 2 Frequency and Digital Outputs

Field Connection Board			CPU Board							
J5 Terminations			Settings for internally powered TTL output				Settings for open collector output			
Signal	Output	Pin	S9				S9*			
			1	2	3	4	1	2	3	4
Dig. Out2B	DO4	1	TTL	TTL	TTL	TTL	OC	OC	OC	OC
Dig. Out2A	DO3	2								
Group 2 GND		3								
Group 2 GND		4								
Freq. Out2B	Freq2B	5								
Freq. Out2A	Freq2A	6								

* Note: OC is factory default setting for S9

Figure A-9: Series 100 Option Board (If Installed)

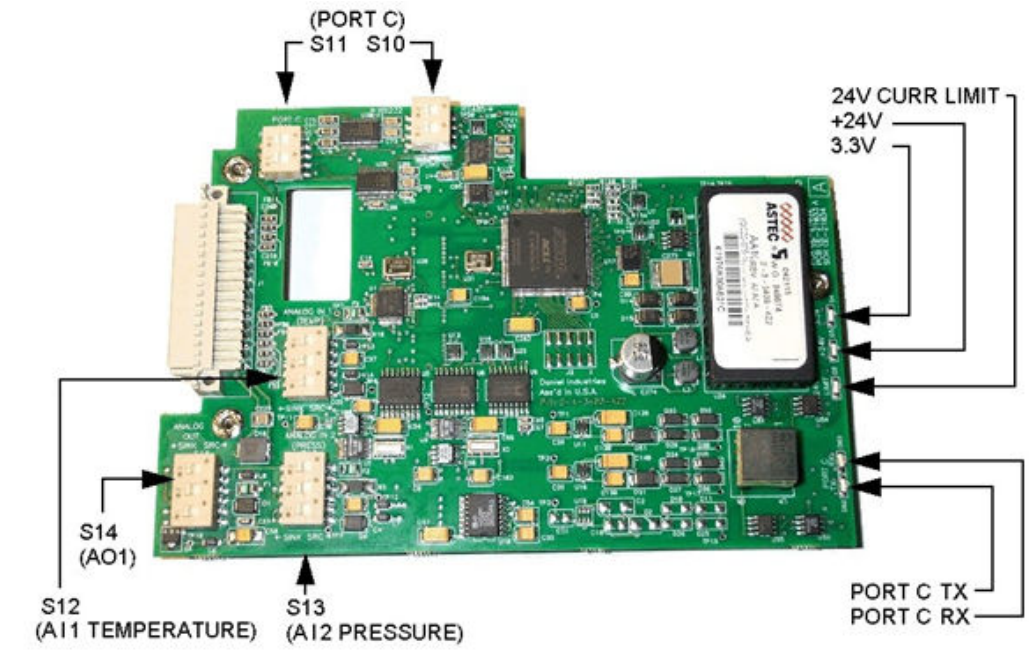

A.4 3800 Series RS-232 Full Duplex

Figure A-10: Port C Settings

Field Connection Board		Switch Settings					
		Field Connection Board		Option Board			
J16 Terminations		S2		S10		S11	
Wire	Pin	1	2	1	2	1	2
232RX	1	1	2	1	2	1	2
232TX	2	OFF	RS232	RS232	RS232	RS232	RS232
232C	3						

A.5 3800 Series RS-485 Half Duplex

Figure A-11: Port C Settings

Field Connection Board		Switch Settings			
J16 Terminations		Field Connection Board		Option Board	
Wire	Pin	S1		S11	
485RX/TX+	1	1*		1	2
485RX/TX-	2	TERM ON/OFF		RS485	RS485
485C	3			RS485	RS485

* Where switch setting is indicated as "TERM ON/OFF" it should be set to do TERM ON (switch on) if the meter is the last device in a multi-drop configuration OR the only meter is single drop configuration; otherwise set to TERM OFF (switch OFF).

A.6 3800 Series Series 100 option board (if installed)

Figure A-12: Analog Output 1

Field Connection Board			Option Board					
J11 Terminations			Settings for internally powered SOURCE output			Settings for externally powered SINK output		
Signal	Output	Pin	S14			S14*		
Analog Output+	AO1+	1	1	2	3	1	2	3
Analog Output-	AO1-	2	SRC	SRC	SRC	SINK	SINK	SINK

* Note: SINK is factory default setting for S14.

Figure A-13: Analog Input 1 (Temperature)

Field Connection Board			Option Board					
J12 Terminations			Settings for internally powered SOURCE input			Settings for externally powered SINK input		
Signal	Input	Pin	S12			S12*		
Analog Input1+	AI1+	1	1	2	3	1	2	3
Analog Input1-	AI-	2	SRC	SRC	SRC	SINK	SINK	SINK

* Note: SINK is factory default setting for S12.

Figure A-14: Analog Input 2 (Pressure)

Field Connection Board			Option Board					
J12 Terminations			Settings for internally powered SOURCE input			Settings for externally powered SINK input		
Signal	Input	Pin	S13			S13		
Analog Output2+	AI2+	3	1	2	3	1	2	3
Analog Output2-	AI2-	4	SRC	SRC	SRC	SINK	SINK	SINK

* Note: SINK is factory default setting for S13.

Figure A-15: Series 100 Plus HART Option Board (If Installed)

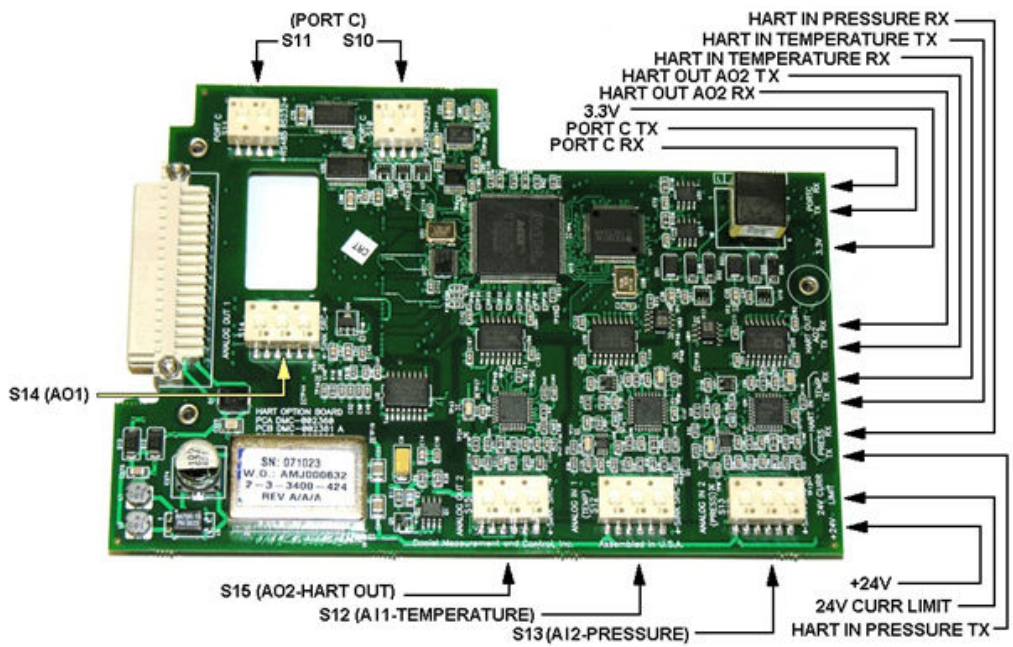

A.7 3800 Series RS-232 Full Duplex

Figure A-16: Port C Settings

Field Connection Board		Switch Settings			
J16 Terminations		Field Connection Board		Option Board	
Wire	Pin	S2	S10		S11
232RX	1	1	1	2	1
232TX	2	OFF	RS232	RS232	RS232
232C	3				RS232

A.8 3800 Series RS-485 Half Duplex

Figure A-17: Port C Settings

Field Connection Board		Switch Settings			
J16 Terminations		Field Connection Board		Option Board	
Wire	Pin	S2	S10		S11
485RX/TX+	1	1*	1	2	1 2
485RX/TX-	2				
485C	3	TERM ON/OFF	RS485	RS485	RS485 RS485

* Where switch setting is indicated as "TERM ON/OFF" it should be set to do TERM ON (switch on) if the meter is the last device in a multi-drop configuration OR the only meter in single drop configuration; otherwise set to TERM OFF (switch OFF).

A.9 3800 Series Series 100 plus HART option board (if installed)

Figure A-18: Analog Output 1

Field Connection Board			Option Board					
J11 Terminations			Settings for internally powered SOURCE output			Settings for externally powered SINK output		
Signal	Output	Pin	S14			S14*		
Analog Output+	AO1+	1	1	2	3	1	2	3
Analog Output-	AO1-	2	SRC	SRC	SRC	SINK	SINK	SINK

* Note: SINK is factory default setting for S14.

Figure A-19: Analog Output 2 (HART capable)

Field Connection Board			Option Board					
J10 Terminations			Settings for internally powered SOURCE output			Settings for externally powered SINK output		
Signal	Output	Pin	S15			S15*		
Analog Output+	AO2+	1	1	2	3	1	2	3
Analog Output-	AO2-	2	SRC	SRC	SRC	SINK	SINK	SINK

* Note: SINK is factory default setting for S15.

Figure A-20: Analog Input 1 (Temperature)

Field Connection Board		
J12 Terminations		
Signal	Input	Pin
Analog Input1+	AI1+	1
Analog Output1-	AO1-	2

Option Board					
Settings for internally powered SOURCE input			Settings for externally powered SINK input		
S12			S12*		
1	2	3	1	2	3
SRC	SRC	SRC	SINK	SINK	SINK

* Note: SINK is factory default setting for S12.

Figure A-21: Analog Input 2 (Pressure)

Field Connection Board		
J12 Terminations		
Signal	Input	Pin
Analog Output2+	AI2+	3
Analog Output2-	AO2-	4

Option Board					
Settings for internally powered SOURCE input			Settings for externally powered SINK input		
S13			S13		
1	2	3	1	2	3
SRC	SRC	SRC	SINK	SINK	SINK

* Note: SINK is factory default setting for S13.

B Summary table of communications/output settings

Based on switch position on the 3800 CPU board and Option board if installed, indicate the appropriate configuration for each communication/output parameters on the 3800 electronics. Use these parameters to configure the 3810 Series electronics.

Table B-1: Communications/Output Settings Summary Table

Output type	(Check electronics switch settings and circle appropriate box for each output)			
Serial port A	Not used (if J6 not used)	RS-232 (if S3 is set to RS232)	RS-485 Half Duplex (if S3 is set to RS-485 and S5-1 is set to Half)	RS-485 Full Duplex (if S3 is set to RS-485 and S5-1 is set to Full)
Serial port B	Not used (if J7 not used)	RS-232 (if S4 is set to RS232)	RS-485 Half Duplex (if S4 is set to RS482 and S5-2 is set to Half)	RS-485 Full Duplex (if S4 is set to RS-485 and S5-2 is set to Full)
Serial port C	Not used (if J16 not used)	RS-232 (if S10 is set to RS232)	RS-485 Half Duplex (if S10 is set to RS-485)	
Digital output 1A	Not used (if J4-2 not used)	TTL (if S8-1 is set to TTL)	Open Collector (if S8-1 is set to OC)	
Digital output 1B	Not used (if J4-1 not used)	TTL (if S8-2 is set to TTL)	Open Collector (if S8-2 is set to OC)	
Frequency output 1A	Not used (if J4-1 not used)	TTL (if S8-3 is set to TTL)	Open Collector (if S8-3 is set to OC)	
Digital output 2A	Not used (if J5-2 not used)	TTL (if S9-1 is set to TTL)	Open Collector (if S8-1 is set to OC)	
Digital output 2B	Not used (if J5-2 not used)	TTL (if S9-2 is set to TTL)	Open Collector (if S9-2 is set to OC)	
Frequency output 1B	Not used (if J5-1 not used)	TTL (if S8-4 is set to TTL)	Open Collector (if S8-4 is set to OC)	
Frequency output 2A	Not used (if J5-6 not used)	TTL (if S9-3 is set to TTL)	Open Collector (if S9-3 is set to OC)	

**Table B-1: Communications/Output Settings Summary Table
(continued)**

Output type	(Check electronics switch settings and circle appropriate box for each output)			
Frequency output 2B	Not used (if J5-5 not used)	TTL (If S9-4 is set to TTL)	Open Collector (if S9-4 is set to OC)	
Analog input 1	Not used (if J12-1 not used)	Source (if S12 is set to SRC)	Sink (if S12 is set to SINK)	
Analog input 2	Not used (if J12-3 not used)	Source (if S13 is set to SRC)	Sink (if S13 is set to SINK)	
Analog output 1	Not used (if J11 not used)	Source (if S14 is set to SRC)	Sink (if S14 is set to SINK)	
Analog output 2 (HART Capable)	Not used (if J10 not used)	Source (if S15 is set to SRC)	Sink (if S15 is set to SINK)	

Enter the results of the 3800 Summary Table of Communications/output settings in the table below as a quick reference to setup the 3810 Series meter configuration parameters.

Table B-2: Communications/Output Settings Summary Table Results

Output type	Enter communications and output settings			
Serial port A				
Serial port B				
Serial port C ⁽¹⁾				
Digital output 1A				
Digital output 1B				
Frequency output 1A				
Digital output 2A				
Digital output 2B				
Frequency output 1B				
Frequency output 2A				
Frequency output 2B				
Analog input 1				
Analog input 2				
Analog output 1				

Table B-2: Communications/Output Settings Summary Table Results (continued)

Output type	Enter communications and output settings			
Analog output 2 (HART Capable)				

(1) Port B and C are not available for 3810 Series electronics in default configuration. Port B is available for 3810 Series electronics with Optional I/O RS-232, RS-485 or Expansion I/O Modules installed.

C 3810 Communication and Output settings

C.1 3810 Wiring and I/O

Refer to the 3810 Series Ultrasonic Liquid Flow Meter Installation Manual for more wiring details.

Figure C-1: CPU Module Labeling and LED Indicators

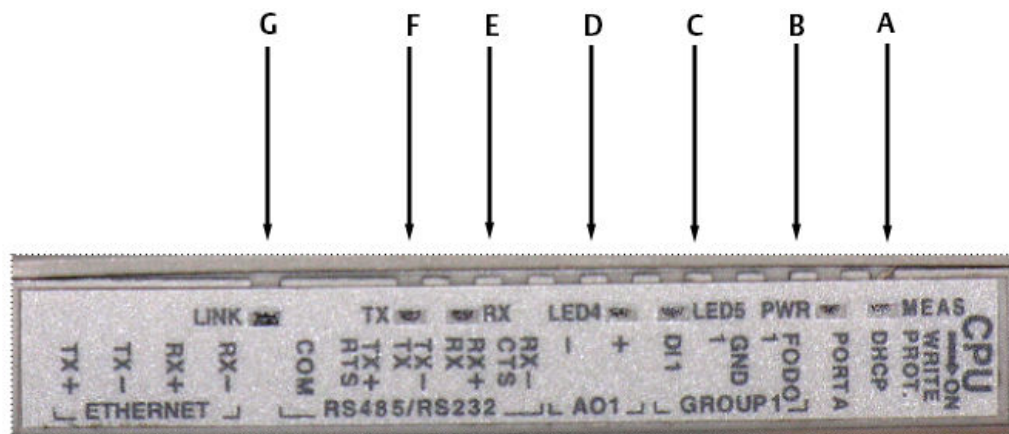

- A. Acquisition/Measurement mode
- B. Power
- C. LED 5 - not used
- D. LED 4 - not used
- E. RX (RS-485/RS-232) - receiving data
- F. TX (RS-485/RS-232) - transmitting data (RS-485 2-wire use TX+ and TX-)
- G. Link (Eth1Link) - user Ethernet connection

Table C-1: CPU Module Labeling and LED Functions

CPU Module label or LED	Function	Switch position indicator or LED
WRITE PROT.	Write-protect mode - with switch in the ON position (default setting) protects configuration and firmware overwrites. To write configuration changes or download firmware to the meter, change the switch to the OFF position.	Switch position <ul style="list-style-type: none"> • ON - (default setting) enables write-protection of the configuration and firmware • OFF - enables writing configuration changes or downloading firmware

Table C-1: CPU Module Labeling and LED Functions (continued)

DHCP	<p>Dynamic Host Protocol Server - enables you to communicate with a Rosemount™ Ultrasonic meter that is not connected to a network.</p> <p>When the CPU Module switch is in the ON position, the meter is enabled to act as a DHCP server for a single DHCP client connected to the Ethernet port using a crossover cable. This should be used for peer to peer connections only.</p> <p>When the connection is made, select to use the Meter Name in the meter instead of the Meter Directory Name in order to keep all log files and configurations separate from each meter.</p>	<p>Switch position</p> <ul style="list-style-type: none"> • ON - the meter is enabled to act as a DHCP server for a single DHCP client • OFF - disables the DHCP server
PORT A	<p>PORT A override - RS-232 serves as an override during meter commissioning to establish communications and in the event the user cannot communicate with the meter due to an inadvertent communication configuration change. The override period is for two minutes. Supports:</p> <ul style="list-style-type: none"> • auto-detected ASCII (Start bit 1, Data Bit 7, Parity Odd/Even, Stop Bit 1) • RTU (Start Bit 1, Data Bit 8, Parity none, Stop Bit 1). • Modbus protocols RS-232 Baud rate=19,200 Modbus ID=32 	<p>Switch position</p> <ul style="list-style-type: none"> • ON - enables RS-232 PORT A override • OFF - (default setting) disables RS-232 PORT A override
MEAS	<p>System color indicates metrology mode Acquisition mode</p> <p>Measurement mode</p>	<p>LED status</p> <ul style="list-style-type: none"> • Red flashing LED • Solid red the Acquisition Module is not communicating with the CPU Module • Green flashing LED
PWR	3.3 V Power Indicator	Solid Green
LED 4	Not used	
LED 5	Not used	
RX	RX signal (Port A for RS485 or RS232 communication) receiving data	Flashing green (when receiving data)

Table C-1: CPU Module Labeling and LED Functions (continued)

TX	TX signal (Port A for RS485; 2-wire or 4-wire or RS232 communication) transmitting data	Flashing green (when transmitting data)
LINK	ETH1Link user Ethernet connection	Solid green

C.2 Ethernet cable to PC communication

The Ethernet port IP address, subnet mask, and gateway address are software-configurable. In addition, a meter can be configured to act as a DHCP (Dynamic Host Configuration Protocol) server to assign an IP address to a PC or laptop running MeterLink. The DHCP server facility is not intended to act as a general purpose DHCP server for a wider network. To this end, no user control is provided over the class or range of IP addresses the unit provides. A standard twisted pair (Cat-5) cable should be used for Ethernet wiring.

It is strongly recommended that the meter be configured using an independent (off-network) single host. After configuration of the 3810 Series Liquid Ultrasonic Flow Meter, the DHCP option must be turned off if used on a LAN/WAN.

NOTICE

RESTRICTED ETHERNET AND SERIAL CONNECTIVITY USAGE

Failure to restrict Ethernet and communication access to the 3810 Series Liquid Ultrasonic Flow Meter can result in, among other things, unauthorized access, system corruption, and/or data loss.

User is responsible for ensuring that physical access and Ethernet or electronic access to the 3810 Series Liquid Ultrasonic Flow Meter is appropriately controlled and any necessary security precautions are implemented; such as, establishing a firewall, setting password permissions and/or implementing security levels.

Table C-2: Ethernet Communication

Ethernet	
Wire color	CPU/EXP
White with green Stripe	TX+
Solid green	TX-
White with orange stripe	RX+
Solid orange	RX-
<p>Note Wiring colors for TX+/TX- and RX+/RX- can be switched as ethernet ports will automatically detect crossover vs. straight connection. Connections shown are straight through cable.</p>	

The diagram shows a 48-pin DIN connector with three Ethernet ports labeled Port 1, Port 2, and Port 3. Each port has four pins: TX+, TX-, RX+, and RX-. The pins are color-coded: green for Port 1, orange for Port 2, and blue for Port 3. Arrows point from the labels to the corresponding pins on the connector.

Ethernet Communication

Use ethernet cable, to connect the PC to the meter.

A DIN 41612 48-pin connector is the interface from the CPU Module to the Backplane (male end located on the back of the Backplane Board).

C.3 Input and output connections

The Rosemount 3810 Series Ultrasonic Flow Meter provides the Analog inputs for pressure and temperature, Analog output 2 and frequency and digital outputs on the CPU Module lower terminal block.

Figure C-2: CPU Module Lower Terminal Block I/O Connections

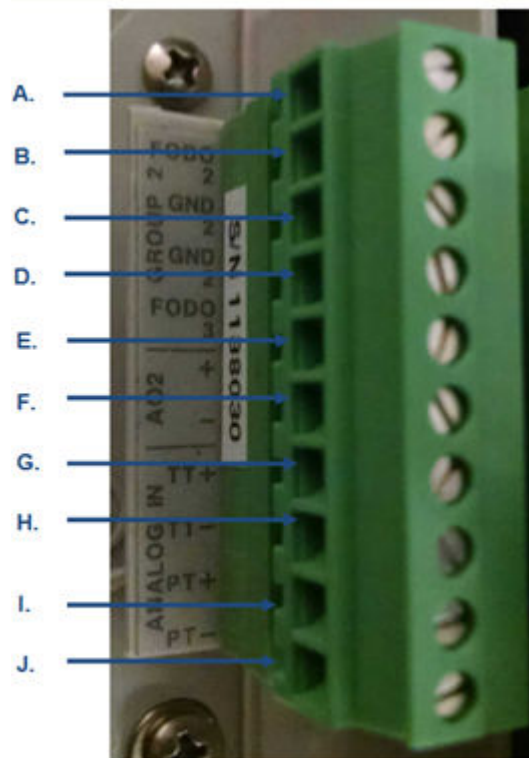

- A. Frequency/Digital output 2 (FODO 2)
- B. Frequency/Digital output 2 (FODO 2) Gnd
- C. Frequency/Digital output 2 (FODO 2) Gnd
- D. Frequency/Digital output 3 (FODO 3)
- E. Analog output 2 + (4-20 mA output)
- F. Analog output 2 - (4-20 mA output)
- G. Analog in (Temperature) +
- H. Analog in (Temperature) -
- I. Analog in (Pressure) +
- J. Analog in (Pressure) -

Possible configurations for Frequency and Digital Outputs are shown in the following figure.

Figure C-3: Frequency/Digital Output

Frequency/Digital output	Source configuration
Frequency /Digital Output 1 ¹	<ul style="list-style-type: none"> • Frequency output 1A • Frequency output 1B • Digital output 1A • Digital output 1B
Frequency /Digital Output 2 ² or Frequency /Digital Output 3 ²	<ul style="list-style-type: none"> • Frequency output 1A • Frequency output 1B • Digital output 1A • Digital output 1B • Frequency output 2A • Frequency output 2B • Digital output 2A • Digital output 2B

1. Solid blue line denotes valid selection for Frequency/Digital Output 1.
2. Black dashed -line denotes valid selections for Frequency/Digital Output 2 and Frequency/Digital Output 3.

Output for FODO1 and Digital Output1 (Group 1 on the CPU Module upper terminal block) share a common ground and have 50 V isolation. FODO2 and FODO3 (Group 2 on the CPU Module lower terminal block) share a common ground and have 50 V isolation. This allows an output to be connected to a different flow computer. The outputs are opto-isolated from the CPU Module and have a withstand voltage of at least 500 V rms dielectric.

Figure C-4: CPU Module - Frequency/Digital Outputs Common Ground - Type 2

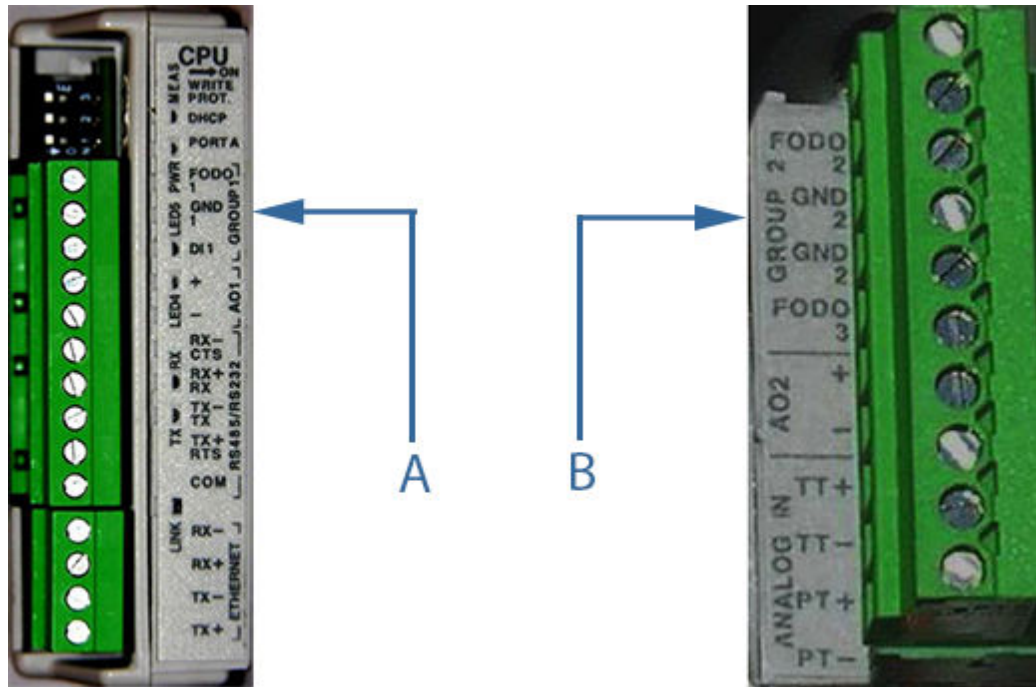

- A. FODO1 and Digital input1 - shared common ground (Group1)
- B. FODO2 and FODO3 - shared common ground (Group2)

Figure C-5: CPU Module - Frequency/Digital Outputs Common Ground - Type 4

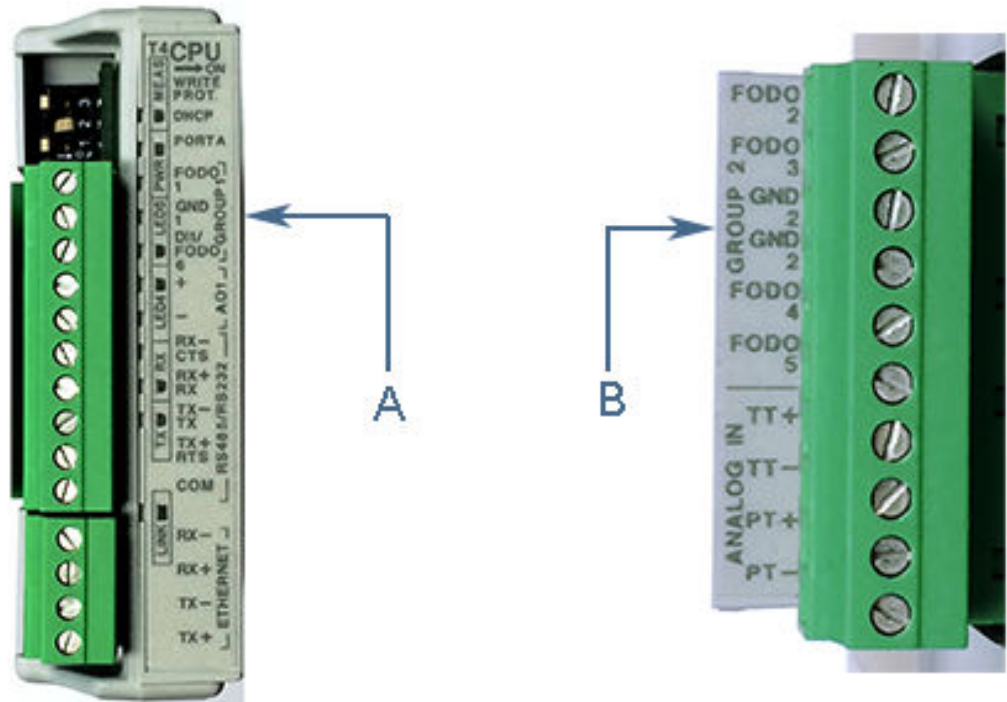

A. FODO1 and DI1/FODO6 - shared common ground - Type 4 CPU Module (Group 1)

B. FODO2, FODO3, FODO4 and FODO5 - shared common ground - Type 4 CPU Module (Group 2)

C.4 Serial communications

Use a serial cable, to connect to a PC running MeterLink™. The cable is designed for RS-232 communications which is the serial Port A default configuration (see [3810 Series engineering drawings](#) Systems Wiring Diagram, Drawing DMC - 004936).

The DB-9 end of the cable plugs directly into the PC running MeterLink. The three wires on the other end of the cable connect to the CPU Module RS-485/RS-232 terminals. The RED wire goes to RX, the WHITE wire goes to TX, and the BLACK wire goes to COM (see Table 3-5 for Port A wiring).

RS-485, 2-wire connection on Port A, uses TX+ and TX- on the CPU Module and has a ground wire.

When Belden wire No. 9940 or equivalent is used, the maximum cable length for RS-232 communications at 9600 bps is 88.3 meters (250 ft.) and the maximum cable length for RS-485 communication at 57600 bps is 600 meters (1970 ft.).

Port A supports a special override mode which forces the port to use known communication values (19200 baud, address 32, RS-232). Note that the protocol is auto-detected. This mode is expected to be used during meter commissioning (to establish initial communication) and in the event that the user cannot communicate with the meter (possibly due to an inadvertent communication configuration change). Alternately, when using MeterLink with an Ethernet port, use Ethernet cable, to connect the PC.

Table C-3: Serial Port Parameters

Port/communication	Description	Common features
<ul style="list-style-type: none"> Port A (Standard) RS-232 RS-485 Half Duplex RS-485 (2-wire communication on Port A.)⁽¹⁾ 	<ul style="list-style-type: none"> Typically used for general communications with a flow computer, RTU (Modbus slave) and radios. RS-485 - 2-wire (Half Duplex) connected to TX + and TX - Special override mode to force port configuration to known settings. Supports RTS/CTS handshaking with software-configurable RTS on/off delay times. Factory default is RS-232, Address 32, 19200 baud. 	<ul style="list-style-type: none"> Communications via MeterLink using RS-232 or RS-485 Full Duplex Software configurable Modbus Address (1-247) Auto-detects TCP/IP and ASCII or RTU Protocol ASCII Protocol: <ul style="list-style-type: none"> Start Bits = 1, Data Bits = 7⁽²⁾ Parity: odd or even 1, Stop Bits = 1⁽³⁾ Baud Rates: 1200, 2400, 9600, 19200, 38400, 57600, 115000 bps RTU Protocol: Start Bits = 1, Data Bits = 8⁽⁴⁾ <ul style="list-style-type: none"> Parity: none, Stop Bits = 1⁽⁵⁾ Baud Rates: 1200, 2400, 9600, 19200, 38400, 57600, 115000 bps
Ethernet	Preferred port for diagnostic communication via MeterLink 10 Mbps/100 Mbps	Modbus TCP/IP, Modbus TCP

(1) RS-485 2-wire connections use TX+ and TX - on the CPU Module.

(2) Denotes auto-detected protocols.

(3) Denotes auto-detected protocols.

(4) Denotes auto-detected protocols.

(5) Denotes auto-detected protocols.

NOTICE

If not using Ethernet, a full duplex serial connection is necessary for MeterLink to communicate with a Rosemount 3810Series Ultrasonic Flow Meter.

Figure C-6: PC to Meter Serial Connection Wiring

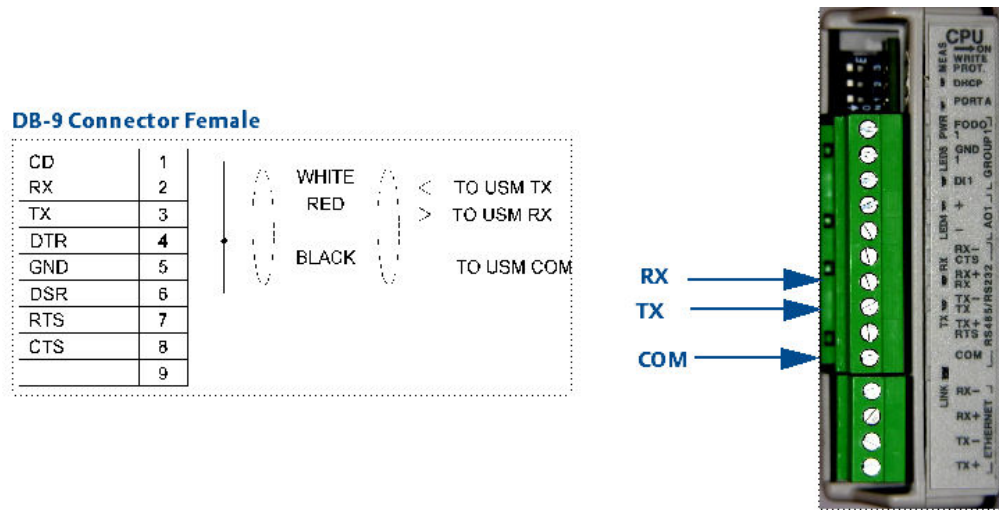

C.5 Analog input settings

The Rosemount 3810 Series Ultrasonic Flow Meter has the capability to sample analog temperature (Analog Input 1) and pressure (Analog Input 2) with 4-20 mA signals. These analog input signals are configured to sink. The two independent analog input circuits are configured for conventional 4-20 mA service. Also, 24 VDC isolated power supply connection is provided for an external power source. Refer to the System Wiring Diagram in [3810 Series engineering drawings](#).

C.6 Analog output settings

The Rosemount 3810 Series Ultrasonic Flow Meter provides two 4-20 mA analog output signals that are software configurable for either sink or source current. Refer to the System Wiring Diagram in [3810 Series engineering drawings](#).

Full HART® functionality is provided so that any commercially available HART transmitter which meets the specifications of the HART Communications Foundation can be connected to a Rosemount 3810 Series Ultrasonic Flow Meter.

C.7 Digital Input

The Rosemount 3810 Series Ultrasonic Flow Meter provides one digital input that can be used as a general purpose input. The digital input must be configured via the MeterLink™ Tools|Edit/Compare Configuration screen.

C.8 External power source connection and fuse

Located on the CPU Module are connections for a user-provided external power source, a 2 Amp fuse and a 24 V loop power connection for ultrasonic meter analog outputs, temperature transmitter or pressure transmitter devices. The current is limited to 88 mA.

Figure C-7: CPU Module Power Source Connections

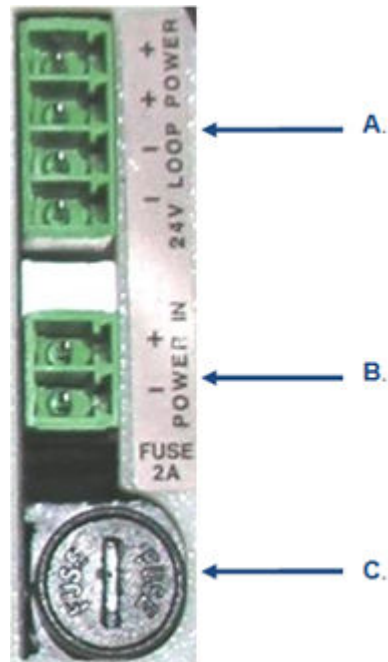

- A. 24 V Loop power
- B. Power in connector (main power source)
- C. 2 Amp fuse (used for main power input)

D 3810 Series engineering drawings

DMC-004936	3810 Series Ultrasonic Meter System Wiring Diagram
------------	--



00825-0200-3810

Rev. AC

2024

For more information: [Emerson.com/global](https://emerson.com/global)

©2024 Emerson. All rights reserved.

Emerson Terms and Conditions of Sale are available upon request. The Emerson logo is a trademark and service mark of Emerson Electric Co. Rosemount is a mark of one of the Emerson family of companies. All other marks are the property of their respective owners.

ROSEMOUNT™

