

LP-GAS SERVICEMAN'S HANDBOOK



FISHER™

EMERSON

LP-GAS SERVICEMAN'S HANDBOOK

The Emerson LP-Gas Serviceman's Handbook serves as a general reference of information on LP-Gas and for the installation, operation and maintenance of LP-Gas equipment. It provides key data and answers important questions that are relevant to management and field servicemen in the LP-Gas industry.

Users of this handbook should consult applicable federal, state and local laws as well as pertinent industry regulations, including National Fire Protection Association (NFPA) Pamphlets No. 54 and 58.

Emerson shall have no responsibility for any misinterpretation of the information contained in this handbook or any improper installation or repair work or other deviation from the procedures recommended in this handbook.

For additional copies of this handbook please contact your local Sales Office or call 1-800-558-5853, or 1-972-548-3574.

FISHER™



Table of Contents

PROPERTIES OF LP-GASES	2
VAPOR PRESSURE OF LP-GASES	4
DETERMINING TOTAL LOAD	5
VAPORIZATION RATE.....	6
CYLINDER AND TANK MANIFOLDING.....	9
CONTAINER LOCATION AND INSTALLATION	11
Container Preparation	15
PIPE AND TUBING SIZING	18
Sizing between 1st Stage and 2nd Stage Regulators.....	23
Sizing between 2nd Stage Regulator and Appliance	29
2 psi and CSST Capacities	32
LP-GAS REGULATOR INFORMATION	
Regulator Selection	37
Two-Stage Regulation	38
Regulator Installation	39
Leak Testing Methods.....	42
Regulator Inspection	44
Troubleshooting Domestic Tank Fittings.....	46
LP-Gas Orifice Capacities	48
Line Sizing Chart for Liquid Propane	49
CONVERSION FACTORS	50
FLOW EQUIVALENT CONVERSIONS.....	52
TEMPERATURE CONVERSIONS.....	52

PROPERTIES OF LP-GASES

Table 1. Approximate Properties of LP-Gases

FORMULA	PROPANE	BUTANE
	C_3H_8	C_4H_{10}
Initial Boiling Point, °F	-44	31
Specific Gravity of Liquid (Water = 1.0) at 60°F	0.504	0.582
Weight per Gallon of Liquid at 60°F, LB	4.20	4.81
Specific Heat of Liquid, BTU/LB at 60°F	0.630	0.549
Cubic feet of Vapor per Gallon at 60°F	36.38	31.26
Cubic feet of Vapor per Pound at 60°F	8.66	6.51
Specific Gravity of Vapor (Air = 1.0) at 60°F	1.50	2.01
Ignition Temperature in Air, °F	920 to 1120	900 to 1000
Maximum Flame Temperature in Air, °F	3595	3615
Cubic feet of Air Required to Burn One Cubic Foot of Gas	23.68	31.02
Limits of Flammability in Air, % of Vapor in Air-Gas Mix:		
(a) Lower	2.15	1.55
(b) Upper	9.60	8.60
Latent Heat of Vaporization at Boiling Point:		
(a) BTU per Pound	184	167
(b) BTU per Gallon	773	808
Total Heating Values After Vaporization:		
(a) BTU per Cubic Foot	2488	3280
(b) BTU per Pound	21,548	21,221
(c) BTU per Gallon	91,502	102,032

PROPERTIES OF LP-GASES

Table 1. Approximate Properties of LP-Gases (Metric)

FORMULA	PROPANE	BUTANE
	C_3H_8	C_4H_{10}
Initial Boiling Point, °C	-42	-1
Specific Gravity of Liquid (Water = 1.0) at 15.56°C	0.504	0.582
Weight per Cubic Meter of Liquid at 15.56°C, kg	504	582
Specific Heat of Liquid, kJ/kg at 15.56°C	1.464	4.276
Cubic Meter of Vapor per Liter at 15.56°C	0.271	0.235
Cubic Meter of Vapor per kg at 15.56°C	0.539	0.410
Specific Gravity of Vapor (Air = 1.0) at 15.56°C	1.50	2.01
Ignition Temperature in Air, °C	493 to 604	482 to 538
Maximum Flame Temperature in Air, °C	1980	1991
Cubic Meters of Air Required to Burn 1 Cubic Meter of Gas	23.86	31.02
Limits of Flammability in Air, % of Vapor in Air-Gas Mix:		
(a) Lower	2.15	1.55
(b) Upper	9.60	8.60
Latent Heat of Vaporization at Boiling Point:		
(a) Kilojoule per Kilogram	428	388
(b) Kilojoule per Liter	216	226
Total Heating Values After Vaporization:		
(a) Kilojoule per Cubic Meter	92,430	121,280
(b) Kilojoule per Kilogram	49,920	49,140
(c) Kilojoule per Liter	25,140	28,100

VAPOR PRESSURE OF LP-GASES

Vapor pressure can be defined as the force exerted by a gas or liquid attempting to escape from a container. This pressure moves gas along the pipe or tubing to the appliance burner.

Outside temperature greatly affects container pressure.

Lower temperature means lower container pressure.

Too low a container pressure means that not enough gas is able to get to the appliance.

The Table below shows vapor pressures for propane and butane at various outside temperatures.

Table 2. Vapor Pressures								
TEMPERATURE		APPROXIMATE VAPOR PRESSURE, psig / bar						
		PROPANE			TO	BUTANE		
°F	°C	100%	80/20	60/40	50/50	40/60	20/80	100%
-40	-40	3.6/ 0.25	----	----	----	----	----	----
-30	-34.4	8/ 0.55	4.5/ 0.31	----	----	----	----	----
-20	-28.9	13.5/ 0.93	9.2/ 0.63	4.9/ 0.34	1.9/ 0.13	----	----	----
-10	-23.3	20/ 1.4	16/ 1.1	9/ 0.62	6/ 0.41	3.5/ 0.24	----	----
0	-17.8	28/ 1.9	22/ 1.5	15/ 1.0	11/ 0.76	7.3/ 0.50	----	----
10	-12.2	37/ 2.6	29/ 2.0	20/ 1.4	17/ 1.2	13/ 0.90	3.4/ 0.23	----
20	-6.7	47/ 3.2	36/ 2.5	28/ 1.9	23/ 1.6	18/ 1.2	7.4/ 0.51	----
30	-1.1	58/ 4.0	45/ 3.1	35/ 2.4	29/ 2.0	24/ 1.7	13/ 0.9	----
40	4.4	72/ 5.0	58/ 4.0	44/ 3.0	37/ 2.6	32/ 2.2	18/ 1.2	3/ 0.21
50	10	86/ 5.9	69/ 4.8	53/ 3.7	46/ 3.2	40/ 2.8	24/ 1.7	6.9/ 0.58
60	15.6	102/ 7.0	80/ 5.5	65/ 4.5	56/ 3.9	49/ 3.4	30/ 2.1	12/ 0.83
70	21.1	127/ 8.8	95/ 6.6	78/ 5.4	68/ 4.7	59/ 4.1	38/ 2.6	17/ 1.2
80	26.7	140/ 9.7	125/ 8.6	90/ 6.2	80/ 5.5	70/ 4.8	46/ 3.2	23/ 1.6
90	32.2	165/ 11.4	140/ 9.7	112/ 7.7	95/ 6.6	82/ 5.7	56/ 3.9	29/ 2.0
100	37.8	196/ 13.5	168/ 11.6	137/ 9.4	123/ 8.5	100/ 6.9	69/ 4.8	36/ 2.5
110	43.3	220/ 15.2	185/ 12.8	165/ 11.4	148/ 10.2	130/ 9.0	80/ 5.5	45/ 3.1

DETERMINING TOTAL LOAD

The best way to determine BTU input is from the appliance nameplate or from the manufacturer's catalog. Add the input of all the appliances for the total load. If specific appliance capacity information is not available, Table 3 below will be useful. Remember to allow for appliance which may be installed at a later date.

If the propane load in standard cubic feet per hour (SCFH) is desired, divide the BTU/hr load by 2488 to get SCFH. Conversely, the BTU/hr capacity can be obtained from SCFH by multiplying the SCFH figure by 2488.

Figuring the total load accurately is most important because of the size of the pipe and tubing, the tank (or the number of cylinders) and the regulator will be based on the capacity of the system to be served.

Table 3. Gas Required For Common Appliances

APPLIANCE	APPROXIMATE INPUT BTU/HR
Warm Air Furnace Single Family Multifamily, per unit	100,000 60,000
Hydronic Boiler, Space Heating Single Family Multifamily, per unit	100,000 60,000
Hydronic Boiler, Space and Water Heating Single Family Multifamily, per unit	120,000 75,000
Range, Free Standing, Domestic Built-In Oven or Broiler Unit, Domestic Built-In top Unit, Domestic	65,000 25,000 40,000
Water Heater, Automatic Storage, 30 to 40 gal. Tank Water Heater, Automatic Storage, 50 gal. Tank Water Heater, Automatic Storage, Instantaneous 2 GPM 4 GPM 6 GPM Water Heater, Domestic, Circulating or Side-Arm	35,000 50,000 142,800 285,000 428,000 35,000
Refrigerator Clothes Dryer, Type 1 (Domestic) Gas Fireplace Direct Vent Gas Log Barbecue Gas Light Incinerator, Domestic	3000 35,000 40,000 80,000 40,000 2500 35,000

Table Reprinted From Table 5.4.2.1, NFPA 54, 2002 ed.

VAPORIZATION RATE

The rate of vaporization of a container is dependent upon the temperature of the liquid and the amount of “wetted surface” are of the container.

The temperature of the liquid is proportional to the outside air temperature and the wetted surface area in the tank surface are in contact with the liquid. Therefore, when the outside air temperature is lower or the container has less liquid in it, the vaporization rate of the container is a lower value.

To determine the proper size of ASME storage tanks or the proper number of DOT cylinders for various loads, it is important to consider the lowest winter temperature at the location.

Multiple cylinders or tanks may be manifolded to give the required vaporization capacity. Withdrawal of gas from one or two containers can lower the container pressure substantially due to the refrigeration of the vaporization gas. Regulator capacity is then reduced because of the lower inlet pressure. Where any reasonably heavy gas load is expected, put sufficient cylinders on each side of an automatic changeover system.

See pages 7 and 8 for more information.

VAPORIZATION RATES FOR ASME STORAGE TANKS

A number of assumptions were made in calculating the BTU figures listed in the Table 4 below:

- 1) The tank is one-half full.
- 2) Relative humidity is 70%.
- 3) The tank is under intermittent loading.

Although none of these conditions may apply, Table 4 can still serve as a good rule-of-thumb in estimating what a particular tank size will be provided under various temperatures. Continuous loading is not a very common occurrence on domestic installations, but under continuous loading, the withdrawal rates in Table 4 should be multiplied by 0.25.

Table 4. Maximum Intermittent Withdrawal Rate (BTU/hr) Without Tank Frosting* If Lowest Outdoor Temperature (Average For 24 Hours) Reaches...

TEMPERATURE		TANK SIZE, GALLONS / l			
		150 / 568	250 / 946	500 / 1893	1000 / 3785
40°F	4°C	214,900	288,100	478,800	852,800
30°F	-1°C	187,000	251,800	418,600	745,600
20°F	-7°C	161,800	216,800	360,400	641,900
10°F	-12°C	148,000	198,400	329,700	587,200
0°F	-18°C	134,700	180,600	300,100	534,500
-10°F	-23°C	132,400	177,400	294,800	525,400
-20°F	-29°C	108,800	145,800	242,300	431,600
-30°F	-34°C	107,100	143,500	238,600	425,000

* Tank frosting acts as an insulator, reducing the vaporization rate.

VAPORIZATION RATES FOR 100 LBS / 45 KG DOT CYLINDERS

“Rule of Thumb” Guide

For continuous draws, where temperatures may reach 0°F / -18°C, assume the vaporization rate of a 100 lbs / 45 kg cylinder to be approximately 50,000 BTU/hr. Therefore the:

Number of cylinders per side = total load in BTU/hr / 50,000

Example:

If a total requirement of 200,000 BTU/hr is to be supplied from 100 lbs / 45 kg DOT cylinders and winter temperatures may drop to 0°F / -18°C, then how many cylinders are needed per side?

Number of cylinders per side = 200,000 / 50,000 = 4

*When using a changeover regulator, 4 cylinders per side are required. Table 5 shows the vaporization rates for various temperatures and liquid levels in BTUH.

**Table 5. Vaporization Rates In BTUH
For Various Temperatures And Liquid Levels**

POUNDS OF PROPANE IN CYLINDER	-20°F / -29°C	0°F / -18°C	20°F / -6°C	40°F / 4°C
100	65,000	71,000	79,000	94,000
90	60,000	65,000	72,000	85,000
80	54,000	59,000	66,000	77,000
70	48,000	52,000	59,000	69,000
60	43,000	46,000	52,000	61,000
50	37,000	40,000	45,000	53,000
40	31,000	34,000	38,000	45,000
30	26,000	28,000	31,000	37,000
20	20,000	22,000	25,000	29,000
10	15,000	16,000	18,000	21,000

CYLINDER AND TANK MANIFOLDING

It is often necessary to manifold cylinders or tanks to obtain the required capacity needed for the installation. Multiple cylinder hookups are most frequently used in commercial applications and many residential jobs, even though tank manifolding is common in certain areas.

On certain multi-cylinder or tank installations, an automatic changeover regulator can be used. These regulators change from the supply cylinder (when the gas is exhausted) to the reserve cylinder automatically without having to shutdown the system to refill.

A typical cylinder manifold using an automatic changeover regulator can be installed in line with multiple cylinders (See Figure 1).

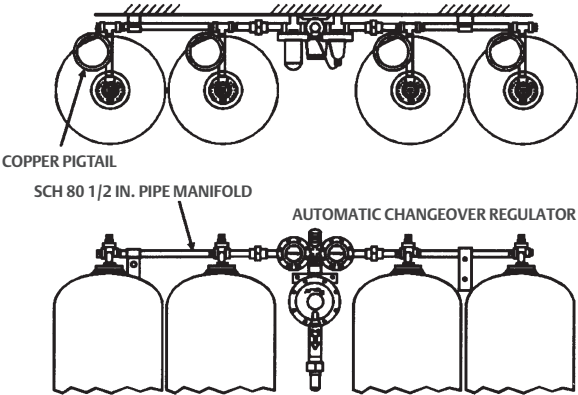

Figure 1. Cylinder Manifold with Automatic Changeover Regulator

CYLINDER AND TANK MANIFOLDING (continued)

When manifolding cylinders or tanks, do not use a regulator at each container. When this is done, the required capacity for the particular installation may not be obtained. It is impossible to set all of the regulators at the same outlet pressure. The regulator delivering the highest outlet pressure will backpressure the other regulators, keeping them from operating. In effect, only one container would be supplying gas in this sort of situation.

The answer on manifold installations is to run high pressure piping from the containers into a common line, as shown in Figure 2 below. Then, install a regulator that can handle the required capacity. Two-stage regulation is the most effective system on tank manifold installations.

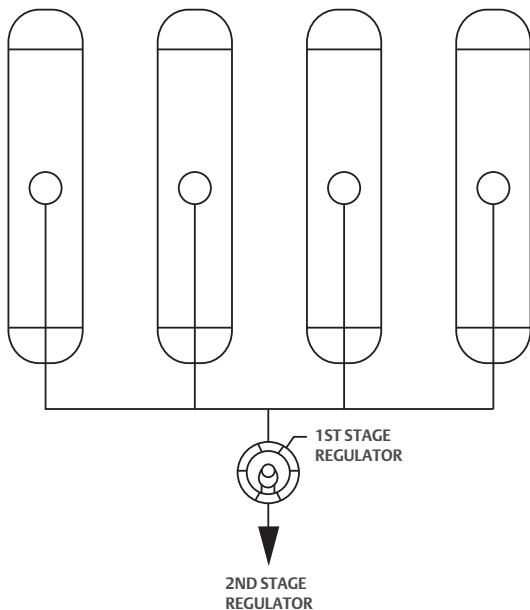

Figure 2. Schematic of a Tank Manifold Installation

CONTAINER LOCATION AND INSTALLATION

Once the proper size of ASME storage tank or the proper number of DOT cylinders has been determined, careful attention must be given to the most convenient, yet safe, place for their location on the customer's property.

Containers should be placed in a location pleasing to the customer that does not conflict with state and local regulations or NFPA Pamphlet No. 58, Storage and Handling of Liquefied Petroleum Gases. Refer to this standard to determine the appropriate placement of LP-Gas containers.

In general, storage tanks should be placed in an accessible location for filling, supported by concrete blocks of appropriate size and reinforcement and located away from vehicular traffic.

Cylinders should be placed with ease of replacement or refilling in mind, secured on a firm base and protected from vehicular traffic, animals and the elements.

For both ASME and DOT containers, the distance from any building openings, external sources of ignition and intakes to direct vented gas appliances or mechanical ventilation systems are a critical consideration. See Figures 3, 4 and 5 on pages 12, 13 and 14.

Refer to NFPA No. 58 for the minimum distances that these containers must be placed from the building or other objects.

CONTAINER LOCATION (continued)

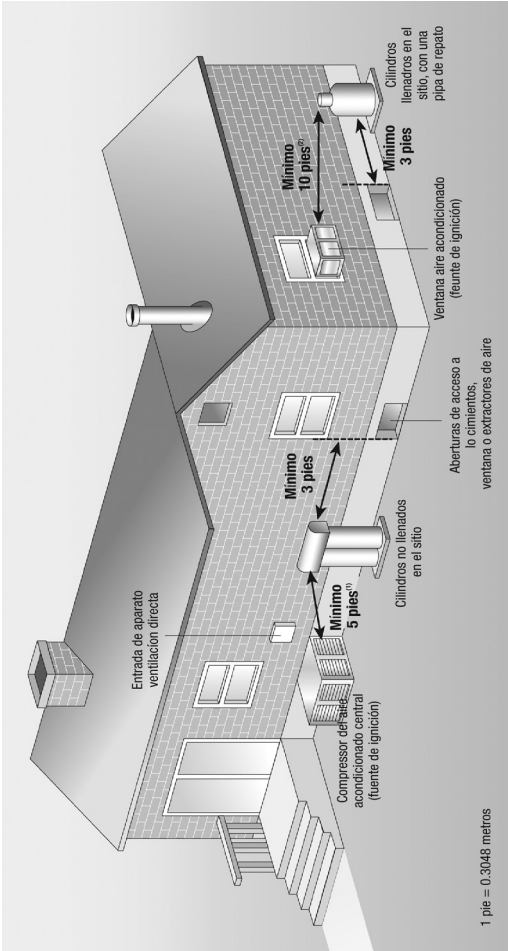

Note 1: 5 ft / 1.5 m minimum from relief valve in any direction away from any exterior source of ignition, openings into direct vent appliances or mechanical ventilation air intakes.

Note 2: If the cylinders are filled on site from a bulk truck, the filling connection and vent valve must be at least 10 ft / 3.0 m from any exterior source of ignition, openings into direct vent appliances or mechanical ventilation air intakes.

Figure 3. Cylinders, Reprinted from NFPA 58 Figure I.1(a), 2002 ed.

CONTAINER LOCATION (continued)

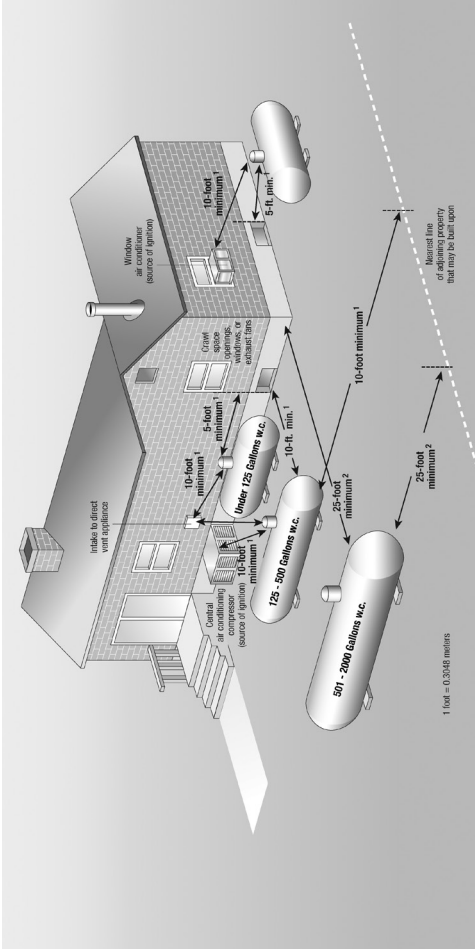

Note 2: The distance may be reduced to no less than 10 ft / 3.0 m for a single container of 1200 gal / 4.5 m³ water capacity or less provided such container is at least 25 ft / 7.6 m from any other LP-Gas container of more than 125-AF6126 gal / 0.5 m³ water capacity.

Note 1: Regardless of its size, any ASME tank filled on site must be located so that the filling connection and fixed liquid level gauge are at least 10 ft / 3.0 m away from any external source of ignition (i.e. open flame, window A/C, compressor, etc.), intake to direct vented gas appliances or intake to a mechanical ventilation system.

Figure 4. Above Ground ASME Containers, Reprinted from NFPA 58 Figure I.1(b), 2002 ed.

CONTAINER LOCATION (continued)

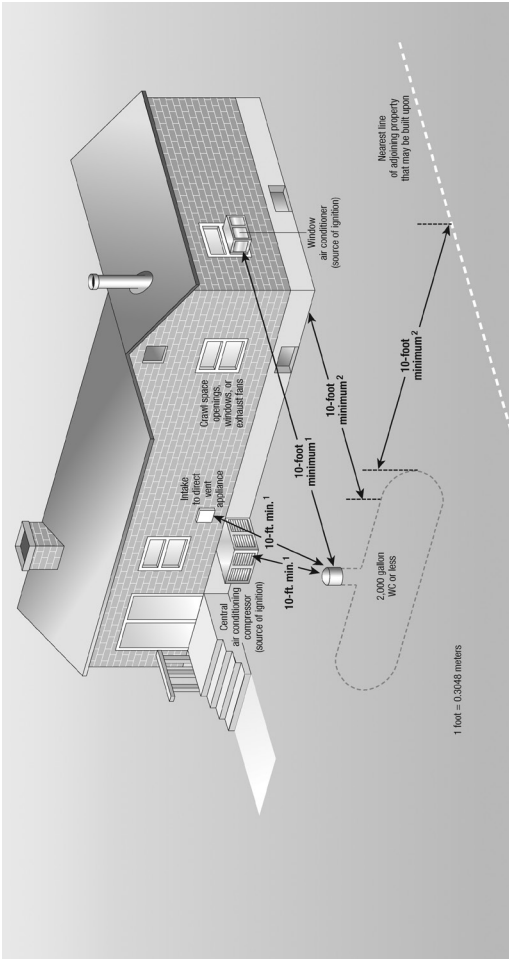

Note 1: The relief valve, filling connection and liquid fixed maximum level gauge vent connection at the container must be at least 10 ft / 3.0 m from any exterior source of ignition, openings into direct-vent appliances or mechanical ventilation air intakes.

Note 2: If the cylinder is filled on site from a bulk truck, the filling connection and vent valve must be at least 10 ft / 3.0 m from any exterior source of ignition, openings into direct-vent appliances or mechanical ventilation air intakes.

Figure 5. Below Ground ASME Containers, Reprinted from NFPA 58 Figure I.1(c), 2002 ed.

CONTAINER PREPARATION FOR REMOVAL OF WATER AND AIR CONTAMINANTS

Both water and air are contaminants that can seriously hinder the proper operation of the LP-Gas system and the connected appliances if not effectively removed. The following procedures will help increase system performance and decrease the number of service calls.

Removing Water from Containers

Water in LP-Gas cylinders and tanks can contaminate the gas, causing regulator freezeups and erratic appliance performance. Neutralize any moisture in the container by adding anhydrous methanol (99.85% pure) according to the amount shown in Table 6.

This will minimize freezeup problems for normal amounts of water in a container. However, this water may still cause corrosion or sediment problems. Large amounts of water should be drained from the tank.

Table 6. Methanol Requirements For Water Removal

CONTAINER SIZE	MINIMUM AMOUNT OF METHANOL REQUIRED
100 lbs Cylinder	1/8 Pint (2 Fluid Ounces)
150 gallons Tank	1 Pint
250 gallons Tank	1 Quart
500 gallons Tank	2 Quarts
1000 gallons Tank	1 Gallon

Warning: Do not substitute other alcohols in place of methanol.

PURGING AIR FROM CONTAINERS

Air in the LP-Gas can cause appliance pilot lights to be extinguished easily. It can also lead to excessive container pressure, making the safety relief valve open. Since nearly all containers are shipped from the fabricator under air pressure, it is extremely important to get rid of the air before the container is put in service.

DOT Cylinders

First, open the cylinder or service valves for several minutes to allow air to bleed to atmosphere. Then, pressure the cylinder with LP-Gas vapor and again open the cylinder or service valve (repeat this step at least two times).

ASME Storage Tanks

Depending on the type of valves in the tank, (see Figures 6a and 6b on page 17), purge the container as follows:

- 1) Bleed the air atmosphere by opening the multi-purpose valve or the service valve for several minutes until air pressure is exhausted. Close the valve.
- 2) If a pressure gauge has not been installed in the multi-purpose valve side outlet, install an appropriate pressure gauge. On tank with service valves, install a POL x 1/4 in. FNPT pipe coupling and an appropriate pressure gauge in the valve service valve outlet.
- 3) Attach the truck vapor equalizing hose to the multi-purpose valve's vapor equalizing valve to the separate vapor-equalizing valve.
- 4) Slowly open the shutoff valve on the end of the hose so that the truck excess flow check valve does not slam-shut.
- 5) Closely watch the pressure and when the gauge reaches 15 psig / 1.0 bar, close the shutoff valve.

PURGING AIR FROM CONTAINERS

ASME Storage Tanks (continued)

- 6) Open the vapor service valve on the multi-purpose valve (or the separate service valve, after removing the adaptor). Allow all pressure to be exhausted before closing the multi-purpose valve or the service valve.
- 7) Repeat steps 4 through 6 at least three more times to make certain air has been purged from the tank.

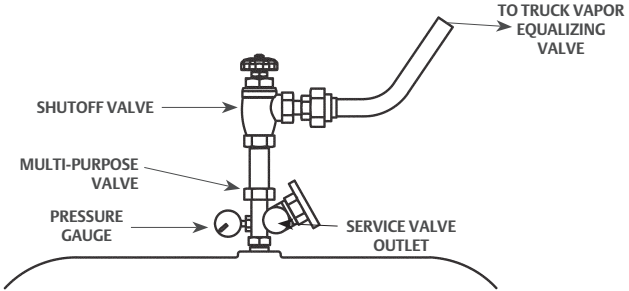
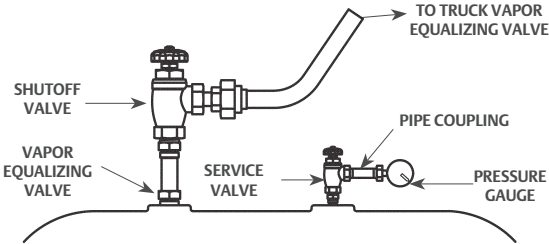

Figure 6a. Purging Method with Multi-Purpose Valve



Note: Do not purge tanks in this way on the customer’s property. Purge them in a safe place at the bulk plant site.

Figure 6b. Purging Method with Separate Valves

PIPE AND TUBING SIZING (CSST)

The proper selection of pipe and tubing sizes is essential for the efficient operation of the LP-Gas appliance. General consideration must be given to the maximum gas demand requirements of the system and the allowable pressure loss from the point of delivery to the inlet connection of the gas appliance.

Four different areas of sizing requirements must be addressed:

- 1) Sizing between First-Stage and Second-Stage Regulators
- 2) Sizing between Second-Stage Regulator and Appliance
- 3) Sizing between 2 psi / 0.14 bar Service and Line Pressure Regulators
- 4) Sizing between Line Pressure Regulator and Appliance

The following directions and examples, as well as Tables 7A through 8A starting on page 23, will assist in determining the proper selection of pipe and tubing sizing for these different areas. All data in the tables are calculated per NFPA Pamphlet Nos. 54 and 58.

PIPE AND TUBING SIZING (CSST) (continued)

Directions for Sizing between First-Stage and Second-Stage Regulators

(Based on NFPA 54 Hybrid Pressure Method)

- 1) Measure the required length of pipe or tubing from the outlet of the first-stage regulator to the inlet of the second stage regulator.
- 2) Determine the maximum gas demand requirements of the system by adding the BTU/hr inputs from the nameplates of all the appliances or by referring to Table 3 on page 5.
- 3) Select the pipe or tubing required from Tables 7A thru 7F on pages 23 through 28.

Directions for Sizing between Second-Stage Regulator and Appliance

(Based on NFPA 54 Longest Length Method)

- 1) Measure the length of pipe or tubing from the outlet of the second-stage regulator to the most remote appliance. (Note: This is the only length needed to size the second-stage system).
- 2) For each outlet and section of pipe, determine the specific gas demand requirements by adding the BTU/hr inputs from the nameplates of each appliance or by referring to Table 3 on page 5.
- 3) Select the pipe or tubing required for each section from Table 8A or 8B on pages 29 and 30.

PIPE AND TUBING SIZING

Determine the sizes of pipe or tubing required for this two-stage LP-Gas installation.

Example:

A private home is to be supplied with a LP-Gas system serving a central furnace, range and water heater. The gas demand and piping lengths are shown on the sketch below.

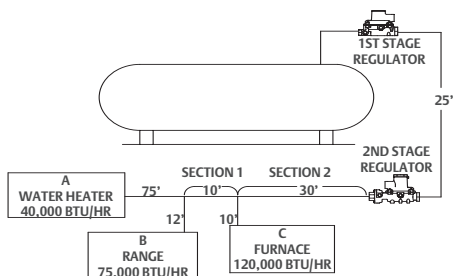

Figure 7. LP-Gas System Serving a Central Furnace, Range and Water Heater

For First-Stage:

- 1) Length of first-stage piping = 25 ft (round up to 30 foot for use in Tables 7A, 7B and 7C).
- 2) Total gas demand = 40,000 + 120,000 = 235,000 BTU/HR
- 3) From Tables 7A, 7B and 7C, use 1/2 in. CTS plastic pipe; or 1/4 in. Type L or 3/8 in. ACR copper tubing or 1/2 in. plastic tubing (assume a 10 psig / 0.7 bar first-stage regulator setting and a 1 psig pressure drop).

For Second-Stage:

- 1) Total second-stage piping length = 30 + 10 + 15 = 55 ft (round up to 60 foot for use in Tables 8A and 8B).
- 2) Gas demand requirements and pipe selection from Tables 8A and 8B (assume a 11 in. w.c. setting and 1/2 in. w.c. pressure drop).
For outlet A, demand = 40,000 BTU/hr, use 1/2 in. iron pipe or 3/8 in. Type L or 5/8 in. ACR copper tubing.
For outlet B, demand = 75,000 BTU/hr, use 1/2 in. iron pipe or 1/2 in. Type L or 5/8 in. ACR copper tubing.
For outlet C, demand = 120,000 BTU/hr, use 3/4 in. iron pipe or 5/8 in. Type L or 3/4 in. ACR copper tubing.
For section 1, demand = 40,000 + 75,000 = 115,000 BTU/hr, use 3/4 in. iron pipe or 5/8 in. Type L or 3/4 in. ACR copper tubing.
For section 2, demand = 40,000 + 75,000 + 120,000 = 235,000 BTU/hr, use 1 in. iron pipe.

PIPE AND TUBING SIZING (continued)

Directions for Sizing CSST between 2 psi / 0.14 bar Service Regulator and Line Pressure Regulator

- 1) Measure the length of CSST tubing from the outlet of the 2 psi / 0.14 bar service regulator to the inlet of the line pressure regulator.
- 2) Determine the maximum gas demand requirements of the system by adding the BTU/hr inputs from the nameplates of all the appliances or by referring to Table 3 on page 5.
- 3) Use the correct footage column or next higher column in Table 9A. Select CSST tubing size when capacity in column exceeds gas demand.

Directions for Sizing CSST between Line Pressure Regulator and Appliance

- 1) Measure the length of CSST tubing from the outlet of the line pressure regulator to each of the appliances.
- 2) For each outlet and selection of CSST tubing, determine the specific gas demand requirements by adding the BTU/hr inputs from the nameplates of each appliance or by referring Table 3 on page 5.
- 3) Use the correct footage column or the next higher column in Table 11. Select CSST tubing size when capacity in column exceeds gas demand.

Example:

A typical single family home with four appliances is to be supplied with a LP-Gas system. The piping is arranged in parallel with a distribution manifold branching CSST runs to the appliances. The supply pressure (downstream of the service regulator) is 2 psig / 0.14 bar and the outlet pressure of the line pressure regulator is set to 11 in. w.c. / 27 mbar. (See next page).

PIPE AND TUBING SIZING (continued)

Determine the sizes of pipe or tubing required for this in-house LP-Gas installation.

From 2 PSI Service Regulator to Line Regulator:

- 1) Length of section A tubing = 20 ft
- 2) Total gas demand = 80,000 + 36,000 + 28,000 + 52,000 = 196,000 BTU/hr
- 3) From Table 9A, use 25' column. Select 3/8 in. CSST for run A, as it has capacity over 196,000 BTU/hr (262,000) (assume a 2 psig / 0.14 bar second-stage regulator setting and 1 psig pressure drop).

From Line Pressure Regulator to Each Appliance:

- 1) For line B, length = 10 ft; gas demand = 80,000 BTU
For line C, length = 10 ft; gas demand = 36,000 BTU
For line D, length = 30 ft; gas demand = 28,000 BTU
For line E, length = 35 ft; gas demand = 52,000 BTU
- 2) CSST Tubing selection from Table 11 (assume a 11 in. w.c. setting and 1/2 in. w.c. pressure drop):

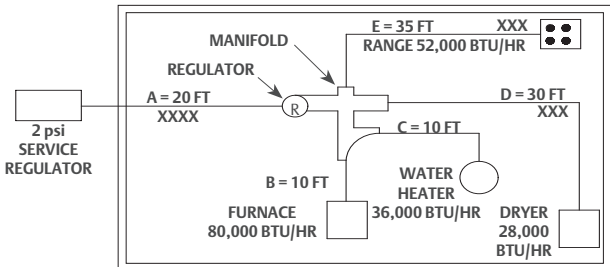

Figure 8. Single Family Home with a LP-Gas System

Single Family Home With LP-Gas Example

LINE	LENGTH (FT)	LOAD, 1000 BTU/HR	CSST CAPACITY, 1000 BTU/HR	SELECT CSST SIZE
B	10	80	129	1/2
C	10	36	50	3/8
D	30	28	28	3/8
E	35*	52	64	1/2

*Uses 40' column in Table 11.

Table 7A. Pipe Sizing Between First-Stage (High Pressure Regulator) And Second-Stage (Low Pressure Regulator)

MAXIMUM UNDILUTED PROPANE CAPACITIES BASED ON 10 psig FIRST STAGE SETTING AND 1 psig PRESSURE DROP. CAPACITIES ARE IN 1000 BTU PER HOUR.

Piping Length, Ft	Schedule 40 Pipe Size, In. (Actual Inside Diameter, In.)									
	1/2 NPT (0.622 In.)	3/4 NPT (0.824 In.)	1 NPT (1.049 In.)	1-1/4 NPT (1.38 In.)	1-1/2 NPT (1.61 In.)	2 NPT (2.067 In.)	3 NPT (3.068 In.)	3-1/2 NPT (3.548 In.)	4 NPT (4.026 In.)	
30	843	3854	7260	14,904	22,331	43,008	121,180	177,425	247,168	
40	1577	3298	6213	12,756	19,113	36,809	103,714	151,853	211,544	
50	1398	2923	5507	11,306	16,939	32,623	91,920	134,585	187,487	
60	1267	2649	4989	10,244	15,348	29,559	83,286	121,943	169,877	
70	1165	2437	4590	9424	14,120	27,194	76,622	112,186	156,285	
80	1084	2267	4270	8767	13,136	25,299	71,282	104,368	145,393	
90	1017	2127	4007	8226	12,325	23,737	66,882	97,925	136,417	
100	961	2009	3785	7770	11,642	22,422	63,176	92,499	128,859	
150	772	1613	3039	6240	9349	18,005	50,733	74,280	103,478	
200	660	1381	2601	5340	8002	15,410	43,421	63,574	88,564	
250	585	1224	2305	4733	7092	13,658	38,483	56,345	78,493	
300	530	1109	2089	5289	6426	12,375	34,868	51,052	71,120	
350	488	1020	1922	3945	5911	11,385	32,078	46,967	65,430	
400	454	949	1788	3670	5499	10,591	29,843	43,694	60,870	
450	426	890	1677	3444	5160	9938	28,000	40,997	57,112	
500	402	841	1584	3253	4874	9387	26,449	38,725	53,948	
600	364	762	1436	2948	4416	8505	23,965	35,088	48,880	
700	335	701	1321	2712	4063	7825	22,047	32,280	44,969	
800	312	652	1229	2523	3780	7279	20,511	30,031	41,835	
900	293	612	1153	2367	3546	6830	19,245	28,177	39,253	
1000	275	578	1089	2236	3350	6452	18,178	26,616	37,078	
1500	222	464	875	1795	2690	5181	14,598	21,373	29,775	
2000	190	397	748	1537	2302	4434	12,494	18,293	25,483	

Data taken and reprinted from Table 15.1(a) in NFPA 58, 2004 ed. Always check www.nfpa.org for the latest updates.

Table 7B. Pipe Sizing Between First-Stage (High Pressure Regulator) And Second-Stage (Low Pressure Regulator)

MAXIMUM UNDILUTED PROPANE CAPACITIES BASED ON 10 psig FIRST STAGE SETTING AND 1 psig PRESSURE DROP. CAPACITIES ARE IN 1000 BTU PER HOUR.

Type	ACR (Refrigeration)					Type L Tubing				
Nominal	3/8 in.	1/2 in.	5/8 in.	3/4 in.	7/8 in.	3/8 in.	1/2 in.	5/8 in.	3/4 in.	7/8 in.
Outside	(0.375)	(0.500)	(0.625)	(0.750)	(0.875)	(0.500)	(0.625)	(0.750)	(0.875)	(1.000)
Inside	0.311	0.436	0.555	0.68	0.785	0.430	0.545	0.666	0.785	0.906
Length, Ft										
30	299	726	1367	2329	3394	309	700	1303	2205	3394
40	256	621	1170	1993	2904	265	599	1115	1887	2904
50	227	551	1037	1766	2574	235	531	988	1672	2574
60	206	499	939	1600	2332	213	481	896	1515	2332
70	189	459	864	1472	2146	196	443	824	1394	2146
80	176	427	804	1370	1996	182	412	767	1297	1996
90	165	401	754	1285	1873	171	386	719	1217	1873
100	156	378	713	1214	1769	161	365	679	1149	1769
150	125	304	572	975	1421	130	293	546	923	1421
200	107	260	490	834	1216	111	251	467	790	1216
250	95	230	434	739	1078	90	222	414	700	1078
300	86	209	393	670	976	89	201	375	634	976
350	79	192	362	616	898	82	185	345	584	898
400	74	179	337	573	836	76	172	321	543	836
450	69	168	316	538	784	71	162	301	509	784
500	65	158	298	508	741	68	153	284	481	741
600	59	144	270	460	671	61	138	258	436	671
700	54	132	249	424	617	56	127	237	401	617
800	51	123	231	394	574	52	118	221	373	574
900	48	115	217	370	539	49	111	207	350	539
1000	54	109	205	349	509	46	105	195	331	509
1500	36	87	165	281	409	37	84	157	266	409
2000	31	75	141	240	350	32	72	134	227	350

Data taken and reprinted from Table 15.1(h) and 15.1(k) in NFPA 58, 2007 ed. Always check www.nfpa.org for the latest updates.

Table 7C. Polyethylene Plastic Tube And Pipe Sizing Between First-Stage And Second-Stage Regulators

MAXIMUM UNDILUTED PROPANE CAPACITIES BASED ON 10 psig FIRST STAGE SETTING AND 1 psig PRESSURE DROP. CAPACITIES ARE IN 1000 BTU PER HOUR.

Length of Pipe or Tubing, Ft.	Plastic Tubing Size (CTS) and Pipe Size (IPS) (Dimensions in Parenthesis are Inside Diameter)									
	1/2 In. CTS SDR 7.00 (0.445)	1 In. CTS SDR 11.00 (0.927)	1/2 In. IPS SDR 9.33 (0.660)	3/4 In. IPS SDR 11.00 (0.860)	1 In. IPS SDR 11.00 (1.077)	1-1/4 In. IPS SDR 10.00 (1.328)	2 In. IPS SDR 11.00 (1.943)			
30	762	5225	2143	4292	7744	13,416	36,402			
40	653	4472	1835	3673	6628	11,482	31,155			
50	578	3964	1626	3256	5874	10,176	27,612			
60	524	3591	1473	2950	5322	9,220	25,019			
70	482	3304	1355	2714	4896	8,483	23,017			
80	448	3074	1261	2525	4555	7,891	21,413			
90	421	2884	1183	2369	4274	7,404	20,091			
100	397	2724	1117	2238	4037	6,994	18,978			
125	352	2414	990	1983	3578	6,199	16,820			
150	319	2188	897	1797	3242	5,616	15,240			
175	294	2013	826	1653	2983	5,167	14,020			
200	273	1872	778	1539	2775	4,807	13,043			
225	256	1757	721	1443	2603	4,510	12,238			
250	242	1659	681	1363	2459	4,260	11,560			
275	230	1576	646	1294	2336	4,046	10,979			
300	219	1503	617	1235	2228	3,860	10,474			
350	202	1383	567	1136	2050	3,551	9,636			
400	188	1287	528	1057	1907	3,304	8,965			
450	176	1207	495	992	1789	3,100	8,411			
500	166	1140	468	937	1690	2,928	7,945			
600	151	1033	424	849	1531	2,653	7,199			
700	139	951	390	781	1409	2,441	6,623			
800	129	884	363	726	1311	2,271	6,161			
900	121	830	340	682	1230	2,131	5,781			
1000	114	784	322	644	1162	2,012	5,461			
1500	92	629	258	517	933	1,616	4,385			
2000	79	539	221	443	798	1,383	3,753			

Data taken and reprinted from Table 15.1(p) and 15.1(n) in NFPA 58, 2007 ed. Always check www.nfpa.org for the latest updates.

Table 7D. Pipe Sizing Between First-Stage (High Pressure Regulator) And Second-Stage (Low Pressure Regulator)

MAXIMUM UNDILUTED PROPANE CAPACITIES BASED ON 5 psig FIRST STAGE SETTING AND 1 psig PRESSURE DROP. CAPACITIES ARE IN 1000 BTU PER HOUR.

Piping Length, Ft	Schedule 40 Pipe Size, In. (Actual Inside Diameter, In.)									
	1/2 NPT (0.622 In.)	3/4 NPT (0.824 In.)	1 NPT (1.049 In.)	1-1/4 NPT (1.38 In.)	1-1/2 NPT (1.61 In.)	2 NPT (2.067 In.)	3 NPT (3.068 In.)	3-1/2 NPT (3.548 In.)	4 NPT (4.026 In.)	
30	514	2351	4429	9091	13,622	26,235	73,920	108,229	150,772	
40	962	2012	3790	7781	11,659	22,453	63,266	92,630	129,042	
50	853	1783	3359	6897	10,333	19,900	56,071	82,097	114,367	
60	773	1616	3043	6249	9362	18,031	50,804	74,385	103,625	
70	711	1487	2800	5749	8613	16,588	46,739	68,433	95,334	
80	661	1383	2605	5348	8013	15,432	43,482	63,664	88,690	
90	620	1297	2444	5018	7518	14,480	40,798	59,734	83,214	
100	586	1225	2309	4740	7102	13,677	38,537	56,424	78,604	
150	471	984	1854	3806	5703	10,983	30,947	45,311	63,122	
200	403	842	1587	3257	4881	9400	26,487	38,780	54,024	
250	357	747	1406	2887	4326	8331	23,475	34,370	47,881	
300	323	676	1274	3226	3920	7549	21,269	31,142	43,383	
350	298	622	1172	2406	3606	6945	19,568	28,650	39,912	
400	277	579	1091	2239	3354	6461	18,204	26,653	37,131	
450	260	543	1023	2101	3148	6062	17,080	25,008	34,838	
500	245	513	966	1984	2973	5726	16,134	23,622	32,908	
600	222	465	876	1798	2694	5188	14,619	21,404	29,817	
700	204	428	806	1654	2478	4773	13,449	19,691	27,431	
800	190	398	750	1539	2306	4440	12,512	18,319	25,519	
900	179	373	703	1444	2163	4166	11,739	17,188	23,944	
1000	168	353	664	1364	2044	3936	11,089	16,236	22,618	
1500	135	283	534	1095	1641	3160	8905	13,038	18,163	
2000	116	242	456	938	1404	2705	7621	11,159	15,545	

Data taken and reprinted from Table 15.1(a) in NFPA 58, 2004 ed. Always check www.nfpa.org for the latest updates.

Table 7E. Pipe Sizing Between First-Stage (High Pressure Regulator) And Second-Stage (Low Pressure Regulator)

MAXIMUM UNDILUTED PROPANE CAPACITIES BASED ON 5 psig FIRST STAGE SETTING AND 1 psig PRESSURE DROP. CAPACITIES ARE IN 1000 BTU PER HOUR.

Type	ACR (Refrigeration)					Type L Tubing				
Nominal	3/8 in.	1/2 in.	5/8 in.	3/4 in.	7/8 in.	3/8 in.	1/2 in.	5/8 in.	3/4 in.	7/8 in.
Outside	(0.375)	(0.500)	(0.625)	(0.750)	(0.875)	(0.500)	(0.625)	(0.750)	(0.875)	(1.000)
Inside	0.311	0.436	0.555	0.68	0.785	0.430	0.545	0.666	0.785	0.906
Length, Ft										
30	182	443	834	1421	2070	188	427	795	1345	2070
40	156	379	714	1216	1771	162	365	680	1151	1771
50	138	336	633	1077	1570	143	324	603	1020	1570
60	126	304	573	976	1423	130	293	547	924	1423
70	115	280	527	898	1309	120	270	503	850	1309
80	107	260	490	836	1218	111	251	468	791	1218
90	101	245	460	784	1143	104	235	439	742	1143
100	95	231	435	741	1079	98	223	414	701	1079
150	76	185	349	595	867	79	179	333	563	867
200	65	159	299	509	742	68	153	285	482	742
250	58	140	265	451	658	55	135	253	427	658
300	52	127	240	409	595	54	123	229	387	595
350	48	117	221	376	548	50	113	210	356	548
400	45	109	206	350	510	46	105	196	331	510
450	42	102	193	328	478	43	99	184	310	478
500	40	96	182	310	452	41	93	173	293	452
600	36	88	165	281	409	37	84	157	266	409
700	33	81	152	259	376	34	77	145	245	376
800	31	75	141	240	350	32	72	135	228	350
900	29	70	132	226	329	30	68	126	214	329
1000	33	66	125	213	310	28	64	119	202	310
1500	22	53	101	171	249	23	51	96	162	249
2000	19	46	86	146	214	20	44	82	138	214

Data taken and reprinted from Table 15.1(h) and 15.1(k) in NFPA 58, 2007 ed. Always check www.nfpa.org for the latest updates.

Table 7F. Polyethylene Plastic Tube And Pipe Sizing Between First-Stage And Second-Stage Regulators

MAXIMUM UNDILUTED PROPANE CAPACITIES BASED ON 5 psig FIRST STAGE SETTING AND 1 psi PRESSURE DROP. CAPACITIES ARE IN 1000 BTU PER HOUR.

Length of Pipe or Tubing, Ft.	Plastic Tubing Size (CTS) and Pipe Size (IPS) (Dimensions in Parenthesis are Inside Diameter)									
	1/2 In. CTS SDR 7.00 (0.445)	1 In. CTS SDR 11.00 (0.927)	1/2 In. IPS SDR 9.33 (0.660)	3/4 In. IPS SDR 11.00 (0.860)	1 In. IPS SDR 11.00 (1.077)	1-1/4 In. IPS SDR 10.00 (1.328)	2 In. IPS SDR 11.00 (1.943)			
30	465	3187	1307	2618	4724	8184	22,205			
40	398	2728	1119	2241	4043	7004	19,005			
50	353	2418	992	1986	3583	6207	16,843			
60	320	2191	899	1800	3246	5624	15,262			
70	294	2015	827	1656	2987	5175	14,040			
80	273	1875	769	1540	2779	4814	13,062			
90	257	1759	722	1445	2607	4516	12,256			
100	242	1662	681	1365	2463	4266	11,577			
125	215	1473	604	1210	2183	3781	10,260			
150	195	1335	547	1096	1978	3426	9296			
175	179	1228	504	1008	1820	3152	8552			
200	167	1142	475	939	1693	2932	7956			
225	156	1072	440	880	1588	2751	7465			
250	148	1012	415	831	1500	2599	7052			
275	140	961	394	789	1425	2468	6697			
300	134	917	376	753	1359	2355	6389			
350	123	844	346	693	1251	2166	5878			
400	115	785	322	645	1163	2015	5469			
450	107	736	302	605	1091	1891	5131			
500	101	695	285	572	1031	1786	4846			
600	92	630	259	518	934	1618	4391			
700	85	580	238	476	859	1489	4040			
800	79	539	221	443	800	1385	4124			
900	74	506	207	416	750	1300	3526			
1000	70	478	196	393	709	1227	3331			
1500	56	384	157	315	569	986	2675			
2000	48	329	135	270	487	844	2289			

Data taken and reprinted from Table 15.1(p) and 15.1(n) in NFPA 58, 2007 ed. Always check www.nfpa.org for the latest updates.

Table 8A. Pipe Sizing Between Second-Stage (Low Pressure Regulator) And Appliance

MAXIMUM UNDILUTED PROPANE CAPACITIES BASED ON 11 IN. W.C. SETTING AND 0.5 IN. W.C. PRESSURE DROP. CAPACITIES ARE IN 1000 BTU PER HOUR.

Piping Length, Ft	Schedule 40 Pipe Size, In. (Actual Inside Diameter, In.)									
	1/2 in. NPT (0.622 In.)	3/4 NPT (0.824 In.)	1 NPT (1.049 In.)	1-1/4 NPT (1.38 In.)	1-1/2 NPT (1.61 In.)	2 NPT (2.067 In.)	3 NPT (3.068 In.)	3-1/2 NPT (3.548 In.)	4 NPT (4.026 In.)	
10	291	608	1146	2352	3523	6789	19,130	28,008	39,018	
20	200	418	788	1617	2423	4666	13,148	19,250	26,817	
30	161	336	632	1299	1946	3747	10,558	15,458	21,535	
40	137	287	541	1111	1665	3207	9036	13,230	18,431	
50	122	255	480	985	1476	2842	8009	11,726	16,335	
60	110	231	435	892	1337	2575	7256	10,625	14,801	
80	94	198	372	764	1144	2204	6211	9093	12,668	
100	84	175	330	677	1014	1954	5504	8059	11,227	
125	74	155	292	600	899	1731	4878	7143	9950	
150	67	141	265	544	815	1569	4420	6472	9016	
200	58	120	227	465	697	1343	3783	5539	7716	
250	51	107	201	412	618	1190	3353	4909	6839	
300	46	97	182	373	560	1078	3038	4448	6196	
350	43	89	167	344	515	992	2795	4092	5701	
400	40	83	156	320	479	923	2600	3807	5303	

Data taken and reprinted from Table 15.1(c) in NFPA 58, 2007 ed. Always check www.nfpa.org for the latest updates.

Table 8B. Tube Sizing Between Second-Stage And Appliance

MAXIMUM UNDILUTED PROPANE CAPACITIES BASED ON 11 IN. W.C. SETTING AND 0.5 IN. W.C. PRESSURE DROP. CAPACITIES ARE IN 1,000 BTU PER HOUR.

Type	ACR (Refrigeration)								Type L Tubing					
	3/8 In.	1/2 In.	5/8 In.	3/4 In.	7/8 In.	3/8 In.	1/2 In.	5/8 In.	3/4 In.	7/8 In.	3/4 In.	5/8 In.	3/4 In.	7/8 In.
Nominal														
Outside	0.375	0.500	0.625	0.750	0.875	0.375	0.500	0.625	0.750	0.875	0.375	0.500	0.625	0.750
Inside	0.311	0.436	0.555	0.68	0.785	0.315	0.430	0.545	0.666	0.785	0.315	0.430	0.545	0.666
Length, Ft														
10	47	115	216	368	536	49	110	206	348	535	49	110	206	348
20	32	79	148	253	368	34	76	141	239	368	34	76	141	239
30	26	63	119	203	296	27	61	113	192	296	27	61	113	192
40	22	54	102	174	253	23	52	97	164	253	23	52	97	164
50	20	48	90	154	224	20	46	86	146	224	20	46	86	146
60	18	43	82	139	203	19	42	78	132	203	19	42	78	132
80	15	37	70	119	174	16	36	67	113	174	16	36	67	113
100	14	33	62	106	154	14	32	59	100	154	14	32	59	100
125	12	29	55	94	137	12	28	52	89	137	12	28	52	89
150	11	26	50	85	124	11	26	48	80	124	11	26	48	80
200	9	23	43	73	106	10	22	41	69	106	10	22	41	69
250	8	20	38	64	94	9	19	36	61	94	9	19	36	61
300	8	18	34	58	85	8	18	33	55	85	8	18	33	55
350	7	17	32	54	78	7	16	30	51	78	7	16	30	51
400	6	16	29	50	73	7	15	28	47	73	7	15	28	47

Data taken and reprinted from Table 15.1(i) and 15.1(j) in NFPA 58, 2007 ed. Always check www.nfpa.org for the latest updates.

Table 9A. Maximum Capacity Of CSST *

IN THOUSANDS OF BTU/HOUR OF UNDILUTED PROPANE AT A PRESSURE OF 2 PSI
AND A PRESSURE DROP OF 1 PSI (BASED ON A 1.5 SPECIFIC GRAVITY GAS).

CSST TUBE SIZE	EHD ** FLOW DESIGNATION	Tubing Length, Ft													
		10	25	30	40	50	75	80	100	150	200	250	300	400	500
3/8 in.	13	426	262	238	203	181	147	140	124	101	86	77	69	60	53
----	15	558	347	316	271	243	196	189	169	137	118	105	96	82	72
1/2 in.	18	927	591	540	469	420	344	333	298	245	213	191	173	151	135
----	19	1106	701	640	554	496	406	393	350	287	248	222	203	175	158
3/4 in.	23	1735	1120	1027	896	806	663	643	578	477	415	373	343	298	268
----	25	2168	1384	1266	1100	986	809	768	703	575	501	448	411	355	319
1 in.	30	4097	2560	2331	2012	1794	1457	1410	1256	1021	880	785	716	616	550
----	31	4720	2954	2692	2323	2072	1685	1629	1454	1182	1019	910	829	716	638
1-1/4 in.	37	7128	4564	4176	3631	3258	2675	2601	2325	1908	1658	1487	1363	1163	1027
1-1/2 in.	46	15,174	9549	8708	7529	6726	5480	5303	4738	3860	3337	2981	2719	2351	2101
2 in.	62	34,203	21,680	19,801	17,159	15,357	12,551	12,154	10,877	8890	7705	6895	6296	5457	4883

Table does not include effect of pressure drop across the line regulator. Where regulator loss exceeds 1/2 psi (based on 13 in. w.c. outlet pressure), do not use this table. Consult with regulator manufacturer for pressure drops and capacity factors. Pressure drops across a regulator may vary with flow rate. CAUTION: Capacities shown in table may exceed maximum capacity for a selected regulator. Consult with regulator or tubing manufacturer for guidance.

*Table includes losses for four 90-degree bends and two end fittings. Tubing runs with larger numbers of bend and/or fittings shall be increased by an equivalent length of tubing to the following equation: $L = 1.3n$ where L is the additional length (ft) of tubing and N is the number of additional fittings and/or bends.

**EDH - Equivalent Hydraulic Diameter - A measure of the relative hydraulic efficiency between different tubing sizes. The greater the value of EHD, the greater the gas capacity of the tubing. Data taken and reprinted from Table 15.1 (m) in NFPA 58, 2007 ed. Always check www.nfpa.org for the latest updates.

Table 9B. Pipe Sizing Between 2 PSI Regulator And Appliance Regulator

MAXIMUM UNDILUTED PROPANE CAPACITIES BASED ON 2 psi SETTING AND 1 psi PRESSURE DROP. CAPACITIES ARE IN 1000 BTU PER HOUR.

Piping Length, Ft	Schedule 40 Pipe Size, In. (Actual Inside Diameter, In.)									
	1/2 in. NPT (0.622 In.)	3/4 NPT (0.824 In.)	1 NPT (1.049 In.)	1-1/4 NPT (1.38 In.)	1-1/2 NPT (1.61 In.)	2 NPT (2.067 In.)	3 NPT (3.068 In.)	3-1/2 NPT (3.548 In.)	4 NPT (4.026 In.)	
10	2687	5619	10,585	21,731	32,560	62,708	176,687	258,696	360,385	
20	1847	3862	7275	14,936	22,378	43,099	121,436	177,800	247,690	
30	1483	3101	5842	11,994	17,971	34,610	97,517	142,780	198,904	
40	1269	2654	5000	10,265	15,381	29,621	83,462	122,201	170,236	
50	1125	2352	4431	9098	13,632	26,253	73,971	108,305	150,877	
60	1019	2131	4015	8243	12,351	23,787	67,023	98,132	136,706	
70	938	1961	3694	7584	11,363	21,884	61,660	90,280	125,767	
80	872	1824	3436	7055	10,571	20,359	57,363	83,988	117,002	
90	819	1712	3224	6620	9918	19,102	53,822	78,803	109,779	
100	773	1617	3046	6253	9369	18,043	50,840	74,437	103,697	
150	621	1298	2446	5021	7524	14,490	40,826	59,776	83,272	
200	531	1111	2093	4298	6439	12,401	34,942	51,160	71,270	

Data taken and reprinted from Table 15.1(b) in NFPA 58, 2007 ed. Always check www.nfpa.org for the latest updates.

Table 10. Tube Sizing Between Second-Stage And Appliance

MAXIMUM UNDILUTED PROPANE CAPACITIES BASED ON 2 psi SETTING AND 1 psi PRESSURE DROP. CAPACITIES ARE IN 1000 BTU PER HOUR.

Type	ACR (Refrigeration)							Type K Tubing				
	3/8 in.	1/2 in.	5/8 in.	3/4 in.	7/8 in.	3/8 in.	1/2 in.	5/8 in.	3/4 in.	7/8 in.		
Nominal	0.375	0.500	0.625	0.750	0.875	0.375	0.500	0.625	0.750	0.875		
Outside	0.311	0.436	0.555	0.68	0.785	0.315	0.430	0.545	0.666	0.785		
Length, Ft												
10	434	1053	1982	3377	4922	449	1015	1890	3198	4922		
20	298	723	1362	2321	3383	308	698	1299	2198	3383		
30	239	581	1094	1864	2716	248	560	1043	1765	2716		
40	205	497	936	1595	2325	212	479	893	1511	2325		
50	182	441	830	1414	2061	188	425	791	1339	2061		
60	165	399	752	1281	1867	170	385	717	1213	1867		
80	141	342	644	1096	1598	146	330	614	1038	1598		
100	125	303	570	972	1416	129	292	544	920	1416		
125	111	268	506	861	1255	114	259	482	816	1255		
150	100	243	458	780	1137	104	235	437	739	1137		
200	86	208	392	668	973	89	201	374	632	973		
250	76	184	347	592	863	79	178	331	560	863		
300	69	167	315	536	782	71	161	300	508	782		
350	63	154	290	493	719	66	148	276	467	719		
400	59	143	269	459	669	61	138	257	435	669		

Data calculated from Formula in NFPA 54, 2002 ed.

Table 11. Maximum Capacity Of CSST *

CSST TUBE SIZE	EHD** FLOW DESIGNATION	Tubing Length, Ft																
		5	10	15	20	25	30	40	50	60	70	80	90	100	150	200	250	300
3/8 in.	13	72	50	39	34	30	28	23	20	19	17	15	15	14	11	9	8	8
-----	15	99	69	55	49	42	39	33	30	26	25	23	22	20	15	14	12	11
1/2 in.	18	181	129	104	91	82	74	64	58	53	49	45	44	41	31	28	25	23
-----	19	211	150	121	106	94	87	74	66	60	57	52	50	47	36	33	30	26
3/4 in.	23	355	254	208	183	164	151	131	118	107	99	94	90	85	66	60	53	50
-----	25	426	303	248	216	192	177	153	137	126	117	109	102	98	75	69	61	57
1 in.	30	744	521	422	365	325	297	256	227	207	191	178	169	159	123	112	99	90
-----	31	863	605	490	425	379	344	297	265	241	222	208	197	186	143	129	117	107
1-1/4 in.	37	1415	971	775	661	583	528	449	397	359	330	307	286	270	217	183	163	147
1-1/2 in.	46	2830	1993	1623	1404	1254	1143	988	884	805	745	656	656	621	506	438	390	357
2 in.	62	6547	4638	3791	3285	2940	2684	2327	2082	1902	1761	1554	1554	1475	1205	1045	934	854

*Table includes losses for four 90° bends and two end fittings. Tubing runs with larger numbers of bend and/or fittings shall be increased by an equivalent length of tubing to the following equation:
 $L = 1.3n$ where L is the additional length (ft) of tubing and N is the number of additional fittings and/or bends.

**EDH - Equivalent Hydraulic Diameter - A measure of the relative hydraulic efficiency between different tubing sizes. The greater the value of EHD, the greater the gas capacity of the tubing.
 Data taken and reprinted from Table 15.1(n) in NFPA 58, 2007 ed. Always check www.nfpa.org for the latest updates.

SELECTING THE REGULATOR

Regulator performance curves show the capacity of a regulator at different inlet pressures, given the factory setting for outlet pressure.

Figure 9 shows a performance curve for a Fisher™ brand Second-Stage Regulator. Gas flow rate is plotted horizontally and regulator outlet pressure vertically. The curved line represents an inlet pressure of 10 psig / 0.69 bar. For the appliance to operate efficiently, the regulator outlet pressure must not fall below 9 in. w.c. / 22 mbar.

Emerson rates this particular regulator at the point the 10 psig / 0.69 bar inlet curve crosses the 9 in. w.c. / 22 mbar horizontal line. Thus, the literature would rate this regulator at 1,375,000 BTU/hr or more if the inlet pressure stays above 10 psig / 0.69 bar.

What you must know to select a regulator:

1. Appliance Load
2. Pipe Size
3. Inlet Pressure
4. Outlet Pressure
5. Gas Used (Propane/Butane)
6. Select From Manufacturer Catalog

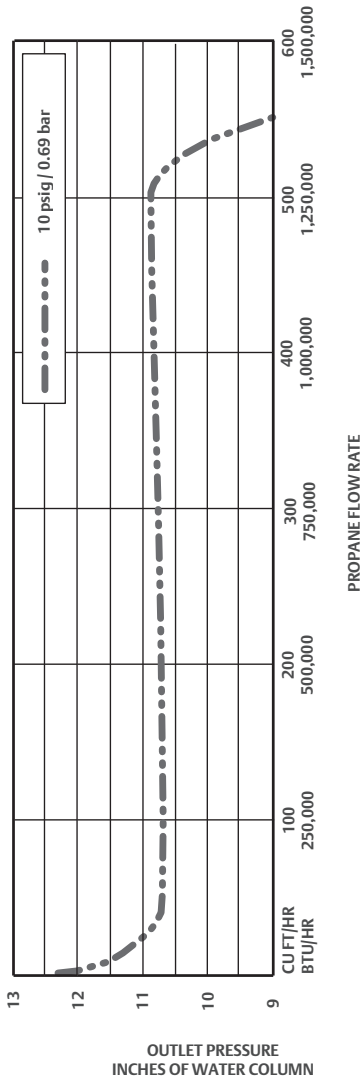

Figure 9. Typical Capacity Curve

REGULATOR SELECTION

TYPE OF REGULATOR OR SERVICE	CAPACITY, BTU/HR	RECOMMENDED FISHER™ REGULATOR
First-Stage⁽¹⁾ (Reduces tank pressure to 10 psig or less)	1,100,000 2,400,000	R122H R622H
Second-Stage⁽²⁾ (Reduces first stage outlet pressure to 14 in. w.c. or less)	650,000 875,000 to 1,400,000 920,000 1,000,000	R222 R622 R642 R652
Integral Two-Stage⁽¹⁾ (Combines a high pressure and a 2nd stage regulator)	450,000 850,000	R232 R632
High Pressure⁽³⁾ (Reduces tank pressure to a lower pressure in excess of 1 psig)	5,250,000 1,200,000 3,862,564	64 67C 1301F
2 psi⁽²⁾ Service (Reduces 1st stage pressure to 2 psig)	1,680,000 1,500,000	R622E R652E
1. Based on 30 psig inlet pressure and 20% droop. 2. Based on 10 psig inlet pressure and 20% droop 3. Based on inlet pressure 20 psig greater than outlet pressure with 20% droop.		

Note: The capacity BTU/hr column should be used for reference purposes only. The capacity will vary depending on the pipe size orifice size and outlet pressure setting.

TWO-STAGE REGULATION

Advantages of Two-Stage Regulation

Uniform Appliance Pressure - Two-staging lets the first-stage regulator supply a nearly constant inlet pressure to the second-stage regulator at the house. This means the second-stage regulator has an easier time of maintaining appliance pressure at 11 in. w.c. / 27 mbar, thus improving the system efficiency.

Lower Installation Costs - Smaller pipe or tubing can be used between the first and second-stage regulators due to the higher pressure, thus reducing installation and piping material costs.

Freezeups - Two-stage systems reduce problems due to regulator freezeups caused by excessive water in gas. Larger orifices make it more difficult for ice to form and block the passage area. The expansion of gas at two different orifices in a two-stage system greatly reduces the “refrigeration effect” that causes freezeups. See Fisher™ **Bulletins LP-18 and LP-24** for more detailed information on freezing regulators.

Flexibility of Installation - A high pressure regulator can feed a number of low pressure regulators, thus enabling the addition of appliances in the future to the same pressure line without affecting their individual performances.

Fewer Trouble Calls - With two-stage regulation, you can expect fewer trouble calls due to pilot outage or burner adjustment. This means higher appliance efficiency, lower service costs and better customer relations.

REGULATOR INSTALLATION

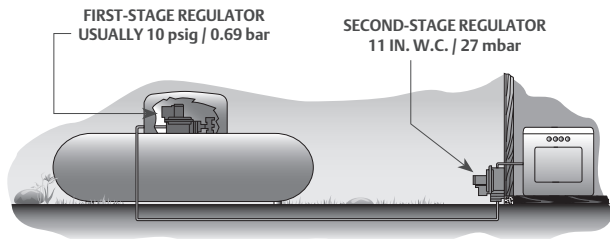

Figure 10. *Two-Stage Regulation, One at Tank and One at Building, Reduce Pressure Down to Burner Pressure (11 in. w.c. / 27 mbar)*

A two-stage regulator system or an integral two-stage regulator shall be required on all fixed piping systems that serve appliance systems at 11 in. w.c. / 27 mbar. This includes R.V., manufactured housing and food service installations (exceptions: small portable appliances and outdoor cooking appliances with input ratings of 100,000 BTU/hr or less, certain gas distribution systems utilizing multiple second-stage regulators and systems that provide an equivalent level of overpressure protection).

This standard along with changes in UL® 144 requiring increased regulator relief valve capacity or an overprotection shutoff device, results in the maximum pressure downstream of the second-stage regulator being limited to 2 psig / 0.14 bar even with a regulator seat failure.

See **Fisher™ Bulletin LP-15** for more detailed information on registration operation, installation and maintenance.

REGULATOR VENTS

Regulators should be installed in accordance with NFPA 58 and any other applicable regulations, as well as the manufacturer's instructions. The following guidelines shall be followed:

Outdoor Installations - A regulator installed outdoors without a protective hood must have its vent pointed vertically down, as shown in the drawing.

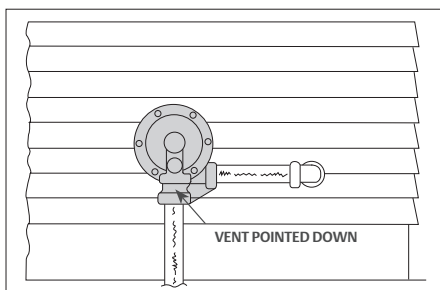

Figure 11. Vent Pointing Vertically Down

Regulators must be installed or protected so their operation will not be affected by the elements (freezing rain, sleet, snow, ice, mud or debris). All vent openings must be at least three horizontal feet in any building opening and not less than five feet in any direction from any source of ignition, openings into direct vent appliances or mechanical ventilation intakes.

Horizontally mounted regulators, such as on single cylinder installations, must be installed underneath a protective cover. On ASME tank installations with the regulator installed under the tank dome, the regulator vent should slope slightly down enough to allow any condensation to drain from the spring case. The regulator vent should be positioned far enough back from the tank dome slot so that it is protected from the weather. The hood should be kept closed.

Regulators without "drip lip" vents must be installed under a protective cover.

REGULATOR VENTS (continued)

Indoor Installations - In a fixed pipe system, regulators installed indoors require a vent line to the outside air. A screened vent assembly (Fisher™ brand Y602 Series or equivalent) must be used at the end of the vent line. The vent assembly position and location precautions are the same as for regulator vents. The vent line must be the same size as the regulator vent and adequately supported. See Figure 12.

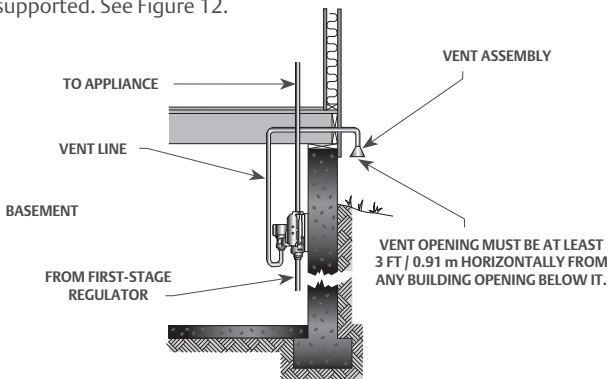

Figure 12. Indoor Installation

Underground Tanks - A vent tube is required on these installations to prevent water from entering the regulator's spring case. The vent tube connects to the regulator's spring case. The vent tube connects to the regulator vent and terminates above any possible water level, see Figure 13. Be sure that the ground slopes away from the tank dome as illustrated.

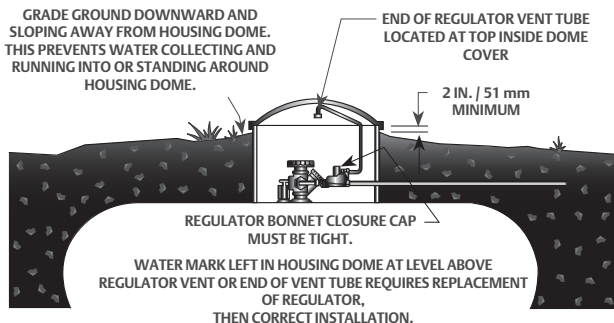

Figure 13. Underground Tank

LEAK TESTING METHODS

There are two primary methods for testing leaks in installations:

Low Pressure Method

- 1) Inspect all connections and appliance valves to be sure they are tight or closed. This includes pilot valves.
- 2) Connect a low pressure gauge (Fisher™ brand Type 50P-2 or equivalent) to the burner orifice and open the valve.
- 3) Open the service valve at the tank to pressure the system. Close the service valve tightly.
- 4) The low pressure gauge should read at least 11 in. w.c. / 27 mbar. Slowly bleed off pressure by opening burner valve on the appliance to vent enough gas to reduce the pressure to exactly 9 in. w.c. / 22 mbar.
- 5) If the pressure remains at 9 in. w.c. / 22 mbar for 3 minute you can assume the system is leak tight. If the pressure drops, refer to the leak detection procedures below.
- 6) After the leak is repaired, repeat steps 3, 4 and 5.

High Pressure Method

- 1) Inspect all connections and appliance valves to be sure they are tight or closed. This includes pilot valves.
- 2) Connect a test block (Fisher brand Type J600 or equivalent in the service valve outlet at the tank, between the valve's outlet and the first regulator in the system).
- 3) Open the service valve at the tank to pressure the system. Close the service valve tightly.
- 4) Open an appliance valve until the test block's pressure gauge drops to 10 psig / 0.69 bar.
- 5) The system should stand for 3 minutes without an increase or decrease in the 10 psig / 0.69 bar reading. If pressure drops, refer to the leak detection procedure section. If pressure increases, then the service valve is leaking.
- 6) After any leaks are repaired, repeat steps 2, 3 and 4.

LEAK TESTING METHODS (continued)

Leak Detection and Correction Procedures

- 1) Use a bubble leak detection solution, to mechanical leak detector, (never a match or an open flame) when checking for leaks.
- 2) Apply the solution over every pipe or tubing joint and observe carefully to see if the bubbles expand, indicating a leak is present. A large leak can blow the solution away before bubble have a chance to form.
- 3) To correct a leak on flaring tubing, first try to tighten the connection. If this does not work, reflare.
- 4) On threaded piping, try tightening or redoping first. If the leak continues, take the connection apart and inspect the threads. Cut new thread if necessary.
- 5) If steps 3 and 4 fail to correct the problem, look for sandholes in the pipe or fittings and check for splits in the tubing. Replace whatever material is defective.

Note: Leaks caused by equipment such as gas cocks, appliances, valves, act., will require repair of the faulty part or replacement of the entire device.

REGULATOR INSPECTION

The following items should be checked at each gas delivery and at regularly scheduled testing and maintenance program intervals.

The customer should be instructed to turn off the tank service valve if gas can be smelled, pilot lights fail to stay on or any other abnormal situation takes place.

Improper Installation

The regulator vent must be pointed down or under a protective cover. Regulators without “drip lip” vents (Figure 14) must be under a protective cover. Proper installation also minimizes weather related vent blockage and internal corrosion.

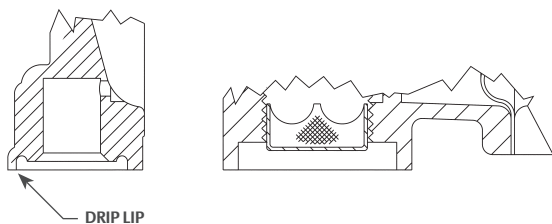

Figure 14. Drip Lip

Vent Blockage

Make sure the regulator vent, vent assembly or vent tube is not blocked with mud, insect nests, ice, snow, paint, etc. The screen should be clean and properly installed.

Internal and External Corrosion

Replace any regulator that has had water in the spring case or shows evidence of external or internal corrosion. Regulators that have been flooded or that have been installed horizontally, which minimizes moisture drainage, or on underground tanks or in coastal areas are more susceptible to internal corrosion.

To inspect for internal corrosion:

- 1) Remove the regulator's closing cap and look down into the spring case (a flashlight may be needed).
- 2) On some regulators it may be necessary to shut down the system and remove the adjusting screw and main spring to adequately see any internal corrosion.

REGULATOR INSPECTION

Internal and External Corrosion (continued)

- 3) Look for visible corrosion or water marks on the relief valve area and chimney (shaded area in the picture below).
- 4) Replace the regulator if corrosion is present.

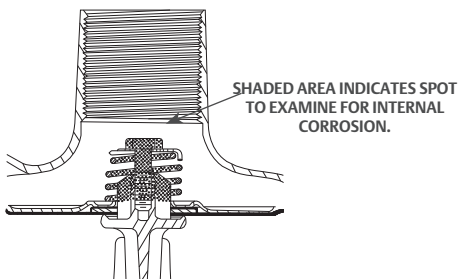

Figure 15. Corrosion Area

Regulator Age

Locate and replace old regulators. R600, R122H, R232, R222 and HSRL Series regulators have a recommended replacement life of 20 years. All other regulators have a recommended replacement life of 15 years. Replace regulators that are over the recommended replacement life or that have experienced conditions (corrosion, underground systems, flooding, etc.) that would shorten their service life. Older regulators are more likely to fail because of worn or corroded parts. Replace with a two-stage regulator system.

Regulator disk wear (especially on older regulators) or foreign material (dirt, pipe scale, etc.) lodged between the regulator disk and orifice can cause higher than normal outlet pressure to the appliances at lock up or extremely low flows. A pressure test of the system will be required to verify the outlet pressure under these conditions. Replace the regulator if pressure is high. Check the system for foreign material and clean out or replace pigtailed as needed.

Always reset the system after replacing a regulator. See **Fisher™ Bulletin LP-32** and the instruction manual for more detailed information on inspecting LP-Gas regulators.

TROUBLESHOOTING DOMESTIC TANK FITTINGS

A periodic inspection and maintenance program is recommended for domestic tank fittings. The following briefly discusses ways to avoid and correct potential safety problems with the most common domestic fittings.

A more complete examination of this subject can be found in NPGA Safety Bulletin 306.

Filler Valves

Always use a filling hose adaptor on the end of the hose end valve during the filling process. After filling the tank, do not disconnect the ACME coupling from the filler valve until the fill valve is closed and all pressure between the hose end valve and the fill valve has been bled off. If pressure discharge continues, the filler valve may have malfunctioned. Do not remove the fill hose as the internal parts may be blown out. If light tapping does not close the fill valve, disconnect the filling hose adaptor from the hose end valve, leaving the filling hose adaptor on the fill valve. The tank will probably have to be emptied to replace the fill valve.

Some fill valve designs allow the seat disk to be replaced while the tank is pressurized. On these designs, make sure the lower back check is still functioning by forcing open the upper back check with an adaptor. Take care to dislodge only the upper back check and not both back checks. If there is little leakage with the upper back check open, then the lower back check is in place and the disk can be replaced by following the manufacturer's instructions.

Relief Valves

Do not stand over a relief valve when tank pressure is high. A relief valve's purpose is to relieve excessive tank pressure which can be caused by overfilling, improper purging of air from the container, overheating of the tank, improper paint color or high vapor pressure, to list just a few reasons. Check the tank pressure gauge if the relief valve is leaking.

TROUBLESHOOTING DOMESTIC TANK FITTINGS

Relief Valves (continued)

On a 250 psi / 17.2 bar design pressure tank for example, if the relief valve is discharging between the 240 to 260 psig / 16.5 to 17.9 bar range, the relief valve is working properly as long as it reseats.

A relief valve that discharges substantially below 240 psig / 16.5 bar or that does not reseat when the tank pressure is lowered, will have to be replaced. Do not attempt to force the valve closed. Lower the tank pressure by withdrawing gas or cooling the outside of the tank.

Always keep a rain cap on the relief valve to help keep out dirt, debris and moisture.

Relief valves, like other pieces of equipment, will not last forever. Emerson recommends that a Fisher™ brand relief valves not be used for over 15 years. Earlier replacement may be required because of severe service conditions or applicable federal, state or local codes.

Liquid Withdrawal Valves

A damaged seat or missing internal parts may allow an excessive amount of liquid discharge when the closing cap is loosened. These valves have a bleed hole in the closing cap to vent liquid before the cap is completely unscrewed. If a significant amount of the liquid continues to vent from beneath the cap after 30 seconds, do not remove the cap. Should only vapor be leaking from under the cap, the connection to the withdrawal valve can usually be made.

There is the possibility of liquid spray while opening the withdrawal valve with an angle valve-special adaptor. For this reason, protective clothing should be worn and extreme care taken throughout the entire process.

Service Valves

Show the customer this valve and tell him to shut it off if gas is escaping into the house or any other abnormal situation takes place. Check the stem seal and shutoff seats periodically for leakage and replace them if necessary (empty the tank first).

**Table 12. LP-Gas Orifice Capacities LP-Gases
(BTU/hr at Sea Level)**

ORIFICE OR DRILL SIZE	PROPANE	BUTANE	ORIFICE OR DRILL SIZE	PROPANE	BUTANE
0.008	519	589	51	36,531	41,414
0.009	656	744	50	39,842	45,168
0.01	812	921	49	43,361	49,157
0.011	981	1112	48	46,983	53,263
0.012	1169	1326	47	50,088	56,783
80	1480	1678	46	53,296	60,420
79	1708	1936	45	54,641	61,944
78	2080	2358	44	602,229	68,280
77	2629	2980	43	64,369	72,973
76	3249	3684	42	71,095	80,599
75	2581	4059	41	74,924	84,940
74	4119	4669	40	78,029	88,459
73	4678	5303	39	80,513	91,215
72	5081	5760	38	83,721	94,912
71	5495	6230	37	87,860	99,605
70	6375	7227	36	92,207	104,532
69	6934	7860	35	98,312	111,454
68	7813	8858	34	100,175	113,566
67	8320	9433	33	103,797	117,672
66	8848	10,031	32	109,385	124,007
65	9955	11,286	31	117,043	132,689
64	10,535	11,943	30	134,119	152,046
63	11,125	12,612	29	150,366	170,466
62	11,735	13,304	28	160,301	181,728
61	12,367	14,020	27	168,580	191,114
60	13,008	14,747	26	175,617	199,092
59	13,660	15,846	25	181,619	205,896
58	14,333	16,249	24	187,828	212,935
57	15,026	17,035	23	192,796	218,567
56	17,572	19,921	22	200,350	227,131
55	21,939	24,872	21	205,525	232,997
54	24,630	27,922	20	210,699	238,863
53	28,769	32,615	19	223,945	253,880
52	32,805	37,190	18	233,466	264,673

Reprinted from Table F.2 in NFPA 54, 2002 ed. Always check www.nfpa.org for the latest updates.

	PROPANE	BUTANE
BTU per cubic foot	2516	3280
Specific Gravity	1.52	2.01
Pressure at Orifice, in. w.c.	11	11
Orifice Coefficient	0.9	0.9

Table 13. Line Sizing Chart For Liquid Propane In GPM

BASED ON 1 psig PRESSURE DROP, PROPANE AT 60°F. BASED ON SCHEDULE 40/80 STEEL/IRON PIPE

Piping Length, Ft	1/2 in.		3/4 in.		1 in.		1-1/4 in.		1-1/2 in.		2 in.		2-1/2 in.		3 in.		4 in.	
	40	80	40	80	40	80	40	80	40	80	40	80	40	80	40	80	40	80
10	7.1	5.0	15.0	11.3	28.3	22.2	58	47.6	87	73	169	143	269	229	475	410	967	846
15	5.8	4.1	12.2	9.2	23.0	18.1	47.5	38.8	71	59	137	116	219	187	387	334	789	690
20	5.0	3.5	10.5	8.0	19.9	15.6	41.0	33.5	62	51	119	100	189	161	335	289	682	597
30	4.1	2.9	8.5	6.5	16.2	12.7	33.4	27.3	50.1	41.6	97	82	154	131	283	235	556	486
40	3.5	2.5	7.4	5.6	14.0	11.0	28.8	23.5	43.3	35.9	84	71	133	114	236	203	481	421
50	3.1	2.2	6.6	5.0	12.5	9.8	25.7	21.0	36.3	32.1	75	63	119	101	211	182	429	376
60	2.8	2.0	6.0	4.5	11.3	8.9	23.4	19.1	35.2	29.2	68	57	109	92	192	166	391	343
70	2.6	1.8	5.5	4.2	10.5	8.2	21.6	17.7	32.5	27.0	63	53	100	85	177	153	362	317
80	2.4	1.7	5.2	3.9	9.8	7.7	20.2	16.5	30.4	25.2	59	49.6	94	80	166	143	338	296
90	2.3	1.6	4.8	3.7	9.2	7.2	19.0	15.5	28.6	23.7	55	46.7	88	75	156	135	319	279
100	2.2	1.5	4.6	3.5	8.7	6.8	18.0	14.7	27.1	22.5	52	44.2	84	71	148	128	302	264
150	1.8	1.2	3.7	2.8	7.1	5.5	14.6	11.9	22.0	18.2	42.5	35.9	68	58	120	104	246	215
200	1.5	1.1	3.2	2.4	6.1	4.8	12.6	10.3	18.9	15.7	36.7	31.0	59	49.9	104	89	212	185
300	1.2	0.9	2.6	1.9	4.9	3.8	10.2	8.3	15.3	12.7	29.7	25.1	47.5	40.4	84	73	172	151
400	1.0	0.7	2.2	1.7	4.2	3.8	8.8	7.1	13.2	10.9	25.6	21.6	40.9	34.8	73	66	149	130

CONVERSION FACTORS

Multiply	By	To Obtain
-----------------	-----------	------------------

LENGTH AND AREA

Millimeters	0.0394	Inches
Meters	3.2808	Feet
Sq. Centimeters	0.1550	Sq. Inches
Sq. Meters	10.764	Sq. Feet

VOLUME AND MASS

Cubic Meters	35.315	Cubic Feet
Liters	0.0353	Cubic Feet
Gallons	0.1337	Cubic Feet
Cubic cm.	0.061	Cubic Inches
Liters	2.114	Pints (US)
Liters	0.2642	Gallons (US)
Kilograms	2.2046	Pounds
Tonnes	1.1024	Tons (US)

PRESSURE AND FLOW RATE

Millibars	0.4018	Inches w.c.
Ounces/sq. in.	1.733	Inches w.c.
Inches w.c.	0.0361	Pounds/sq. in.
Bars	14.50	Pounds/sq. in.
Kilopascals	0.1450	Pounds/sq. in.
Kilograms/sq. cm.	14.222	Pounds/sq. in.
Pounds/sq. in.	0.068	Atmospheres
Liters/hr.	0.0353	Cubic Feet/hr.
Cubic Meters/hr.	4.403	Gallons/min.

MISCELLANEOUS

Kilojoules	0.9478	BTU
Calories, kg	3.968	BTU
Watts	3.414	BTU/HR
BTU	0.00001	Therms
Megajoules	0.00948	Therms

CONVERSION FACTORS

Multiply	By	To Obtain
LENGTH AND AREA		
Inches	25.4	Millimeters
Feet	0.3048	Meters
Sq. Inches	6.4516	Sq. Centimeters
Sq. Feet	0.0929	Sq. Meters
VOLUME AND MASS		
Cubic Feet	0.0283	Cubic Meters
Cubic Feet	28.316	Liters
Cubic Feet	7.481	Gallons
Cubic Inches	16.387	Cubic cm.
Pints (US)	0.473	Liters
Gallons (US)	3.785	Liters
Pounds	0.4535	Kilograms
Tons (US)	0.9071	Tonnes
PRESSURE AND FLOW RATE		
Inches w.c.	2.488	Millibars
Inches w.c.	0.577	Ounces/sq. in.
Pounds/sq. in.	27.71	Inches w.c.
Pounds/sq. in.	0.0689	Bars
Pounds/sq. in.	6.895	Kilopascals
Pounds/sq. in.	0.0703	Kilograms/sq. cm.
Atmospheres	14.696	Pounds/sq. in.
Cubic Feet/hr.	28.316	Liters/hr.
Gallons/min.	0.2271	Cubic Meters/hr.
MISCELLANEOUS		
BTU	1.055	Kilojoules
BTU	0.252	Calories, kg
BTU/HR	0.293	Watts
Therms	100,000	BTU
Therms	105.5	Megajoules

FLOW EQUIVALENTS AND TEMPERATURE CONVERSION

Table 14. Flow Equivalents

To convert flow capacities of one kind of gas to flow capacities of a different kind of gas

	MULTIPLY BY:	
If you have a flow capacity (CFH, etc.) in NATURAL GAS and want to know equivalent flow capacity of—	Propane:	0.63
	Butane:	0.55
	Air:	0.77
If you have BUTANE and want to know equivalent flow capacity of—	Propane:	1.15
	Natural Gas:	1.83
	Air:	1.42
If you have AIR and want to know equivalent flow capacity of—	Propane:	0.81
	Butane:	0.71
	Natural Gas:	1.29
If you have PROPANE and want to know equivalent flow capacity of—	Butane:	0.87
	Natural Gas:	1.59
	Air:	1.23

Table 15. Temperature Conversion

°F	°C	°F	°C	°F	°C
-40	-40	30	-1.1	90	32.2
-30	-34.4	32	0	100	37.8
-20	-28.9	40	4.4	110	43.3
-10	-23.3	50	10.0	120	48.9
0	-17.8	60	15.6	130	54.4
10	-12.2	70	21.1	140	60.0
20	-6.7	80	26.7	150	65.6

Serviceman's Handbook

LP-10



The contents of this publication are presented for informational purposes only, while every effort has been made to ensure their accuracy, they are not to be construed as warranties or guarantees, express or implied, regarding the products or services described herein or their use or applicability. We reserve the right to modify or improve the designs or specifications of such products at any time without notice.

LPG Equipment

Emerson Automation Solutions

Americas

T +1 800 558 5853

T +1 972 548 3574

 webadmin.regulators@emerson.com

 Fisher.com

Europe

T +39 051 419 0611

 Facebook.com/EmersonAutomationSolutions

Asia Pacific

T +65 6777 8211

 LinkedIn.com/company/emerson-automation-solutions

 Twitter.com/emr_automation

Middle East / Africa

T +971 4811 8100

