

Rosemount™ CT4400

Continuous Gas Analyzer



Preface

Published by Emerson.

All possible care has been taken in the preparation of this publication, but Emerson and its agents and distributors accept no liability for any inaccuracies that may be found. This manual reflects the state of the product at the issue date below, but further enhancements while in service may mean that the manual does not reflect your particular system.

Emerson reserves the right to make changes without notice both to this publication and the products which it describes.

Document number 00809-0100-4244 Rev AA, January 2020.

© Emerson 2020. All rights reserved.

No part of this publication may be reproduced, stored in a retrieval system, or transmitted in any form or by any means electronic, mechanical, photocopying, recording, or otherwise without the express prior written permission of the copyright holder.

If you require additional technical assistance, request help from cascade.support@emerson.com or Emerson distribution partners.

Send general inquiries to cascade.support@emerson.com.

All trademarks used within this document are the property of their respective owners.

Important instructions

Important

Users must read, understand and comply with the following information before proceeding.

All users, installers, operators, and maintainers must be familiar with operating the analyzer. To install, start up, operate, maintain and service the analyzer in a safe manner, it is **MANDATORY** to read all additional instruction manuals shipped with the analyzer. The following instruction manual(s) are available and/or referenced within this manual:

- Rosemount CT4400 Quick Start Guide

All instructions must be saved for future use. Contact your local service center or sales office if you are missing documents.

User information

Important

All users must read this page before proceeding!

Rosemount designs, manufactures, and tests its products to meet many national and international standards. The Rosemount CT4400 is a sophisticated technical product, and to ensure it continues to operate as designed and within normal specifications, it **MUST** be installed, used, and maintained correctly. The following instructions **MUST** be adhered to and integrated into your safety program when installing, using, and maintaining Rosemount products.

- Failure to follow the proper instructions may cause:
 - Loss of life.
 - Personal injury
 - Damage to property
 - Damage to the analyzer
 - Warranty invalidation
- Read all instructions prior to installing, operating, and servicing the analyzer.
- If you do not understand any of the instructions, contact your Rosemount Customer Care Representative for clarification.
- Follow all warnings, cautions, and instructions marked on and supplied with the analyzer.
- Inform and educate your personnel in the proper installation, operation, and maintenance of the analyzer.
- Install the analyzer as specified in the Installation Instructions of the manual and in accordance with all applicable local and national codes.
- Connect the analyzer to the proper electrical and pressure sources.
- To ensure proper performance, use qualified personnel to install, operate, update, program, and maintain the analyzer.
- When replacement parts are required, ensure that only qualified people install replacement parts specified by Rosemount.
- Unauthorized parts and procedures can affect the analyzer's performance, placing the safe operation of your process at risk, and **VOID YOUR WARRANTY**. Look-alike substitutions may result in fire, electrical hazards, or improper operation.

- To prevent electrical shock and personal injury, all equipment doors must be closed and protective covers in place, except when maintenance is being performed by qualified personnel.
- The information contained in this document is subject to change without notice.

General safety notice residual risk

Installation, operation, and maintenance of the analyzer must be in accordance with these instructions.

When operated as intended and all applicable safety instructions are observed, an element of risk will remain to the emission of gases hazardous to health when all gas connections have been made correctly.

To avoid exposure to the dangers, care must be taken when installing, operating, maintaining, and servicing the analyzer.

Authorized personnel

NOTICE

In-depth specialist knowledge is an absolute requirement for working with and on the analyzer. Personnel installing, operating, servicing, and maintaining the analyzer must be instructed, trained and qualified with the operating company and the manufacturer. It is the operating company's responsibility to:

- Train staff
- Observe safety regulations
- Follow the safety instructions and procedures in the product manual

Operators must:

- Be trained
- Read and understand all relevant sections of the product manual before commencing work
- Know the safety mechanisms and regulations

⚠ WARNING

To avoid explosions, loss of life, personal injury, and damage to this equipment and on-site property, do not install, operate, maintain, or service this analyzer before reading and understanding this instruction manual and receiving appropriate training.

Regulations and standards

Regulations / Standards	Description
2014/35/EU	The Low Voltage Directive
2014/30/EU	The Electromagnetic Compatibility Directive
2012/19/EU	Waste Electrical and Electronic Equipment (WEEE) Directive
USA 21 CFR 1040.1	Laser products - CFR - Code of Federal Regulations Title 21 part 1040.1
NEC® 505	National Electrical Code (issued by ANSI: American National Standards Institute and NFPA 70: National Fire Protection Association)
BS EN 61326-1: 2013 EN 61326-1: 2013	Electrical equipment for measurement, control, and laboratory use - EMC requirements. General requirements.
IEC/EN 60825-1: 2014	Safety of laser products part 1, equipment classification and requirements.
BS EN 61010-1 2010 IEC 61010-1 2010	Safety requirements for electrical equipment for measurements, control, and laboratory use. General requirements.
N/A	Electrical equipment for measurement, control, and laboratory use. EMC requirements. General requirements.

Associated publications

Quick Start Guide

Compliance approvals



This product complies with USA 21 CFR 1040.10. It is also designed and manufactured under an approved quality management system to ISO 9001:2015.

Emerson and the Rosemount CT4400 Gas Analyzer have satisfied the requirements for applying the CE marking to the Rosemount CT4400 Gas Analyzer.

This equipment meets all requirements of the EMC and Low Voltage directives.

Waste disposal



Do not dispose of measuring tools into household waste.

Only for EC countries:

In accordance with European Directive 2012/19/EU for Waste Electrical and Electronic Equipment and its implementation into national right, measuring tools that are no longer usable must be collected separately and disposed of in an environmentally correct manner.

Safety and information notices

⚠ DANGER

WILL CAUSE DEATH

Failure to follow this warning will result in death or serious injury to personnel.

⚠ WARNING

DANGER TO PERSONNEL

Failure to follow this warning may result in serious injury to personnel.

⚠ WARNING

SAFETY COMPLIANCE

Repairs or alterations are not permitted on any flame-proof paths, features, or joints.

Failure to follow this warning may compromise the product's safety protection method and void the product certification.

NOTICE

Important messages will appear in this format.

Safety information

All authorized users, including installation, operation, and maintenance personnel, **MUST** observe the following safety precautions and warnings.

⚠ DANGER

ELECTRIC SHOCK

The analyzer operates using mains voltage that is dangerous to life. Make sure that the power *ON/OFF* switch at the rear of the panel is set to *OFF* and the power cable plug is removed **BEFORE** removing the top cover.

THE ANALYZER **MUST BE EARTHED USING A GROUNDED THREE CORE CABLE** suitable for the rating defined in the General Characteristics ([Table 1-3](#)).

Failure to observe this precaution will cause death, personal injury, and/or damage to persons and/or property.

⚠ DANGER

FAILURE TO LOCK-OUT THE GAS HANDLING SYSTEM

Always lock out the gas handling system when shutting down the analyzer. Unauthorized operation of the gas handling system when maintenance is being performed on the analyzer or its associated pipes/hoses may result in highly flammable gas being released, causing fire or explosion.

Death or personal injury may result if this is not observed.

⚠ DANGER

FAILURE TO VENT SAMPLE GAS.

The sample gas in the system must be vented to prevent fire or explosion during maintenance and to prevent damage to the analyzer during startup.

The sample gas in the pipes leading to the analyzer must be purged to prevent hazards to personnel during maintenance. Purging the sample gas must be done in accordance with the safe working procedures for the site.

Allow the analyzer and system for returning the sample gas to run for five minutes to allow any sample gas in the system to be returned to the exhaust.

⚠ WARNING

LASER OPTICAL RADIATION EXPOSURE HAZARD

The Rosemount CT4400 is a Class 1 laser product. The lasers are fully enclosed so that no hazardous radiation is accessible under normal operating conditions.

Opening the analyzer and attempting to perform adjustments or procedures other than those specified in this manual may result in hazardous optical radiation exposure to personnel.

⚠ WARNING

HAZARDOUS SUBSTANCES

The analyzer may contain hazardous substances. Always handle the analyzer assemblies and components with extreme caution. Wear personal protective equipment (PPE) when handling the equipment.

Gas handling components within the analyzer contain particulate matter residue from the sample gases. Over the life of the analyzer, the concentration of particulate matter will become enriched within the gas handling components. When performing repairs and maintenance on the analyzer:

- Handle used gas handling components with extreme caution.
- Avoid direct skin contact with used gas handling components.
- Do not smoke, drink, or eat in the work area.
- Wear goggles or eye shields.
- Wear a suitable face mask to protect against inhalation of particulate matter.
- Do not wet fingers, eyes, or any exposed skin.
- Pack used gas handling components for disposal in sealed packaging and label them *Contaminated*.

Dispose of contaminated items as hazardous material in accordance with applicable local, national, or international health and safety regulations and pollution regulations.

⚠ WARNING

HAZARDOUS GAS

The product stream that the analyzer is examining may be hazardous even at low concentrations. Therefore, take special care to ensure that the sample gas return port either returns the sample gas to the product stream or discharges the sample gas to a location that will not cause a hazard.

⚠ WARNING

HIGH PRESSURE GAS AND AIR

The calibration gas supply operates at a pressure that can cause injury, e.g., damage to eyes and skin or punctures from debris blown by the high pressure gas or compressed air.

Always lock off or tag out the calibration gas supply when shutting down the analyzer.

⚠ WARNING

EXPLOSION HAZARD

Always lock-out/tag-out the gas handling system when shutting down the analyzer. Unauthorized operation of the gas handling system when maintenance is being performed on the analyzer or its associated pipes/hoses may result in highly flammable gas being released, causing fire or explosion.

Failure to observe this precaution will cause death, personal injury, and/or damage to persons.

⚠ WARNING

EXPLOSION HAZARD

The sample gas in the system must be vented to prevent fire or explosion during maintenance or during startup.

The sample gas in the pipes leading to the analyzer must be purged to prevent hazards to personnel during maintenance. Purging the sample gas must be done in accordance with the safe working procedures for the site.

Allow the analyzer and the venting system to run for a minimum of five minutes to allow any sample gas in the system to be returned to the exhaust.

⚠ WARNING

HEAVY ITEM

Handle the analyzer with caution during unpacking, installing, maintaining, and transporting to prevent crushing of hands, feet, or other body parts.

The analyzer weighs 33 lb (15 kg) for the half rack system and 66 lb (30 kg) for the full rack system. Rosemount recommends that the analyzer is moved by a minimum of two people when lifting and transporting the equipment.

Failure to properly handle the analyzer may cause injury to personnel, wear suitable protective gloves and protective footwear.

⚠ WARNING

PHYSICAL ACCESS

Unauthorized personnel may potentially cause significant damage to and/or misconfiguration of end users' equipment. This could be intentional or unintentional and needs to be protected against.

Physical security is an important part of any security program and fundamental to protecting your system. Restrict physical access by unauthorized personnel to protect end users' assets. This is true for all systems used within the facility.

⚠ CAUTION

EQUIPMENT DAMAGE

Always follow the start-up procedure. Damage to the analyzer may result from a failure to follow this procedure.

⚠ CAUTION

EQUIPMENT DAMAGE

Always follow the shutdown procedure. Damage to the analyzer may result from a failure to follow this procedure.

⚠ CAUTION

UNSERVICEABLE EQUIPMENT

If the pressure and temperature measurements are out of tolerance, refer to [Troubleshooting and diagnostics](#) for guidance.

⚠ CAUTION

EMC

This is a Class A product. In a domestic environment, this product may cause radio interference, in which case the user may be required to take adequate measures.

⚠ CAUTION

EQUIPMENT DAMAGE

Ensure that the local power voltage where the unit is to be installed corresponds to the unit's nominal voltage as given on the name plate label.

⚠ CAUTION

EQUIPMENT DAMAGE



Do not power up or try to operate the analyzer unless it is physically secure and all electrical and pneumatic connections to the analyzer are in place.



Before commencing the start-up process, it is important to ensure that electrical power, sample gas handling facilities, and any calibration gases that are required are available to the analyzer.

Safety and system labels and annotation

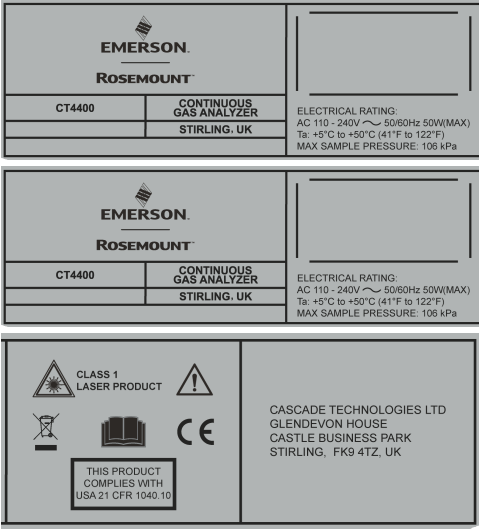
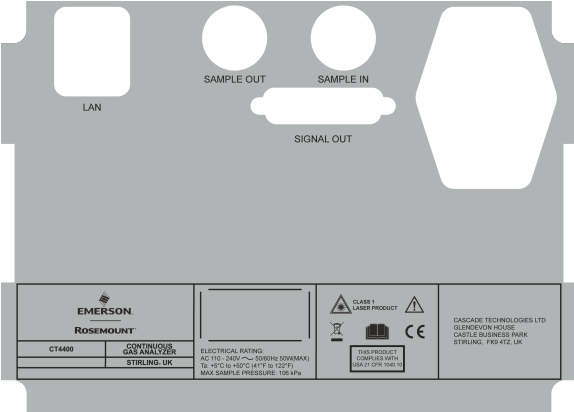
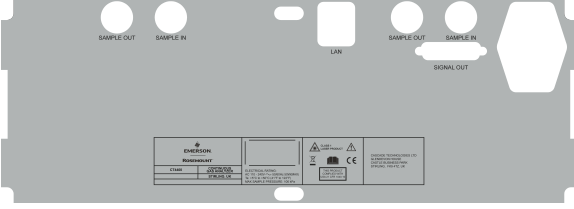
Safety Labels

The labels and annotation applied to the analyzer are specified in the table.

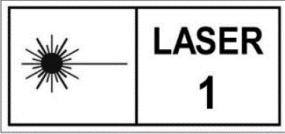
Label type	Example	Location
<p>Identification label (including the Serial No. (S/N) Model, Config No. and Date of Manufacture (DoM).</p>		<p>Fitted on the rear panel</p>
<p>Identification ratings label for the Half Rack System.</p>		<p>Fitted on the rear panel of the unit</p>
<p>Identification ratings label for the Full Rack System.</p>		<p>Fitted on the rear panel of the unit</p>
<p>Earth identification label.</p>		<p>Backplate</p>

Label type	Example	Location
CAUTION Laser Radiation safety statement		Rear panel
AC power supply voltage label	 	Fitted on inside rear panel next to power input socket.

Abbreviations

The following [symbols and abbreviations](#) are used in this manual.

Abbreviation	Description
©	Copyright
%	Percent
°	Degree
AC	Alternating current
BS	British Standard
C	Celsius
CE	European Conformity
CFR	Code of Federal Regulations
e.g.	For example
EC	European Community
EMC	Electromagnetic compatibility
EU	European Union
Hz	Hertz
H ₂ O	Water
IEC	International Electro-technical Commission
in.	Inches
IP	Internet Protocol
ISO	International Organization for Standardization
k	Thousand
kg	Kilogram
L	Liter
lb.	Pounds
LCD	Liquid crystal display
m	Meter
mA	Milliamp

Abbreviation	Description
Max	Maximum
mg	Milligram
mg/m ³	Milligram/cubicmeter
Mid IR	Mid Infrared
Min	Minimum
mm	Millimeter
NEC	National Electrical Code
NFPA	National Fire Protection Association
NH ³	Ammonia
nm	Nanometer
NO	Nitricoxide
N ₂ O	Nitrousoxide
No.	Number
O ₂	Oxygen
PC	Personal computer
ppm	Parts per million
QCL	Quantum Cascade Laser
SELV	Safety Extra Low Voltage (SELV) circuits.
Torr	Unit of pressure defined as exactly 1/760 of a standard atmosphere
USA	United States of America
USB	Universal serial bus
V	Volt
Vac	Volt alternating current
Vdc	Volt direct current
W	Watt
WEEE	Waste electrical and electronic equipment
μm	Micro-meter

Contents

Chapter 1	Plan.....	13
	1.1 Description.....	13
	1.2 Equipment purpose and role.....	13
	1.3 System overview.....	15
	1.4 Customer information.....	16
	1.5 Safety precautions and conditions for safe use.....	17
	1.6 Qualified personnel.....	17
	1.7 Software version.....	17
	1.8 Detailed system specifications.....	18
	1.9 Unpacking the analyzer.....	21
Chapter 2	Install.....	23
	2.1 Site selection and rack mounting.....	23
	2.2 Gas inputs and outputs.....	25
	2.3 Connecting the electrical/electronic inputs and outputs.....	26
Chapter 3	Start-up procedure.....	29
	3.1 Introduction.....	29
	3.2 Preparation for use.....	29
	3.3 Start-up procedure.....	30
Chapter 4	Operating the analyzer.....	33
	4.1 Introduction.....	33
	4.2 Normal operation.....	33
	4.3 Display controller.....	35
	4.4 Gas sensor main screen.....	36
	4.5 Pressure and temperature screen.....	37
	4.6 Help system.....	38
	4.7 Main menu.....	38
	4.8 BACK button.....	39
Chapter 5	Verifying gas concentrations.....	41
	5.1 Verification.....	41
Chapter 6	Gas calibration.....	49
	6.1 Required tools.....	49
	6.2 Gas service menu definitions.....	49
	6.3 Calibration.....	50
	6.4 Reference gas - suggested concentration ranges.....	63
Chapter 7	Troubleshooting and diagnostics.....	65
	7.1 Troubleshooting, repairs, and failure diagnostics.....	65

	7.2 Using the Built-In-Self Test (BIST) fault diagnostics.....	67
	7.3 Configuring the 4-20mA outputs.....	73
	7.4 Visual examination.....	78
	7.5 Failure diagnostics.....	78
	7.6 Replacing the power socket fuses.....	83
	7.7 Cleaning the analysis cell mirrors.....	85
Chapter 8	Shutdown procedure.....	91
Chapter 9	Preventative maintenance.....	97
Chapter 10	Recommended spare parts.....	99
Appendix A	Engineering drawings.....	101

1 Plan

1.1 Description

The Rosemount CT4400 Continuous Gas Analyzer, referred to hereafter as Rosemount CT4400 is a multi-component Quantum Cascade™ Laser (QCL)/Tuned Diode Laser (TDL) analyzer designed for applications where processing gas streams is required.

Optimized for cold/dry applications running at ambient pressure with low maintenance, low cost of ownership, and easy integration, it can hold up to five laser modules and measure up to six components simultaneously with enhanced dynamic range from sub parts per million (sub ppm) to percentage levels in a process gas stream.

The analyzer is designed to be mounted in a standard 19 in. (482.6 mm) rack width as either a half rack or full rack system depending on the gas analysis configuration required.

⚠ WARNING

HEAVY ITEM

Handle the analyzer with caution during unpacking, installing, maintaining, and transporting to prevent crushing of hands, feet, or other body parts.

The analyzer weighs 33 lb (15 kg) for the half rack system and 66 lb (30 kg) for the full rack system. Rosemount recommends that the analyzer is moved by a minimum of two people when lifting and transporting the equipment.

Failure to properly handle the analyzer may cause injury to personnel, wear suitable protective gloves and protective footwear.

1.2 Equipment purpose and role

The analyzer is a multi-component QCL/TDL gas analysis system that can be configured to measure concentrations of multiple small molecules in a gas sample that is provided to the analyzer through a customer installed gas sample line.

The types of molecules that are measured depend on the system configuration.

Figure 1-1: Rosemount CT4400 Half Rack System



Figure 1-2: Rosemount CT4400 Full Rack System

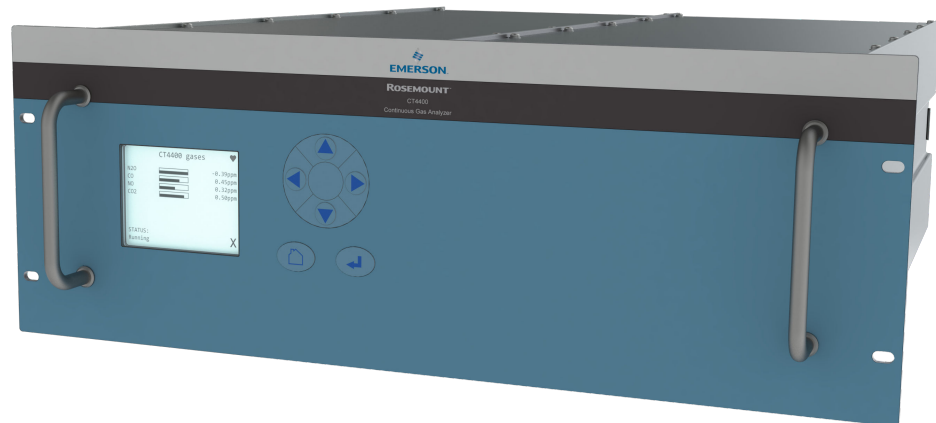

The analyzer can be configured to detect and measure up to six different gases simultaneously.

1.3 System overview

A complete Rosemount CT4400 system consists of the analyzer, and the associated interconnecting wiring and gas piping.

Measurement data from the analyzer can be displayed in the process control center. You must provide a stable gas handling system and interconnecting wiring and gas piping; Rosemount will supply the analyzer.

In [Figure 1-3](#), the items supplied by Rosemount are colored orange; the items supplied by the Customer are colored blue. [Table 1-1](#) lists the main items of the system.

Figure 1-3: Complete Rosemount CT4400 Gas Analysis System

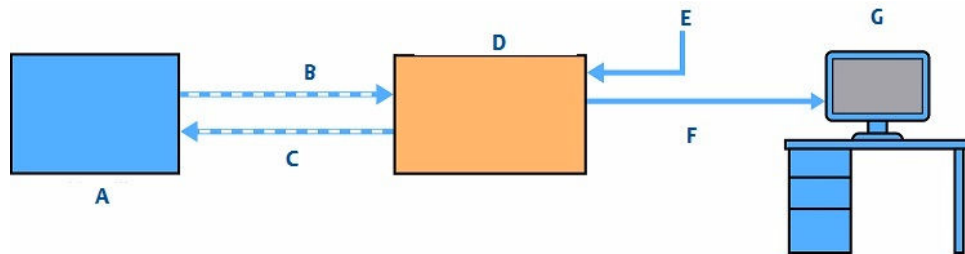

- A. Gas handling system
- B. Sample supply line
- C. Sample return (exhaust) line
- D. Rosemount CT4400 Gas Analyzer
- E. Electrical power
- F. Measurement data
- G. Control center

The analyzer contains an optical system with a laser, components that provide an optical path, sample inlet/outlet ports that can be connected to a customer provided gas handling system and control/analysis electronics. The complete system operates from either a 110 Vac 60Hz or a 230 Vac 50Hz supply.

Gas concentrations are measured using mid-infrared optical absorption spectroscopy. The light source is provided by a quantum cascade laser or tuned diode laser, which produces wavelength sweeps that cover the absorption lines of the gases. The light from the laser is routed through an optical path to the analysis cell, which provides measurement of low concentrations of the sample gas. An external sample handling system conditions the sample gas and draws it through the analysis cell. The laser light exiting the multi-pass analysis cell is directed to a receiver in the analyzer. The variation in the intensity of the light in the vicinity of the absorption lines is measured, and the concentration is determined using a spectral fitting routine.

There is no sample conditioning provided within the analyzer; this is the responsibility of the Customer. The sample gas must be conditioned as detailed in [Sample gas conditioning requirements](#) before entering the analyzer. Detailed characteristics of the analyzer are given in [Detailed system specifications](#).

Table 1-1: Main Items of the Rosemount CT4400 System

Item	Name or description	Supplied by	Part number	Quantity	Notes
1	Rosemount CT4400	Rosemount	CT4400	1	N/A
2	Rosemount CT4400 software package, version 5.7.8.0 minimum	Rosemount	N/A	1	Software is embedded on the PC board. Version described in the manual
3	Gas handling system	Customer	Customer choice	1	Selected to provide steady state conditions
4	Exhaust line hose (for sample gas)	Customer	Customer choice	1	N/A
5	Reference gas cylinders (instrument gas) for calibration purposes	Customer	Customer choice	Dependent upon number of gases being measured	N/A
6	Pressure regulator	Customer	Customer choice	1 per gas cylinder	Required for calibration
7	Pneumatic T-piece	Customer	Customer choice	2	Required for calibration
8	Excess flow line	Customer	Customer choice	1	Required for calibration
9	110/230 Vac power cable	Rosemount	Customer choice	1	3 core cable MUST be earthed
10	Cable from analyzer to control center	Customer	Customer choice	1	N/A
11	482.6 mm (19 in.) rack system	Customer	Customer choice	1	Holds the Rosemount CT4400

1.4 Customer information

This manual contains all the important information that must be followed to ensure the correct operation and safety of personnel when operating the analyzer.

For information regarding installation, consult [Install](#) and the Quick Start Guide.

Emerson is committed to continuously improving its products and documentation. Every effort will be made to include in the documentation any modifications by the manufacturer. However, this document reflects the supplied analyzer at the revision date on the front cover.

Should you require further information, or should particular problems arise that are not covered in this manual, you can request additional help from Cascade Technical Support (cascade.support@emerson.com) or Emerson distribution partners. Further contact details for Emerson can be found on the back page of this manual.

1.5 Safety precautions and conditions for safe use

⚠ WARNING

Before installing or performing any maintenance on the analyzer, read and understand the safety information given in the preliminary information of this manual.

The analyzer described in this manual has been quality control tested and left the manufacturer in pristine condition. To achieve the correct and safe operation of this product, it must be transported, installed, operated, and maintained as described by the manufacturer.

All lasers used within the analyzer are Class 1. The lasers are fully enclosed so that no hazardous radiation is accessible under normal operating conditions. Opening the analyzer and attempting to perform adjustments or procedures other than those specified in this manual may result in hazardous optical radiation exposure to personnel.

The analyzer has warning labels at appropriate positions in accordance with USA 21 CFR 1040.10.

1.6 Qualified personnel

This manual provides installation, operation, and maintenance personnel with the level of knowledge required to safely start, operate, and switch off the analyzer.

Only technically qualified personnel in the field of analysis and control who are familiar with this manual and have been specially trained on the analyzer should install, operate, switch off, and service the analyzer. Only qualified and trained persons have the required specific knowledge to correctly interpret the general safety information, warnings, and procedures given in this manual and apply them to this particular application. Emerson or its distribution partners can provide this training on request.

Knowledge of the safety information within this manual and its technically correct implementation are prerequisites for danger-free installation, operation, and maintenance of the analyzer.

1.7 Software version

The analyzer includes software that is used to control the operation of the analyzer. This manual describes the software version as: 5.7.8.0 minimum.

1.8 Detailed system specifications

Table 1-2 gives the physical characteristics of the analyzer. Schematic diagrams of the analyzers are shown in Figure 1-4 and Figure 1-5 with mounting points in Figure 2-1 and Figure 2-2. General and environmental characteristics for the analyzer are provided in Table 1-3 and Table 1-4.

Table 1-2: Physical Characteristics

Rosemount™ CT4400	Value	Units	Comment
External dimensions (Half Rack)	623 x 215 x 172 24.5 x 8.5 x 6.8	mm in.	Length x width x height Nominal dimensions
Weight (Half Rack)	15 33	kg lb	Approximate weight
External dimensions (Full Rack)	658 x 483 x 172 25.9 x 19 x 6.8	mm in.	Length x width x height Nominal dimensions
Weight (Full Rack)	30 66	Kg lb	Approximate weight

Table 1-3: General Characteristics

Rosemount CT4400	Value	Units	Comment
Supply voltage	110/230 ± 10%	Vac	N/A
Supply Frequency	60/50 ± 5%	Hz	N/A
Peak power consumption	50	W	Max. consumption
Frame and structure material	N/A	N/A	Anodized and powder coated aluminum
Housing material	N/A	N/A	Powder coated steel
Wetted materials	N/A	N/A	PF Acoated aluminum, 316 stainless steel, FKM and FFKM seals, CaF2 and BaF2 windows, protected gold coated aluminum mirrors
Measurement technique	N/A	N/A	Mid IR absorption spectroscopy
Mid IR source	N/A	N/A	Quantum Cascade™ Laser
Product Laser classification	Class 1	N/A	BSEN 60825-1: 2014 safety of laser products. Equipment classification and requirements (identical to IEC 60825-1 2014)
Inletgas port connector	6 or ¼	mm/in.	Swagelok® type
Outlet (exhaust) gas port connector	6 or ¼	mm/in.	Swagelok type
Measurement result signals	4 to 20	mA	4 or 8 channel outputs
Warm-up time	30	minutes	

Figure 1-4: Half Rack Dimensions

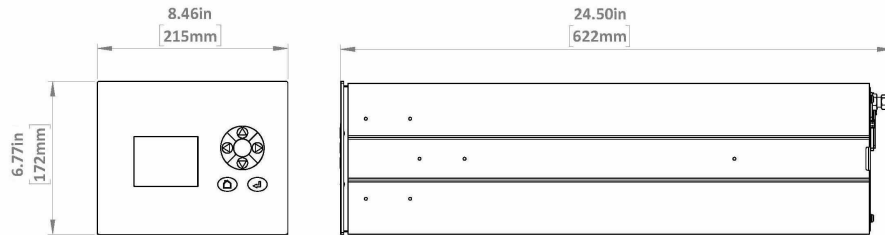

Figure 1-5: Full Rack Dimensions

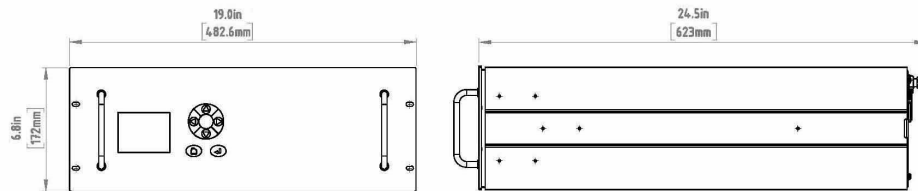

Table 1-4: Environmental Characteristics

Environmental characteristic	Value	Units	Comment
Operating temperature range	5 °C to 50 °C 41 °F to 122 °F	°C °F	Ambient temperature
Sample gas temperature range	15 °C to 50 °C 59 °F to 122 °F	°C °F	N/A
Sample gas Pressure	0 - 1	atm (abs)	Typically 1 atm (abs)
Sample gas flow rate	1 - 5	L/min	N/A
Sample gas moisture content	2	%	Ensure the dew point of the gas is at minimum 18 °F (10 °C) below the ambient temperature to avoid condensate in the gas lines
Sample gas particulate density	5	mg/m ³	Maximum
Sample gas particulate size	10	µm	Maximum
Maximum operating altitude	2000	m	N/A
Maximum relative humidity	80 @ 31 °C	%	Decreasing linearly to 50 % relative humidity at 104 °F (40 °C)

Table 1-4: Environmental Characteristics (continued)

Environmental characteristic	Value	Units	Comment
Overvoltage category	II	N/A	Numerical defining a transient overvoltage condition. Overvoltage Category II is for equipment intended to be supplied from the building wiring.
Pollution degree	2	N/A	Numerical indicating the level of pollution that may be present in the environment. Pollution degree 2: only non-conductive pollution occurs except that occasionally a temporary conductivity caused by condensation is expected.

Note

The Rosemount CT4400 Continuous Gas Analyzer is suitable for indoor use only.

1.8.1 Sample gas conditioning requirements

The sample gas temperature in [Table 1-4](#) indicates the temperature range that the analyzer can operate within.

The sample gas pressure in [Table 1-4](#) shows the pressure range that the analyzer can operate within. The sample gas pressure **MUST** not fluctuate more than -10 percent to ensure steady state conditions are being analyzed at all times. Sudden fluctuations in pressure will affect the analysis being performed.

In the event of a power failure any residual sample gas should be purged from the analyzer to ensure any corrosive gas elements are not left to contaminate/degrade the internal components. Failure to do so could result in irreparable damage to the analyzer.

Sample filtration may be required to ensure the gas sample particulate size and density does not exceed the requirements in [Table 1-4](#).

1.8.2 Optical description

The laser module is located in the core of the analyzer and the laser light beam passes through the sample cell. The sample cell contains a set of mirrors to create a path through the sample gas that is between 6.56 ft. (2 m) and 16.4 ft. (5 m) through multiple reflections of the laser beam in the cell. The laser beam exits the cell at the opposite end from where they entered and are directed using an optical block to a receiver.

By measuring and analyzing the light detected by the receiver unit, it is possible to accurately determine the concentration of the target molecules within the gas sample.

1.9 Unpacking the analyzer

⚠ WARNING

HEAVY ITEM

Handle the analyzer with caution during unpacking, installing, maintaining, and transporting to prevent crushing of hands, feet, or other body parts.

The analyzer weighs 33 lb (15 kg) for the half rack system and 66 lb (30 kg) for the full rack system. Rosemount recommends that the analyzer is moved by a minimum of two people when lifting and transporting the equipment.

Failure to properly handle the analyzer may cause injury to personnel, wear suitable protective gloves and protective footwear.

Procedure

1. Visually inspect the packaging to ensure there has been no damage in transit or storage.
2. Open the packaging and visually inspect the exterior of the analyzer for signs of damage, corrosion, gas leaks, or signs of previous overheating if returning from storage.
3. Report anything found to the maintenance organization.
4. Carefully lift the analyzer from the shipping container (handles are provided on the full rack system to aid this process).
5. Place the analyzer on a flat, stable surface that can accommodate the weight (up to 66 lb [30 kg]). This step requires two people to lift and transport the analyzer.

Figure 1-6: Half Rack Front and Rear Views

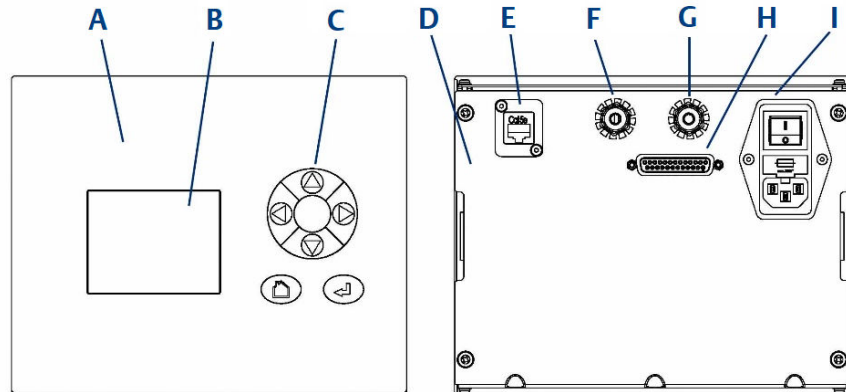

- A. Front panel
- B. Display screen
- C. User interface
- D. Rear panel
- E. Ethernet connection
- F. Sample gas outlet
- G. Sample gas inlet
- H. Analog output (4-20 mA)
- I. Mains power inlet

Figure 1-7: Full Rack Front and Rear Views

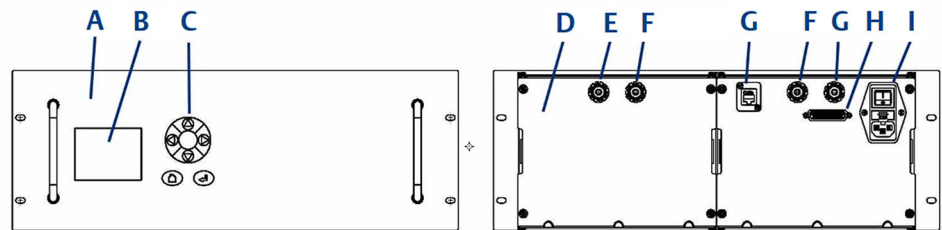

- A. Front panel
- B. Display screen
- C. User interface
- D. Rear panel
- E. Ethernet connection
- F. Sample gas outlet
- G. Sample gas inlet
- H. Analog output (4-20 mA)
- I. Mains power inlet

2 Install

2.1 Site selection and rack mounting

▲ WARNING

HEAVY ITEM

Handle the analyzer with caution during unpacking, installing, maintaining, and transporting to prevent crushing of hands, feet, or other body parts.

The analyzer weighs 33 lb (15 kg) for the half rack system and 66 lb (30 kg) for the full rack system. Rosemount recommends that the analyzer is moved by a minimum of two people when lifting and transporting the equipment.

Failure to properly handle the analyzer may cause injury to personnel, wear suitable protective gloves and protective footwear.

Procedure

1. The analyzer **MUST** be installed in an enclosed environment that is protected from the elements, humidity, and temperature variations for optimum performance.
2. Site selection for analyzer installation **MUST** account for the handles on the front face of the full rack system and rear entry for the cable and tube connections (see [Figure 2-1](#) and [Figure 2-2](#)).
3. Screw in rubber feet have been fitted to the base of the analyzer – if required these can be removed to aid assembly into the rack system being provided.
4. The full rack system has additional slotted holes on the front face for securing the analyzer to the rack system (see [Figure 2-2](#)).
5. The minimum tubing and cabling allowance defined in [Figure 2-1](#) and [Figure 2-2](#) at the rear of the analyzer **MUST** be accounted for when installing the rack system.

Figure 2-1: Half Rack Installation Requirements

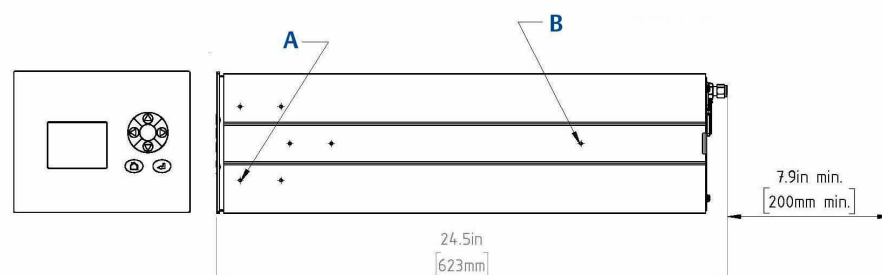

- A. Four off M4 mounting holes for customer supplied mounting ears (if required)
B. Three off M4 mounting holes for customer supplied rail (if required)

Figure 2-2: Full Rack Installation Requirements

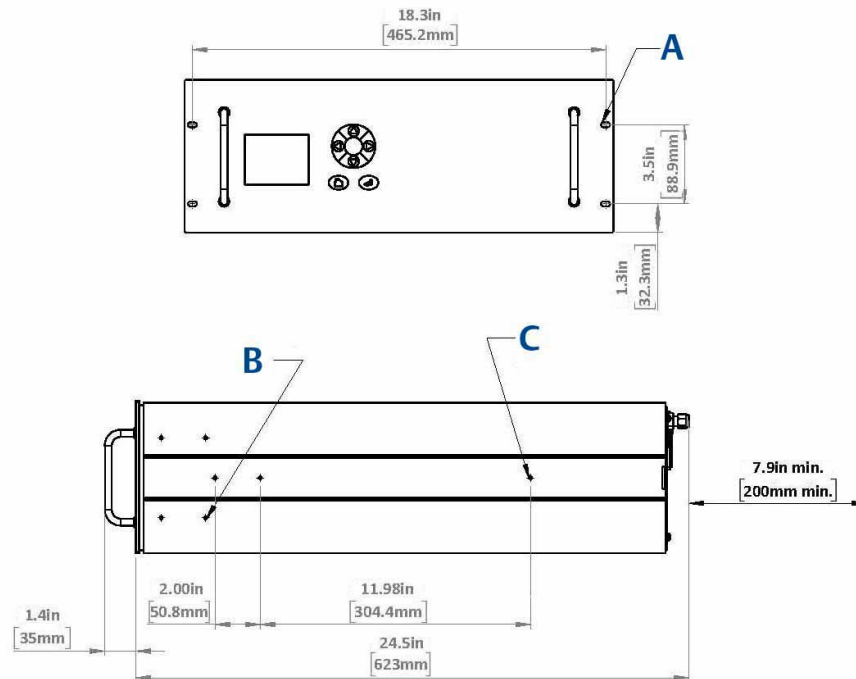

- A. Four off $\varnothing 5.5\text{mm}$ mounting slots
- B. Four off M4 mounting holes for customer supplied mounting ears (if required)
- C. Three off M4 mounting holes for customer supplied rail (if required)

6. If rigid tubing is being connected to the analyzer further clearance will be required to allow full access to the connections for installation and maintenance.
7. With rigid tubing fitted the analyzer will not be capable of being slid out of the rack on the slides.
8. Install the analyzer in a standard 19 in. (482.6 mm) rack system.

Note

Supply of the rack, telescopic slide rails, fitting and securing the analyzer into the rack is the responsibility of the Customer. (Typical requirement - 2 off telescopic slides, 24 in. (610 mm) long, 121.3 lb (55 kg) maximum load 2 in. (50.8 mm) over travel 4 in. (9.6 mm) slide thickness Lock-out Front disconnect.)

9. Installation of telescopic slides on the analyzer will be in accordance with the manufacturer's procedure the locations for the slide fixing points are provided in [Figure 2-1](#) and [Figure 2-2](#).

Figure 2-3: Analyzer With Telescopic Slides

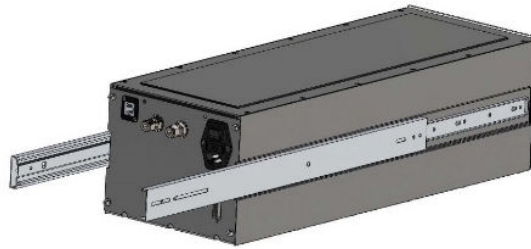

10. Due to the weight, care **MUST** be taken when installing the analyzer in the rack.

2.2 Gas inputs and outputs

The analyzer has provision for gas input and gas output, both of which are located on the rear panel of the analyzer (Figure 2-4).

⚠ WARNING

HAZARDOUS GAS

The product stream that the analyzer is examining may be hazardous even at low concentrations. Therefore, take special care to ensure that the sample gas return port either returns the sample gas to the product stream or discharges the sample gas to a location that will not cause a hazard.

Procedure

1. The sample supply line provided by the Customer must provide gas at a constant temperature to the sample gas input port on the analyzer to prevent condensation forming at any point in the sample supply line within the analyzer, which could reduce the accuracy of the gas analysis.
2. The gas sample enters the analyzer through the sample gas input port (C) Figure 2-4.
3. Once the gas sample passes through the measurement cell and it is expelled from the analyzer through the sample gas return port (B) Figure 2-4.
4. The Customer is responsible for ensuring that all expelled gases are disposed of in accordance with all local and national regulations.
5. Connections for the full rack system where a single gas sample inlet requiring dual cell analysis or two gas samples requiring separate analysis are shown in Figure 2-4.

Figure 2-4: Gas Inlet and Outlet Connections

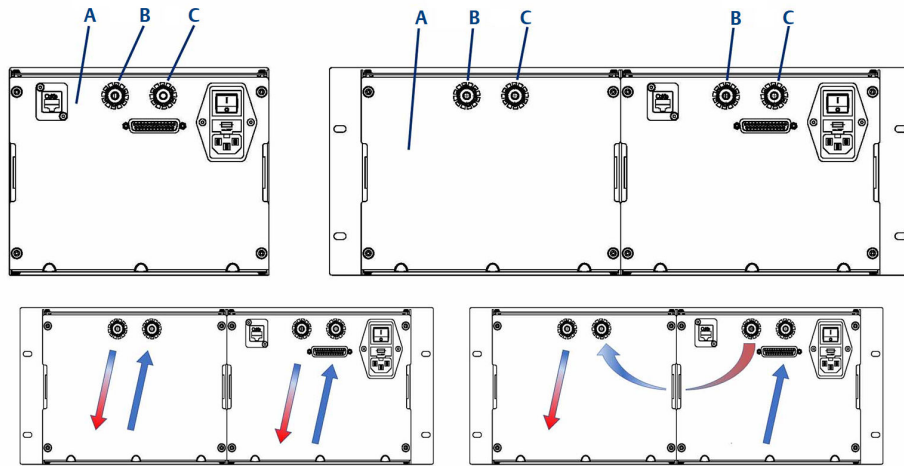

- A. Rear panel
- B. Sample gas outlet
- C. Sample gas inlet

2.3 Connecting the electrical/electronic inputs and outputs

This section discusses making the electrical connections to the analyzer.

⚠ DANGER

ELECTRIC SHOCK

The analyzer operates using mains voltage that is dangerous to life. Make sure that the power ON/OFF switch at the rear of the panel is set to OFF and the power cable plug is removed.

The analyzer **MUST** be earthed using a grounded three core cable suitable for the rating defined in the General Characteristics ([Table 1-3](#)).

Death or personal injury may result if this is not observed.

Figure 2-5: Electrical/Electronic Inputs and Outputs

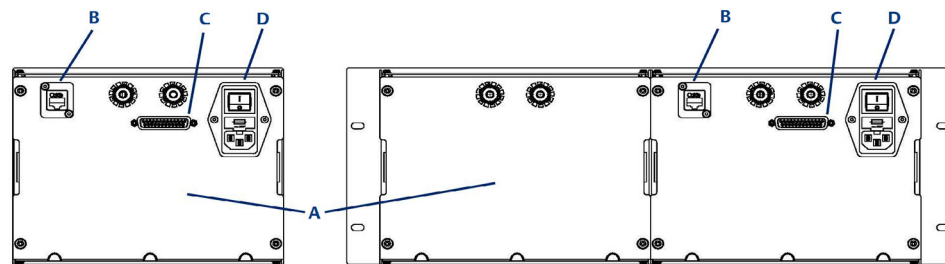

- A. Rear panel
- B. Ethernet connection
- C. D sub connector type - 25 way
- D. Mains power inlet

Procedure

1. Make electrical/electronic signal connections to the analyzer through connectors located on the analyzer's rear panel (see [Figure 2-5](#)).
2. Use the wiring diagram to make the electrical connections as shown in [Table 2-1](#), [Table 2-2](#), and [Engineering drawings](#).
3. Power to the analyzer is connected through the Mains Power Inlet ([Figure 2-5](#), D) using the cable provided.
4. The Ethernet connector ([Figure 2-5](#), B) provides an Ethernet output from the analyzer that may be used for downloading data for failure diagnosis purposes.
5. The results of the gas analysis are output from the analyzer through the Analog Output connection ([Figure 2-5](#), C) and sent to your process control center.

Table 2-1: Analog Outputs Half Rack System, 25 Way Socket

Pins	Function	Measurement (point of display)
1 & 14	Analog channel 0, set in config file (4-20 mA, SELV)	Sample gas measurement 1
2 & 15	Analog channel 1, set in config file (4-20 mA , SELV)	Sample gas measurement 2
3 & 16	Analog channel 2, set in config file (4-20 mA, SELV)	Sample gas measurement 3
4 & 17	Analog channel 3, set in config file (4-20 mA, SELV)	Sample gas measurement 4
9 & 22	Status output 1 (check function), optional (dry contacts: 1A, 30 Vdc)	N/A
10 & 23	Status output 2 (maintenance required), optional (dry contacts: 1A, 30 Vdc)	N/A
11 & 24	Status output 3 (out of specification), optional (dry contacts: 1A, 30 Vdc)	N/A
12 & 25	Status output 4 (failed), optional (dry contacts: 1A, 30 Vdc)	N/A

Figure 2-6: Analog Connector 25-Way Socket



Table 2-2: Analog Outputs Full Rack System, 25-Way Socket

Pins	Function	Measurement (position on display)
1 & 14	Analog channel 0, set in config file (4-20 mA, SELV)	Sample gas measurement 1
2 & 15	Analog channel 1, set in config file (4-20 mA, SELV)	Sample gas measurement 2
3 & 16	Analog channel 2, set in config file (4-20 mA, SELV)	Sample gas measurement 3
4 & 17	Analog channel 3, set in config file (4-20 mA, SELV)	Sample gas measurement 4
5 & 18	Analog channel 4, set in config file (4-20 mA, SELV)	Sample gas measurement 5
6 & 19	Analog channel 5, set in config file (4-20 mA, SELV)	Sample gas measurement 6
7 & 20	Analog channel 6, set in config file (4-20 mA, SELV)	Sample gas measurement 7
8 & 21	Analog channel 7, set in config file (dry contacts: 1A, 30 Vdc)	Sample gas measurement 8
9 & 22	Status output 1 (check function), optional (dry contacts: 1A, 30 Vdc)	N/A
10 & 23	Status output 2 (maintenance required), optional (dry contacts: 1A, 30 Vdc)	N/A
11 & 24	Status output 3 (out of specification), optional (dry contacts: 1A, 30 Vdc)	N/A
12 & 25	Status output 4 (failed), optional (dry contacts: 1A, 30 Vdc)	N/A

3 Start-up procedure

3.1 Introduction

⚠ CAUTION

EQUIPMENT DAMAGE

Damage to the analyzer may result from a failure to follow this procedure.
Always follow the start-up procedure.

The analyzer normally operates continuously. It should only be necessary to start up the analyzer under the following circumstances:

- When the analyzer is first switched on following installation.
- Following repair or maintenance.
- When the analyzer has been switched off as part of a plant shutdown or maintenance.

3.2 Preparation for use

The analyzer must be installed and fully commissioned prior to startup.

⚠ DANGER

ELECTRIC SHOCK

The analyzer operates using mains voltage that is dangerous to life. Make sure that the power ON/OFF switch at the rear of the panel is set to OFF and the power cable plug is removed.

The analyzer **MUST** be earthed using a grounded three core cable suitable for the rating defined in the General Characteristics ([Table 1-3](#)).

Death or personal injury may result if this is not observed.

⚠ CAUTION

EQUIPMENT DAMAGE

Do not power up or try to operate the analyzer unless it is physically secure and all electrical and pneumatic connections to the analyzer are in place.

Before commencing the start-up process, it is important to ensure that the electrical power, sample gas handling and any calibration gases that are required are available.

3.3 Start-up procedure

NOTICE

The gases shown in the screenshots and the measurements may be different from those shown in your particular analyzer. They indicate the functionality of the software, which is the same regardless of the gases being measured.

CAUTION

To stop the start-up procedure at any time, set the main circuit breaker to *OFF*.

To start the analyzer, perform the following steps:

Procedure

1. Visually inspect the exterior of the analyzer for signs of damage, corrosion, gas leaks, or overheating. Report anything found to the maintenance organization.
2. Ensure that the analyzer has been correctly installed.
See [Install](#).
3. Ensure that the **On/Off** switch at the rear of the analyzer is set to **I (ON)**.

Figure 3-1: Rear Panel ON/OFF Switch

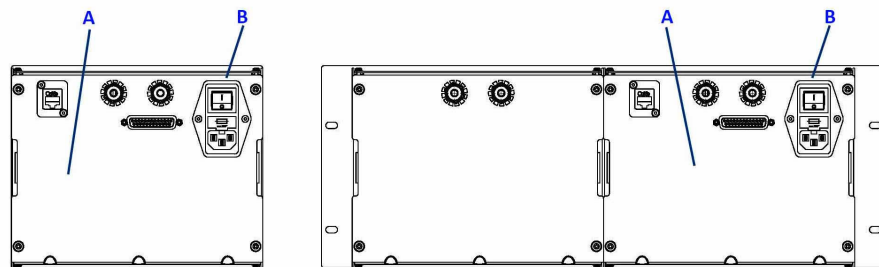

- A. Rear panel
- B. On/Off switch

4. The start-up sequence commences automatically under software control.
5. After a few minutes, the **Gas Sensor Main** screen ([Figure 3-2](#)) appears on the display controller. If it does not, report the fault to maintenance.

Figure 3-2: Gas Sensor Main Screen

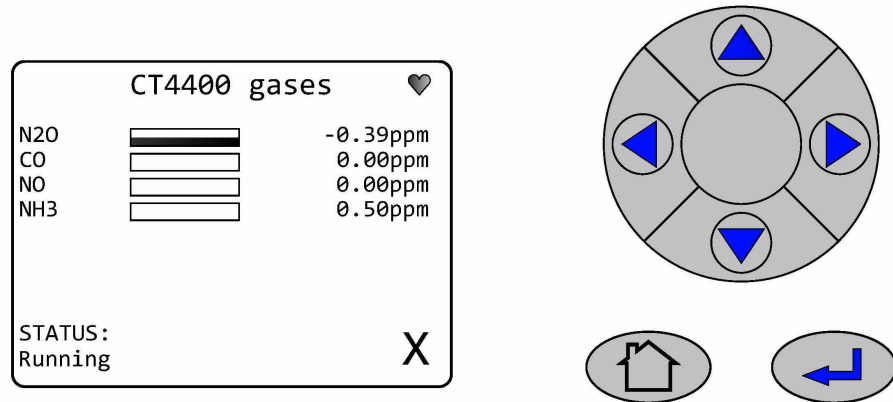

6. Start/open the return system installed for the sample gas handling for the analyzer.
7. Start the gas handling system that conditions the sample gas before it is fed into the analyzer.
8. Allow the analyzer sufficient time to stabilize in accordance with [Table 1-3](#) before steady state measurements are taken.

4 Operating the analyzer

4.1 Introduction

This chapter describes the controls, displays, and indicators on the Rosemount CT4400 and how to use the display controller located on the front panel of the analyzer.

NOTICE

The gases shown in the screenshots and the measurements may be different from those shown in your particular analyzer. They indicate the functionality of the software, which is the same regardless of the gases or gas concentrations being measured.

4.2 Normal operation

The analyzer is designed for long term continuous operation, and therefore its normal state is to be switched on and performing gas measurements. The analyzer is usually only switched off for maintenance. The shutdown procedure used to switch off the analyzer is described in [Shutdown procedure](#).

Provided that the [Start-up procedure](#) has been followed, the analyzer does not require any human intervention during normal operation other than occasional calibration checks as described in [Gas calibration](#).

During normal operation, either the *Gas Sensor Main* screen ([Figure 4-1](#)) or the *Pressure and Temperature* screen ([Figure 4-2](#)) is shown on the display controller. To toggle between these two screens, press .

Figure 4-1: Gas Sensor Main Screen

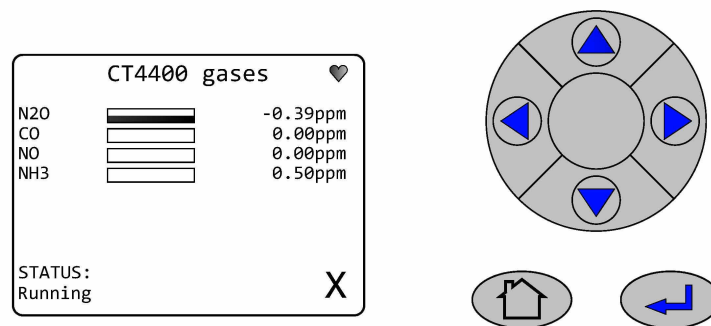
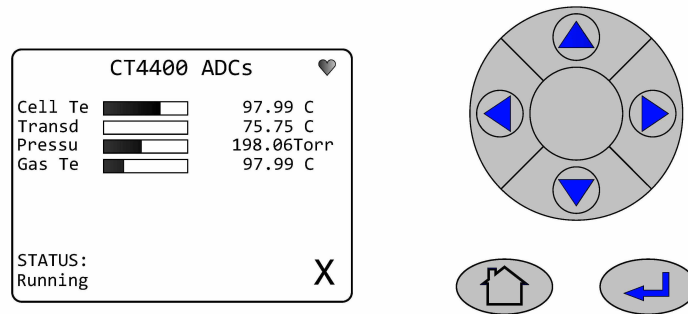

Figure 4-2: Pressure and Temperature Screen



⚠ CAUTION

UNSERVICEABLE EQUIPMENT

If the pressure and temperature measurements are out of tolerance, refer to [Troubleshooting and diagnostics](#) for guidance.

On both the Gas Sensor Main screen (Figure 4-1) and the Pressure and Temperature screen (Figure 4-2) has no function when the analyzer is operating correctly. If, however, the software detects a fault and an error message is displayed, press to get further information on the error.

On both the *Gas Sensor Main* screen and the *Pressure and Temperature* screen, if the analyzer makes more measurements than can fit on the display, use and to scroll up and down the list.

4.3 Display controller

Operation of the analyzer is controlled primarily through the display controller (Figure 4-3, A).

Figure 4-3: Front Panel Display Controller

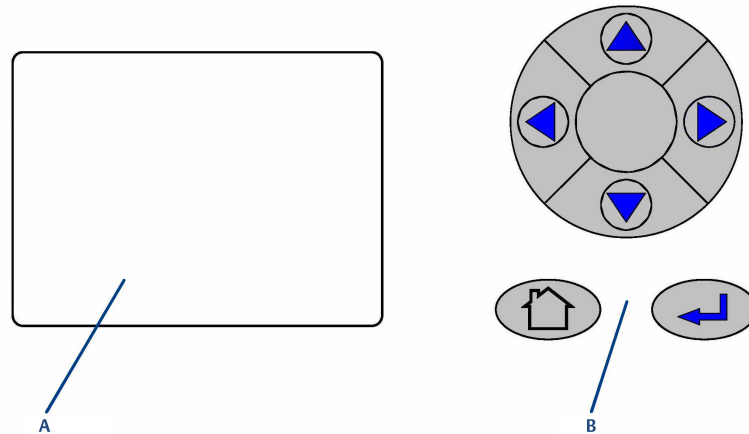

- A. LCD display
- B. Navigation buttons

The LCD display (A) can be used to display:

- Gas concentration measurements obtained.
- Operating temperature and pressure.
- **Help** screens.
- Step-by-step calibration.
- Diagnostics.

The navigation buttons (B) are configured to perform different functions according to which software screen is shown on the LCD display.

Table 4-1: Display Controller Navigation Button Functions









Button	Description
	Normally used to scroll up. Referred to as UP .
	Normally used to scroll down. Referred to as DOWN .
	Normally used to select. Also accesses the Main Menu from the Home screen. Referred to as RIGHT .
	Used to go back to the previous screen. No function from the Home screen. Referred to as LEFT .
	Used to return to the Home screen.

Table 4-1: Display Controller Navigation Button Functions (continued)

Button	Description
	Generally used to select an alternative function. Also allows you to toggle between gas and physical measurements from the <i>Home</i> screen. Referred to as ENTER .

The analyzer employs Intelligent Device Management, which enables self-monitoring and diagnostics. This ensures that operators are made aware of malfunctions so they can take appropriate action. [Table 4-2](#) defines the symbols that may be displayed.

Table 4-2: Diagnostic symbols

OK	System running
	Maintenance required: still valid output signal
	Out of specification: signal out of the specified range
	Indicates the analyzer is performing a calibration or validation or that the software has been deliberately stopped.
X	Failure: non-valid output signal

4.4 Gas sensor main screen

When the analyzer is switched on, at the end of the startup procedure, the **Gas Sensor Main** screen ([Figure 4-4](#)) appears.

The **Gas Sensor Main** screen is the screen that is normally displayed.

NOTICE

The gas concentrations shown in the following screenshots may be different from those shown in your particular analyzer. The screenshots indicate the functionality of the software, which is the same regardless of the gases or gas concentrations being measured.

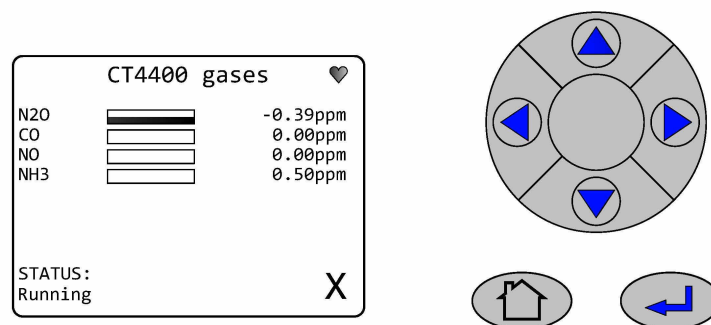

Figure 4-4: Gas Sensor Main Screen





The **Gas Sensor Main** screen displays the gas concentration measurements obtained by the analyzer. In the example shown in [Figure 4-4](#), the gases Nitric Oxide (NO), Nitrous Oxide (N₂O), Carbon Monoxide (CO) and Ammonia (NH₃) are being measured and, for each gas, the concentration detected is in parts per million (ppm).

At the end of the start-up procedure, the gas measurements initially appear as 0.00 ppm until the first readings are taken. After a few seconds, the initial gas concentrations are displayed.

The **Gas Sensor Main** screen also shows the status of the analyzer. In the example shown in [Figure 4-4](#), the analyzer is *Running* and *OK* (e.g., no faults have been identified).

If a fault is identified,  is displayed; if maintenance is required,  is displayed.

 is a link between the **Gas Sensor Main** screen ([Figure 4-4](#)) and the **Pressure and Temperature** screen ([Figure 4-5](#)). Press  to toggle between the two screens.

 is a link to the **Home Screen**. Press to go to a **Help** screen (described in [Help system](#)).

On the **Gas Sensor Main** screen, has no function when the analyzer is operating correctly.

If, however, the software detects a fault, an error message is displayed. Press  to get further information on the error.

4.5 Pressure and temperature screen

The **Pressure and Temperature** screen ([Figure 4-5](#)) shows pressure and temperature measurements taken inside the analyzer. The measurements shown in the manual are indicative and may vary depending on the configuration of your individual system.

Figure 4-5: Pressure and Temperature Screen

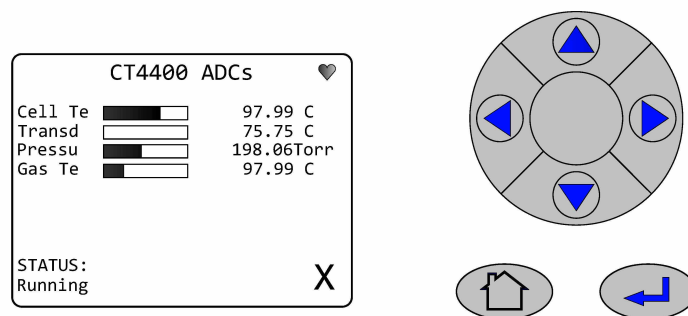

The **Cell Te** reading is the temperature, in °C, of the analysis cell.

The **Transd** reading is the temperature, in °C, of the Transducer.

The **Pressu** reading is the pressure, in Torr, inside the analysis cell.

The **Gas Te** reading is the temperature, in °C, of the gas within the analysis cell.

NOTICE

A *Torr* is a non-SI unit of pressure defined as 1/760 of standard atmospheric pressure and is equal to the fluid pressure of 1 mm of mercury.

4.6 Help system

The analyzer software includes a context-sensitive help system. Help messages are displayed at either the top or bottom of the screen as appropriate.



When the  button is pressed it takes you to the home page. [Figure 4-6](#) shows an example of a help screen.

Figure 4-6: Example of a Help Screen

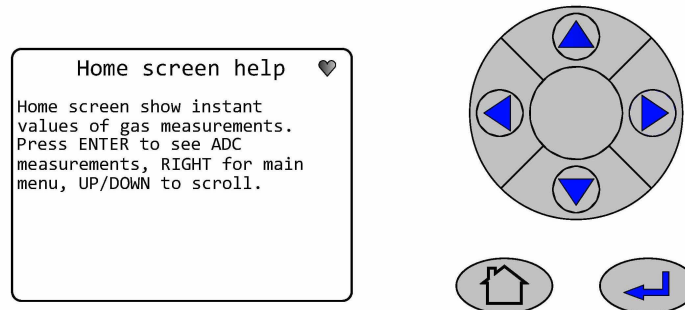

4.7 Main menu

To access the *Main menu* ([Figure 4-7](#)), press  on either the **Gas Sensor Main** screen ([Figure 4-4](#)) or the **Pressure and Temperature** screen ([Figure 4-5](#)). The *Main menu* options are:



- DIAGNOSTICS:** Displays various parameters used in the internal calculations and compares desired and actual parameters, for example, the analysis cell pressure and temperature. The diagnostics routines and screens are used to perform fault diagnosis.
- FAULTS:** Navigates to a screen that lists any faults affecting the analyzer. This option is used as part of the failure diagnosis procedures.
- GAS SERVICE:** Allows you to check the sensor readings against a known gas source (verification) or, if necessary, to calibrate the analyzer against that known gas source (calibration).
- DATA SERVICE:** Navigates to a screen that allows data to be downloaded from the analyzer. The downloaded data is used to diagnose faults.
- SYSTEM:** Navigates to a screen that allows you to shut down the analyzer or access system information, such as software versions or IP addresses.

The main motherboard IP address can also be changed from this menu. Some of these options are not available on older analyzers.

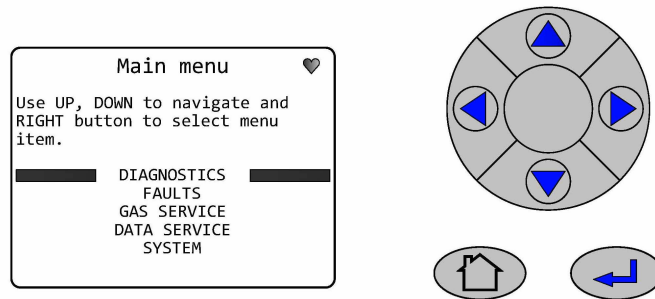
Figure 4-7: Main Menu



4.8 BACK button

On most of the software screens,  is configured as a **BACK** button. Press  to return to the previous screen.

5 Verifying gas concentrations

5.1 Verification

Verification flows the known gas concentration through the analyzer and gives you a display of the measurement, the cylinder value, and the difference between the two. You can use verification to confirm that the analyzer is within tolerance. If it is out of tolerance, perform a calibration (see [Calibration](#)).

5.1.1 Zero verification

Zero verification confirms that when no sample gas is flowing through the analyzer, the gas concentrations measured by the analyzer are zero. To zero verify, compare the analyzer measurements to a known sample gas using the following procedure:

Procedure



1. Use nitrogen gas of instrument gas purity as the zero verification gas.
2. Ensure that a pressure regulator is connected to the nitrogen gas bottle.
3. Connect a hose from the nitrogen gas bottle through a T-piece to the sample supply port on the rear of the analyzer.
4. Connect an excess flow line to the unused port on the T-piece and route the excess flow line to a suitable extractor.
5. To ensure an accurate zero measurement, the analyzer must have been switched on for a minimum of 30 minutes prior to verifying the reading.
6. On the display controller of the analyzer select the **Main Menu** screen.
7. Scroll  or  and select **GAS SERVICE**. Press .

Figure 5-1: Gas Service



8. Scroll ▲ or ▼ and select **PER GAS**. Press ►.

Figure 5-2: Per Gas

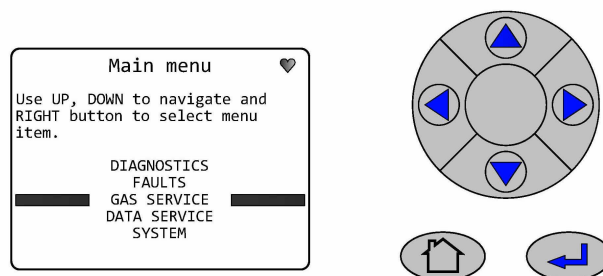
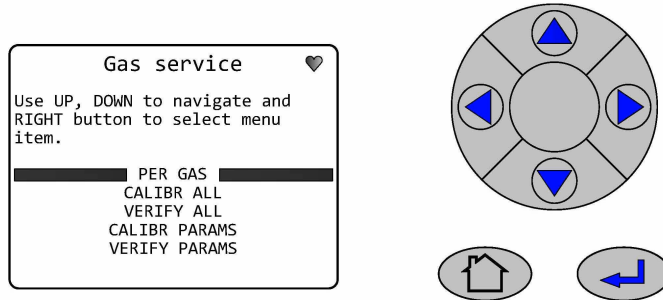

9. Scroll ▲ or ▼ and select from the list the gas to be tested. Press ►.

Figure 5-3: Select Gas Screen

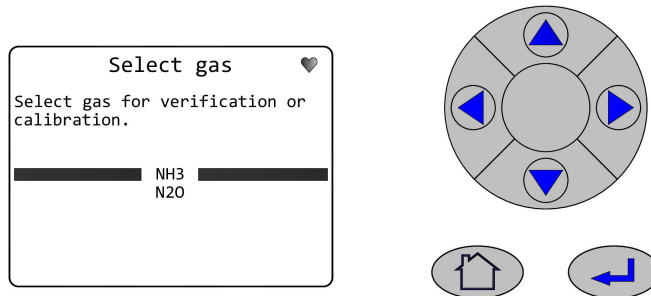

10. Scroll ▲ or ▼ and select **RUN ZERO**. Press ►.

Figure 5-4: For NH3

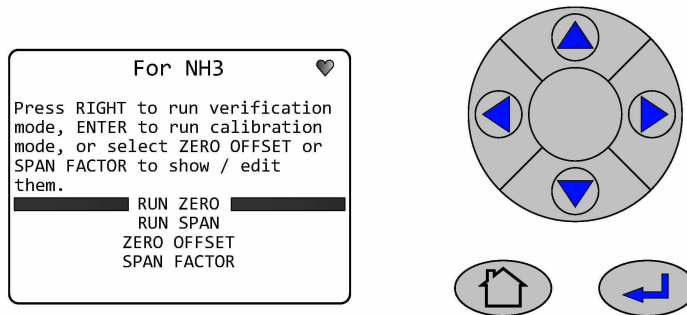

- Allow the concentration readings to stabilize.

Figure 5-5: Result

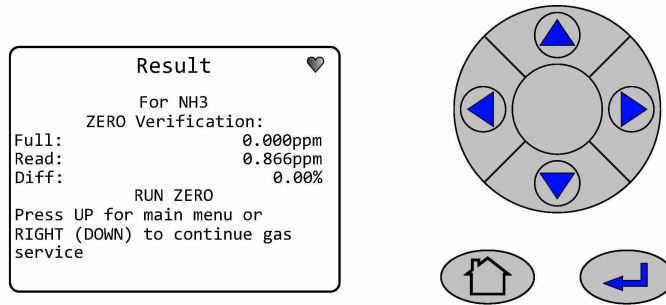

This screen gives a reading of the concentration of the selected gas that is present as an impurity in the nitrogen calibration gas.

In the example the gas being measured is NH₃, and the analyzer has detected a concentration of 0.866 ppm.

If the reading is within tolerance, no further action is required.

- Press  to end the zero verification process.
- Press the appropriate button.





Option	Description
	To return to the Gas Service Screen .
	To select the next gas from the Select Gas screen .
	To return to the Main Menu .
	To return to the Gas Sensor Main screen (Figure 4-4).

Figure 5-6: Next Gas Service



If the reading is outside tolerance, follow the [Zero calibration](#).

5.1.2 Span verification

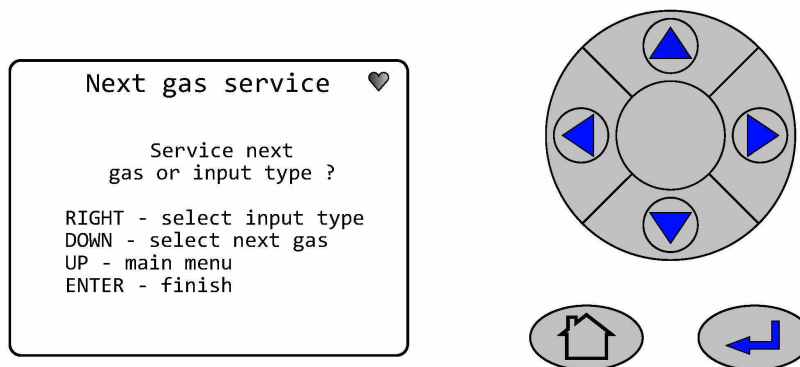
To verify the span gas concentrations measured by the analyzer when reference gas is flowing:

Procedure



1. Use a certified reference gas cylinder as the source of the span verification gas.
2. Ensure that a pressure regulator is connected to the reference gas bottle.
3. Connect a hose from the reference gas bottle, through a T-piece, to the sample supply port on the rear panel of the analyzer.
4. Connect an excess flow line to the unused port on the T-piece and route the excess flow line to a suitable extractor.
5. On the display controller, browse to the *Main menu*.
6. Press  or , select *GAS SERVICE*. Press .

Figure 5-7: Main Menu



7. Scroll ▲ or ▼ and select *PER GAS*. Press ►.

Figure 5-8: Gas Service

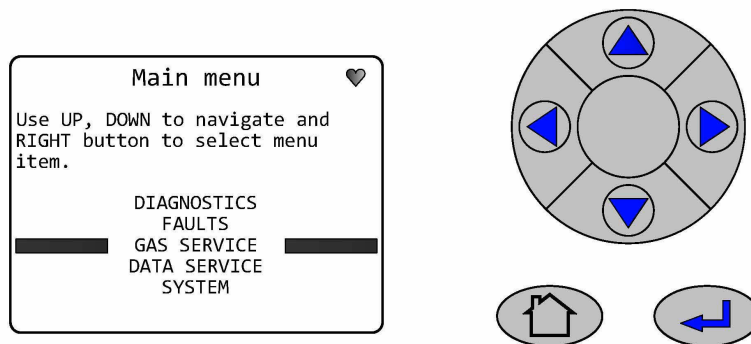
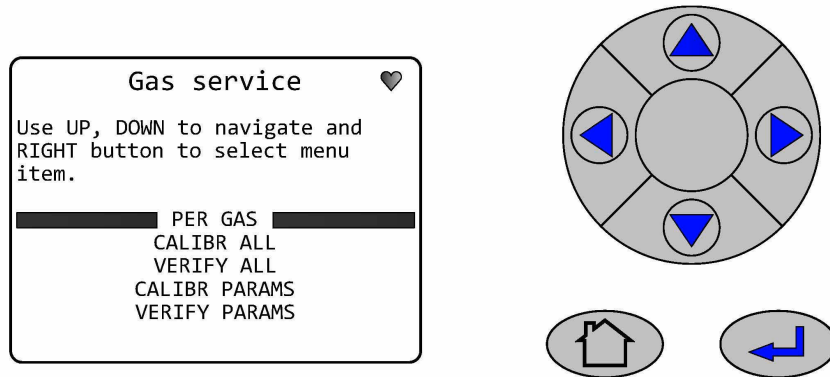

8. Scroll ▲ or ▼ and select from the list the gas to be tested. Press ►.

Figure 5-9: Select Gas Selection

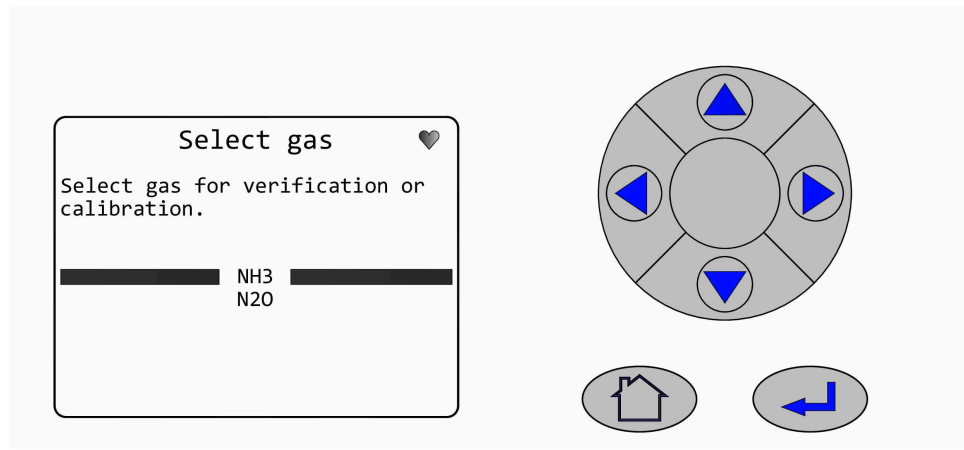

9. Scroll ▲ or ▼ and select RUN SPAN. Press ►.

Figure 5-10: For NH3

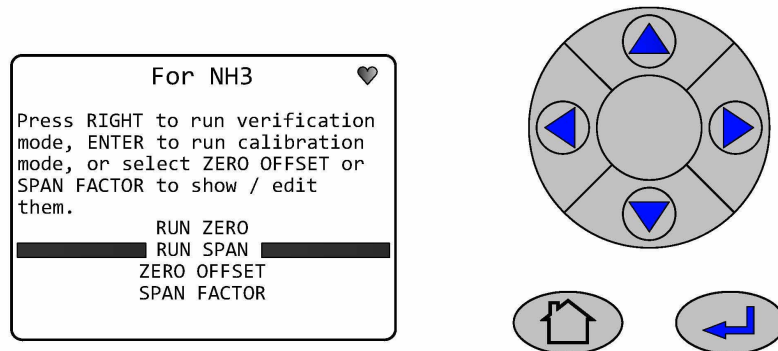

Note

Allow the concentration readings to stabilize.

10. Use ◀ or ▶ to highlight each digit in turn; then use ▲ or ▼ to increase or decrease the value until the concentration displayed matches the cylinder you are using. Once the concentration has been set, Press ► to accept.

Figure 5-11: Verify Input

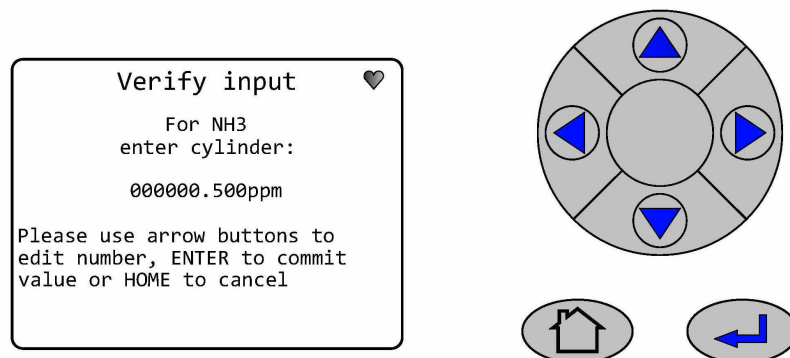

11. The **VERIFY SPAN** screen will be visible while the analyzer makes the verification measurement. Allow the concentration readings to stabilize. After the purge time set has elapsed, the **RESULT** screen will then be shown.

Figure 5-12: Verify Span

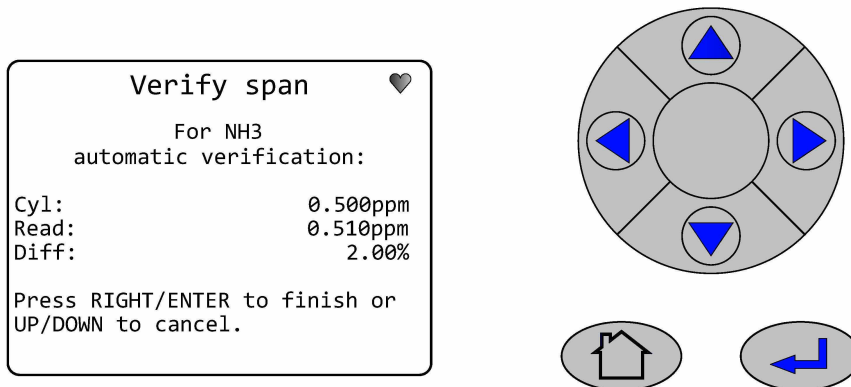

12. This **RESULT** screen gives a reading of the concentration for the selected gas that is present as an impurity in the calibration gas. In the example the gas being measured is NH₃, and the analyzer has detected a concentration of 0.510 ppm.

Figure 5-13: Result Screen

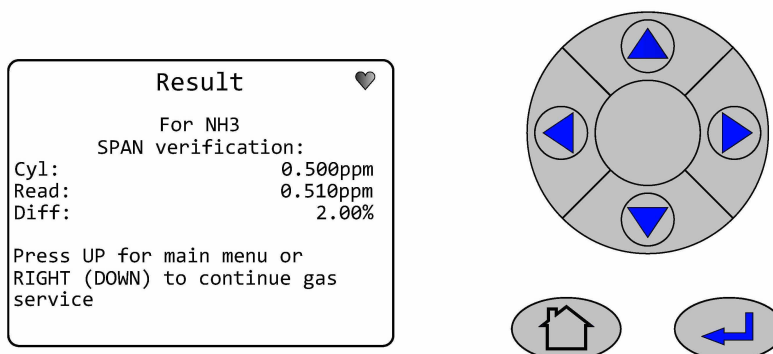

If the reading is within tolerance, no further action is required.

If the reading is outside tolerance, follow the zero calibration procedure in [Zero calibration](#)

13. Press  to end the span verification process

14. Press the appropriate button





Option	Description
	To return to the <i>Gas Service Screen</i> .
	To select the next gas from the <i>Select Gas screen</i> .
	To return to the <i>Main Menu</i> .
	To return to the <i>Gas Sensor Main screen</i> (Figure 4-4).

Figure 5-14: Next Gas Service



6 Gas calibration

6.1 Required tools

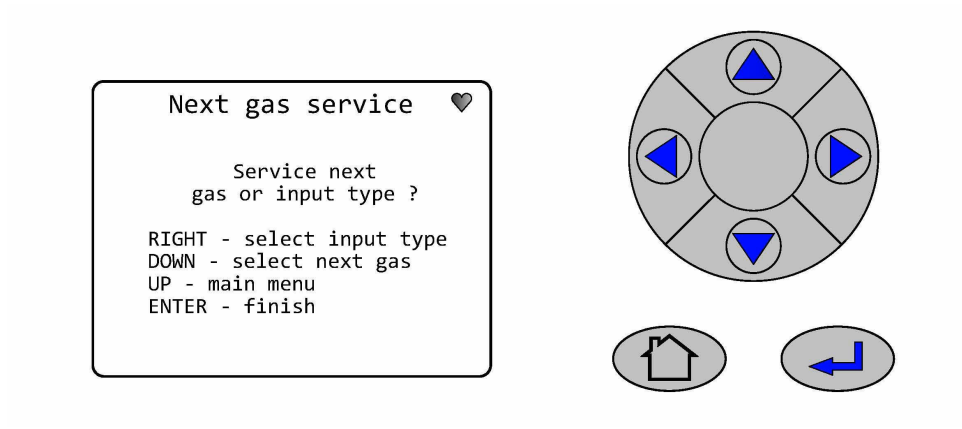
The gas concentrations measured by the analyzer can be validated against a known sample gas or calibrated to match it by using the following gas calibration procedure.

To calibrate the analyzer, you need the following items:

- Nitrogen gas of instrument gas purity for use as a zero calibration gas
- Suitable span calibration gases for each gas measured
- Gas bottle pressure regulators
- Interconnecting hoses to connect the gas bottles to the analyzer
- A T-piece and excess flow line

NOTICE



In the case of gases, such as H₂O, for which it is not normally possible to obtain calibrated gas cylinders, it will usually be measured by the same laser as some other gas. Validating the other gases measured by the analyzer (particularly any which are measured by the same laser as H₂O) can demonstrate that the system is functioning correctly, meaning there is no need to calibrate the water measurement directly.

If calibration must be carried out (e.g., for legal requirements), it can be calibrated by using a water vapor generator to supply a known concentration of water vapor.

6.2 Gas service menu definitions

The **GAS SERVICE** menu screen can be accessed from the **Main Menu** screen.

This gives the operator access to a number of software routines and screens that are used for calibration and maintenance of the analyzer.



Where more options are available than can be displayed on the screen use the  or  keys to scroll up or down onto the next page. The screen will continually wrap around until the option required is highlighted.

Pressing the **Forward key**  will move to the next screen where available as shown in the **GAS Service/Per Gas** example below.

Pressing the screen **Refresh key**  at any time will refresh the current display screen if required by the operator.

PER GAS	allows for gas calibration or verification on a gas by gas basis.
CALIBR ALL	not an option available for the Rosemount CT4400 analyzer.
VERIFY ALL	not an option available for the Rosemount CT4400 analyzer.

- CALIBR PARAMS** allows configuration of the purge time for Gas Calibration.
- VERIFY PARAMS** allows configuration of the purge time for Gas Verification.
- STREAM SWITCH** not an option available for the Rosemount CT4400 analyzer.

Pressing the **Back** key  will return to the previous screen. Pressing the **Home** key  at any time will return to the Main Menu screen.

6.3 Calibration

Calibration flows the known cylinder gas through the analyzer and then adjusts the readout until the measurement matches the cylinder. The analyzer then applies this adjustment to all measurements until the next calibration. There are two circumstances in which you may want to calibrate:

1. After you verify gas concentrations (see [Verifying gas concentrations](#)) and find that the analyzer readings are outside of tolerance.
2. At regular intervals, such as once a month.

6.3.1 Zero calibration

The zero calibration procedure adjusts for any zero offset in the measurement. Zero calibration is done by calibrating the analyzer measurements against a known sample gas using the following procedure.

Prerequisites

Run the analyzer at a stable temperature for at least thirty minutes prior to commencing this procedure.

Procedure

1. Use nitrogen gas of "instrument gas" purity as the zero calibration gas.
2. Ensure that a pressure regulator is connected to the nitrogen gas bottle.
3. Connect a hose from the nitrogen gas bottle through a T-piece to the sample supply port on the rear of the analyzer.
4. Connect an excess flow line to the unused port on the T-piece and route the excess flow line to a suitable extractor.
5. On the display controller of the analyzer, browse to the **Main menu** as described in [Gas service menu definitions](#).

6. Using ▲ and ▼, select **GAS SERVICE**. Press ►.

Figure 6-1: Main Menu

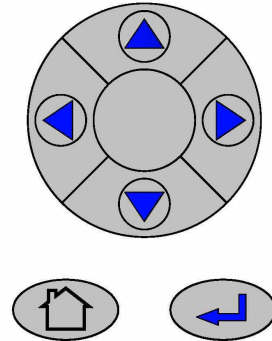
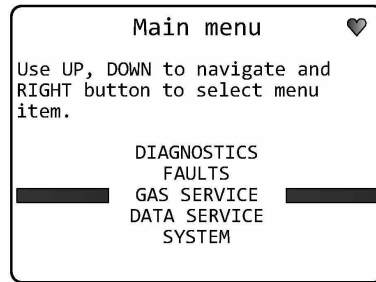

7. Using ▲ and ▼, select **PER GAS**. Press ►.

Figure 6-2: Per Gas

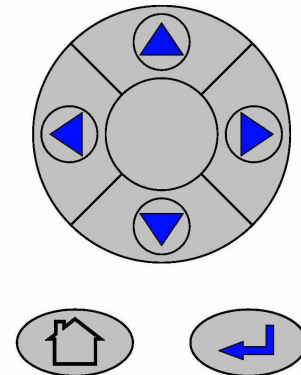
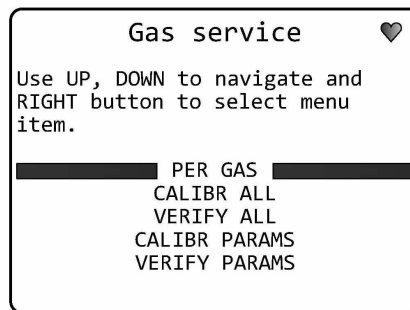

8. Scroll ▲ or ▼ and select from the list the gas to be tested. Press ►.

Figure 6-3: Select Gas Screen

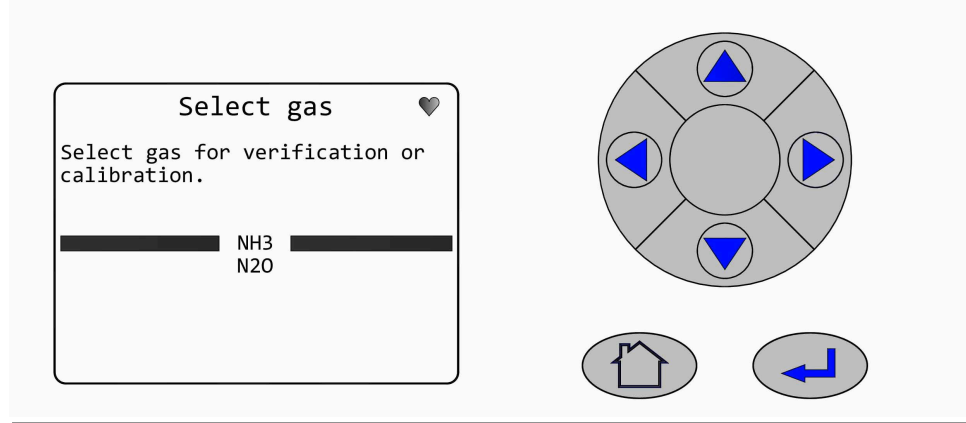

Manually adjust the ZERO OFFSET

Procedure

1. Use ▲ or ▼, select ZERO OFFSET. Press ►.

Figure 6-4: Zero Offset

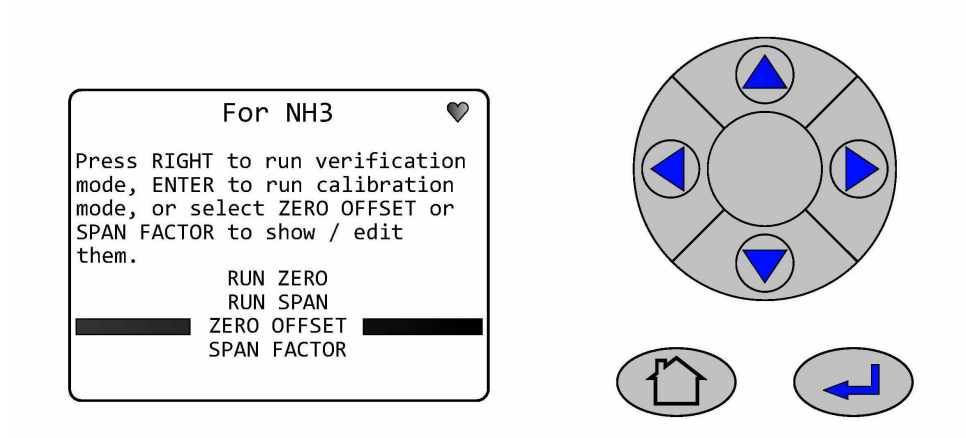





2. Use  or  or  or  as required to set required value, Press  to confirm.

Figure 6-5: Gas Compensation - Zero Offset



ZERO CALIBRATE

Procedure

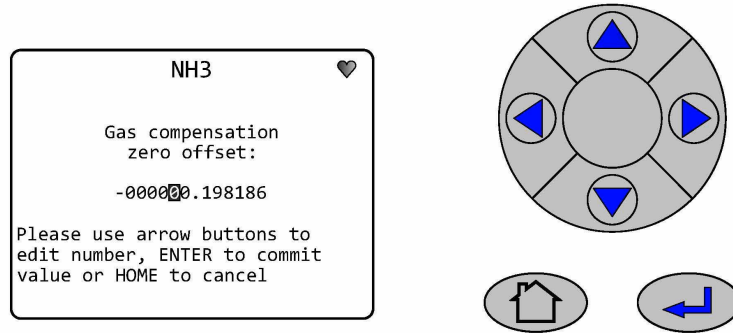
1. Press  to start the ZERO CALIBRATION process.

Figure 6-6: Run Zero Calibration



2. Allow the concentration to stabilize.

Figure 6-7: Calibrate Zero for NH3

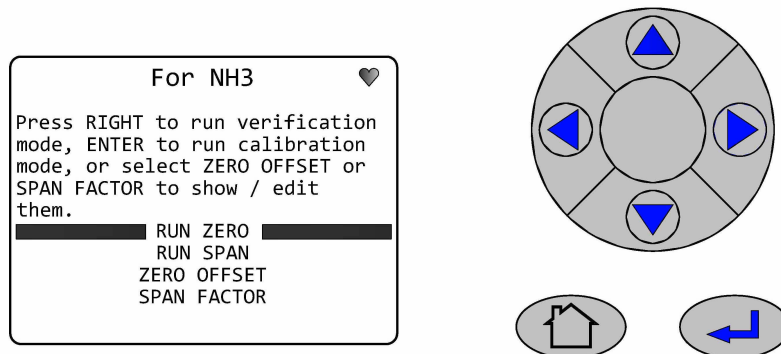
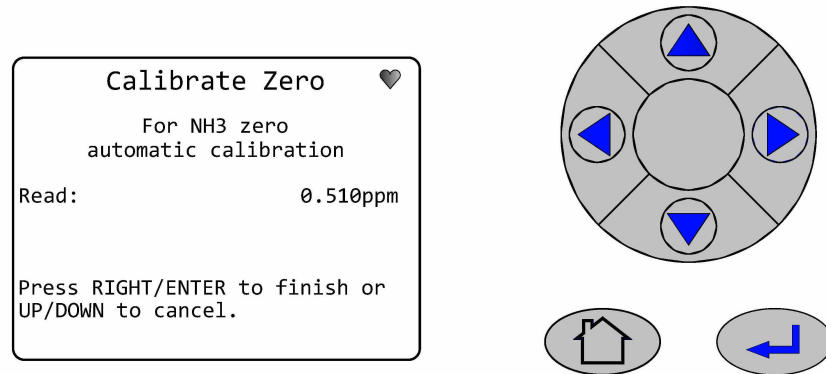

This screen gives a reading of the concentration of the selected gas that is present as an impurity in the nitrogen calibration gas, as measured by the analyzer.

In the example shown the gas being measured is NH₃ (ammonia), and the analyzer has detected a concentration of 0.510 ppm (vol).

3. To abort the calibration process, press ▲ or ▼, otherwise the analyzer will perform the **ZERO CALIBRATION**, either after waiting for the purge time, or when ► or ◀ is pressed, whichever is sooner. The result of the calibration will then be displayed, as below.

Figure 6-8: Result

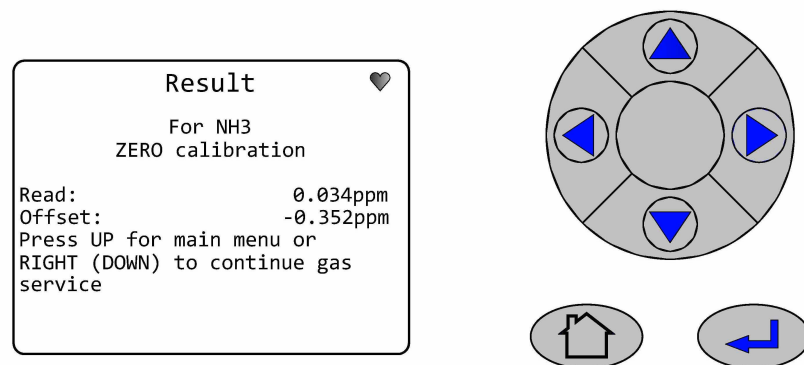

4. Press the appropriate button

Option	Description
	To return to the <i>Gas Service Screen</i> .



Option	Description
	To select the next gas from the Select Gas screen .
	To return to the Main Menu .
	To return to the Gas Sensor Main screen (Figure 4-4).

Figure 6-9: Next Gas Service



6.3.2 Span calibration

The span gas concentrations measured by the analyzer when reference gas is flowing can be verified and, if necessary, calibrated against the known reference gas by using the following procedure.

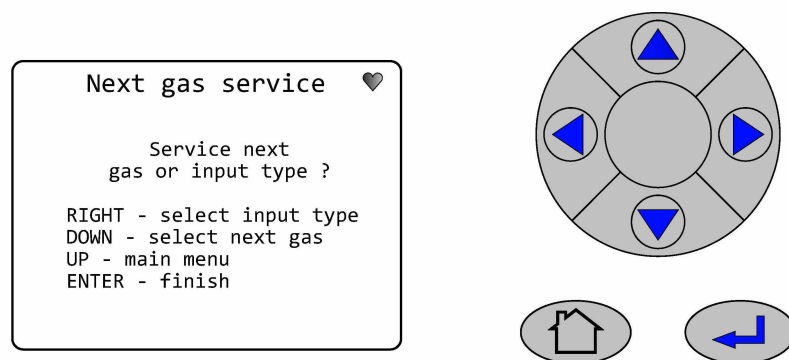
Prerequisites

Run the analyzer at a stable temperature for at least thirty minutes prior to commencing this procedure.

Procedure

1. Use a certified reference gas cylinder as the source of the span calibration gas.
2. Ensure that a suitably rated pressure regulator is connected to the reference gas bottle.
3. Connect a hose from the reference gas bottle, through a T-piece, to the sample supply port on the rear panel of the analyzer.
4. Connect an excess flow line to the unused port on the T-piece and route the excess flow line to a suitable extractor.
5. On the display controller of the analyzer select the **Main Menu** screen.

6. Use ▲ or ▼ and select **GAS SERVICE**. Press ►.

Figure 6-10: Select Gas Service

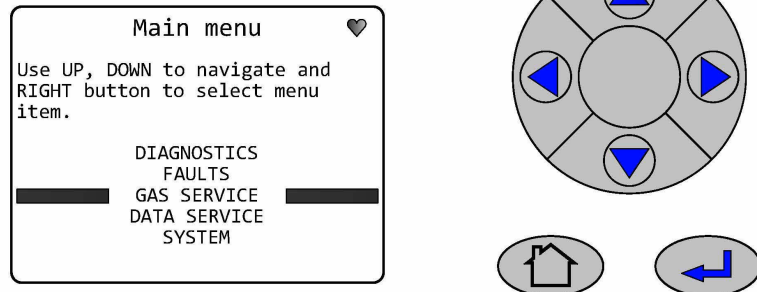

7. Use ▲ or ▼ and select **PER GAS**. Press ►.

Figure 6-11: Per Gas

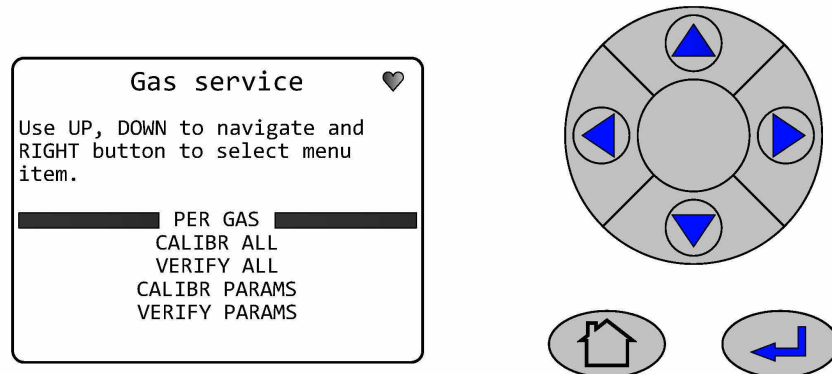

8. Use ▲ or ▼ and select from the list the gas to be tested. Press ►.

Figure 6-12: Select Gas

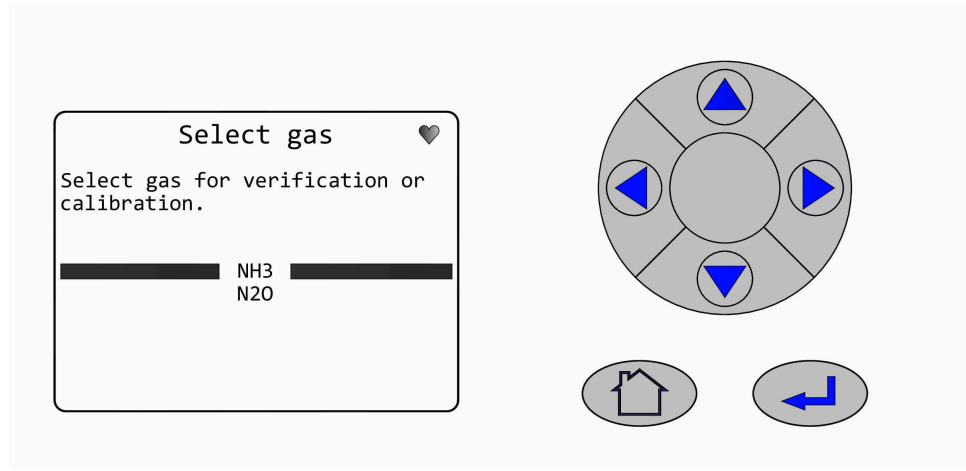

9. To manually adjust the *SPAN FACTOR*, use ▲ and ▼ to select *SPAN FACTOR*. Press ►.

Figure 6-13: Span Factor

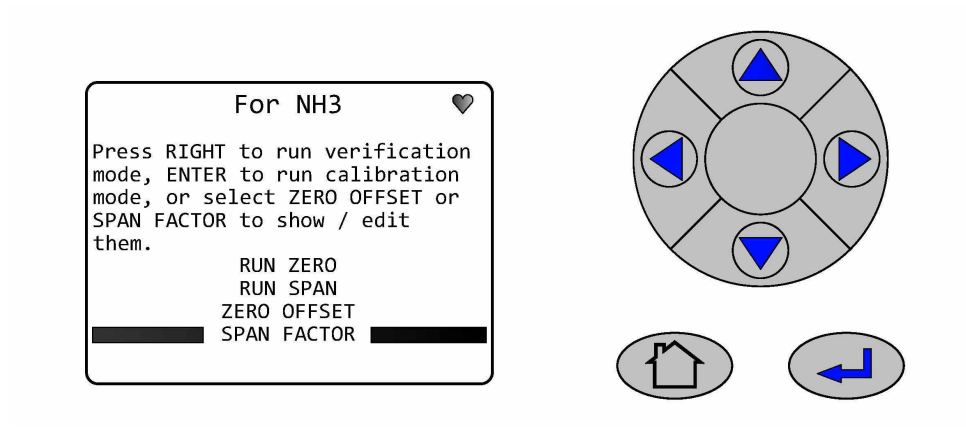





10. Use  or  or  or  as required to set the required value. Press  to confirm.

Figure 6-14: Gas Compensation Span Factor



Span calibrate

Procedure

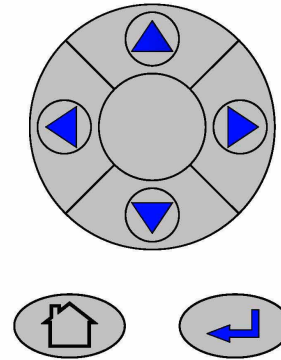
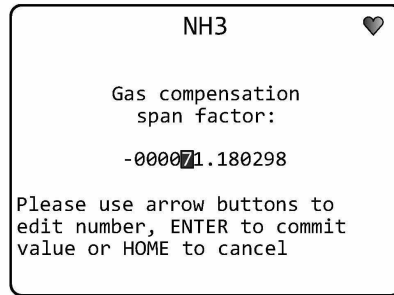
1. Use  to start the *SPAN CALIBRATION* process.

Figure 6-15: Run Span

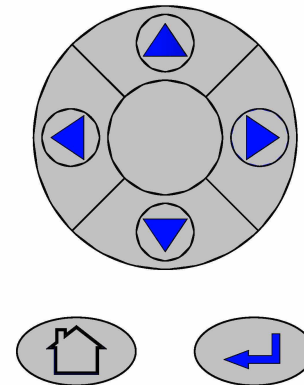
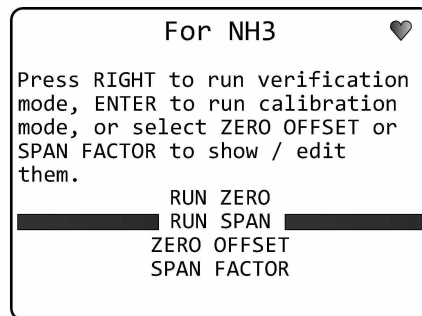

2. Use ▲ or ▼ or ◀ or ▶ as required to set the calibration value for the test cylinder.
Press ↵ to confirm.

Figure 6-16: Verify Input

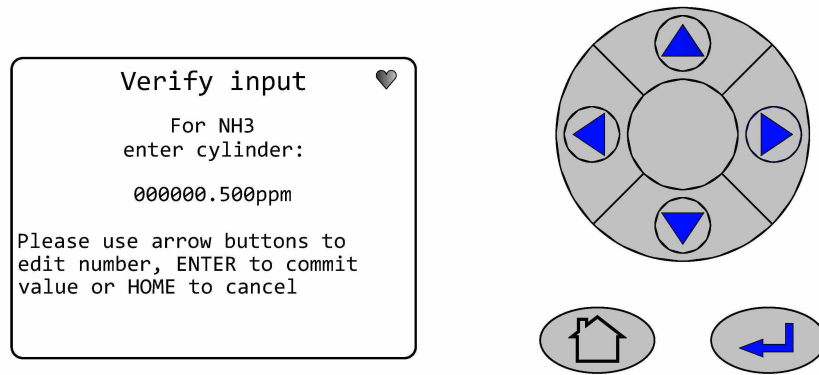
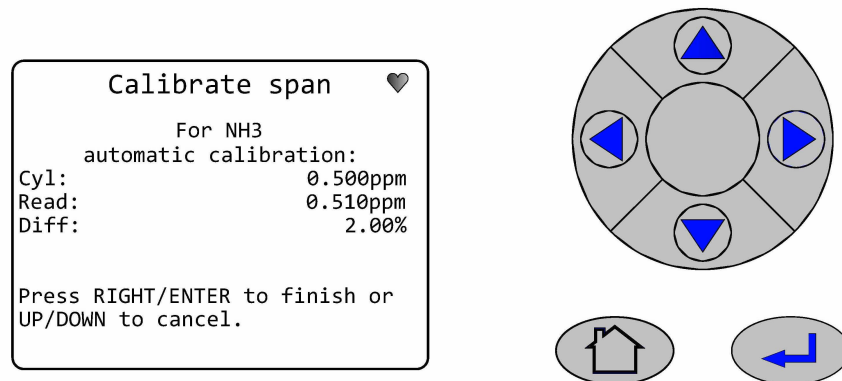

Figure 6-17: Calibrate Span Finish







3. To abort the calibration process, press  or , otherwise the analyzer will perform the **SPAN CALIBRATION**, either after waiting for the purge time, or when  or  is pressed, whichever is sooner. The result of the calibration will then be displayed, as below.

Figure 6-18: Span Calibration Result



4. Press the appropriate button.



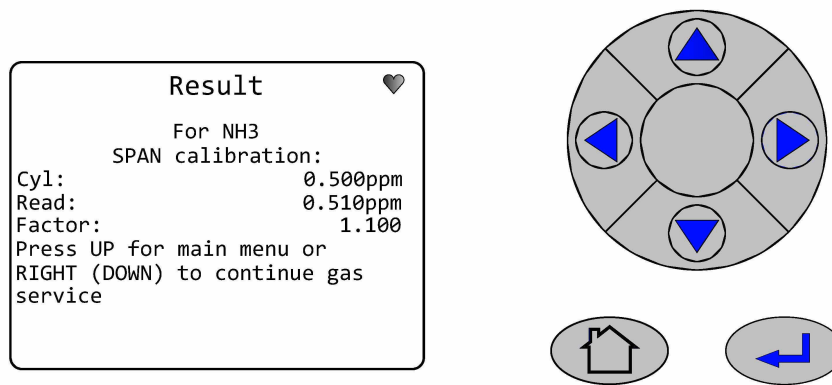

Option	Description
	To return to the <i>Gas Service</i> Screen.
	To select the Next Gas from the <i>Select Gas</i> screen.
	To return to the <i>Main Menu</i> .
	To return to the <i>Gas Sensor Main</i> screen (Figure 4-4).

Figure 6-19: Next Gas Service Finish



Change the gas service calibration settings

The gas purge time can be adjusted as follows:

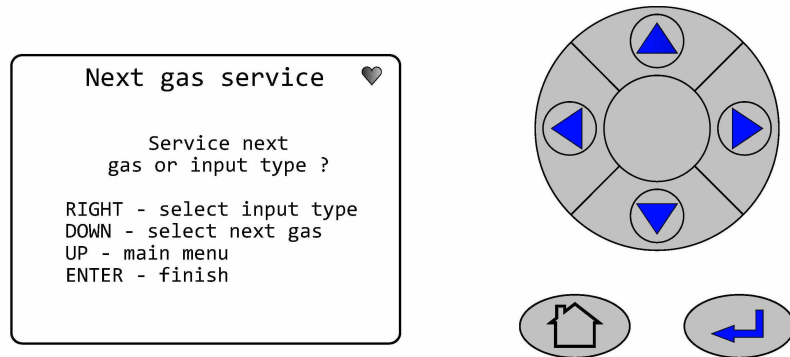
Procedure

1. Use ▲ or ▼ and select **GAS SERVICE**. Press ►.

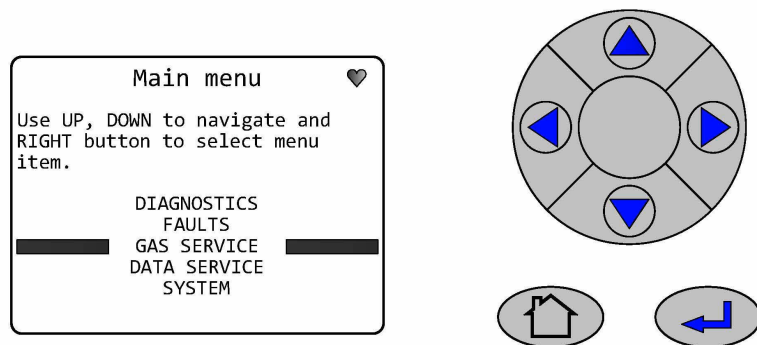

Figure 6-20: Select Gas Service

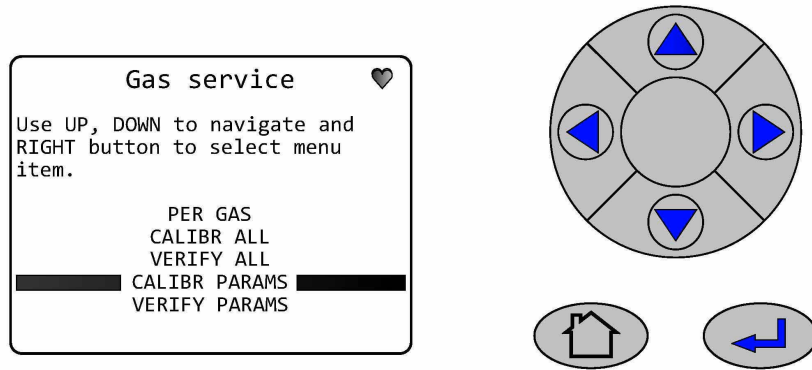

- Use  or  and select *CALIBR PARAMS*. Press .

Figure 6-21: Gas Service







- To adjust the length of time for the calibration gas to flush the cell use  or  to select *PURGE TIME*. Press .

Note

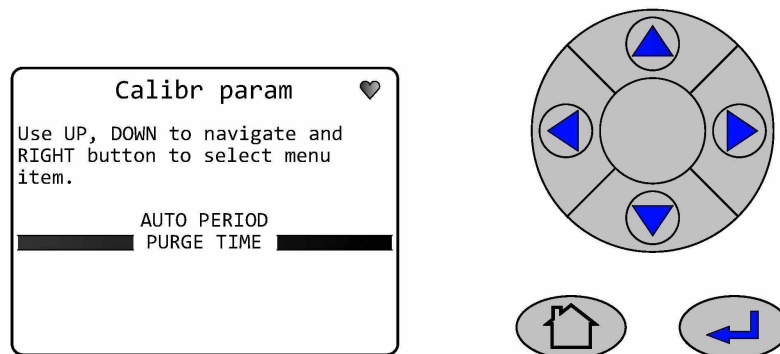
AUTO PERIOD is not available on the Rosemount CT4400.

Figure 6-22: Calibrate Parameters



- Use the  or  to select the number or duration to be changed. (seconds/minutes/hours/days).
- Use the  or  to change the number or duration value.



6. Press  to accept the change or HOME Key  to cancel.

Figure 6-23: Purge Time



6.4 Reference gas - suggested concentration ranges

Calibration gas ranges are recommended to be between 80 percent and 100 percent of the full range of the analyzer. Please contact your Rosemount Customer Care Representative if you require further assistance at (cascade.support@emerson.com).

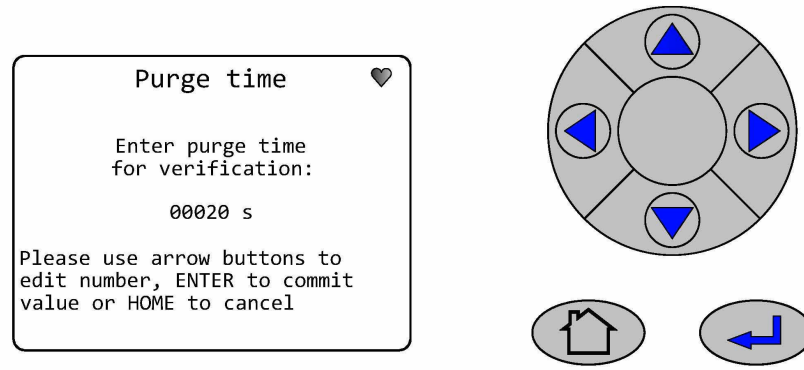
7 Troubleshooting and diagnostics

7.1 Troubleshooting, repairs, and failure diagnostics

The analyzer is specifically designed to run unattended for long periods, to automatically resolve system issues, and to recover from power failures and return to a normal working state without intervention.

This troubleshooting guide is intended to assist maintenance personnel when the analyzer has not appeared to be working normally for a period of more than five minutes. If the procedures in this chapter fail to return the analyzer to normal operations or do not identify a fault, notify your Rosemount Customer Care Representative (cascade.support@emerson.com) at which point the analyzer may require to be returned for detailed examination and fault finding at a service center.

Observe and obey all safety precautions when performing preventative maintenance on the analyzer.

Important

The troubleshooting and failure diagnosis procedures described in this chapter assume that any host equipment provided by you is fully functional. Always make sure that the host equipment is fully serviceable before performing failure diagnosis on the analyzer.

Failure diagnosis, repair, and maintenance must only be performed by:

- Maintenance engineers who have the necessary skills, and who have been authorized to perform maintenance on the analyzer.
- Emerson customer care engineers.

In all the cases described in this chapter, maintenance personnel must perform the repairs by directly replacing the faulty item with a known serviceable spare part supplied by Emerson. All other items must be repaired or replaced by the manufacturer.

CAUTION

EQUIPMENT DAMAGE

In the event of a power failure any residual sample gas should be purged from the analyzer to ensure any corrosive gas elements are not left to contaminate/degrade the internal components. Failure to do so could result in irreparable damage to the analyzer.

⚠ DANGER

ELECTRIC SHOCK

The analyzer operates using mains voltage that is dangerous to life. Make sure that the power ON/OFF switch at the rear of the panel is set to OFF and the power cable plug is removed.

The analyzer **MUST** be earthed using a grounded three core cable suitable for the rating defined in the General Characteristics ([Table 1-3](#)).

Death or personal injury may result if this is not observed.

⚠ WARNING

HEAVY ITEM

Handle the analyzer with caution during unpacking, installing, maintaining, and transporting to prevent crushing of hands, feet, or other body parts.

The analyzer weighs 33 lb (15 kg) for the half rack system and 66 lb (30 kg) for the full rack system. Rosemount recommends that the analyzer is moved by a minimum of two people when lifting and transporting the equipment.

Failure to properly handle the analyzer may cause injury to personnel, wear suitable protective gloves and protective footwear.

⚠ WARNING

FIRE AND EXPLOSION

Always lock-out/tag-out the gas handling system when shutting down the analyzer. Unauthorized operation of the gas handling system when maintenance is being performed on the analyzer or its associated pipes/hoses may result in highly flammable gas being released, causing fire or explosion.

Failure to observe this precaution will cause death, personal injury, and/or damage to persons.

⚠ WARNING

HAZARDOUS SUBSTANCES

The analyzer may contain hazardous substances. Always handle the analyzer assemblies and components with extreme caution.

Gas handling components within the analyzer will contain particulate matter residue from the sample gases. Over the life of the analyzer, the concentration of the particulate matter will become enriched within the gas handling components.

When performing repairs or maintenance on the analyzer:

- Handle used gas handling components with extreme caution.
- Avoid direct skin contact with used gas handling components.
- Do not smoke, drink, or eat in the work area.
- Wear goggles or eye shields.
- Wear a suitable face mask to protect against inhalation of particulate matter.
- Do not wet fingers, eyes, or any exposed skin.
- Pack used gas handling components for disposal in sealed packaging and label them *Contaminated*.
- Dispose of contaminated items as hazardous material according to the applicable local, national, or international health and safety regulations and pollution regulations.

7.2 Using the Built-In-Self Test (BIST) fault diagnostics

The analyzer has a Built-In-Self-Test (BIST) function that can be used to perform failure diagnosis of some functions other than a complete failure of the equipment. The BIST is accessed and controlled through the display controller mounted on the front panel of the analyzer. The BIST runs in the background when the analyzer is operating and continuously monitors the analyzer for faults.

If the BIST detects a fault the **STATUS** display in the bottom left-hand corner of the **Main Screen** ([Faults screen selection](#)) will change from **OK** to a flashing **X**.

Analysis of the fault detected can be performed using the indicated [Fault menu](#) screen or the [Diagnostics menu screen](#).

7.2.1 Fault menu

The BIST function can be used to perform failure diagnosis of some functions in situations where there is a fault other than a complete failure of the equipment. The BIST is accessed and controlled through the **FAULTS** screen accessed from the **Main Menu** screen mounted on the front panel. This gives the operator access to any assess any Faults that the analyzer has detected in the systems being monitored.

Faults screen selection

Procedure

1. Where more Faults are available than can be displayed on the screen use the ▲ or ▼ keys to scroll up or down onto the next page. The screen will continually wrap around until the Fault required is highlighted.
2. Pressing the **Forward** key ► will move to the next screen where available as shown in the *Diagnostics/Faults* example below. Pressing the screen **Refresh** key ↶ at any time will refresh the current display screen if required by the operator. Pressing the **Back** key ◀ will return to the previous screen. Pressing the **Home** key 🏠 at any time will return to the *Main Menu* screen.
3. You can see the STATUS information from either the *Gas Sensor Main* screen (Figure 4-4) or the *Pressure and Temperature* screen (Figure 4-5).
 - When the analyzer is running correctly, the STATUS displays Running and OK.
 - If a fault is detected the STATUS display in the bottom left-hand corner of the screen changes from OK to a flashing X.
4. Pressing the **Forward** key ► will move to the *Main menu* screen.

Figure 7-1: Faults Screen Selection

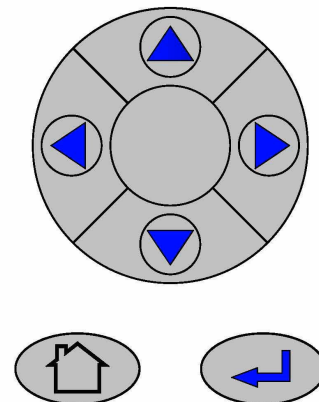
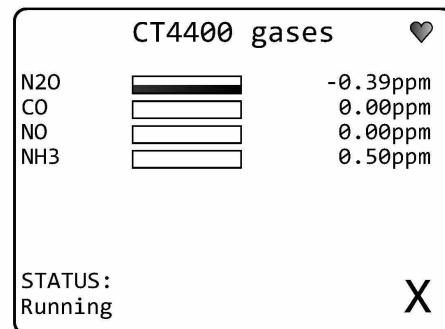

5. Scroll ▲ or ▼ and select *Faults*. Press ►.

Figure 7-2: Main Menu - Faults Screen

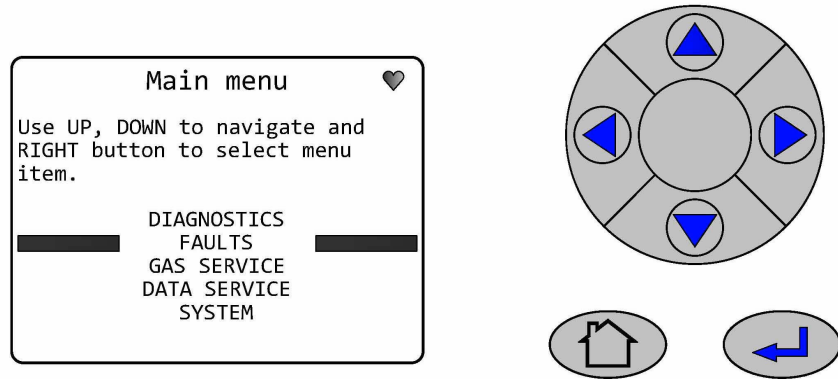

6. Scroll ▼ and select the component to obtain details on the next screen. Press ► to obtain details about the fault

Figure 7-3: Faults Selection Screen

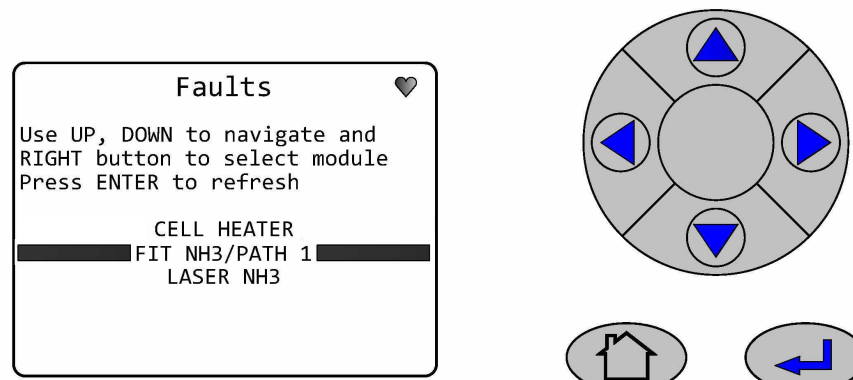

7. The example screen shows the `Fit6/Path2` status is `XShift Error`. The `XShift` value is not within the defined tolerance. When rectified, the status will change to `OK`.

Figure 7-4: Fault Status Details Screen

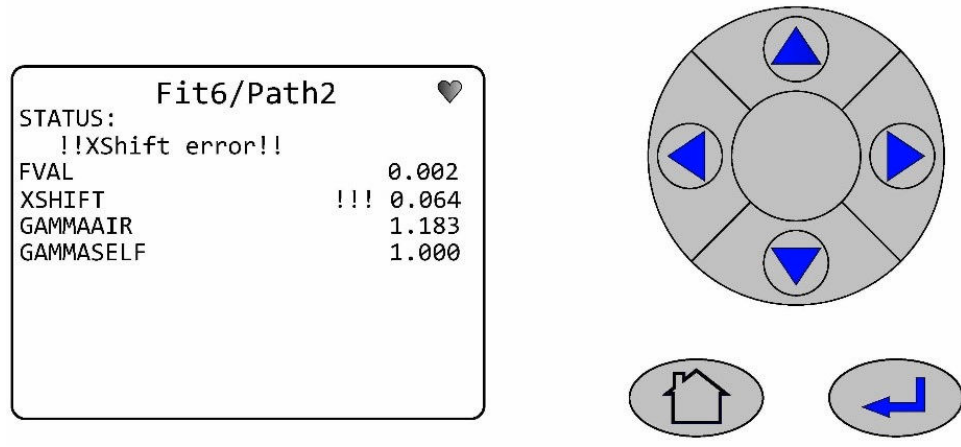

8. Examine the data shown on the corresponding *Faults* screen to determine if a component has failed or if it is operating outside of its correct parameters.
9. Contact your Emerson Customer Care Representative (cascade.support@emerson.com) if you need further assistance with a component's Fault Status.

7.2.2 Diagnostics menu screen

The *Diagnostics* screen lists those main components of the analyzer where problems can be diagnosed using the BIST system. The Diagnostics screen also enables you to check on the status and, where appropriate, the values of any of the listed components.

The *Diagnostics* menu screen can be accessed from the *Main Menu* screen.

This gives the operator access to a number of options when checking the overall health of the analyzer.

Procedure

1. Where more options are available than can be displayed on the screen use the or keys to scroll up or down onto the next page. The screen will continually wrap around until the option required is highlighted.
2. Pressing the Forward key will move to the next screen where available as shown in the Diagnostics/Config example below. Pressing the screen Refresh key at any time will refresh the current display screen if required by the operator.

CONFIG gives the status of the analyzer *CONFIGURATION* file.
SENSOR gives the status of the analyzer *SENSOR(s)* engine.

LASER XXX	provides the operator with additional information on each LASER that the analyzer has been set up to monitor.
PATH XXX	provides the operator with information on the laser PATH for each gas being monitored by the analyzer.
FIT XXX/PATH XXX	provides the operator with information on the FIT/PATH for each gas being monitored confirming if the gas concentration measured is within specification.
BEKA RS232	NOT AN OPERATOR REQUIRED OPTION.
CELL HEATER	provides the operator with information on the CELL HEATER .
XSTREAM	NOT AN OPERATOR REQUIRED OPTION.





- Pressing the Back key  will return to the previous screen. Pressing the Home key  at any time will return to the **Main Menu** screen.
- Scroll  or  and select **DIAGNOSTICS**. Press .

Figure 7-5: Main Menu



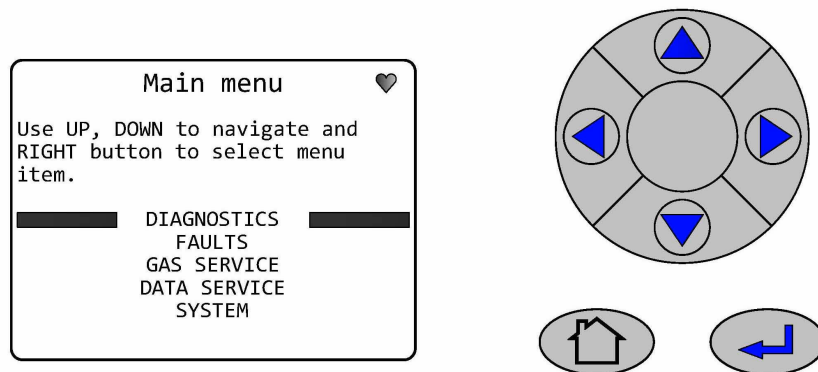

Example 1: Use  or  to view all the options available. Select the Item required to obtain further details on the next screen. Press .

Figure 7-6: Diagnostics Screen - CONFIG Selection



The example screen below shows the **CONFIG** option for the analyzer has been selected and the current **Status** is OK.

Figure 7-7: Config Status

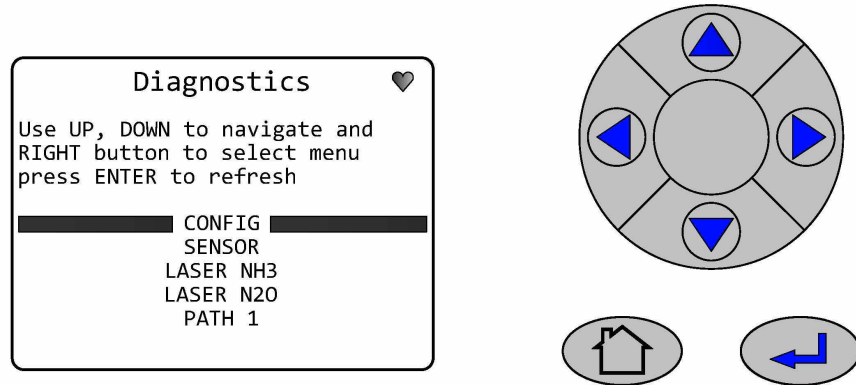
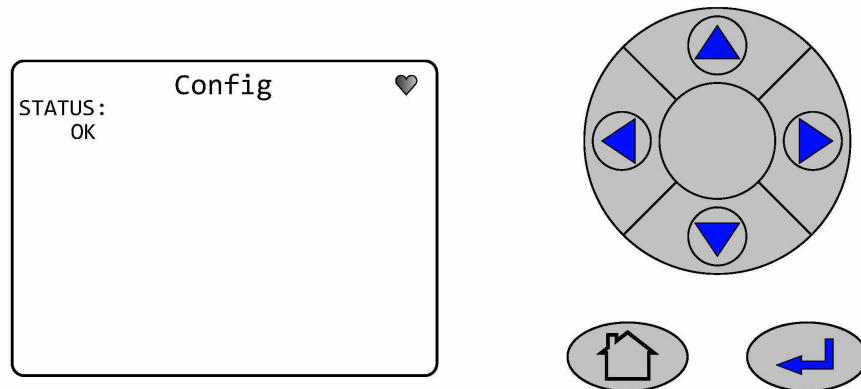



Example 2: Use  or  to view all the options available. Select the Item required to obtain further details on the next screen. Press .

Figure 7-8: Diagnostics - Component Selection Screen



The example screen above shows the *Laser 1* option for the analyzer has been selected and the current *Status* is OK.

Figure 7-9: Laser 1 Status

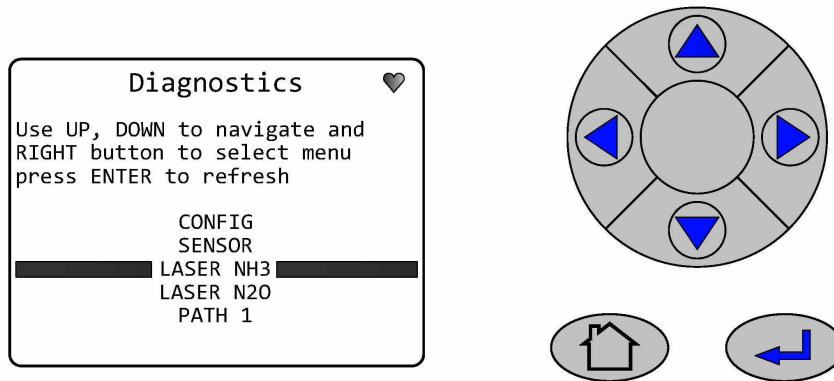
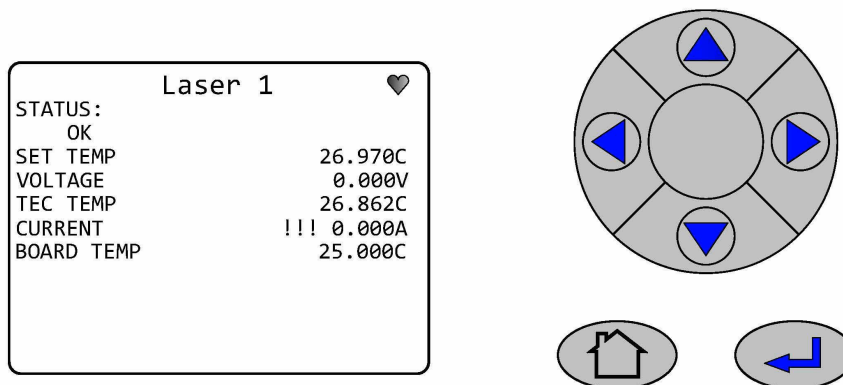

Note

Additional operating information has been provided for this option.

7.3 Configuring the 4-20mA outputs

The *DATA SERVICE* menu screen can be accessed from the *Main Menu* screen.

This gives the operator access to set the 4-20 mA output ranges for the gas being analyzed.

Procedure

1. Where more options are available than can be displayed on the screen use the ▲ or ▼ keys to scroll up or down onto the next page. The screen will continually wrap around until the option required is highlighted.
2. Pressing the **Forward key** ► will move to the next screen where available as shown in the *Data Service/Analog Ranges* example below.
3. Pressing the screen **Refresh key** ↺ at any time will refresh the current display screen if required by the operator.

ANALOG RANGES allows the operator to set the upper and lower limits for the 4-20 mA measurement output.

USB DATA DUMP NOT an option available for the Rosemount CT4400 analyzer.

TFTP TRANSFER NOT an option available on the Rosemount CT4400 analyzer.

4. Pressing the **Back key** ◀ will return to the previous screen.
5. Pressing the **Home key** 🏠 at any time will return to the *Main Menu* screen.
6. Scroll ▲ or ▼ and select **DATA SERVICE**. Press ►.

Figure 7-10: Main Menu - Data Service

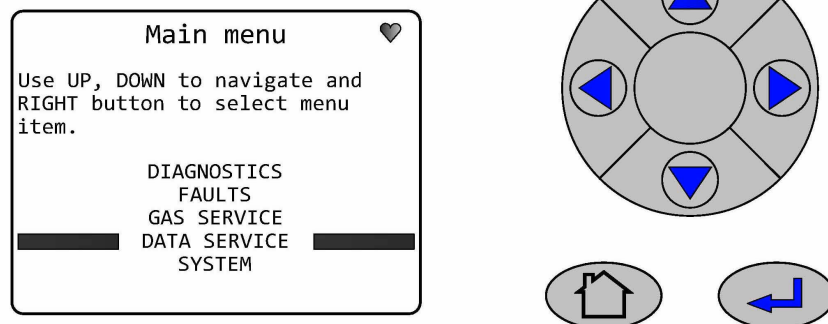

7. Scroll ▲ or ▼ and select **ANALOG RANGES**. Press ►.

Figure 7-11: Data Service - Analog Ranges

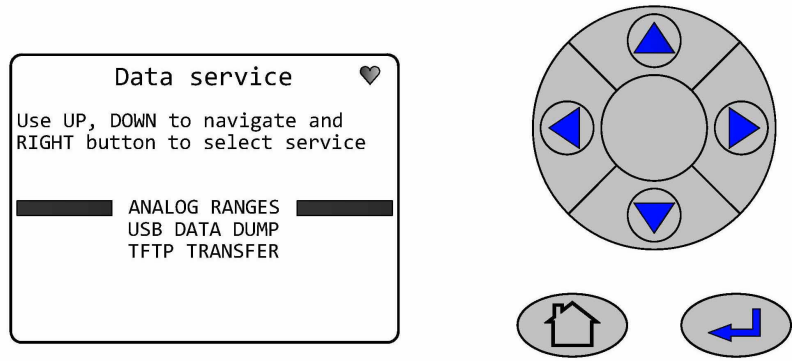

8. Scroll ▲ or ▼ and select from the list of gases being tested. Press ►.

Figure 7-12: Analog Range Gas Selection Screen

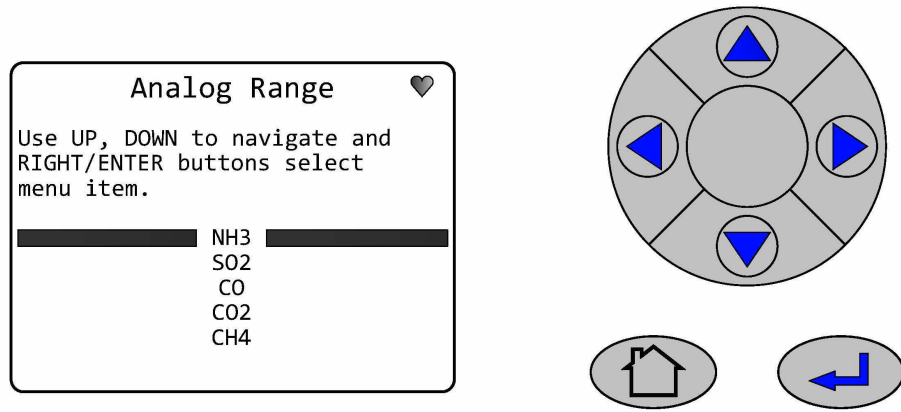

9. Select the MIN option. Press ►.

Figure 7-13: MIN Option Selected

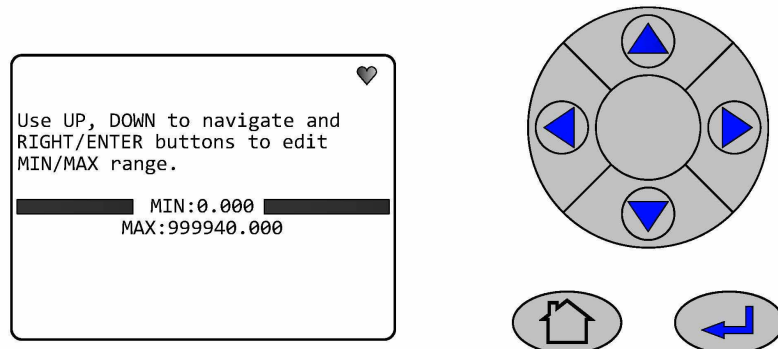





10. Use the  or  to select the number to be changed.
11. Use the  or  to change the number value.

Figure 7-14: Minimum Limit



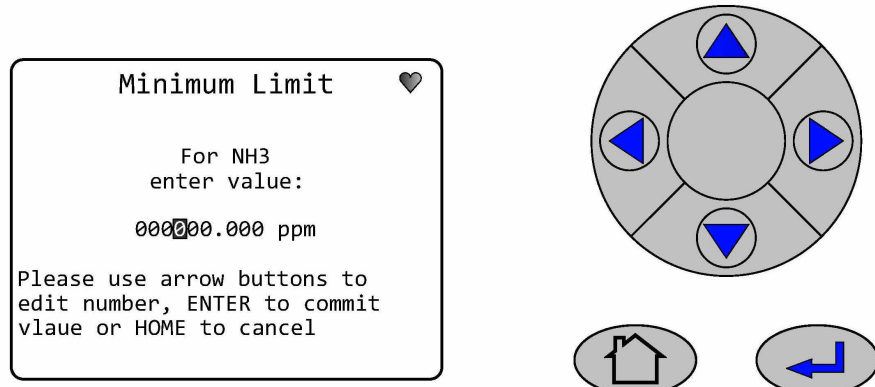

12. Press  to accept the change Home key  to cancel.
13. Select the MAX option. Press .

Figure 7-15: MAX Option Selected







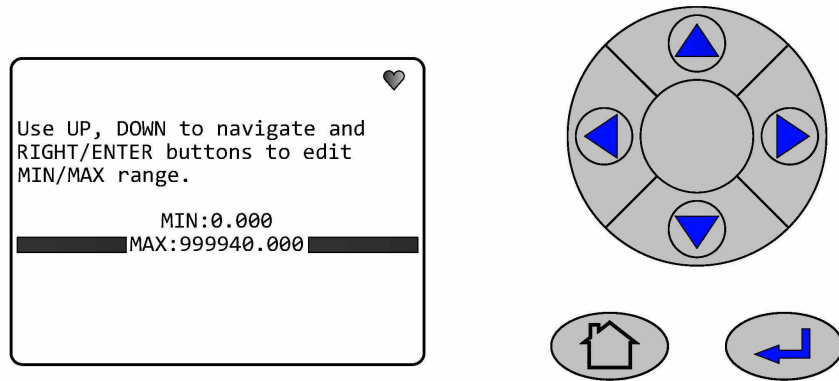

14. Use the  or  to select the number to be changed.
15. Use the  or  to change the number value.

Figure 7-16: Maximum Limit

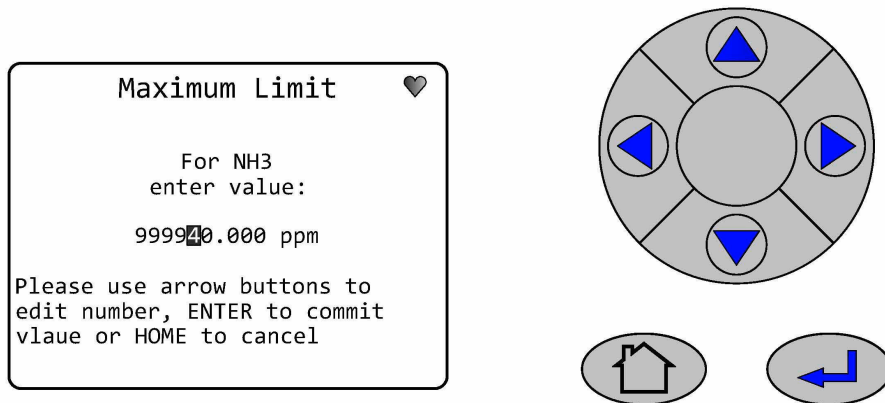

16. Press  to accept the change **Home** key  to cancel.

7.4 Visual examination

A visual examination of the analyzer is recommended as the next step in failure diagnosis if the BIST fails to identify the problem.

⚠ DANGER

ELECTRIC SHOCK

The analyzer operates using mains voltage that is dangerous to life. Make sure that the power ON/OFF switch at the rear of the panel is set to OFF and the power cable plug is removed.

The analyzer **MUST** be earthed using a grounded three core cable suitable for the rating defined in the General Characteristics ([Table 1-3](#)).

Death or personal injury may result if this is not observed.

Procedure

1. Power down the analyzer and allow it to cool.
2. Visually examine the exterior of the analyzer for signs of damage.
3. Perform a visual inspection of the electrical and gas connections on the rear panel of the analyzer.
4. If any loose connections are found tighten as required.

7.5 Failure diagnostics

If the BIST and the visual examination fail to identify the fault, perform the failure diagnostics and recommended actions.

7.5.1 Gas reading abnormal

Potential cause

Gas reading abnormal

Recommended action

1. Check measurement validity flag.
2. Reading invalid.
3. refer to Measurement invalid flag.

Potential cause

Gas reading abnormal

Recommended action

1. Check measurement validity flag.
2. Reading valid.

3. Perform a new Zero and Span calibration to ensure calibration factors are correct.
4. Readings return to normal.
5. Sensor required calibration.

Potential cause

Gas reading abnormal

Recommended action

1. Check measurement validity flag.
2. Reading valid.
3. Perform a new Zero and Span calibration to ensure calibration factors are correct.
4. Abnormal readings persist.
5. Cause Unknown.
6. Contact (cascade.support@emerson.com).

Related information

Measurement invalid flag.

7.5.2 Calibration/validation drift

Potential cause

Sensor reading invalid.

Recommended action

1. Check measurement validity flag.
2. Reading is invalid.
3. refer to Measurement invalid flag.

Potential cause

Sensor required calibration.

Recommended action

1. Check measurement validity flag.
2. Reading is valid.
3. Perform a new Zero and Span calibration to ensure calibration factors are correct.
4. Readings return to normal.
5. Sensor required calibration.

Potential cause

Sensor does not require calibration.

Recommended action

1. Check measurement validity flag.
2. Reading is valid.

3. Perform a new Zero and Span calibration to ensure calibration factors are correct.
4. Readings do not return to normal.
5. Check calibration cylinder.
6. Calibration cylinder near empty.
7. Replace calibration cylinder.
8. Readings return to normal.
9. Cylinder was empty.

Potential cause

Calibration cylinder empty.

Recommended action

1. Check measurement validity flag.
2. Reading is valid.
3. Perform a new Zero and Span calibration to ensure calibration factors are correct.
4. Readings do not return to normal.
5. Check calibration cylinder.
6. Calibration cylinder near empty.
7. Replace calibration cylinder.
8. Readings do not return to normal.
9. Check the calibration pipework.
10. Pipework damaged.
11. Replace pipework.
12. Readings return to normal.
13. Pipework was damaged.

Potential cause

Pipework damaged empty.

Recommended action

1. Check measurement validity flag.
2. Reading is valid.
3. Perform a new Zero and Span calibration to ensure calibration factors are correct.
4. Readings do not return to normal.
5. Check calibration cylinder.
6. Calibration cylinder near empty.
7. Replace calibration cylinder.
8. Readings do not return to normal.
9. Check the calibration pipework.
10. Pipework damaged.
11. Replace pipework.
12. Readings do not return to normal.

13. Cause Unknown.
14. Contact (cascade.support@emerson.com).

Related information

Measurement invalid flag

7.5.3 Measurement invalid flag

Potential cause

Pressure or temperature is out of range.

Recommended actions

1. Check display controller to assess which measurements are invalid.
2. All gas readouts are invalid.
3. Use the display controller to check pressure and cell temperature.
4. Pressure and temperature are both within range.
5. Hardware failure.
6. Contact (cascade.support@emerson.com).

Potential cause

Pressure or temperature is out of range.

Recommended action

1. Check display controller to assess which measurements are invalid.
2. All gas readouts are invalid.
3. Use the display controller to check pressure and cell temperature.
4. Pressure is out of range.
5. Refer to Analysis cell pressure out of range.

Potential cause

Pressure or temperature is out of range.

Recommended action

1. One gas readout is invalid.
2. Refer to Single gas reading invalid

Related information

Single gas reading invalid

Analysis cell pressure out of range

7.5.4 Single gas reading invalid

Potential cause

Gas reading invalid

Recommended actions

1. Check which gas.
2. Check fault readings.
3. Fault reading active.
4. Use Fault to access further diagnostic information
5. Contact (cascade.support@emerson.com).

Potential cause

Gas reading invalid

Recommended action

1. Check which gas.
2. Check fault readings.
3. Fault reading not displayed.
4. Contact (cascade.support@emerson.com).

7.5.5 Analysis cell pressure out of range

Potential cause

Pressure was out of range.

Recommended action

1. Adjust inlet valve to change pressure.
2. Pressure returns to normal.
3. No further action required.

Potential cause

Pressure was out of range.

Recommended action

1. Adjust inlet valve to change pressure.
2. If pressure is unstable or impossible to adjust.
3. Contact (cascade.support@emerson.com).

7.5.6 Sensor frozen or unresponsive

Potential cause

Computer freeze-up or connection failure.

Recommended actions

1. Attempt a reboot.
2. System reboots successfully.
3. Contact (cascade.support@emerson.com).

Potential cause

PC or HMI failure.

Recommended actions

1. Attempt a reboot.
2. System does not reboot.
3. Contact Cascade (cascade.support@emerson.com).

7.5.7 Other error not covered in other sections

Potential cause

Unknown

Recommended actions

Contact Cascade (cascade.support@emerson.com).

7.6 Replacing the power socket fuses

The analyzer contains two external fuses located in the power socket attached to the rear panel.

⚠ DANGER

ELECTRIC SHOCK

The analyzer operates using mains voltage that is dangerous to life. Make sure that the power ON/OFF switch at the rear of the panel is set to OFF and the power cable plug is removed.

The analyzer **MUST** be earthed using a grounded three core cable suitable for the rating defined in the General Characteristics ([Table 1-3](#)).

Death or personal injury may result if this is not observed.

Procedure

1. Turn the **ON/OFF** switch on the back panel to **OFF**.
2. Disconnect the external power supply from the power socket.
3. Allow the analyzer to cool.

⚠ WARNING

ELECTRIC SHOCK

Fuses **MUST** only be replaced with the fuses of the same type and rating as those being removed (6.3A 250 VAC ceramic cartridge fuse, 5x20 mm, Speed F. IEC 60127 compliant). Failure to do so may result in personnel injury and or equipment damage.

4. Carefully lever open the fuse cover (B) to gain access to the fuses (C).

Figure 7-17: Power Socket Fuses

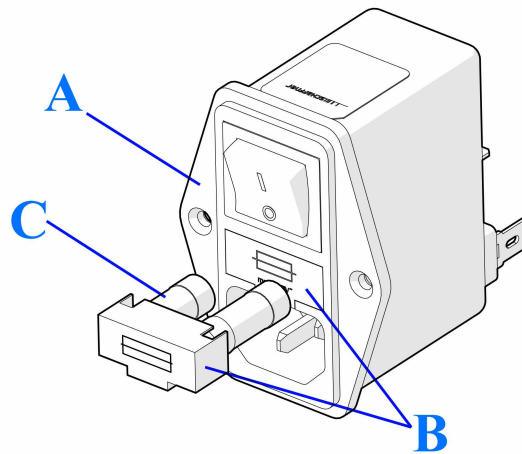

- A. Power socket
- B. Fuse cover/fuse holder
- C. Fuse

5. Remove the fuse (C) from the holder (B).
6. Fit a new fuse (C), of the same type and rating, into the fuse holder (B) (6.3A 250 VAC ceramic cartridge fuse, 5x20 mm, Speed F. IEC 60127 compliant).
7. Repeat for the second fuse.
8. Fully push the fuse holder (B) back into position in the power socket (A).
9. Reconnect the external power supply to the power socket on the back panel.
10. Start up the analyzer by turning the *ON/OFF* switch on the back panel to the *ON* position.
11. The analyzer will automatically begin the startup process.

7.7 Cleaning the analysis cell mirrors

Cleaning the analysis cell mirrors will only be required if the sample gas is not conditioned in accordance with gas requirements defined in the General characteristics [Table 1-3](#) and the Environmental characteristics [Table 1-4](#).

For example, it is possible that the mirrors inside the cell may become contaminated if contaminants are carried into the cell in water droplets in the gas being sampled if it is not conditioned correctly the mirrors would then require to be cleaned to remove any contamination from them.

The mirror surface is highly reflective and susceptible to damage if cleaned incorrectly or excessively. Damage to the reflective coating on the mirrors **WILL** affect the analyzer performance. Mirrors found to be damaged due to excessive cleaning or from corrosive material residue will invalidate the warranty for the analyzer.

If the cell mirrors must be cleaned the analysis cell must only be opened in a **CLEAN/DRY/DUST FREE** area to prevent further contamination.

Observe all safety precautions before starting this procedure.

⚠ DANGER

ELECTRIC SHOCK

The analyzer operates using mains voltage that is dangerous to life. Make sure that the power ON/OFF switch at the rear of the panel is set to OFF and the power cable plug is removed.

The analyzer **MUST** be earthed using a grounded three core cable suitable for the rating defined in the General Characteristics ([Table 1-3](#)).

Death or personal injury may result if this is not observed.

⚠ DANGER

FAILURE TO LOCK-OUT THE GAS HANDLING SYSTEM

Always lock out the gas handling system when shutting down the analyzer. Unauthorized operation of the gas handling system when maintenance is being performed on the analyzer or its associated pipes/hoses may result in highly flammable gas being released, causing fire or explosion.

Death or personal injury may result if this is not observed.

⚠ DANGER

FAILURE TO VENT SAMPLE GAS

The sample gas in the system must be vented to prevent fire or explosion during maintenance and to prevent damage to the analyzer during startup.

The sample gas in the pipes leading to the analyzer must be purged to prevent hazards to personnel during maintenance. Purging the sample gas must be done in accordance with the safe working procedures for the site.

Allow the analyzer and system for returning the sample gas to run for five minutes to allow any sample gas in the system to be returned to the exhaust.

⚠ WARNING

HEAVY ITEM

Handle the analyzer with caution during unpacking, installing, maintaining, and transporting to prevent crushing of hands, feet, or other body parts.

The analyzer weighs 33 lb (15 kg) for the half rack system and 66 lb (30 kg) for the full rack system. Rosemount recommends that the analyzer is moved by a minimum of two people when lifting and transporting the equipment.

Failure to properly handle the analyzer may cause injury to personnel, wear suitable protective gloves and protective footwear.

Procedure

1. Turn the **ON/OFF** switch on the back panel to **OFF**.
2. Disconnect the external power supply from the power socket.
3. **VERIFY** the sample gas handling system has been shut down and locked-out/tagged-out.
4. The sample gas supply in the system **MUST** be vented to prevent fire or explosion during maintenance.
5. Allow the analyzer to cool.
6. Disconnect all external cables. (Tag if necessary).
7. Disconnect, cap and label the tubing at the back of the analyzer connecting to the sample handling system.
8. Remove the analyzer from the rack and place on a flat, stable surface that can accommodate the weight of 33 lb (15kg) for the half rack and 66 lb (30 kg) for the full rack system. This step requires two people to lift and transport the analyzer.

Figure 7-18: Removing the Top Cover

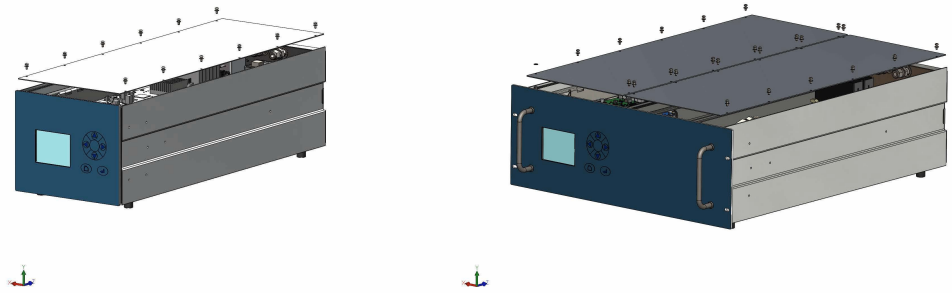

9. The area selected **MUST** be clean and dust free.
10. Remove and retain the 12 off (24 off) M3 button head screws and plain washers used to secure the top cover(s).
11. Lift the top cover(s) clear of the chassis assembly.
12. Examine the cover for signs of physical damage, inside and out.
13. Locate the two cam lock screws securing the hinged PCB tray, rotate a $\frac{1}{4}$ turn to release.

Figure 7-19: Releasing the PCB Tray

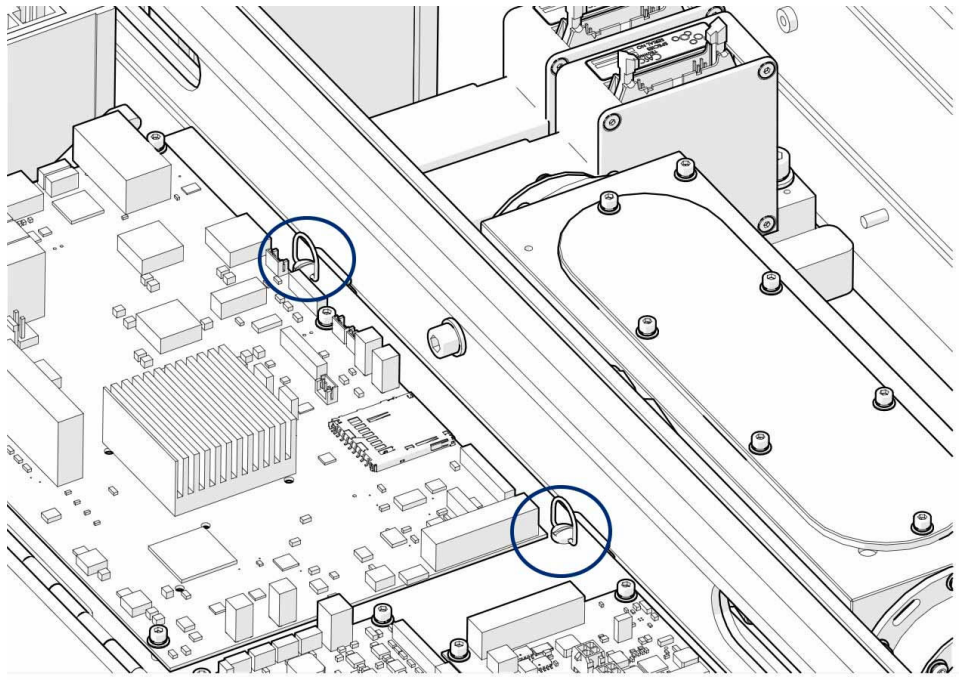

14. Carefully swing open the hinged PCB tray to gain access to the analysis cell. The second analysis cell fitted in a Full rack system was fully accessible once the outer cover was removed.

Figure 7-20: Accessing the Analysis Cell

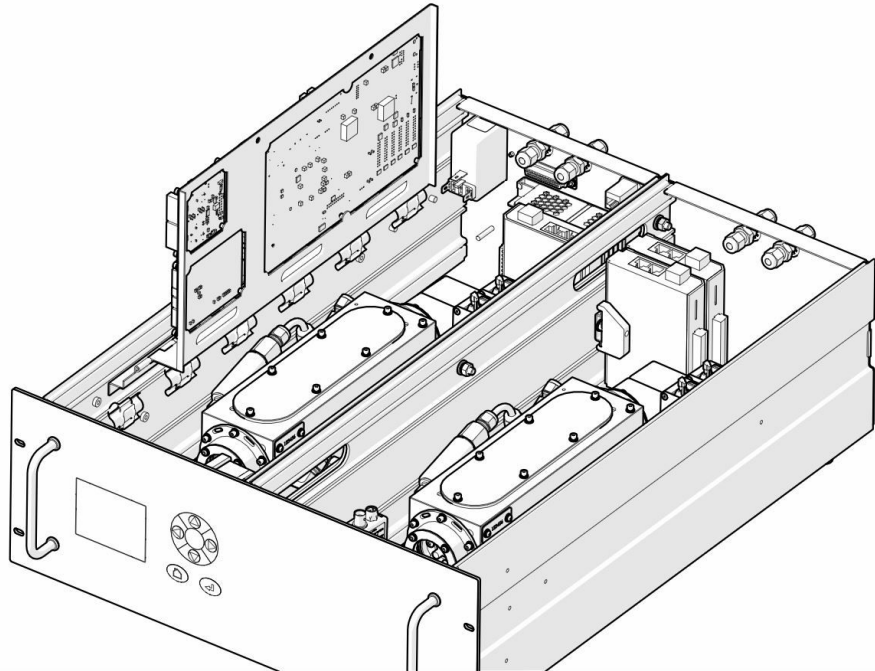

15. Using an Allen key, remove and retain the six socket head cap screws and washers (D) used to secure the cell cover (C) on the analysis cell (B). Care **MUST** be taken to ensure the O-Ring (A) does not get damaged.
16. It may be necessary to use a small flat blade screwdriver to lever the cell cover off. With the cover removed, the mirrors are now exposed.

Figure 7-21: Opening the Analysis Cell

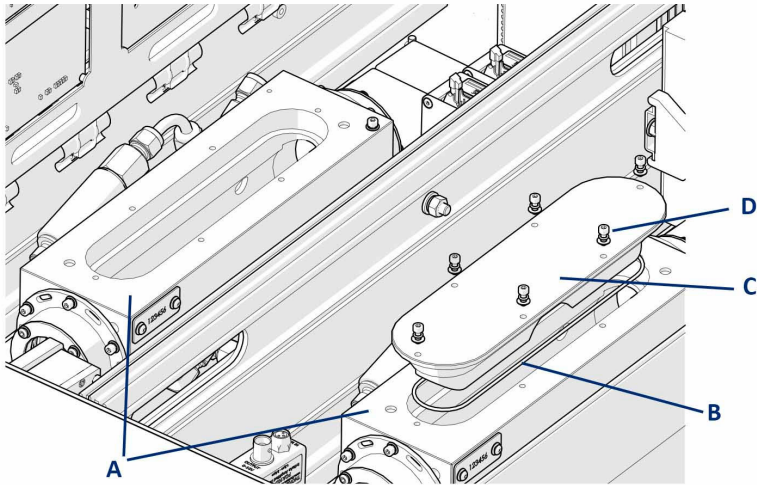

- A. Analysis cell
- B. O-ring
- C. Cell cover
- D. Fasteners

17. Clean the mirrors by applying a small quantity of reagent grade methanol to a clean, dry, lens tissue and then gently wiping the mirrors with the lens tissue. Care **MUST** be taken not to apply pressure to the lens during this operation to prevent scratching the reflective surface.

Scratches to the mirror surface **WILL** affect the ability for the analyzer to operate and **WILL NOT** be covered by the warranty for the analyzer. (If reagent grade methanol is unavailable, then reagent grade IPA may be used instead.)

Figure 7-22: Cleaning the Lens

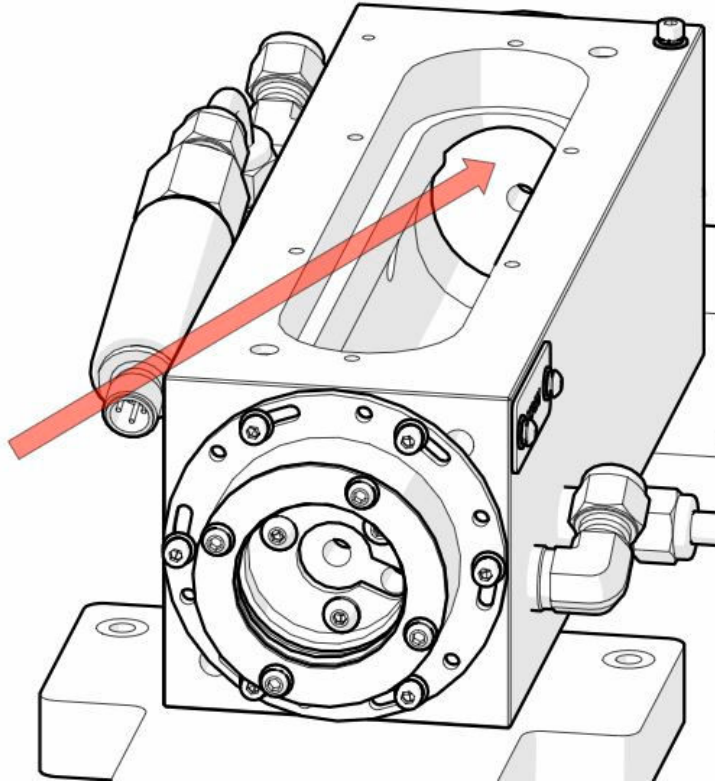

NOTICE

The flow of gas through the cell means that any water droplets introduced into the system will travel through the cell to the front mirror; therefore, it is the front mirror that is more likely to be contaminated. The mirrors are coated with enhanced nickel and should be clean and reflective. Cleaning the mirrors with methanol may not visibly improve the mirror surface but should improve reflectivity in the mid-infrared band used by the lasers.

18. Refit the cell cover (C) onto the analysis cell (B) and secure with the six socket head cap screws and washers (D) removed previously.
19. Close the hinged PCB tray and secure in position using the two cam lock screws.
20. Refit the top cover and reinstall the analyzer in the rack.

8 Shutdown procedure

This chapter describes the procedure to be followed when shutting down the analyzer.

⚠ DANGER

ELECTRIC SHOCK

The analyzer operates using mains voltage that is dangerous to life. Make sure that the power ON/OFF switch at the rear of the panel is set to OFF and the power cable plug is removed.

The analyzer **MUST** be earthed using a grounded three core cable suitable for the rating defined in the General Characteristics ([Table 1-3](#)).

Death or personal injury may result if this is not observed.

⚠ DANGER

FAILURE TO LOCK-OUT THE GAS HANDLING SYSTEM

Always lock out the gas handling system when shutting down the analyzer. Unauthorized operation of the gas handling system when maintenance is being performed on the analyzer or its associated pipes/hoses may result in highly flammable gas being released, causing fire or explosion.

Death or personal injury may result if this is not observed.

⚠ DANGER

FAILURE TO VENT SAMPLE GAS

The sample gas in the system must be vented to prevent fire or explosion during maintenance and to prevent damage to the analyzer during startup.

The sample gas in the pipes leading to the analyzer must be purged to prevent hazards to personnel during maintenance. Purging the sample gas must be done in accordance with the safe working procedures for the site.

Allow the analyzer and system for returning the sample gas to run for five minutes to allow any sample gas in the system to be returned to the exhaust.

⚠ CAUTION

EQUIPMENT DAMAGE

Always follow this shutdown procedure. Damage to the analyzer may result from a failure to follow this procedure.

The analyzer normally operates continuously. It should only be necessary to shut down the analyzer in the following circumstances:

- In order to perform repairs or maintenance on the analyzer.
- When the analyzer has to be switched off as part of a plant shutdown or plant maintenance.

Use the display controller to perform the shutdown procedure.

Operation of the analyzer is controlled through the display controller located on the front panel of the analyzer.

NOTICE

The gas concentrations shown in the following screenshots may be different from those shown in your particular analyzer. The screenshots indicate the functionality of the software, which is the same regardless of the gases or gas concentrations being measured.

Procedure

1. Shut down the gas handling system that conditions the sample gas and feeds it to the analyzer. **Lock-out the gas handling system to prevent** its unauthorized operation during maintenance, which could cause an escape of gas.

⚠ WARNING

HIGH PRESSURE GAS AND AIR

The gas supply operates at a pressure that can cause injury, e.g., damage to eyes and skin punctures from debris blown by high pressure gas or compressed air.

2. Purge any sample gas in the pipe/tube from the gas handling system to the analyzer using factory air or a regulated nitrogen supply.
3. Allow the analyzer to run for five minutes with the purge gas connected, so that any sample gas in the analyzer is vented to the exhaust.
4. Use the display controller on the front of the analyzer to perform the shutdown process.
5. On the display controller, check that the gas concentration reads 0 ppm or 0% before stopping the purge gas.
6. Turn off the purge gas supply to the analyzer. **Lock-out the purge** to prevent its unauthorized operation.
7. The *Shutdown* procedure can be started as follows.
The **SYSTEM** menu screen can be accessed from the **Main Menu** screen.

This gives the operator access to the Shutdown option for the analyzer which will close the software. The other options are factory menus that the operator **WILL NOT** need to access but are available for a Rosemount service technician during any planned future maintenance.

8. Where more options are available than can be displayed on the screen use the ▲ or ▼ keys to scroll up or down onto the next page. The screen will continually wrap around until the option required is highlighted.
9. Pressing the **Forward** key ► will move to the next screen where available as shown in the **Data Service/Shutdown** example below. Pressing the screen **Refresh** key ↶ at any time will refresh the current display screen if required by the operator.

SAVE CONFIG	NOT AN OPERATOR OPTION - saves the current configuration to the SD card.
SHUTDOWN	allows the OPERATOR to shutdown the software in a controlled manner.
SHOW VERSIONS	displays the software version installed on the analyzer.
NETWORK INFO	NOT AN OPERATOR OPTION – displays the network information.
CHANGE IP ADDRESS	NOT AN OPERATOR OPTION – displays one of the IP address.
10. Pressing the Back key ◀ will return to the previous screen.
11. Pressing the Home key 🏠 at any time will return to the **Main Menu** screen.
12. Press ▲ or ▼ and select **SYSTEM**. Press ►.

Figure 8-1: Main Menu

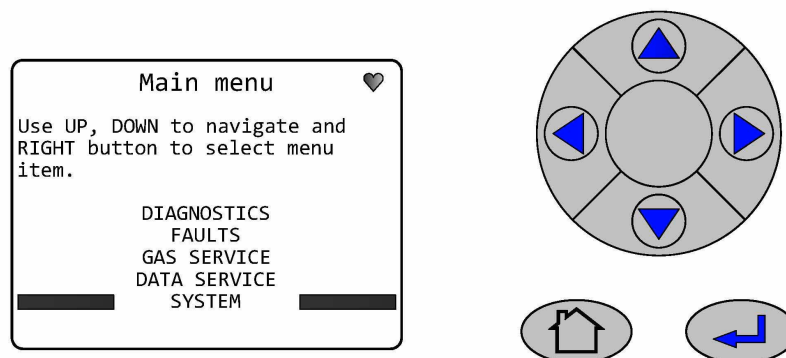



13. Press  or  and select *SHUTDOWN*. Press .

Figure 8-2: System



14. Press  to accept. Press  to reject.

Figure 8-3: Shutdown

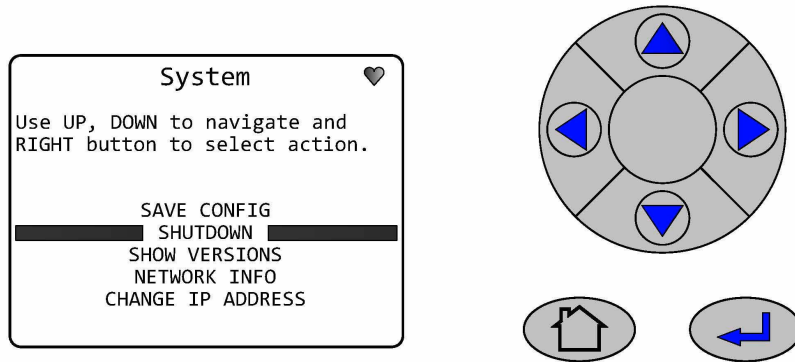
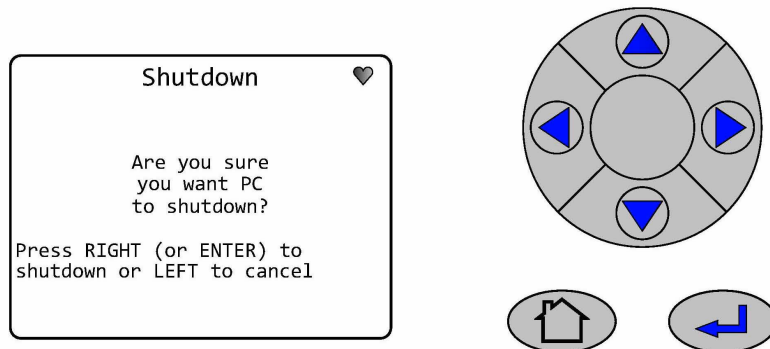

15. The screen **WILL NOT** go blank when the Shutdown has completed. Wait for the heartbeat to stop flashing (Typically 10 -15 seconds) before turning off the power.

Figure 8-4: Shutdown

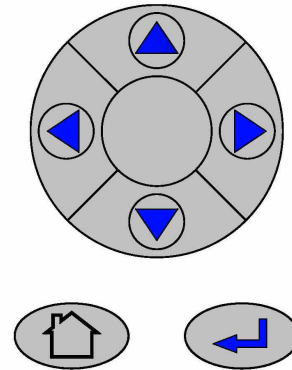
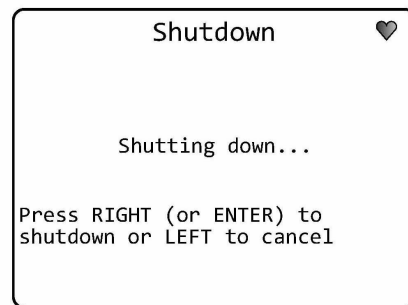

9 Preventative maintenance

As a minimum the analyzer **MUST** be visually inspected for signs of damage or corrosion at the connections weekly to confirm the continued safe operation of the analyzer.

As a minimum the Zero and Span calibration for the analyzer **MUST** be run monthly to confirm the continued accuracy of the analysis being performed. Any anomalies found should be reported to the maintenance department and where in doubt the analyzer should be switched off until rectified. Variation in customer sites may require these activities to be performed more or less often than indicated.

10 Recommended spare parts

It is not recommended for maintenance on the analyzer other than as defined in [Preventative maintenance](#) to be conducted by unauthorized personnel.

Should the need arise to have the analyzer examined you **MUST** contact customer support (cascade.support@emerson.com) or Emerson distribution partners for technical assistance.

General inquiries should be sent to (cascade.support@emerson.com).

The only authorized spare parts that are available are listed in [Table 10-1](#) below.

Table 10-1: Spare Parts List

Part Numbers	Description
P-6000-01332	6 mm Ferrule Nut (for sample gas connection)
P-6000-01272	6 mm back & front ferrules (for sample gas connection)
P-6000-00657	AC power cable UK version
P-6000-00951	AC power cable US version
P-6000-00952	AC power cable Euro version
P-6000-01441	AC power cable Chinese version
P-6000-01045	6.3 A 250 VAC ceramic cartridge fuse, 5x20 mm, speed F. IEC 60127 compliant

A Engineering drawings

These diagrams may be used to locate the position of a connector should it become disconnected.

Table A-1: Engineering Drawings

Drawing Numbers	Description
W-2000-0068	Rosemount CT4400 Half Rack System
W-2000-0069	Rosemount CT4400 Full Rack System

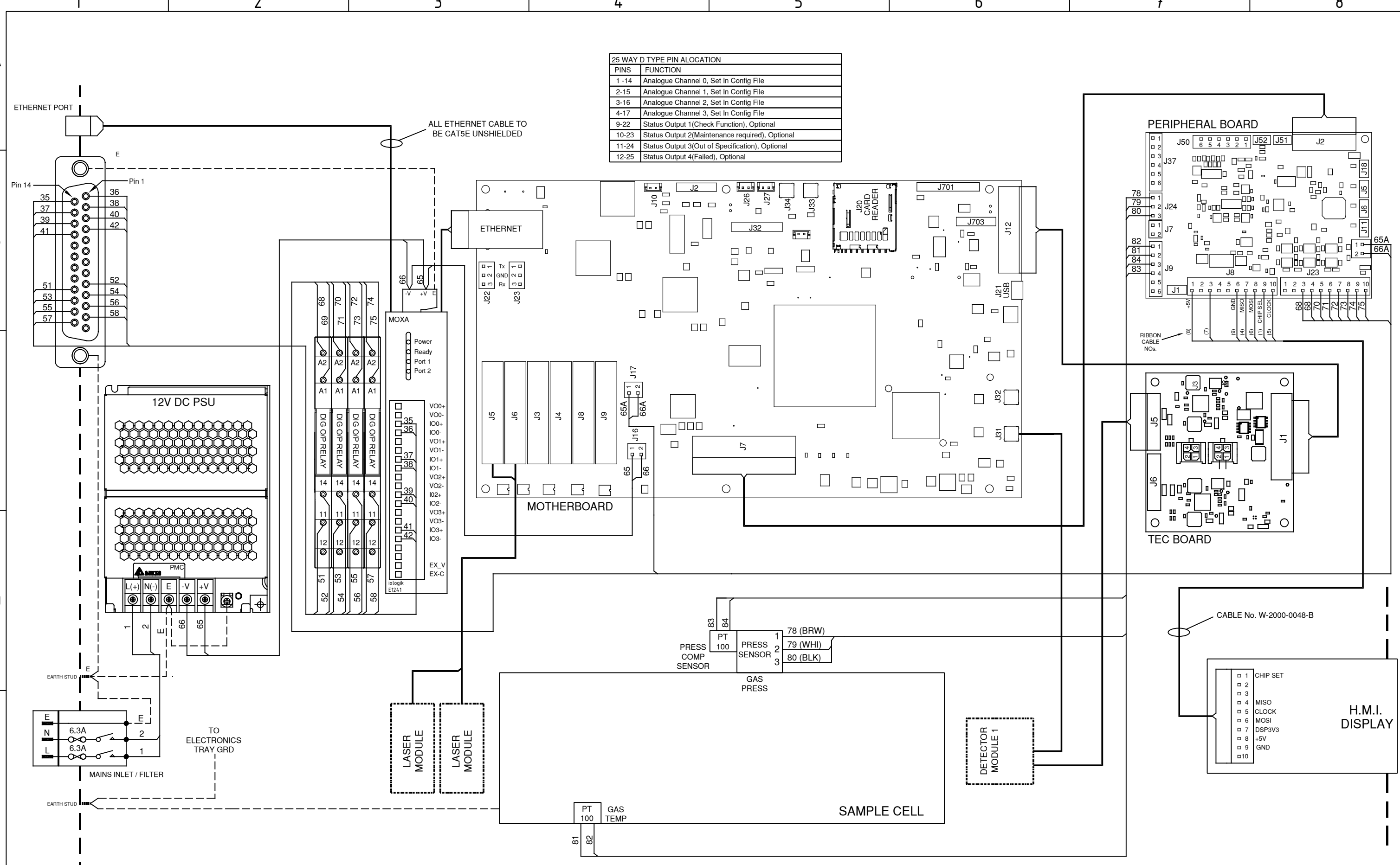

ROSEMOUNT™
 CASCADE TECHNOLOGIES LTD
 GLENDEVON HOUSE-CASTLE BUSINESS PARK
 STIRLING FK9 4TZ-UK

GENERAL DRAWING PRACTICE TO ISO14617, PNEUMATIC SYMBOLS DRAWN TO ISO1219-1, PIPING AND INSTRUMENTATION DIAGRAMS (P&ID) DRAWN TO ISO 10628, WIRING DRAWN TO IEC61346 & ICS 19-2002, WHERE APPLICABLE, CUSTOM SYMBOLS LISTED ON KEY PROVIDED, BLOCK DIAGRAMS CAN BE INSERTED TO CLARIFY FUNCTIONALITY.

THIS DRAWING AND DATA CONTAINED WITHIN IT ARE THE SOLE PROPERTY OF CASCADE TECHNOLOGIES LTD, PART OF EMERSON PROCESS MANAGEMENT AND CANNOT BE COPIED, COMMUNICATED OR REPLICATED PARTIALLY OR IN ITS ENTIRETY WITHOUT EXPRESSED WRITTEN CONSENT BY CASCADE TECHNOLOGIES LTD.

A3
 DO NOT SCALE
 DO NOT ALTER
 MANUALLY

DRAWING No:
W-2000-0068

DESCRIPTION:
CT4400 HALF RACK SYSTEM

REV.
A

DRAWN BY
JMC

CHECKED BY
DL

ISSUE DATE
 09/JAN/2018

SHEET 1 OF 1

BALLOON I.D. NO.
 1
 1,2A
 DRAWING SHEET LOC.
 DRAWING SHEET NO.

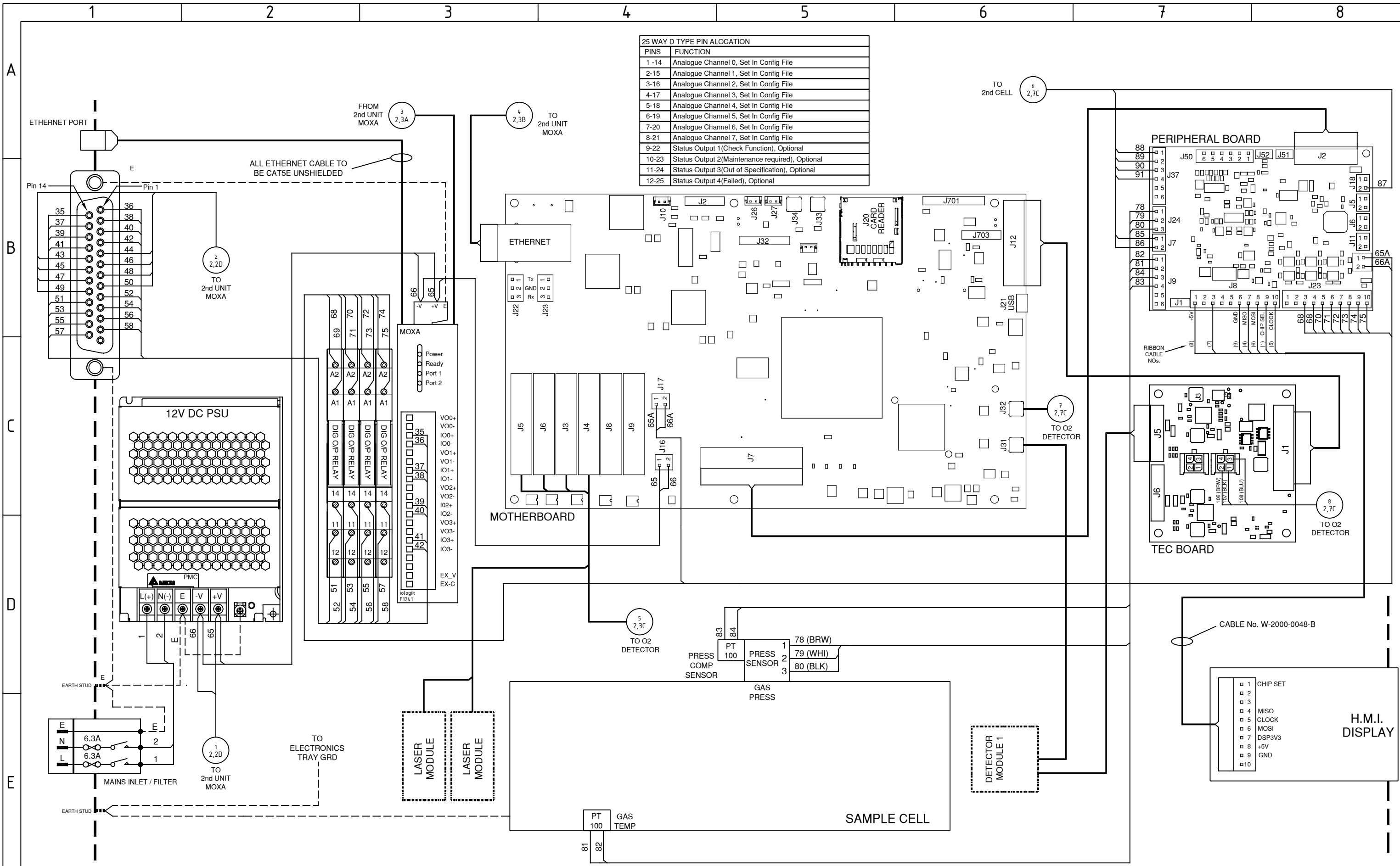

ROSEMOUNT™
 CASCADE TECHNOLOGIES LTD
 GLENDEVON HOUSE-CASTLE BUSINESS PARK
 STIRLING FK9 4TZ-UK

GENERAL DRAWING PRACTICE TO ISO14617, PNEUMATIC SYMBOLS DRAWN TO ISO1219-1, PIPING AND INSTRUMENTATION DIAGRAMS (P&ID) DRAWN TO ISO 10628, WIRING DRAWN TO IEC61346 & ICS 19-2002, WHERE APPLICABLE, CUSTOM SYMBOLS LISTED ON KEY PROVIDED, BLOCK DIAGRAMS CAN BE INSERTED TO CLARIFY FUNCTIONALITY.

THIS DRAWING AND DATA CONTAINED WITHIN IT ARE THE SOLE PROPERTY OF CASCADE TECHNOLOGIES LTD, PART OF EMERSON PROCESS MANAGEMENT AND CANNOT BE COPIED, COMMUNICATED OR REPLICATED PARTIALLY OR IN ITS ENTIRETY WITHOUT EXPRESSED WRITTEN CONSENT BY CASCADE TECHNOLOGIES LTD.

A3
 DO NOT SCALE
 DO NOT ALTER
 MANUALLY

DRAWING No:
W-2000-0069

DESCRIPTION:
CT4400 FULL RACK SYSTEM

REV.
A

DRAWN BY
JMC

CHECKED BY
DL

ISSUE DATE
 09/JAN/2018

SHEET 1 OF 2

1
 1.2A

BALLOON I.D. NO.
 DRAWING SHEET LOC.
 DRAWING SHEET NO.

DRG No:W-2000-0069 REVISION:A
 SAVED BY:JChalmers
 DATE LAST SAVED:17-Jan-19 14:47
 TEMPLATE: 7.3.3.00001-06

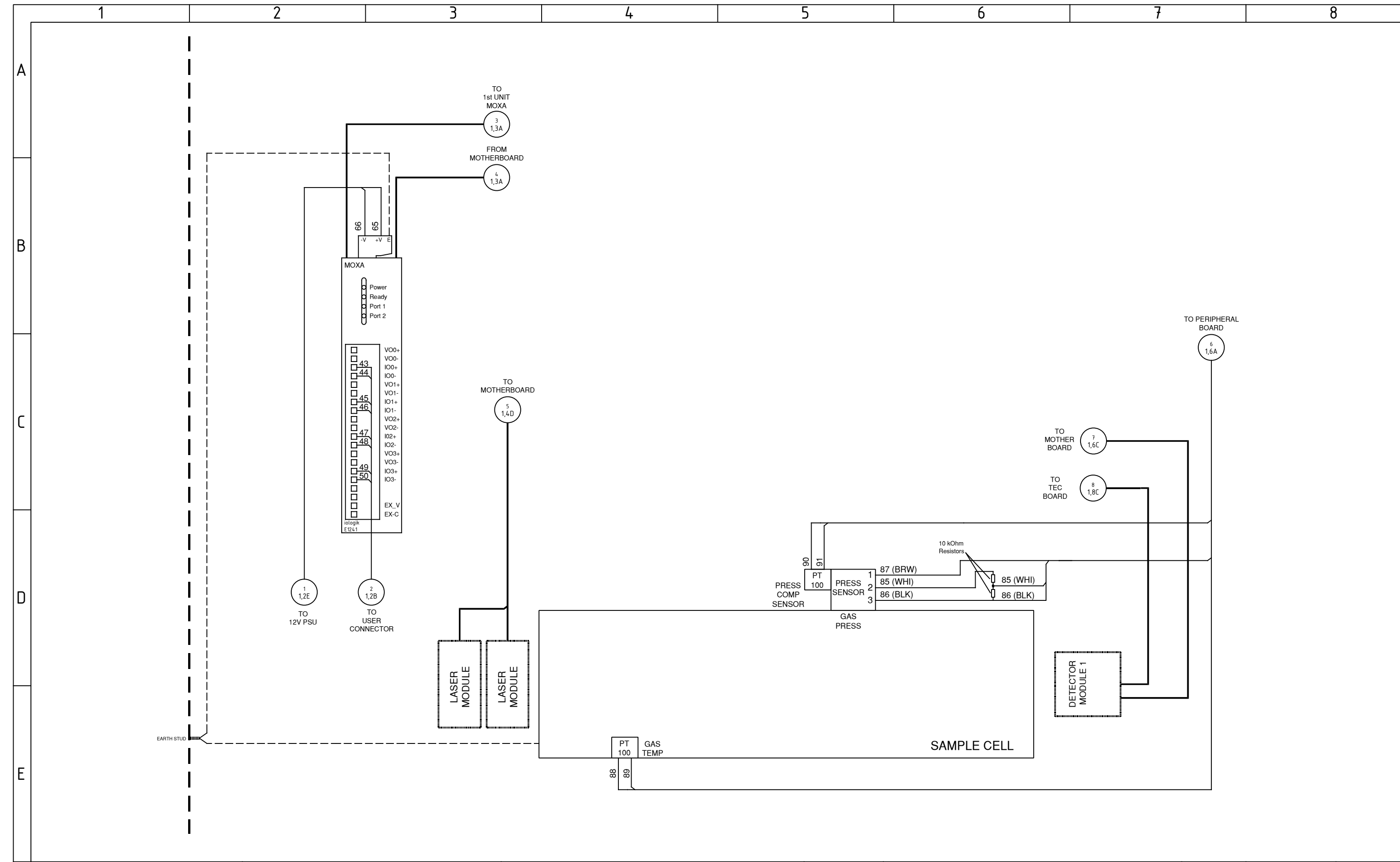

ROSEMOUNT™
 CASCADE TECHNOLOGIES LTD
 GLENDEVON HOUSE-CASTLE BUSINESS PARK
 STIRLING FK9 4TZ-UK

GENERAL DRAWING PRACTICE TO ISO14617, PNEUMATIC SYMBOLS DRAWN TO ISO1219-1, PIPING AND INSTRUMENTATION DIAGRAMS (P&ID) DRAWN TO ISO 10628, WIRING DRAWN TO IEC61346 & ICS 19-2002, WHERE APPLICABLE, CUSTOM SYMBOLS LISTED ON KEY PROVIDED, BLOCK DIAGRAMS CAN BE INSERTED TO CLARIFY FUNCTIONALITY.

THIS DRAWING AND DATA CONTAINED WITHIN IT ARE THE SOLE PROPERTY OF CASCADE TECHNOLOGIES LTD, PART OF EMERSON PROCESS MANAGEMENT AND CANNOT BE COPIED, COMMUNICATED OR REPLICATED PARTIALLY OR IN ITS ENTIRETY WITHOUT EXPRESSED WRITTEN CONSENT BY CASCADE TECHNOLOGIES LTD.

A3
 DO NOT SCALE
 DO NOT ALTER
 MANUALLY

DRAWING No:
W-2000-0069

DESCRIPTION:
CT4400 FULL RACK SYSTEM

REV.
A

DRAWN BY **JMC**
 CHECKED BY **DL**
 ISSUE DATE **09/01/2018**

SHEET 2 OF 2

1,2A BALLOON I.D. NO.
 DRAWING SHEET LOC.
 DRAWING SHEET NO.

CASCADE TECHNOLOGIES

Glendevon House
Castle Business Park
Stirling FK9 4TZ
Scotland

+44 1786 447 721
+44 1786 475 822
cascade.support@emerson.com

AMERICAS

Emerson Automation Solutions
10241 West Little York, Suite 200
Houston, TX 77040 USA

Toll Free 866 422 3683
+1 713 396 8880 (North America)
+1 713 396 8759 (Latin America)
+1 713 466 8175
cascade.support@emerson.com

EUROPE REGIONAL OFFICE

Emerson Automation Solutions
Neuhofstrasse 19a PO Box 1046
CH-6340 Baar
Switzerland

+41 (0) 41 768 6111
+41 (0) 41 768 6300
cascade.support@emerson.com

MIDDLE EAST AND AFRICA REGIONAL OFFICE

Emerson Automation Solutions
Emerson FZE
Jebel Ali Free Zone
Dubai, United Arab Emirates, P.O. Box 17033

+971 4 811 8100
+971 4 886 5465
cascade.support@emerson.com

ASIA-PACIFIC REGIONAL OFFICE

Emerson Automation Solutions
1 Pandan Crescent
Singapore 128461
Republic of Singapore

+65 6 777 8211
+65 6 777 0947
cascade.support@emerson.com

 [Linkedin.com/company/Emerson-Automation-Solutions](https://www.linkedin.com/company/Emerson-Automation-Solutions)

 twitter.com/rosemount_news

 [Facebook.com/Rosemount](https://www.facebook.com/Rosemount)

 [youtube.com/RosemountMeasurement](https://www.youtube.com/RosemountMeasurement)

©2020 Emerson. All rights reserved.

The Emerson logo is a trademark and service mark of Emerson Electric Co. Rosemount is a mark of one of the Emerson family of companies. All other marks are the property of their respective owners.