

Assembly and operating instructions

Universal gripper UG 20 | UG 25

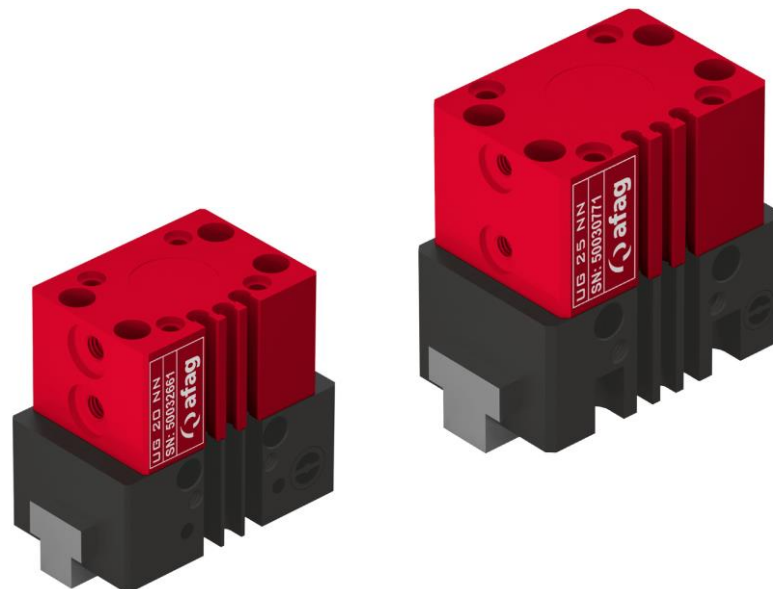

Translation of the Original Assembly Instructions EN

- UG 20 NN ⇨ Order no.: 50032661
- UG 20 NC ⇨ Order no.: 50032663
- UG 20 NO ⇨ Order no.: 50032664
- UG 25 NN ⇨ Order no.: 50030771
- UG 25 NC ⇨ Order no.: 50030772
- UG 25 NO ⇨ Order no.: 50030773

Dear Customer

Thank you for choosing our products and placing your trust and confidence in our company!

These assembly and operating instructions contain all essential information you need about your product. Our aim is to provide the required information as concisely and clearly as possible. If, however, you still have any questions on the contents or suggestions, please do not hesitate to contact us. We are always grateful for any feedback.

Our team will also be glad to answer any further question you may have regarding the universal gripper or other options.

We wish you every success with our products!

With kind regards

Your Afag team

© Subject to modifications

The universal grippers have been designed by Afag according to the state of the art. Due to the constant technical development and improvement of our products, we reserve the right to make technical changes at any time.

Updates of our documentations



Unlike the printed documents, our digital instructions manuals, product data sheets and catalogues are being continuously updated on our website.

Please keep in mind that the digital documents on our website are always the latest versions.

© Copyright 2021 Afag Automation AG

All contents of the present assembly and operating instructions, in particular the texts, photographs and graphics, are protected by copyright. All rights reserved. No part of these assembly and operating instructions may be reproduced, distributed (made available to third parties), or transmitted in any form or by any means, including photocopying, recording, or other electronic or mechanical methods, without the prior written permission of Afag Automation AG.

Afag Automation AG
Luzernstrasse 32
CH-6144 Zell (Switzerland)
Tel.: +41 62 959 86 86
e-mail: sales@afag.com
Internet: www.afag.com

Table of contents

1	General	5
1.1	Contents and purpose of these assembly instructions.....	5
1.2	Explanation of symbols.....	5
1.1	Additional symbols.....	6
1.2	Applicable documents	7
1.3	Warranty	7
1.4	Liability.....	7
2	Safety instructions	8
2.1	General	8
2.2	Intended use.....	8
2.3	Foreseeable misuse	8
2.4	Obligations of the operator and the personnel	9
2.4.1	Observe the assembly instructions	9
2.4.2	Obligations of the operating company.....	9
2.4.3	Obligations of the personnel	10
2.5	Personnel requirements	10
2.5.1	Personnel qualification	10
2.6	Personal protective equipment (PPE)	11
2.7	Changes and modifications	11
2.8	General hazards / residual risks.....	12
2.8.1	General hazards at the workplace	12
2.8.2	Danger due to electricity	13
2.8.3	Danger due to pneumatics.....	13
2.8.4	Mechanical hazards	13
3	Technical data	14
3.1	Universal gripper UG 20.....	14
3.1.1	Dimensional drawing UG 20	14
3.1.2	Technical data UG 20	15
3.1.3	Preferred combinations UG 20.....	16
3.1.4	Module loads UG 20	17
3.2	Universal gripper UG 25.....	19
3.2.1	Dimensional drawing universal gripper UG 25.....	19
3.2.2	Technical data UG 25	20
3.2.3	Preferred combinations UG 25.....	21
3.2.4	Module loads UG 25	22
4	Transport, packaging and storage	24
4.1	Safety instructions for transport.....	24
4.2	Scope of supply	24
4.3	Transport	25
4.4	Packaging.....	25
4.5	Storage	25

5	Design and description	26
5.1	Structure universal gripper	26
5.2	Product description.....	26
5.3	Accessories	27
5.4	Application example: Sensor technology in combin. with gripper fingers ..	27
6	Installation, assembly and setting	28
6.1	Safety instructions for installation and assembly	28
6.2	Assembly and attachment	29
6.2.1	Fastening the module.....	29
6.2.2	Tightening torques.....	29
6.2.1	Module centering.....	30
6.3	Pneumatic connection	31
6.4	Installation and adjustment of the inductive sensors.....	32
6.4.1	Installation of the inductive sensors	32
6.4.2	Setting inductive sensors	32
7	Commissioning	33
7.1	Safety instructions for commissioning	33
7.2	Commissioning of the modules	34
7.3	Setting up and retrofitting	34
8	Fault elimination.....	35
8.1	Safety instructions for troubleshooting	35
8.2	Fault causes and remedy	35
9	Maintenance and care	36
9.1	General notes	36
9.2	Safety instructions for maintenance and repair	36
9.3	Maintenance activities and maintenance intervals.....	37
9.3.1	Overview of the maintenance points	37
9.3.2	Further maintenance	37
9.3.3	Compressed air specification	38
9.4	Spare parts and repair work	39
10	Decommissioning, disassembly, disposal.....	40
10.1	Safety instructions for decommissioning and disposal.....	40
10.2	Decommissioning	40
10.3	Disposal.....	40
11	Declaration of incorporation	41

1 General

1.1 Contents and purpose of these assembly instructions

These assembly instructions contain important information on assembly, commissioning, functioning and maintenance of the universal grippers UG20 and UG25 to ensure safe and efficient handling and operation.

Consistent compliance with these assembly instructions will ensure:

- permanent operational reliability of the universal gripper,
- optimal functioning of the universal gripper,
- timely detection and elimination of defects (thereby reducing maintenance and repair costs),
- prolongation of the universal grippers' service life.

The illustrations in this manual shall provide you with a basic understanding of the module and may vary from the actual design of your module.

1.2 Explanation of symbols

The safety notes are marked by a pictogram and a signal word. The safety notes describe the extent of the hazard.

DANGER



Danger!

This safety note indicates an imminently hazardous situation which, if not avoided, will result in death or serious injury.

WARNING



Warning!

This safety note points out a potentially hazardous situation which, if not avoided, could result in death or serious injury.

CAUTION



Caution!

This safety note points out a potentially dangerous situation which, if not avoided, can result in minor or slight injuries.

NOTICE

This safety note points out a potentially dangerous situation which, if not avoided, can cause substantial damage to property and the environment.



This note contains important additional information as well as useful tips for safe, efficient and trouble-free operation of the universal gripper.

Further warning signs:

Where applicable, the following standardised symbols are used in this manual to point out the various potential health risks.

	Warning - Dangerous electrical voltage.
	Warning - Risk of injury from contact with hot surfaces.
	Warning - Risk of hand and finger injury due to uncontrolled movements of components.
	Warning - Magnetic field
	Warning - Risk of injury as a result of parts being flung out!
	Warning -high noise levels

1.1 Additional symbols

In these assembly instructions the following symbols are used to highlight instructions, results, references, etc.

Symbol	Description
1.	Instructions (steps ...)
⇒	Results of actions
↻	References to sections
■	Enumerations not ordered

1.2 Applicable documents



Each universal gripper is accompanied by a safety information sheet. This information sheet must be read carefully by every person who carries out work on and with the universal gripper.

1.3 Warranty

The warranty terms for Afag handling components and handling systems are the following:

- 24 months from initial operation and up to a maximum of 27 months from delivery.
- Wear parts are excluded from the warranty (The customer is entitled to a product free of defects. *This does also apply to defective accessories and wear parts. Normal wear and tear are excluded from the warranty.*)

The warranty covers the replacement or repair of defective Afag parts. Further claims are excluded.

The warranty shall expire in the following cases:

- Improper use of the module.
- Non-observance of the instructions regarding assembly, commissioning, operation and maintenance of the module.
- Improper assembly, commissioning, operation and maintenance.
- Repairs and design changes carried out without prior technical instructions of Afag Automation AG.
- Removing the serial number from the product.
- Inadequate checking of wear parts.
- Non-observance of the EC Machinery Directive, the Accident Prevention Regulations, the Standards of the German Electrotechnology Association (VDE) and these safety and assembly instructions.

1.4 Liability

No changes shall be made to the universal gripper unless described in this instructions manual or approved in writing by Afag.

Afag Automation AG accepts no liability for unauthorized changes or improper assembly, installation, commissioning, operation, maintenance or repair work.

2 Safety instructions

2.1 General

This chapter provides an overview of all important safety aspects to ensure safe and proper use of the universal gripper and optimal protection of personnel.

Safe handling and trouble-free operation of the universal gripper requires knowledge of the basic safety regulations.

Every person carrying out installation, commissioning, maintenance work or operating the universal gripper must have read and understood the complete user manual, especially the chapter on safety instructions.

Beyond this, there are rules and regulations regarding accident prevention that are applicable to the place of installation which must be observed.

Improper use may result in danger to life and limb of the user or third parties or in damage to the automation system or other material assets.



Failure to follow the directions and safety instructions given in this instructions manual may result in serious hazards.

2.2 Intended use

The universal gripper is intended for the shock-free gripping movement of loads in **non-hazardous** and in the ambient and operating conditions defined for this module (Chapter 3 Technical data).

The universal grippers UG 20/UG 25 are designed exclusively for gripping and lifting loads in any position. Gripping force of UG 20: opening 178 N, closing 150 N. Gripping force of UG 25: opening 334 N, closing 300 N. Thanks to the versatile sensor technology, the gripper can also be used for simple testing tasks during gripping.

In combination with other modules, they can be used as a pick & place station.



The intended use of the module also includes:

- observance of all instructions given in this instructions manual,
 - compliance with the inspection and maintenance work and the specifications in the data sheets,
 - using only original spare parts.
-

2.3 Foreseeable misuse

Any use other than or beyond the intended use described above is considered a misuse of the universal gripper.

Especially the following use is considered a misuse:

- Use in potentially explosive atmospheres

WARNING



Risk of injury if the module is not used as intended!

The improper use of the universal gripper poses a potential hazard to the personnel.

- The universal gripper may only be used in a technically perfect condition in accordance with its intended use and the instructions in this manual as well as in compliance with the safety requirements!
- Any malfunctions, particularly those that could impair safety, must be eliminated immediately!



Risks can occur if the module is not used as intended. In the event of damages caused by improper use the following shall apply:

- the operating company shall be solely responsible for such damage, and
- Afag does not accept any liability for damage caused by improper use.

2.4 Obligations of the operator and the personnel

2.4.1 Observe the assembly instructions

A basic prerequisite for safe and proper handling of the universal gripper is a good knowledge of the basic safety instructions.



These assembly instructions, in particular the safety instructions contained therein, must be observed by all persons working with the universal gripper.

2.4.2 Obligations of the operating company

In addition to the safety instructions given in this manual, the operating company must comply with the safety, accident prevention and environmental protection regulations valid for the field of application of the universal gripper.

The operating company is required to use only personnel who:

- have the necessary professional qualifications and experience,
- are familiar with the basic rules regarding occupational safety and accident prevention,
- have been instructed in the correct handling of the universal gripper,
- have read and understood these assembly instructions.

The operating company is also required to:

- monitor on an ongoing basis that the personnel work safely considering any potential hazard involved and the assembly instructions are observed,
- ensure that the assembly instructions are always kept at hand at the installation in which the modules are mounted,
- observe and communicate universally applicable laws and regulations regarding accident prevention and environmental protection,
- provide the necessary personal protective equipment (e.g., protective gloves) and instruct the personnel to wear it.

2.4.3 Obligations of the personnel

All personnel working with the grippers are required to:

- read and observe these assembly instructions, especially the chapter on safety,
- observe the occupational safety and accident prevention regulations,
- observe all safety and warning signs on the universal gripper,
- refrain from any activity that might compromise safety and health.



In addition, the personnel must wear the personal protective equipment required for carrying out their work. (➡ Chapter 2.6).

2.5 Personnel requirements

2.5.1 Personnel qualification

The activities described in the assembly instructions require specific requisites at the level of professional qualifications of the personnel.

Personnel not having the required qualification will not be able to assess the risks that may arise from the use of the universal gripper thus exposing himself and others to the risk of serious injury. Therefore, only qualified personnel may be permitted to carry out the described activities on the universal gripper.

Persons whose ability to react is restricted due to the intake of medication or the like must not interact with the universal gripper.

These installation instructions are intended for skilled personnel (installers, system integrators, maintenance personnel, technicians), electricians and operating personnel.

The following is a description of the professional skills (qualifications) required for carrying out the different activities:

Qualified personnel:

Qualified personnel with appropriate training who are qualified due to their special know-how and fully familiar with the machine and who have been given instructions on how to carry out the task entrusted to them safely.

Operator (trained personnel):

Authorized persons who due to their specialized professional training, expertise and experience are capable of identifying risks and preventing possible hazards arising from the use of the machine.





2.6 Personal protective equipment (PPE)

The personal protective equipment serves to protect the personnel from hazards affecting their safety and health at work.

When working on/with the universal gripper, the personnel must wear the personal protective equipment assigned by the safety officer of the operating company or as required by safety regulations. In addition, the personnel is required to:

- wear the personal protective equipment provided by the operating company (employer),
- check the personal protective equipment for proper condition, and
- immediately notify the person responsible on site of any defects found on the personal protective equipment.

Personal protective equipment and the respective mandatory signs:

	<p><i>Protective clothing</i> is a close-fitting clothing specifically designed to protect personnel from hazards during work.</p>
	<p><i>Protective gloves</i> are specifically designed to protect the personnel against hand injuries (such as cuts, abrasion, burns).</p>
	<p><i>Safety shoes</i> are specifically designed to protect the personnel against foot injuries from crushing, falling objects or slipping on slippery surfaces.</p>
	<p>Hearing protectors are required to protect the personnel against excessive noise levels to prevent noise-induced hearing loss.</p>

2.7 Changes and modifications

No changes may be made to the universal gripper which have not been described in these assembly instructions or approved in writing by Afag.

Afag Automation AG accepts no liability for unauthorised changes or improper assembly, installation, commissioning, maintenance or repair work.



The universal gripper may not be changed or modified in any way, except with the prior written consent of Afag.

2.8 General hazards / residual risks

Despite the safe design of the universal gripper and the technical protective measures taken, there still remain residual risks that cannot be avoided, and which present a non-obvious residual risk when operating the module.

Observe the safety instructions in this chapter and in the other sections of this manual to avoid damage to property and dangerous situations for the personnel.

2.8.1 General hazards at the workplace

The universal gripper has been built according to the state-of-the-art and the applicable health and safety requirements. However, improper use of the universal gripper may cause the following hazards to the personnel:

- danger to life and limb of the operator or third parties,
- on the universal grippers themselves,
- property damage.



Always keep the assembly instructions ready at hand at the workplace! Please, also observe:

- the general and local regulations on accident prevention and environmental protection,
- the safety information sheet for the universal gripper.

WARNING



Danger - Do not use in unsuitable environment!

The universal grippers are designed for use in **non** explosive atmospheres.

- Do **not** use the modules in potentially explosive atmospheres!

CAUTION



Risk of injuries due to uncontrolled parts movements!

When operating the universal gripper uncontrolled movements may occur which can cause personal injury or property damage.

- Only qualified personnel may work with or on the universal gripper.
- Read the assembly instructions carefully before carrying out any work on or with the universal gripper.

2.8.2 Danger due to electricity

WARNING



Danger! Risk of electric shock!

If work on electrical components is required, ensure that the work is carried out properly, failure to do so will cause serious or fatal injuries.

- Work on the machine's electrical equipment may only be performed by skilled electrician or trained personnel under the supervision of a skilled electrician in accordance with all relevant electrical regulations.
-

2.8.3 Danger due to pneumatics

WARNING



Risks by the pneumatic system!

The pneumatic system can pose various hazards that can cause serious or fatal injuries if the work is carried out improperly.

- Only qualified personnel may work with or on the pneumatic system!
 - The necessary personal protective equipment must be provided and used.
-

2.8.4 Mechanical hazards

CAUTION



Danger of injury by moving components!

Limbs can be crushed by moving components!

- Work on and with the universal gripper may only be carried out by qualified personnel.
 - Never reach into the system during normal operation!
-

3 Technical data

3.1 Universal gripper UG 20

3.1.1 Dimensional drawing UG 20

Type	UG 20 NN	UG 20 NC	UG 20 NO
A	Sensor Ø 4 mm	Sensor Ø 4 mm	Sensor Ø 4 mm
B	Proximity switch	Proximity switch	Proximity switch

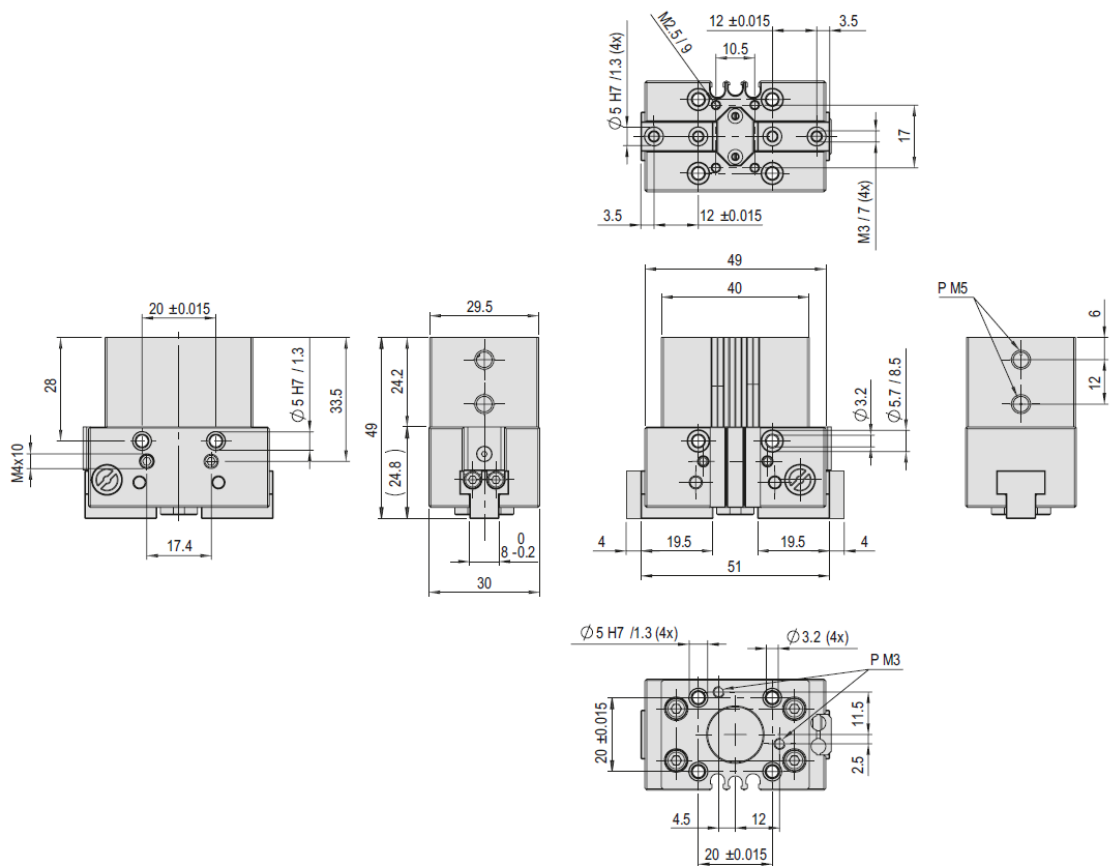

Fig. 1 Dimensional drawing - Universal gripper UG 20

Technical data

3.1.2 Technical data UG 20

UG 20	
Attachment grid	20 x 20 mm
Attachment thread	Mounting holes 3.2 mm
Operating pressure	6 +/- 2 bar
Air connection P	M5
Cylinder Ø	20 mm
Operating temperature	0 - 50 °C

Type	UG 20 NN	UG 20 NC	UG 20 NO
Order number	50032661	50032663	50032664
Net weight	0.17 kg	0.172 kg	0.172 kg
Air consumption/cycle	0.0239 NL	0.0239 NL	0.0239 NL
Gripping time	0.03 s	0.03 s	0.03 s
Closing time	**Closing time = Finger weight 0.20 s = 150 g 0.05 s = 100 g 0.03 s = 80 g		
Gripping force, opening	178 N	139 N	226 N
Gripping force, closing	150 N	188 N	105 N
Max. admissible weight per gripper finger	150 g	150 g	150 g
Spring force		38 N	48 N
Opening stroke	2 x 4 mm	2 x 4 mm	2 x 4 mm
Repeat accuracy	+/- 0.02 mm	+/- 0.02 mm	+/- 0.02 mm
Mounting position	✦	✦	✦

The technical data refer to a nominal pressure of 6 bar under Afag standard test conditions.
 The module can be operated with lubricated or dry air.
 Cleanroom class ISO 14644-1, class ISO 7

- *Observe gripping force diagrams
- Measurements for slowly closing fingers
- All module measurements carried out via outer clamping
- **Closing times in unthrottled operation Observe gripping force diagrams
- Measurements for slowly closing fingers
- All module measurements carried out via outer clamping

Included in the delivery (Catalogue HT accessories)

- 2x Centering bushing Ø5x2.5
- 2x Mounting screw M3x30
- 4x Mounting screw M3x50

Accessories (Catalogue HT accessories)

- INI c10x19.5-Em-PNP-NO-M8x1
- INI c10x28.5-Em-PNP-NO-M8x1

Alternative accessories (Catalogue HT accessories)

- INI d4x25-Sn1.0-PNP-NC-M8x1
- INI d4x25-Sn1.0-PNP-NO-M8x1
- INI M4x12-Sn0.8-PNP-NO

3.1.3 Preferred combinations UG 20

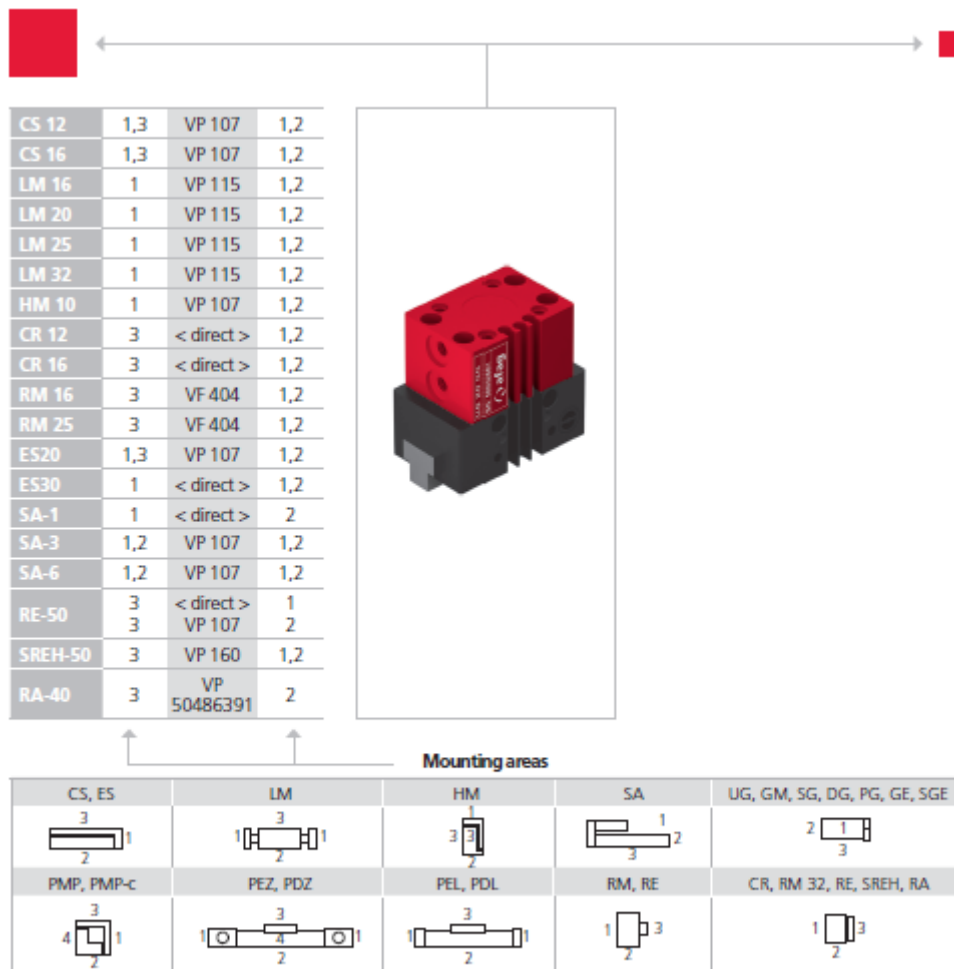

Note that there might be different mounting positions from one module to another one.

The required connection elements and the range of support columns are depicted in the catalogue HT accessories.

3.1.4 Module loads UG 20

Type	UG 20 NN
Max. static torque Mx	7 Nm
Max. static torque My	7 Nm
Max. static torque Mz	7 Nm
Max. dynamic torque Mx	0.07 Nm
Max. dynamic torque My	0.07 Nm
Max. dynamic torque Mz	0.07 Nm
Max. static force F	150 N
Max. dynamic force F	1.5 N

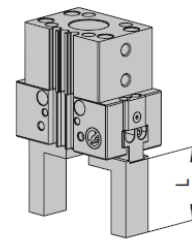
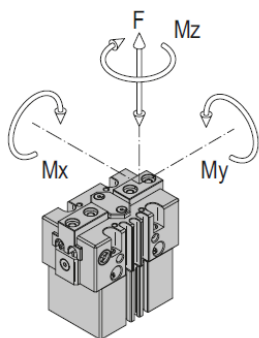

Finger length centric

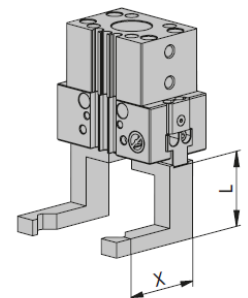

Finger length eccentric

Gripping force diagrams per jaw

Eccentric - UG 20 NN opening

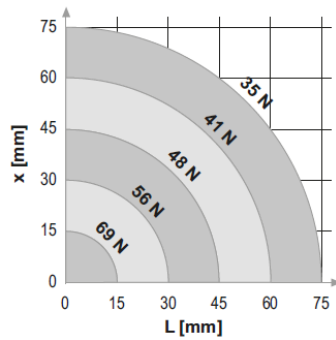

Eccentric - UG 20 NN closing

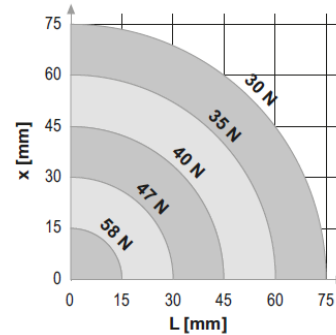

Centric - UG 20 NN opening

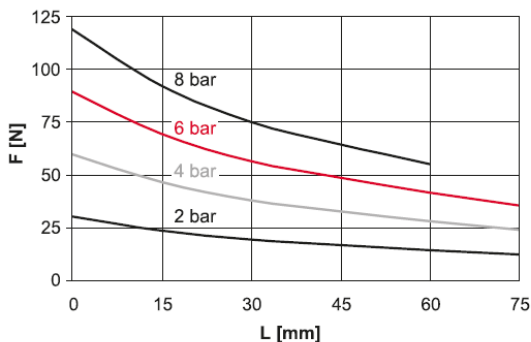

Centric - UG 20 NN closing

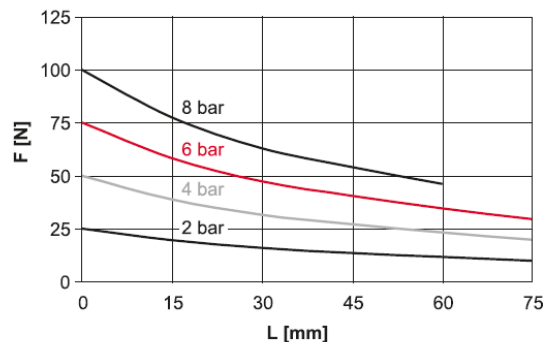

Eccentric - UG 20 NC closing

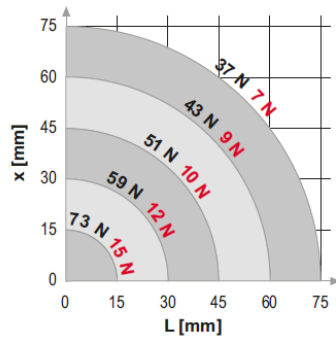

Centric - UG 20 NC closing

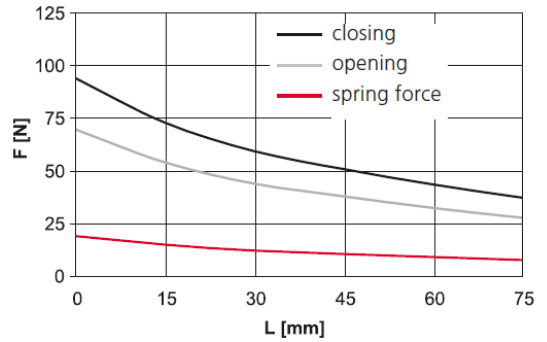

Eccentric - UG 20 NN opening

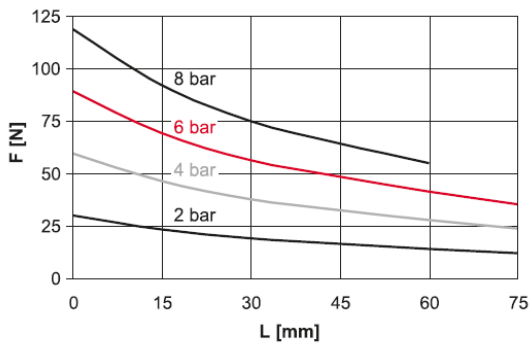

Centric - UG 20 NO opening

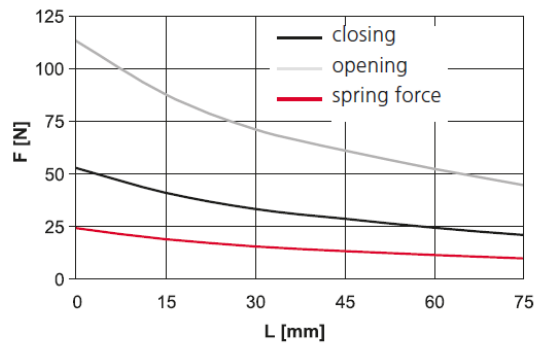

3.2 Universal gripper UG 25

3.2.1 Dimensional drawing universal gripper UG 25

Type	UG 25 NN	UG 25 NC	UG 25 NO
A	Sensor Ø 4 mm	Sensor Ø 4 mm	Sensor Ø 4 mm
B	Proximity switch	Proximity switch	Proximity switch

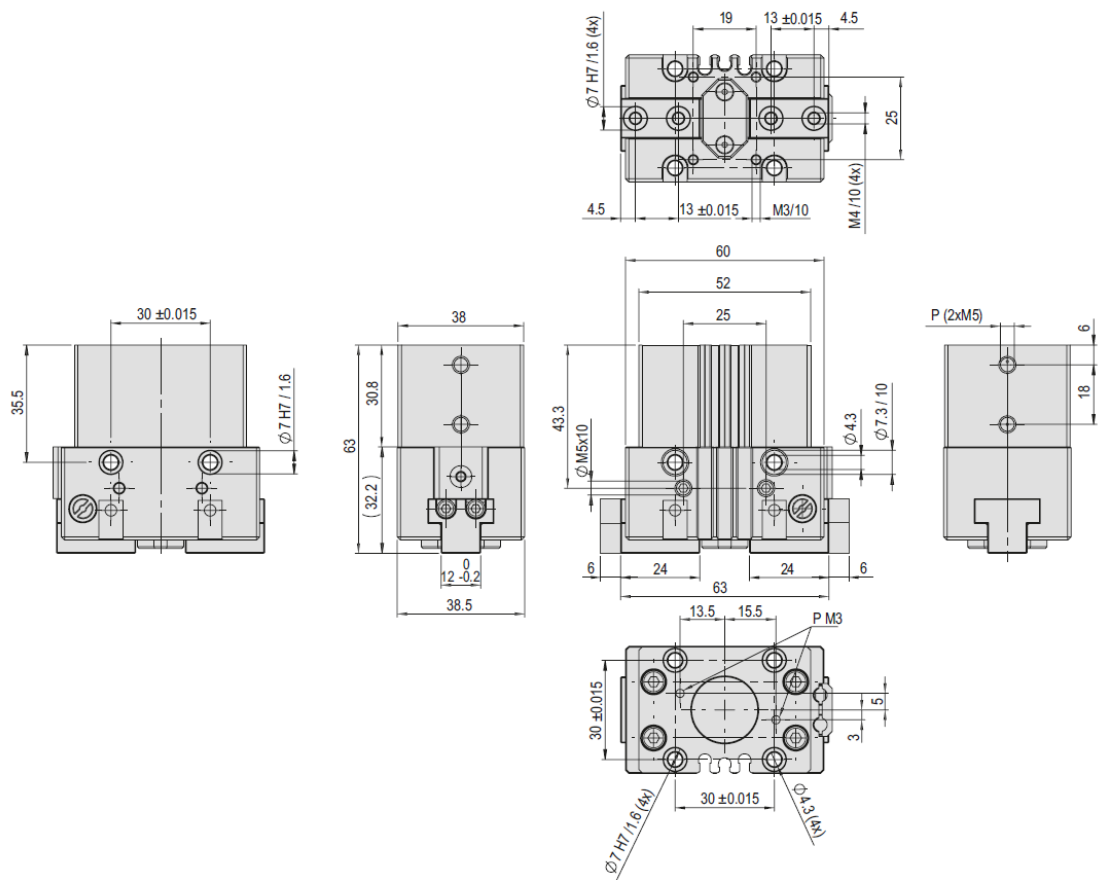

Fig. 2 Dimensional drawing - Universal gripper UG 25

3.2.2 Technical data UG 25

UG 25	
Attachment grid	30 x 30 mm
Attachment thread	Mounting holes 4.3 mm
Operating pressure	6 +/- 2 bar
Air connection P	M5
Cylinder Ø	25 mm
Operating temperature	0 - 50 °C

Type	UG 25 NN	UG 25 NC	UG 25 NO
Order number	50030771	50030772	50030773
Net weight	0.384 kg	0.389 kg	0.388 kg
Air consumption/cycle	0.0552 NL	0.0552 NL	0.0552 NL
Gripping time	0.05 s	0.05 s	0.05 s
Closing time	**Closing time = Finger weight 0.20 s = 250 g 0.05 s = 150 g 0.03 s = -		
Gripping force, opening	*334 N	*268 N	*407 N
Gripping force, closing	*300 N	*366 N	*227 N
Max. admissible weight per gripper finger	250 g	250 g	250 g
Spring force		66 N	73 N
Opening stroke	2 x 6 mm	2 x 6 mm	2 x 6 mm
Repeat accuracy	+/- 0.02 mm	+/- 0.02 mm	+/- 0.02 mm
Mounting position	✦	✦	✦

The technical data refer to a nominal pressure of 6 bar under Afag standard test conditions.
 The module can be operated with lubricated or dry air.
 Cleanroom class ISO 14644-1, class ISO 7

- *Observe gripping force diagrams
- Measurements for slowly closing fingers
- All module measurements carried out via outer clamping
- **Closing times in unthrottled operation Observe gripping force diagrams
- Measurements for slowly closing fingers
- All module measurements carried out via outer clamping.

- Included in the delivery**
 (Catalogue HT accessories)
- 2x Centering bushing Ø7x3
 - 2x Mounting screw M4x35
 - 4x Mounting screw M4x55

- Accessories**
 (Catalogue HT accessories)
- INI c10x19.5-Em-PNP-NO-M8x1
 - INI c10x28.5-Em-PNP-NO-M8x1

3.2.3 Preferred combinations UG 25

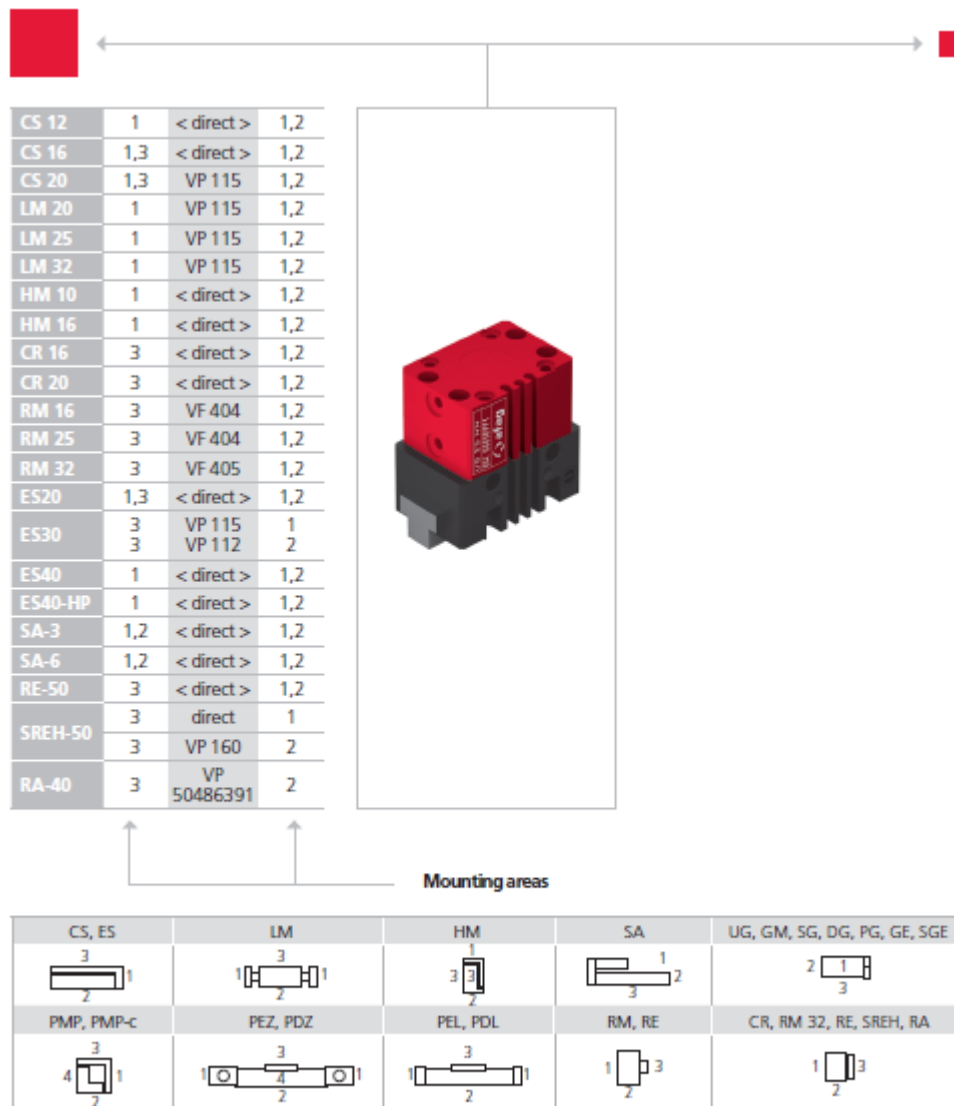

Note that there might be different mounting positions from one module to another one.

The required connection elements and the range of support columns are depicted in the catalogue HT accessories.

3.2.4 Module loads UG 25

Type	UG 25 NN
Max. static torque Mx	12 Nm
Max. static torque My	12 Nm
Max. static torque Mz	12 Nm
Max. dynamic torque Mx	0.12 Nm
Max. dynamic torque My	0.12 Nm
Max. dynamic torque Mz	0.12 Nm
Max. static force F	250 N
Max. dynamic force F	2.5 N

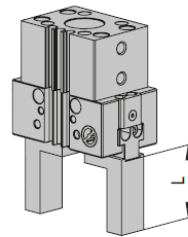
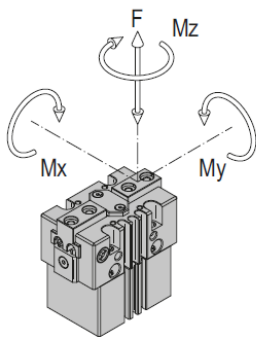

Finger length centric

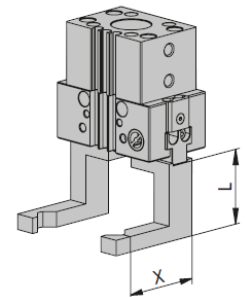

Finger length eccentric

Gripping force diagrams per jaw

Eccentric - UG 25 NN opening

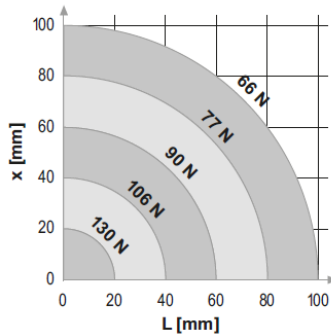

Eccentric - UG 25 NN closing

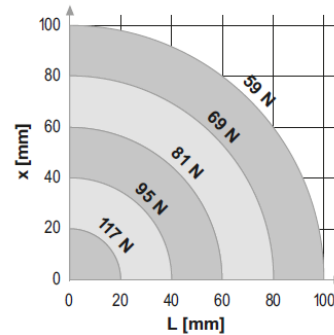

Centric - UG 25 NN opening

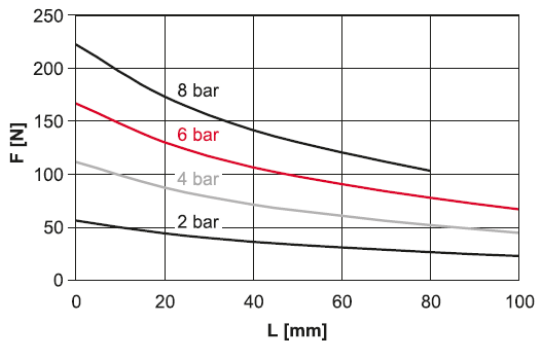

Centric - UG 25 NN closing

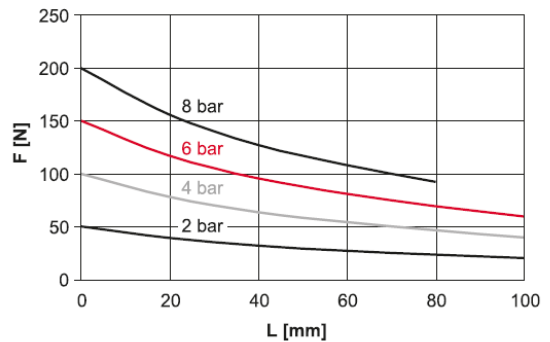

Eccentric - UG 25 NC closing

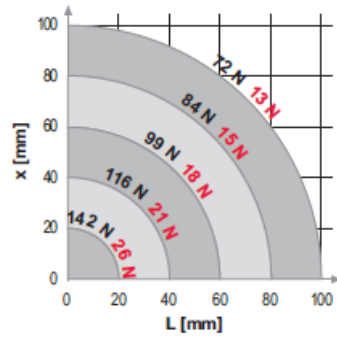

Centric - UG 25 NC closing

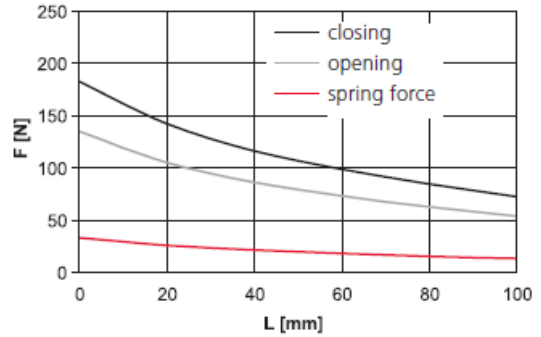

Eccentric - UG 25 NO opening

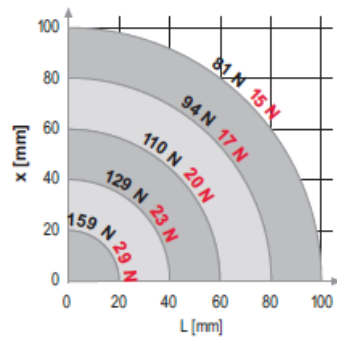

Centric - UG 25 NO opening

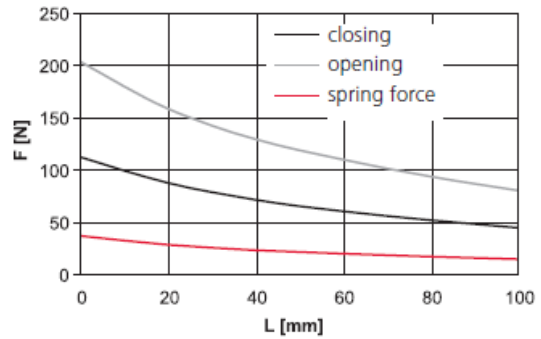

4 Transport, packaging and storage

4.1 Safety instructions for transport



CAUTION

Risk of injury when unpacking the universal gripper!

The universal grippers can fall out of the cardboard box when unpacking and injure limbs.

- Carefully unpack the universal gripper.



Also observe the safety instructions in  chapter 2 „Safety instructions“ in this manual.

4.2 Scope of supply



In addition to the assembly and operating instructions, a safety information sheet is enclosed with each universal gripper.

This information sheet must be read by every person who carries out work with and on the universal gripper!

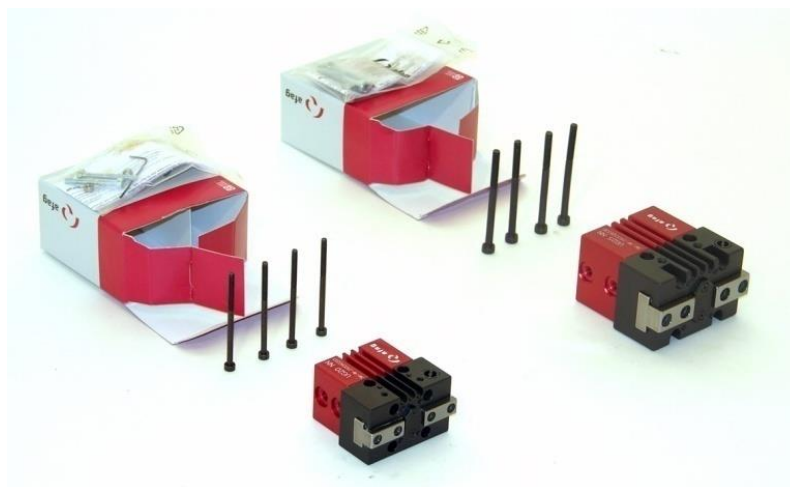

Fig. 3 Scope of delivery universal gripper UG 20 and UG 25

[Unt]	UG 20	UG 25
1 x	Module UG 20	Module UG 25
2 x	Centering bushing \varnothing 5x2.5	Centering bushing \varnothing 7x3 mm
2 x	Fastening screws M3x30 mm	Fastening screws M4x35 mm
4 x	Fastening screws M3x50 mm	Fastening screws M4x55 mm
1 x	Assembly & operat. instructions	Assembly & operating instructions

4.3 Transport



No liability can be assumed for damages caused by improper installation on the part of the operating company.



The following values must be observed for transport:

- Storage temperature: 0-50 °C
 - Relative air humidity: < 90%, non condensing
-

4.4 Packaging

The universal gripper is transported in the Afag transport packaging. If no Afag packaging is used, the universal gripper must be packed in such a way that it is protected against shocks and dust.

NOTICE

Risk to the environment due to incorrect disposal of the packaging material!

Environmental damage can be caused by incorrect disposal of the packaging material.

- Dispose of the packaging material in an environmentally sensitive way in accordance with the local environmental regulations.
-

4.5 Storage

If the universal gripper is stored for an extended period, observe the following:

- Store the universal gripper in the transport packaging.
- Do not store the telescope spindle axes outdoors or expose them to weather conditions.
- The storage space must be dry and dust free.
- Room temperature of the storage space: 0-50 °C.
- Relative air humidity: < 90% non condensing.
- Clean the universal gripper and protect the blank metal parts against corrosion using the appropriate means.
- Protect the universal gripper from dirt and dust.

5 Design and description

5.1 Structure universal gripper

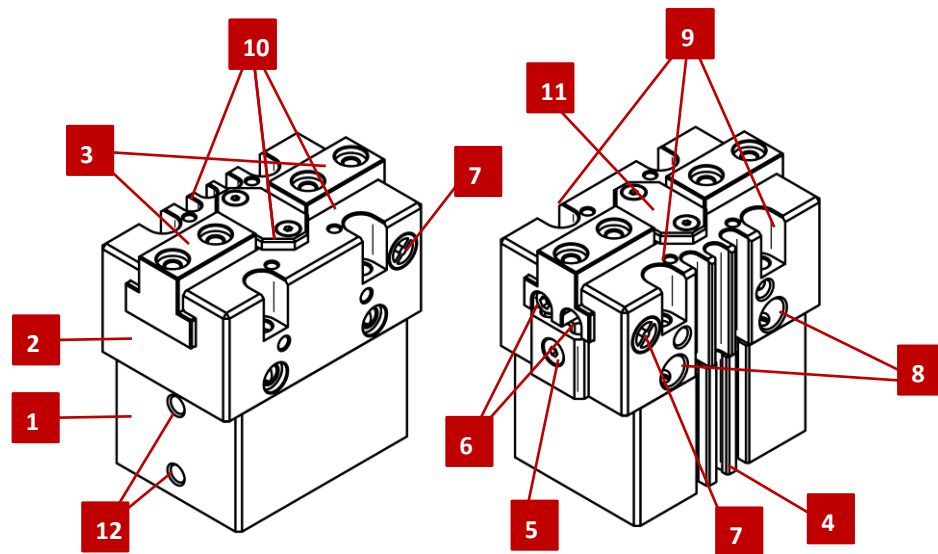

Fig. 4 Structure of the universal gripper (example)

- | | |
|-----------------------------------|-------------------------------------|
| 1. Cylinder housing | 7. Cover fastening screws |
| 2. Jaw housing | 8. Lateral mounting hole |
| 3. Gripper jaws | 9. Top mounting hole |
| 4. C-slots for magnetic sensors | 10. Fastening thread hold-down unit |
| 5. Holder for inductive sensors | 11. Cover plate gripping mechanism |
| 6. Adjustm. screws stroke recogn. | 12. Pneumatic connections |

5.2 Product description

The UG 20 and UG 25 grippers are composed of the cylinder housing (Fig.4, 1) and the jaw housing (Fig. 4, 2). The two housings are firmly connected to each other and cannot be separated. The pneumatic cylinder is integrated in the cylinder housing (Fig. 4, 1) and transmits its movement to the gripper jaws (Fig. 4, 3) via two bell cranks. The gripper jaws (Fig. 4, 3) move parallel to each other. The gripping mechanism is protected from dirt by the cover plate (Fig. 4, 11).

The grippers are available in the versions NN (without spring preload), NC (pressureless closed) and NO (pressureless open). Conversion is not possible. Depending on the requirements, up to three magnetic sensors (see accessories) can be mounted in the C-slots (Fig. 4, 4) and up to two inductive sensors (see accessories) can be mounted in the holder (Fig. 5, 5) to monitor the gripping positions. Thus, up to 5 positions can be tested with the gripper.

One possible application is detection of "gripper open", "gripper closed" and "part gripped". When using positive gripper fingers and asymmetrical parts, it is also possible to check whether the part is held in the correct position in the gripper.

The sensors are covered with the adjustment screws (Fig. 4, 6). To adjust the adjusting screws (Fig. 4, 6), the screws under the cover (Fig. 4, 7) must be loosened and then fastened. The four threads (Fig. 4, 10) can be used to mount attachments.

5.3 Accessories

UG 20	Order Number
Centering bushing Ø 7x3 mm	11016850
INI C10x28.5-Em-PNP-NO-M8x1	50033432
INI c10x9-Em-PNP-NO-M8x1	50313986
INI Ø4x25-Sn1.0-PNP-NO-M8x1	11016714
INI Ø4x25-Sn1.0-PNP-NC-M8x1	50093507
INI c10x19,5-Em-PNP-NO-M8x1	50313987

5.4 Application example: Sensor technology in combination with gripper fingers

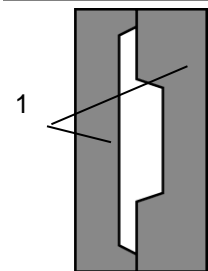
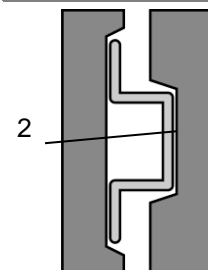
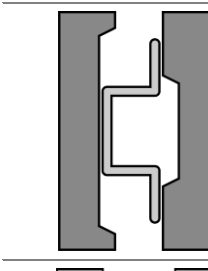
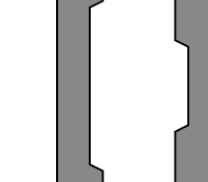
Gripper position	Description
	<ul style="list-style-type: none"> ▪ Gripper closed ▪ The gripping fingers (1) touch each other. ▪ This position is typically detected via a magnetic sensor.
	<ul style="list-style-type: none"> ▪ Part (2) correctly gripped ▪ Depending on the size and shape of the part, this position is detected via magnetic or inductive sensors. For highest accuracy, this position is detected by means of two inductive sensors. The sensors are set so that one sensor responds, and the second sensor does not. This allows correct gripping to be detected.
	<ul style="list-style-type: none"> ▪ Part not gripped correctly ▪ In this position, all sensors do not respond if the gripper fingers are suitably designed.
	<ul style="list-style-type: none"> ▪ Gripper opened ▪ This position is typically detected via a magnetic sensor.



Depending on the part and finger shape, optimum operational reliability can also be achieved via alternative sensor evaluations.

6 Installation, assembly and setting



The system operator is responsible for the installation of the universal gripper in a system!

6.1 Safety instructions for installation and assembly

The universal gripper is an incomplete machine.

For safe operation, the universal grippers must be integrated into the safety concept of the system in which they are installed.

During normal operation, it must be ensured that the user cannot interfere with the working area of the universal gripper.



When integrating a universal gripper into an assembly system, the customer must provide an appropriate enclosure or safety barrier.

CAUTION

Risk of injury due to mounted components!



The gripper fingers are set in motion by the pneumatic control. Attachments can restrict the free movement of the fingers of the gripper and cause injuries such as crushing.

- Make sure that the movement of the gripper fingers is not restricted by mounted attachments.
- Take appropriate measures to ensure safe operation!



No liability for damages can be assumed for damages caused by improper installation/assembling work on the part of the operator.



Also observe the safety instructions in  chapter 2 „Safety instructions“ in this manual.

6.2 Assembly and attachment

The universal grippers can be mounted both in horizontal and vertical position.



To ensure high and repetitive accuracy of fit during assembly, operation and exchanging of a module, the components of the Afag modules are provided with a precise module centering unit.

6.2.1 Fastening the module

Depending on the application, the gripper can be attached from the side or from below.

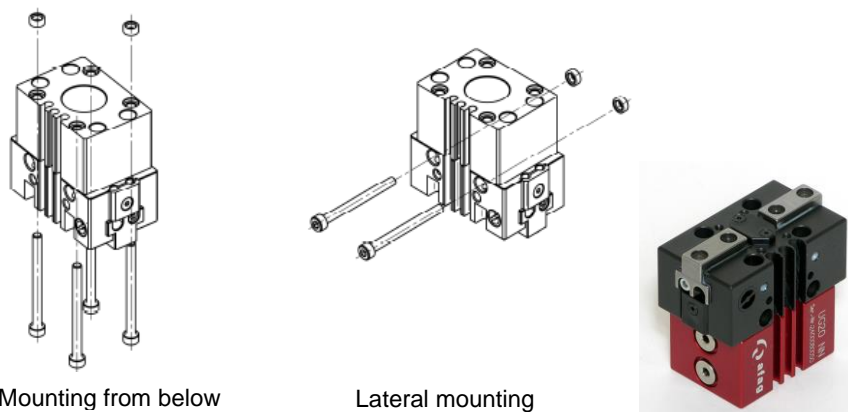

Fig. 5 Fastening of the universal gripper (example)



Use the centering bushings (➔ chapter 4.2) included in the scope of delivery for positioning.

6.2.2 Tightening torques

For mounting, screws must be used which at least correspond to the specification listed below:

Standard	VDI 2230
Screw strength	Category 8.8
Surface:	Galvanized blue, oiled or greased

Thread	Tightening torque
M3	1.1 ... 1.4 Nm
M4	2.6 ... 3.3 Nm
M5	5.2 ... 6.5 Nm
M6	9.0 ... 11.3 Nm
M8	21.6 ... 27.3 Nm

6.2.1 Module centering

For positioning use the centring sleeves included in the supply. Insert the centering sleeves into two diagonally opposite holes of the attachment grid.

Universal gripper	UG 20	UG 25
Hole grid	20 x 20 mm	30 x 30 mm
Bore and mounting thread	M3	M4
Centering bushing (H7) 11004942	Ø 5x2.5 mm	Ø 7x3 mm

Centering bushings	Ø4x2	Ø5x2.5	Ø7x3	Ø8x3.5	Ø9x4	Ø12x4.8	Ø19x5.8
Order number	50332257	50035831	11016850	50263565	11004942	50187424	50189497
Net weight	0.001 kg	0.001 kg	0.001 kg	0.001 kg	0.001 kg	0.002 kg	0.006 kg
A	4 mm	5 mm	7 mm	8 mm	9 mm	12 mm	19 mm
B	2 mm	2.5 mm	3 mm	3.5 mm	4 mm	4.8 mm	5.8 mm
C	2.6 mm	3.2 mm	4.3 mm	5.4 mm	6.5 mm	8.5 mm	13 mm

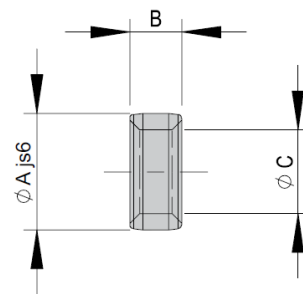

Bores							
Ø A*	19H7	12H7	9H7	8H7	7H7	5H7	4H7
Ø B	13	8.5	6.5	5.4	4.3	3.2	2.6
Ø C	M12	M8	M6	M5	M4	M3	M2.5
D	3.0 (+0.1/0)	2.5 (+0.1/0)	2.1 (+0.1/0)	1.8 (+0.1/0)	1.6 (+0.1/0)	1.3 (+0.1/0)	1.1 (+0.1/0)

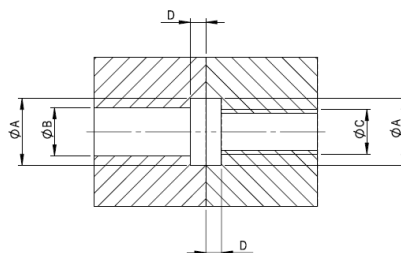

*for several old modules, the bores are still K7 tolerated.

Attachment grid	16x16 mm	20x20 mm	30x30 mm	38x38 mm	48x48 mm	60x60 mm	75x75 mm	96x96 mm
A	16 mm	20 mm	30 mm	38 mm	48 mm	60 mm	75 mm	96 mm
B	8 mm	10 mm	15 mm	19 mm	24 mm	30 mm	38 mm	48 mm
C	4x1.1 mm	5x1.3 mm	7x1.6 mm	8x1.8 mm	9x2.1 mm	12x2.5 mm	15x2.7 mm	19x3 mm
D	M2.5	M3	M4	M5	M6	M8	M10	M12

Module-centering, centering bushings

In order to guarantee a high and repetitive fit accuracy during installation, operation or replacement of a module, all components of the entire program are consequently provided with a precise module centering. Centering bushings or pins are supplied as standard with each module.

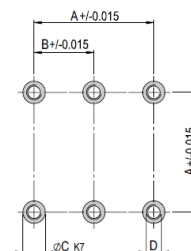

6.3 Pneumatic connection

Please refer to the technical dimensional drawings in (➡ chapter 3)!

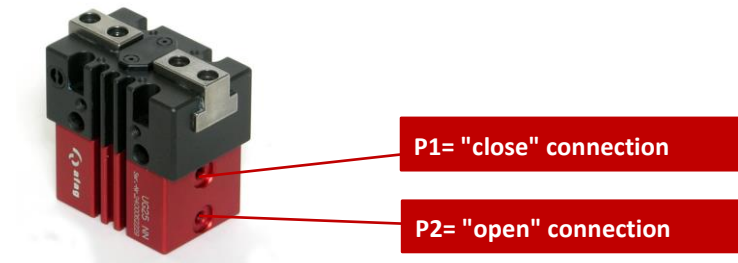

Fig. 6 Pneumatic connections universal gripper



Unused air connections must be sealed airtight before the module is installed in a system.

Important: Perform a leakage test!

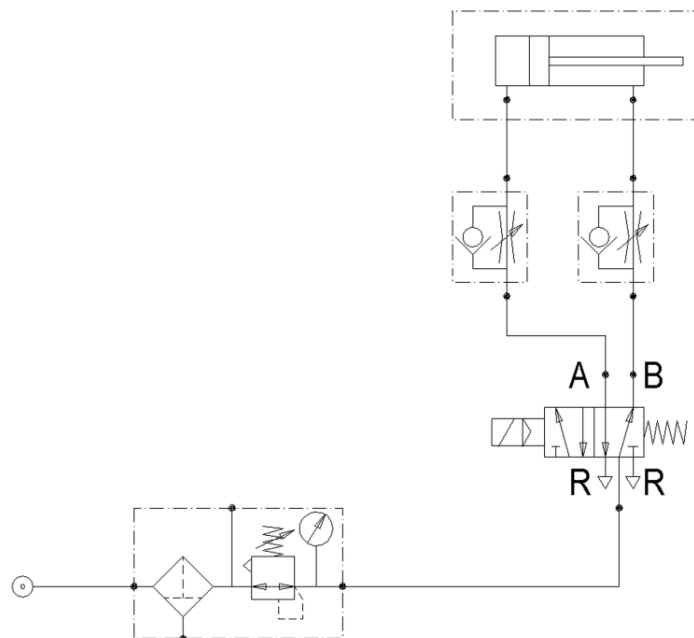

Fig. 7 Pneumatic diagram universal gripper

- | | |
|------------------------------|-----------------------------------|
| 1. Compressed air connection | 4. Throttle valve |
| 2. Maintenance unit | 5. Gripper (UG 20 - UG 25) |
| 3. 5/2 Way-valve | P1/P2: Compressed air connections |

6.4 Installation and adjustment of the inductive sensors

6.4.1 Installation of the inductive sensors

The gripper is provided with C-slots to accommodate the sensors. The two proximity switches detect the opening/closing position.

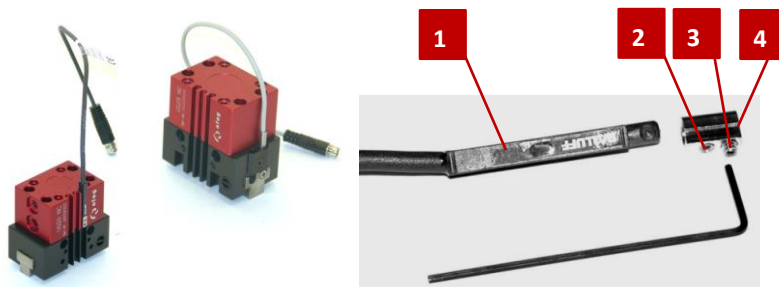

Fig. 8 Installation of the inductive sensors

- | | |
|---------------------------|--------------------------------------|
| 1. Proximity switch | 3. Fastening screw of clamping piece |
| 3. Screw proximity switch | 4. Clamping piece |

Procedure:

1. Insert the proximity switch (Fig. 8, 1) with the mounted clamping piece into the C-slot.
 2. Fasten the proximity switch in the C-slot with the fastening screws on the clamping piece (Fig. 8, 4).
 3. Connect the proximity switch to the control system.
- ⇒ The inductive sensors are mounted.

6.4.2 Setting inductive sensors

The rough adjustment of the sensors to be used is carried out in the depressurised state of the system (see below).

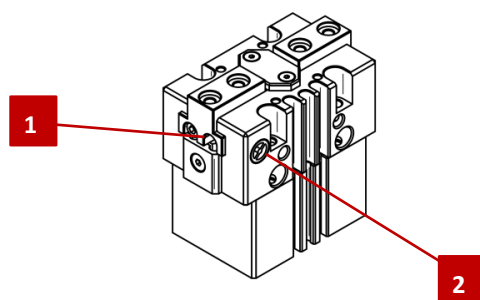

Fig. 9 Setting inductive sensors

1. Remove cover (Fig. 9, 1) with needle-nose pliers.
 2. Loosen the screw under the cover (slotted screwdriver size 00).
 3. Set the adjustment screws (Fig. 9, 2) for stroke detection.
 4. Check the function of the sensor, readjust if necessary.
 5. Tighten the fastening screw again.
 6. Insert cover.
- ⇒ The inductive sensors are adjusted.

7 Commissioning

After connection, the universal grippers are put into operation for the first time via the system controller.

7.1 Safety instructions for commissioning

CAUTION



Danger of injury in the working area of the universal gripper!

Due to the decentralised control system, the operator of the gripper must not necessarily stand next to the module during operation so that he may not have a complete view of the working area. Persons in the working area may be injured.

- When operating the universal gripper, ensure a good overview of the entire working area.
- Unauthorized persons must not stay within the working area during operation.

CAUTION



Risk of injuries due to uncontrolled parts movements!

When the control is switched on, signals from the control can lead to unintentional movements of the gripper and cause serious injuries or damage to property.

- When working on the universal gripper, make sure that the control unit and the pneumatic system are switched off and secured against being switched on again.
- Connect or disconnect the cables only when the control is switched off.
- Observe the operating instructions of the controller used!



Observe the safety instructions in  Chapter 2 „Safety instructions“ of these assembly instructions!

7.2 Commissioning of the modules

NOTICE

Danger of injury due to improper work!

The universal grippers are precision mechanical devices, these must be handled with the necessary care and cleanliness during all work.

- Commissioning may only be performed by qualified personnel!

Proceed carefully and follow the instructions step by step when commissioning the modules for the first time:

1. Vent the system slowly.
 2. Pay attention to the permissible values.
 - Payload
 - Movement frequency
 - Moment loads on the guide system
 3. First, make sure that there are no persons or tools in the working area.
 4. Perform test run:
 - Start with slow movements
 - Then continue under normal operating conditions
- ⇒ Commissioning is completed.

7.3 Setting up and retrofitting

CAUTION



Risk of injury due to incorrect operation of the system!

Incorrect operation during set-up work on the system can lead to unintentional start-up of the universal gripper and cause injuries.

- Adjusting and maintenance work may only be carried out by qualified personnel.
- Observe the operating instructions!

CAUTION



Risk of injury due to mounted components!

The gripper fingers are controlled electrically. Attachments can restrict the free movement of the universal gripper and lead to injuries.

- Make sure that the movement of the universal gripper is not restricted by mounted attachments.
- Take appropriate measures to ensure safe operation!

8 Fault elimination

8.1 Safety instructions for troubleshooting

WARNING



Danger of injury due to faulty troubleshooting!

Poorly performed troubleshooting work can lead to serious injuries and damage to property.

- Only use trained specialist personnel for troubleshooting.
- All work on the universal grippers must be carried out with the power supply cut off!

NOTICE

Risk of property damage due to uncontrolled movements!

There is a risk of damage to property if unusual movement behaviour of the universal gripper (e.g., hard knocks) is detected during normal operation.

- Stop the machine immediately and eliminate the cause without delay!



Also observe the safety instructions in  chapter 2 „Safety instructions“ in this manual.

8.2 Fault causes and remedy

The following table contains an overview of possible fault causes and how to proceed to eliminate them.

Fault	Possible cause	Remedy:
Gripper jaws do not move to end position	<ul style="list-style-type: none"> ▪ Payload too high ▪ Pressure too low ▪ Module defect ▪ Module incorrectly connected ▪ Throttle check valve fully closed 	<ul style="list-style-type: none"> ▪ Reduce payload ▪ Increase pressure to max. 8 bar ▪ Send module to Afag ▪ Check pneumatic connections ▪ Open the throttle check valve
Module audibly loses compressed air	<ul style="list-style-type: none"> ▪ Leakage from compressed air connection ▪ Leakage from cylinder 	<ul style="list-style-type: none"> ▪ Check closures on air connections, retighten if necessary ▪ Send module to Afag

9 Maintenance and care

9.1 General notes

The universal grippers are almost maintenance-free. Nevertheless, some maintenance work must be carried out to ensure an optimum operating condition of the universal gripper.

For maintenance, no further measures are required apart from the usual machine cleaning work.

9.2 Safety instructions for maintenance and repair

WARNING



Danger of injury due to improper maintenance!

Improperly carried out maintenance activities can cause considerable damage to property and serious injury.

- Only use trained specialist personnel to carry out the activities.
- Always wear personal protective equipment when carrying out maintenance and repair work!

WARNING



Risk of injuries due to uncontrolled parts movements!

Signals from the control system can trigger unintentional movements of the universal grippers, which can cause injury.

- Before starting any work on the universal gripper, switch off the control unit and secure to prevent it from being switched on.
- Observe the operating instructions of the controller used!
- Before starting any activities, switch off the media supply and secure it from being switched on again!



Also observe the safety instructions in  chapter 2 „Safety instructions“ in this manual.

9.3 Maintenance activities and maintenance intervals



- Observe the specified maintenance and care intervals. The intervals refer to a normal operating environment.

9.3.1 Overview of the maintenance points

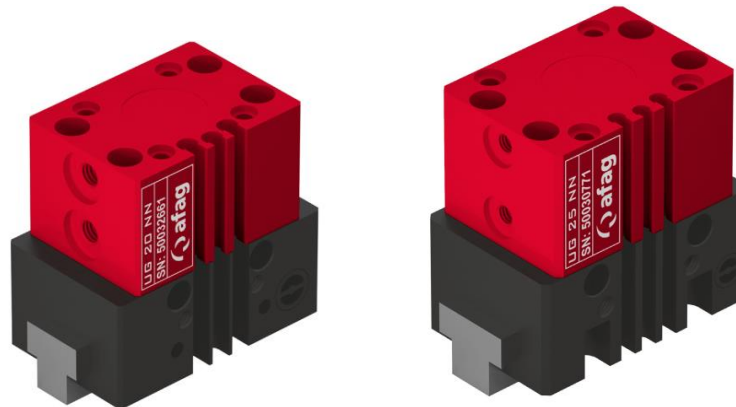



Fig. 10 Maintenance points universal gripper

No.	Maintenance point	Maintenance work	Interval	System [On/Off]	Remarks
1	Fastening elements	check 	Regularly	[Off]	- ▪ Check fastening elements for tight fit.
2	Module	Cleaning 	as required	[Off]	- ▪ Clean with a dry, lint-free cloth (the universal gripper must not be hosed down. Do not use aggressive cleaning agents).

9.3.2 Further maintenance

Further maintenance is not required, if the ambient conditions listed below are complied with:

- Clean working area
- No use of splash water
- No abrasive or process dust and vapours
- Environmental conditions as specified in the technical data

9.3.3 Compressed air specification

The universal grippers are lifetime lubricated and can be operated with lubricated or non-lubricated compressed air.

Compressed air specification
Dry (condensation-free)
Filtered (40 µm filter for oil-lubricated air)
Filtered (5 µm filter for oil-lubricated air)

If the universal grippers are operated with lubricated compressed air, we recommend that you use the following types of oil:

oil type	
Festo Special Oil	Shell Tellus Oel C 10
Avia Avilub RSL 10	Mobil DTE 21
BP Energol HPL 10	Blaser Blasol 154
Esso Spinesso 10	

Oil quantity: 5-10 drops of oil per 1000 ltr. Compressed air

Viscosity range: 9 to 11 mm²/s (= cST) at 40°C, ISO class VG 10 according to ISO 3448.

NOTICE

Risk of damage to property!

The operation of the rotary modules with oil-lubricated compressed air causes the factory primary lubrication to be washed out. Therefore, it is essential that the rotary modules continue to be operated with oil-lubricated compressed air in order to avoid damage to the rotary modules.

- Once the rotary modules have been operated with oil-lubricated compressed air, they **may never** be operated without oil-lubricated compressed air.

NOTICE

Risk of corrosion!

When used in ionised air environments (e.g., high voltage processors/ coronisation), the universal grippers may corrode.

- Regularly coat open flanges/shafts as well as guides and tongs with lubricant.
- We recommend monthly cleaning and lubrication according to Afag standard:
 - Staburax NBU8EP (flat guides)
 - Blasolube 301 (piston rod)

9.4 Spare parts and repair work

Afag Automation AG offers a reliable repair service. Defective universal grippers can be sent to Afag for warranty repair within the warranty period.

After expiry of the warranty period, the customer may replace or repair defective modules or wear parts himself or send them to the Afag repair service.



Please note that Afag does not assume any warranty for modules that have not been replaced or repaired by Afag!

CAUTION

Risk of injury when removing the universal gripper due to uncontrolled movements of the modules!

When disassembling the universal grippers from a system, there is a danger of uncontrolled movements.

- Disconnect the media supply (pneumatics) before removing the modules!
 - Disassembling should only be carried out by qualified personnel!
 - Only dismount the universal gripper when the control unit is switched off and secured!
-



10 Decommissioning, disassembly, disposal

The universal gripper must be properly dismantled after use and disposed of in an environmentally friendly manner.

10.1 Safety instructions for decommissioning and disposal

WARNING



Risk of injury due to improper decommissioning and disposal!

Improperly carried out activities can result in considerable material damage and serious injury.

- Only use trained specialist personnel to carry out the activities.
 - Disconnect the media supply (pneumatics) before removing the modules!
 - Only dismount the universal gripper when the control unit is switched off and secured!
-

10.2 Decommissioning

If the universal grippers are not used for a longer period, they must be properly commissioned and stored as described in  chapter 4.5.

10.3 Disposal

The universal gripper must be disposed of properly at the end of their service life and the raw materials used must be recycled. Observe the legal regulations and company requirements.

The universal gripper must not be disposed of as a complete unit. Dismantle the universal gripper and separate the various components according to type of material and dispose of them properly:

- Scrap the metallic materials.
- Hand over plastic parts for recycling.
- Sort the rest of the components by their material properties and dispose of them accordingly.

NOTICE

Risk to the environment due to incorrect disposal of the packaging material!

Environmental damage can be caused by improper disposal of the universal gripper.

- Electronic parts, electrical scrap, auxiliary and operating materials must be disposed of by approved specialist companies.
 - Information on proper disposal can be obtained from the responsible local authorities.
-

11 Declaration of incorporation

Declaration of incorporation

for partly completed machinery according to the Machinery Directive 2006/42/EC, Annex II, 1.B

The manufacturer hereby declares:

Afag Automation AG, Luzernstrasse 32, CH-6144 Zell

that the partly completed machine:

Product description	Universal gripper UG
Type:	UG 20 I UG 25

complies with the following essential health and safety requirements of the Machinery Directive 2006/42/EC at the time of declaration: 1.1; 1.1.1; 1.1.2; 1.2.3; 1.3.3; 1.3.6; 1.3.7.1.4.1; 1.5; 1.6; 1.6.1; 1.6.2; 1.6.4; 1.7; 1.7.4; 1.7.4.2.

Harmonised standards applied, in particular:	
EN ISO 12100:2010	Safety of machinery - General design principles - Risk assessment and risk reduction.

Note: The partly completed machinery must not be put into service until the machinery into which it is to be incorporated has been declared in conformity with the provisions of Machinery Directive 2006/42/EC.

The manufacturer undertakes to transmit, in response to a reasoned request by the national authorities, relevant technical documentation for the partly completed machinery.

The relevant technical documentation were created according to Annex VII, Part B of the above-mentioned Directive.

Authorised representative for compiling the technical documentation:

Niklaus Röthlisberger, Product Manager, Afag Automation AG, CH-6144 Zell

Zell, 31.05.2023

Adrian Fuchser



CEO Afag Gruppe

Klaus Bott



CTO Afag Gruppe

Afag Automation AG
Luzernstrasse 32
6144 Zell
Switzerland
T +41 62 959 86 86
sales@afag.com

Afag GmbH
Werner-von-Braun-Straße 1
92224 Amberg
Germany
T +49 9621 650 27-0
sales@afag.com

Afag Engineering GmbH
Gewerbestraße 11
78739 Hardt
Germany
T +49 7422 560 03-0
sales@afag.com

Afag Automation Americas
Schaeff Machinery & Services LLC.
883 Seven Oaks Blvd, Suite 800
Smyrna, TN 37167
USA
T +1 615 730 7515
nashville@afag.com

Afag Automation APAC
Afag Automation Technology (Shanghai) Co., Ltd.
Room 102, 1/F, Bldg. 56, City Of Elite
No.1000, Jinhai Road, Pudong New District
Shanghai, 201206
China
T +86 021 5895 8065
shanghai@afag.com