

Pumping made simple.



Penberthy Jet Pumps

The easy way to pump, mix or heat a wide range of liquids and gases, regardless of the motive media.



A WORLD OF EXPERIENCE

The Penberthy brand has been recognized for global leadership in the design and manufacture of innovative products for the process industries since 1886. Now part of Emerson, Penberthy products encompass the broadest possible range of level and flow indication products for local visual indication, which includes liquid level gages, sight flow indicators, magnetic level gages, electronic level instruments; and jet pumps for use in pumping, mixing or heating a wide range of liquids and gases.

State-of-the-art manufacturing facilities combine lean manufacturing principles with continuous quality auditing and a zero harm work ethic, allowing us to maintain the highest standards of product reliability and quality. Local sales offices and after sales support teams situated in 32 countries worldwide ensure we are on hand to meet the day-to-day flow control requirements of your plant or process.

Our network of sales representatives, distributors and agents offices provides local spares inventory, product support and training for each market, with access to our global support services, design, engineering and manufacturing expertise where required.





PENBERTHY JET PUMPS

PENBERTHY JET PUMPS PROVIDE PRACTICAL, SIMPLE, AND COST-EFFECTIVE ALTERNATIVES TO PROCESS INDUSTRIES TO PUMP, MIX OR HEAT A RANGE OF LIQUIDS AND GASES WITH A VARIETY OF MOTIVE MEDIA.

In addition to pumping, mixing, and heating liquids, Penberthy jet pumps also can evacuate gases, create a vacuum, boost suction pressures and mix granular solids with liquids.

The jet pumps are simple in design with no moving parts to wear out, they require no lubrication, are virtually maintenance-free and are easy to install without special structures or foundations.

All Penberthy jet pumps are self-priming and are available in a variety of materials to suit the specific characteristics of the liquids involved in the process. The critical flow paths of all these jet pumps are machined smoothly with no abrupt turns or steps. This design produces the most efficient flow during the motive function.

SPECIFICATIONS

Fabrication

- Cast
- Fabricated
- Non-metallic

Material

- 316 Stainless steel
- Bronze
- Carbon steel
- Chlorinated polyvinyl chloride (CPVC)
- Iron
- Polyvinyl chloride (PVC)
- Polypropylene (PP)
- Glass-filled PP
- Polyvinylidene difluoride (PVDF) (Kynar™)

Sizes

1/4" to 4" and up

PENBERTHY JET PUMP DESIGN

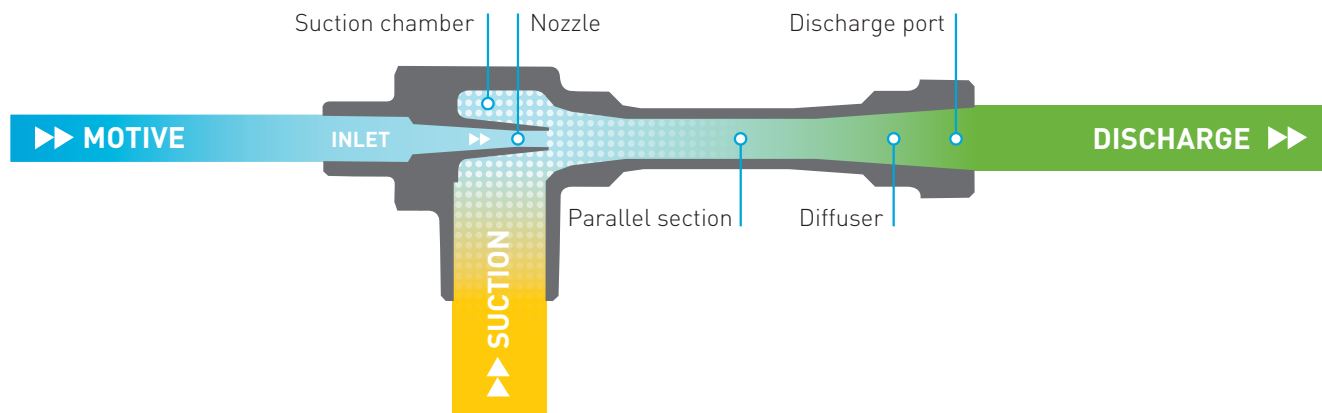

PRINCIPLE OF OPERATION

PRINCIPLE OF OPERATION

While Penberthy jet pumps may differ in appearance, their basic operation is the same. Also known as eductors, jet pumps operate on the principles of fluid dynamics. An operating fluid medium, which is referred to as the MOTIVE, placed under pressure, enters the inlet and is forced through the nozzle where it is converted into a high-velocity stream. This high-velocity stream decreases the pressure in the suction chamber, creating a partial vacuum that draws the suction material into the chamber where it is entrained by the motive medium. Once the SUCTION stream is drawn in, shear between the motive medium and the transported material causes both media to be intermixed and pumped out the DISCHARGE outlet, dispelled at a pressure greater than that of the SUCTION stream but lower than that of the MOTIVE. This basic principle of fluid dynamics is what makes Penberthy jet pumps work.

MOTIVE:

This function is the power phase of the pumping operation. At this stage, the velocity of the motive medium increases as it passes through a nozzle. This phase of the pumping operation takes advantage of the kinetic properties of the motive medium, whether it is liquid, steam or gas. Because of this, design differences may exist within the motive connection of the jet pump. For instance, jet pumps with liquid motives use a converging nozzle, since liquids usually cannot be compressed. On the other hand, jet pumps with gas or steam motives use converging/diverging nozzles to achieve trans-sonic flow velocity. The critical flow paths of all Penberthy jet pumps are machined smoothly with no abrupt turns or steps in order to produce the most efficient flow during the motive function. Without this direct flow design and smooth interior surface, the jet pump would not operate at peak efficiency.

SUCTION:

This connection is where the pumping action takes place. The high velocity stream of the motive causes a drop in pressure in the suction chamber. This allows pressure in the suction vessel to push a liquid, steam or gas into the suction chamber of the jet pump. This, in turn, is entrained by the high-velocity motive stream emerging from the inlet nozzle.

DISCHARGE:

As the motive flow combines with the suction medium, some kinetic energy of the motive is transferred to the suction, mixing and discharging at a reduced pressure. The amount of pressure that can be recovered depends on the ratio of motive flow to suction flow, plus the amount of suction pressure built up in the suction vessel. Kinetic energy is converted back to pressure as the mixed media passes through the diverging taper and is discharged from the pump.

JET PUMP

PROCESS APPLICATION GUIDE

AVAILABLE MODELS

The jet pump models are arranged by use (application) for easy identification.

Below is a guide to jet pump applications by suction (transport) medium and motive (operating) medium.

TRANSPORT MEDIUM SUCTION	OPERATING MEDIUM MOTIVE		
	LIQUID	STEAM	GAS (Air)
LIQUID	Models LL, LM, LH P6-7 Liquid transfer Pump from tank or sump Dilute in-line Mix or blend in-line Lift or elevate liquids Boost suction pressure to centrifugal pump	Models GL, GH P8-9 Liquid transfer Pump from tank or sump Lift or elevate liquids	Models GL, GH (by request) Liquid transfer Pump from tank or sump Lift or elevate liquids
	Models CTE, TME P18-19 In-tank mixing Destratify	Models NWH, CTE, XL-32 P14-15 In-tank heating	
STEAM	Models ELL, HLM, SRH P16-17 Heat liquids in-line	Models GL, GH, U, L, 2NC P 10-11 Exhaust from vessel Evacuate from vessel Produce vacuum	Models GL, GH, U, L, 2NC P 10-11 Exhaust from vessel Evacuate from vessel Produce vacuum
	Models LM, ELL, FL P16-17 Exhaust from vessel Produce vacuum		
GAS	Models LM, ELL, FL P12-13 Aeration of vessel Evacuate from vessel Prime pump	Models GL, GH, U, L, 2NC P10-11 Exhaust from vessel Evacuate from vessel Produce vacuum	Models GL, GH, U, L, 2NC P10-11 Exhaust from vessel Evacuate from vessel Produce vacuum
	Models LM, ELL, FL P12-13 Exhaust from vessel	Models GL, GH P10-11 Prime pump	Models GL, GH P10-11 Prime pump
SOLIDS	Models LL, LM, LH P6-7 Transport liquid slurries Dilute or mix in-line	Models GL, GH P8-9 Transport liquid slurries Humidify	
	Models LM, ELL P12-13 Transport powders	Models NWH, CTE, XL-32 P14-15 In-tank heating	
	Model CTE, TME P18-19 In-tank mixing Suspension in liquid tanks Sweep bottom in liquid tanks		
	Model 62DP P20-21 Wetting solids		

Model **LM**



PUMPING LIQUID LIQUID MOTIVE

MODELS AVAILABLE

LL, LM, LH

DESCRIPTION

One of the most common applications is to pump liquids using a liquid motive. This is perhaps one of the most recognized uses for a jet pump in the process industry. Like all Penberthy jet pumps, liquid motive jet pumps are simple in design with no moving parts to wear out, they require no lubrication, are virtually maintenance-free and are easy to install without special structures or foundations. All Penberthy jet pumps are self-priming and are available in a variety of materials to suit the specific characteristics of the liquids involved in the process.

TYPICAL APPLICATIONS

Models LL, LM and LH operate well in many liquid pumping applications.

Industries that benefit from using these jet pump models include chemical processing, textile manufacturing, petroleum production and refining, power generation, mining, nuclear power generation, waste water treatment and processing, construction, distilling and potable water processing.

Applications within these industries include handling condensate, multiplying flow volume, making dilutions, pumping wells and brine solutions, circulating solutions, emptying cesspools, extracting solvents, draining cellars and tanks,

pumping out barges, acidifying, causticizing oils, producing emulsions and elevating and lifting liquids.

Sizing and performance information for these jet pumps is available in our Pumping Liquids datasheet VCTDS-04502, which is downloadable from our website.

LL, LM, LH MODEL SPECIFICATIONS

Based on water at Sp. Gr. = 1.0	LL LOW HEAD	LM MEDIUM HEAD	LH HIGH HEAD
Motive medium pressure range	15-200 psig (100-1380 kPag)	15-200 psig (100-1380 kPag)	15-200 psig (100-1380 kPag)
Nominal motive medium pressure- psig/psig of discharge (kPag/kPag)	2 psig (15 kPag) Sp.Gr.1.0	1.5 psig (10 kPag) Sp.Gr.1.0	1 psig (7 kPag) Sp.Gr.1.0
Discharge head pressure range	to 50 ft. (15.2 m)-H ₂ O	40-80 ft. (12.2-24.4 m)-H ₂ O	80 ft. (24.4m) or more-H ₂ O
Suction lift	to 27 ft. (8.2 m)-H ₂ O	to 27 ft. (8.2 m)-H ₂ O	to 27 ft. (8.2 m)-H ₂ O
Minimum NPSH	3 ft. (0.9 m)-H ₂ O	3 ft. (0.9 m)-H ₂ O	3 ft. (0.9 m)-H ₂ O

LL, LM, LH MODEL CONSTRUCTION DATA

SIZES	STANDARD MATERIALS
1/2A - 4"	Cast: Low lead bronze, iron, carbon steel, 316 STS
4" & up	Fabricated: Carbon steel, 316 STS
1/2A - 3"	Non-metallic: PVC, PP, PVDF (Kynar™)

1 LIFTING OR ELEVATING LIQUIDS

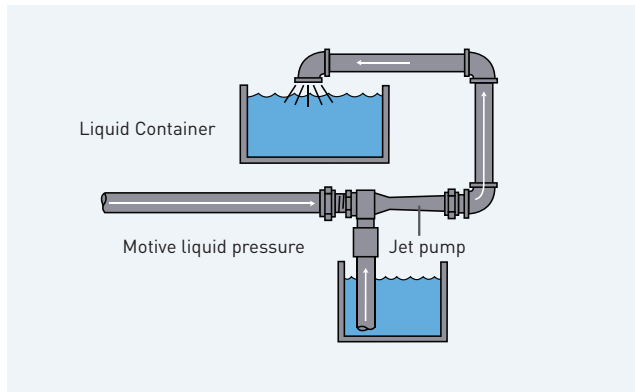

*Maximum head dependent on jet pump capability & pressure available.

2 DRAINING SUMP OR WELL

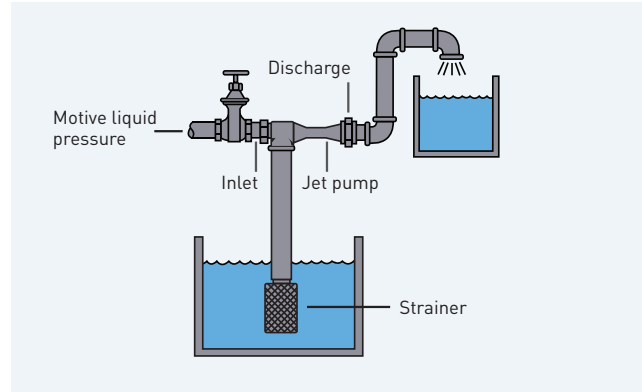

3 BLENDING

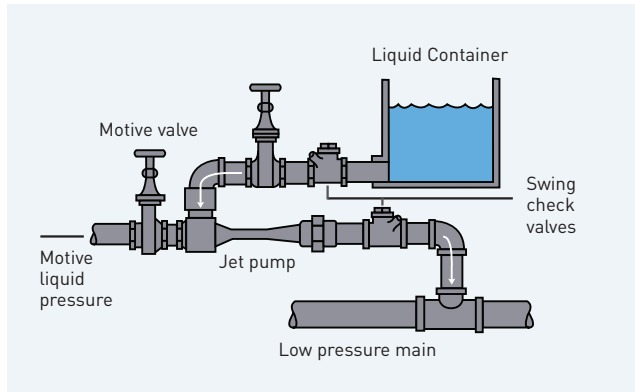

4 HANDLING GRANULAR SOLIDS WITH LIQUIDS

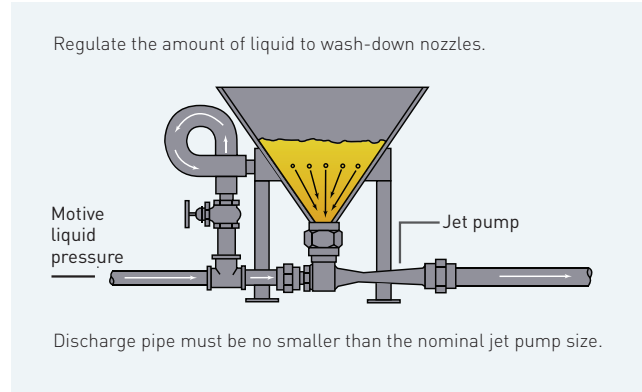

Clogging or bridging of materials is likely unless wash down nozzles are provided. They also help seal the suction and increase capacity.

5 BOOSTING SUCTION PRESSURE TO CENTRIFUGAL PUMP

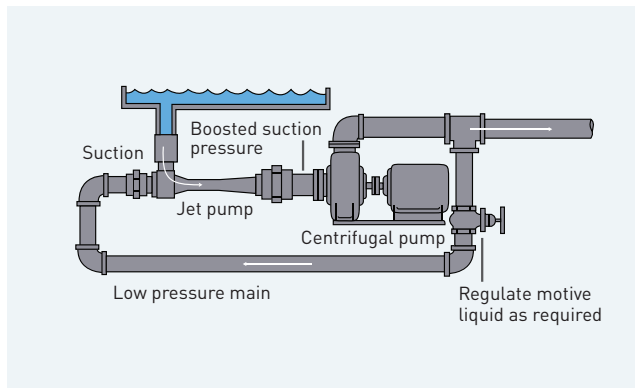

Model **GL**



PUMPING LIQUID STEAM MOTIVE

MODELS AVAILABLE

GL, GH

DESCRIPTION

Another method of pumping liquids is to use steam as the motive. This type of jet pump works best in applications where a minimal amount of infusion of the motive media with the liquid to be transported is required.

Quiet operating steam motive jet pumps, like liquid motive pumps, are designed simply with no packing glands and no moving parts to wear out. These pumps are attractive to the process industry because of their low initial cost, ease of operation and consistently low maintenance cost.

TYPICAL APPLICATIONS

Industries that benefit from these models include chemical processing, textile manufacturing, food processing, water treatment and petroleum production and refining.

Applications within these industries include distilling and brewing; agrochemical processing; pharmaceutical processing; sterilization; heating, ventilating and air conditioning (HVAC); pulp and paper manufacturing; power generation; mining; plastics production; automotive manufacturing; plating; groundwater evaluation and clean-up operations.

Sizing and performance information for these jet pumps is available in our Pumping Liquids datasheet VCTDS-04502, which is downloadable from our website.

GL, GH MODEL SPECIFICATIONS

	GL LOW HEAD	GH HIGH HEAD
Motive medium	Steam	Steam
Motive steam pressure to elevate liquid 50 ft. (15.2 m)	150 psig (1035 kPag)	75 psig (520 kPag)
Motive steam pressure range	60-150 psig (415-1035 kPag)	35-150 psig (240-1035 kPag)
Suction lift – water temp. to 120°F (49°C)	to 20 ft. (6.1 m)	to 20 ft. (6.1 m)
Minimum NPSH	13 ft. (4 m)	13 ft. (4 m)

GL, GH MODEL CONSTRUCTION DATA

SIZES	STANDARD MATERIALS
1/2A - 4"	Cast: Low lead bronze, iron, carbon steel, 316 STS
4" & up	Fabricated: Carbon steel, 316 STS

1 DRAINING SUMP OR WELL

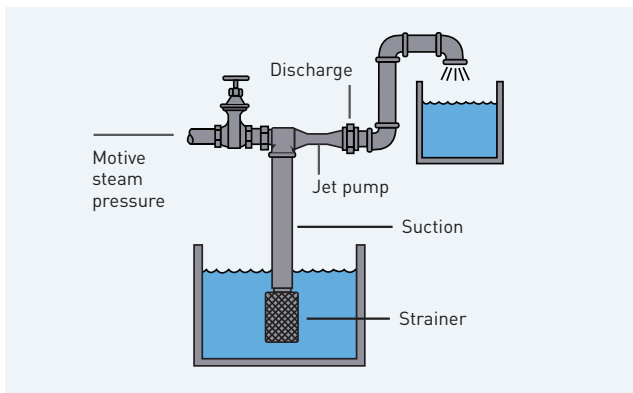

2 LIFTING OR ELEVATING LIQUIDS

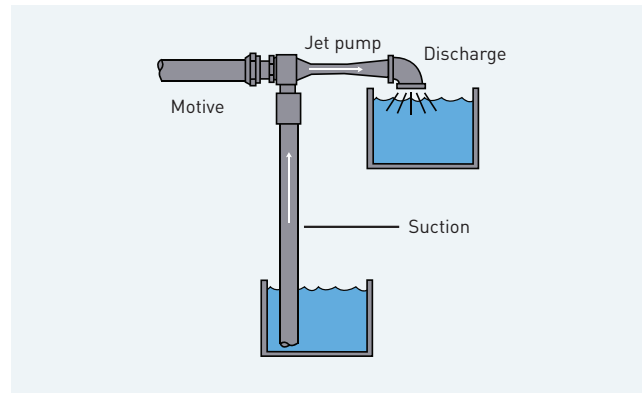

3 AERATION OR AGITATION

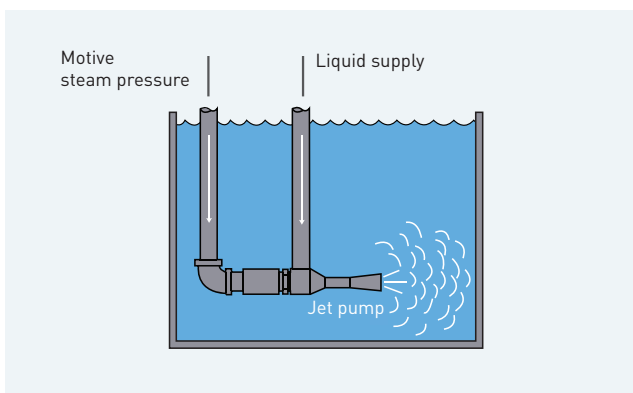

4 PRODUCING VACUUM

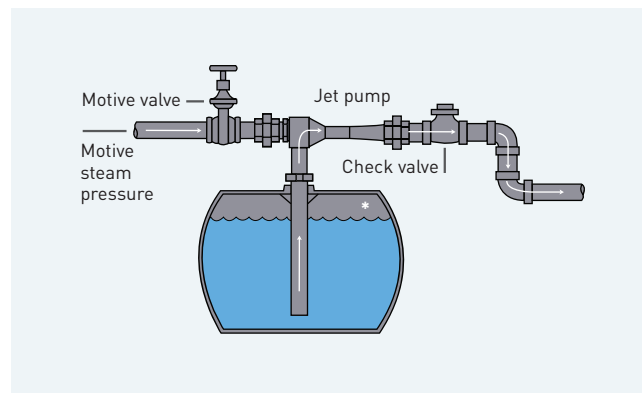

*Airtight container capable of withstanding full vacuum. Discharge line must never be smaller than jet size. In some applications, a couple of elbows or a swing check valve is necessary to ensure that the ejector will seal.

5 PRIMING CENTRIFUGAL PUMPS

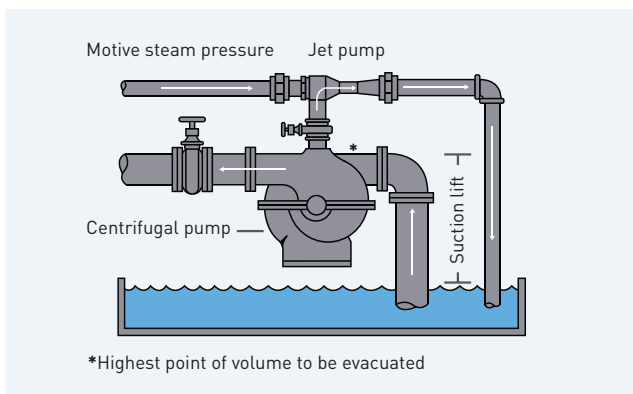

Terminate discharge pipe below liquid level or add a couple of elbows or a swing check to provide enough back pressure for ejector to seal.

Model **GL**



PUMPING GAS STEAM OR GAS MOTIVE

MODELS AVAILABLE

GL, GH, U, L, 2NC

DESCRIPTION

Penberthy jet pumps can also use steam or a gas (air) as the operating medium for exhausting, evacuating, or priming operations. These models operate at pressures from 140 to 830 kPag (20 to 120 psig), the overall capacity being slightly higher when using air as the operating medium. Models U and L are single-stage ejectors, while model 2NC is a dual-stage, noncondensing ejector using steam as the operating medium.

These steam and gas motive jet pumps meet the industry's most stringent requirements while providing a simple and low-cost method of transporting gases. These units operate flawlessly, even in the harshest work environments, and provide maintenance-free pumping capabilities.

TYPICAL APPLICATIONS

Industries that benefit from these models include chemical processing, textile manufacturing, food processing, petroleum production and refining, sterilization and HVAC.

Applications within these industries include creating vacuums, exhausting vapors from process systems, evacuating tanks and vessels, priming, fume removal, fluid concentration, humidifying and drying.

Sizing and performance information for these jet pumps is available in our Pumping Gases datasheet VCTDS-04503, which is downloadable from our website.

GL, GH, U, L, 2NC MODEL SPECIFICATIONS

	GL	GH	U	L	2NC
Motive medium	Steam, gas	Steam, gas	Steam	Steam	Steam
Motive medium pressure range	60-120 psig (415-830 kPag)	20-80 psig (140-550 kPag)	80-200 psig (550-1380 kPag)	80-200 psig (550-1380 kPag)	100-200 psig (690-1380 kPag)
Application range, inches Hg Abs (kg/cm ² Abs)	6-30 (.18-1.04)	6.5-30 (.2-1.04)	6-12 (.18-.36)	3-6 (.09-.18)	0.5-3 (.002-.09)
Functions	Evac/Exh/Prime	Evac/Exh/Prime	Evac/Exh	Evac/Exh	Evac/Exh

GL, GH, U, L, 2NC MODEL CONSTRUCTION DATA

SIZES	GL, GH STANDARD MATERIALS
1/2A - 4"	Cast: Low lead bronze, iron, carbon steel, 316 STS
4" & up	Fabricated: Carbon steel, 316 STS
1/2A - 3"	Non-metallic: PVC, PP, PVDF (Kynar™)

SIZES	U, L, 2NC STANDARD MATERIALS
1H-18H	Cast: Carbon steel, iron body, 316 STS nozzle or all 316 STS

1 PRODUCING VACUUM

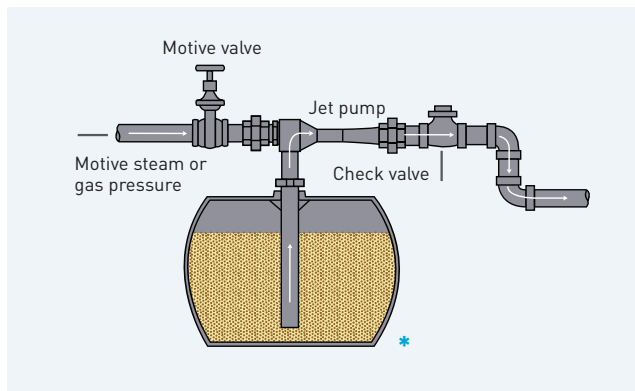

*Airtight container capable of withstanding full vacuum. Discharge line must never be smaller than ejector size. In some applications, a couple of elbows or a swing check valve is necessary to ensure that jet pump will seal.

2 REDUCING PRESSURE

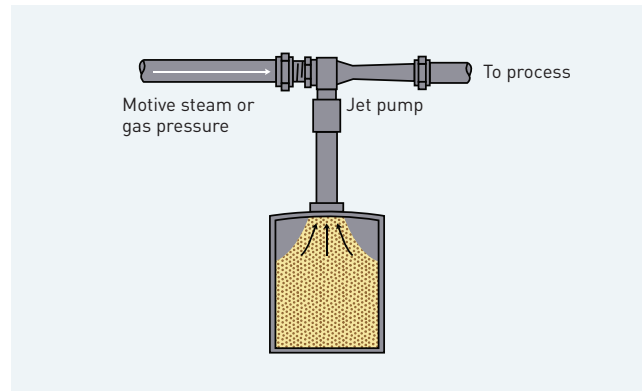

3 MOVING GASES

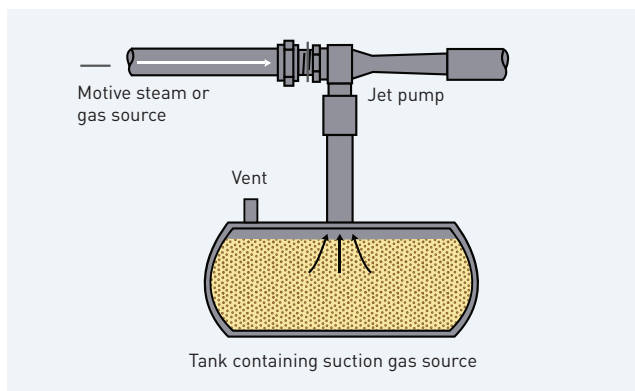

Model **LM**



PUMPING GAS LIQUID MOTIVE

MODELS AVAILABLE

LM, ELL, FL

DESCRIPTION

In some process operations it is necessary to evacuate or move a gas. Models LM, ELL and FL are perfect for many gas pumping operations where more costly and complicated pumps have been used.

These jet pumps are a low-cost alternative when compared to other methods of moving gases. Installation is easy and the units are compact and easily adapted to almost any installation requirements.

These specially designed liquid motive jet pumps offer many advantages over other methods of evacuating or moving gases. The simple design for these units features no moving parts, which means trouble-free operation and no need for lubrication. As a result, there is little chance of the jet pump wearing out.

TYPICAL APPLICATIONS

Industries that benefit from these models include textile manufacturing, chemical processing, food processing, water treatment, petroleum production, sterilization, tire making, HVAC and distilling and brewing.

Applications within these industries include creating a vacuum, evacuating gases from tanks and vessels, scrubbing a gas to remove contaminants, removing fumes, and condensing, drying, distilling and deaerating gas.

Sizing and performance information for these jet pumps is available in our Pumping Gases datasheet VCTDS-04503, which is downloadable from our website.

LM, ELL, FL MODEL SPECIFICATIONS

	LM	ELL	FL
Motive medium	Liquid	Liquid	Liquid
Motive medium pressure range	20-200 psig (140-1380 kPag)	20-200 psig (140-1380 kPag)	20-100 psig (140-690 kPag)
Application range, inches Hg Abs (kg/cm ² Abs)	1-27 (.03-.93)	1-27 (.03-.93)	27-30 (.93-1.04)
Functions	Evac/Exh/Prime	Evac/Exh/Prime	Exh

LM, ELL, FL MODEL CONSTRUCTION DATA

SIZES	LM,ELL STANDARD MATERIALS
1/2A - 4"	Cast: Low lead bronze, iron, C. steel, 316 STS
4" & up	Fabricated: Carbon steel, 316 STS
1/2A - 3"	Non-metallic: PVC, PP, PVDF (Kynar™)

SIZES	FL STANDARD MATERIALS
1A - 4B	Cast: Iron, carbon steel, 316 STS

1 PRODUCING VACUUM

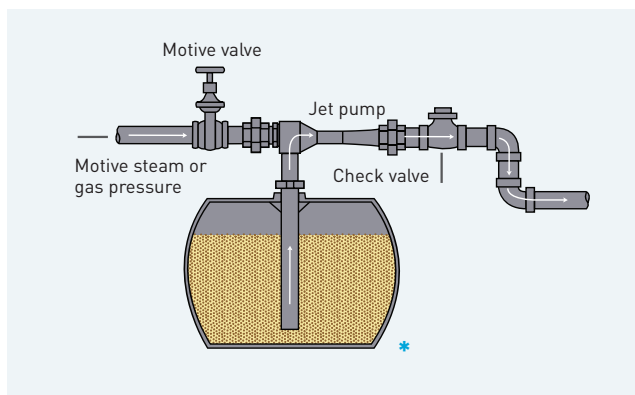

*Airtight container capable of withstanding full vacuum. Discharge line must never be smaller than ejector size. In some applications, a couple of elbows or a swing check valve is necessary to ensure that the ejector will seal.

2 MOVING GASES

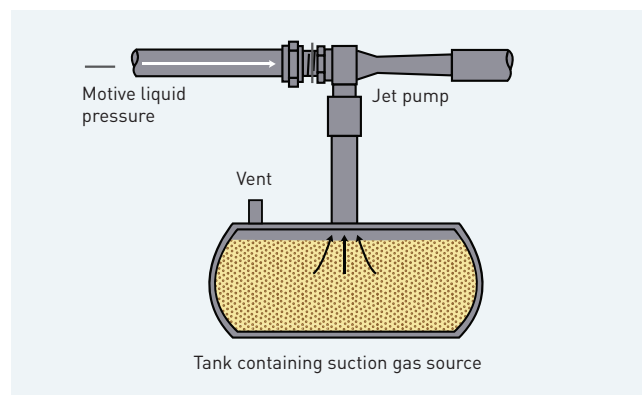

3 REDUCING PRESSURE

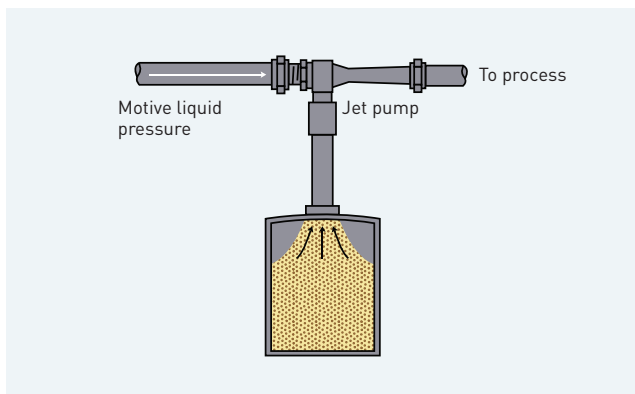

4 AERATION OR AGITATION

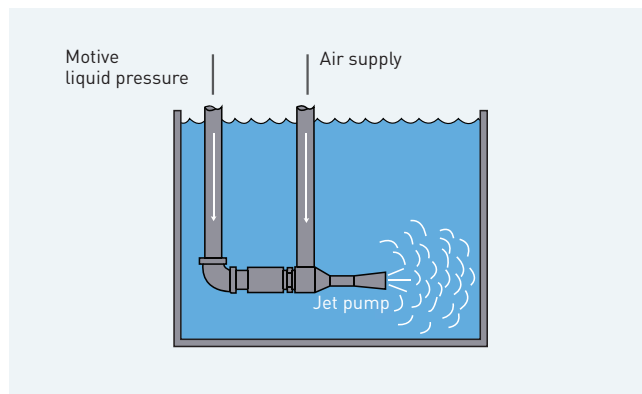



HEATING LIQUIDS IN-TANK

MODELS AVAILABLE

NWH, CTE and XL-32

DESCRIPTION

Penberthy jet pump in-tank heaters optimize and streamline an operation by completing two jobs at the same time—heating and circulating a mixture. There is a definite benefit to being able to heat a liquid in an open tank. Open tank heaters that are installed submerged in a tank are especially suited for cooking, heating and circulating liquids. These models also maximize the condensation of steam into operating liquids to provide heat fluid.

Because these models operate on a simple heat transfer principle, they are efficient and cost-effective. Model NWH is an inexpensive, basic heater. Model CTE is more versatile and produces strong mixing during the heating process. Model XL-32 provides the highest steam flow for a pipe size and quiet operation with as little as 3 psig of steam pressure. The CTE, NWH, and XL-32 produce temperature rise up to 49°C (120°F) with a final tank temperature of 71°C (160°F).

TYPICAL APPLICATIONS

Applications for these models include continuous heating, cooking grain, direct contact heat transfer, cooking mash, cooking starch and homogeneous liquid and temperature distribution throughout a tank. With imaginative engineering, uses for these units are virtually endless.

Sizing and performance information for these jet pumps is available in our Heating Liquids datasheet VCTDS-04504, which is downloadable from our website.

NWH, CTE, XL-32 and RJ MODEL SPECIFICATIONS

	NWH water heater	CTE	XL-32 heater
Motive steam pressure	up to 120 psig (830 kPag)	up to 140 psig (966 kPag)	up to 140 psig (966 kPag)
Max. water temp. rise (ΔT)	up to 120°F (49°C)	up to 120°F (49°C)	up to 120°F (49°C)
Max. final tank temp.	up to 160°F (71°C)	up to 160°F (71°C)	up to 160°F (71°C)

NWH, CTE and XL-32 MODEL CONSTRUCTION DATA

SIZES	NWH STANDARD MATERIALS
1/4 - 2"	Cast: Low lead bronze, carbon steel, 316 STS

SIZES	CTE STANDARD MATERIALS
3/8 - 4"	Cast: Low lead bronze, iron, carbon steel, 316 STS
4" & up	Fabricated: Carbon steel, 316 STS

SIZES	XL32 STANDARD MATERIALS
1/2 - 2"	Cast: Low lead bronze

1 HEATING LIQUID IN-TANK WITH MODEL NWH

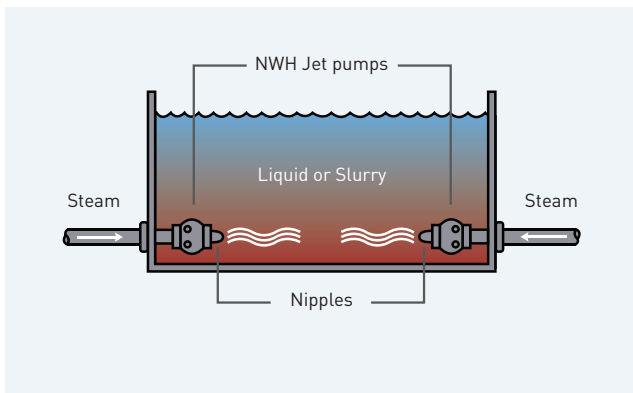

2 HEATING LIQUID IN-TANK WITH MODEL CTE

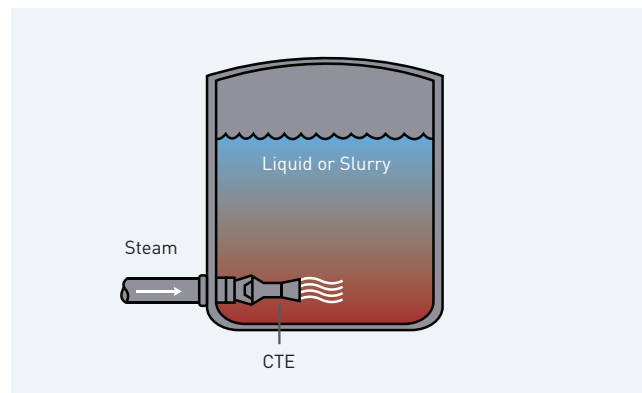

3 HEATING LIQUIDS WITH CIRCULATING TANK EDUCTORS

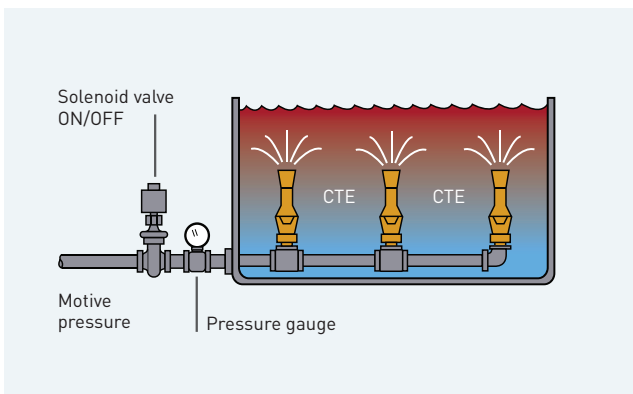

4 HEATING LIQUIDS IN OPEN TANK WITH XL32 HEATER

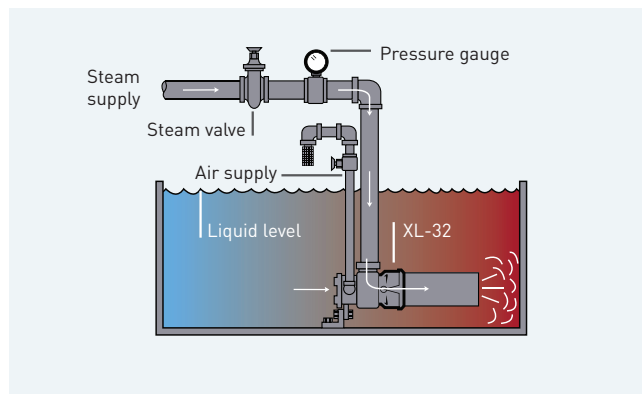

Models **ELL** and **SRH**



HEATING LIQUIDS IN-LINE

MODELS AVAILABLE

ELL, HLM, SRH

DESCRIPTION

Penberthy in-line mixers can heat in-line while transporting the process media. Steam jet heaters optimize the condensation of steam into the motive medium to heat the fluid.

Models ELL and HLM are ejector-type heaters capable of operating at steam pressures lower than the operating liquid. They have much higher thermal input than a comparable SRH model, while incurring a higher inlet-to-discharge pressure drop.

The SRH (steam ring heaters) are compact, in-line units with low pressure drop. SRH units inject steam through an opening in an enlargement in the unit. They correct temperature quickly and quietly. Also, because the liquid flow area is unrestricted, pressure drop within the nozzle is minimized.

TYPICAL APPLICATIONS

Industries that benefit from these models include food processing, petroleum production and refining, chemical processing, distilling and brewing and many other process operations.

Sizing and performance information for these jet pumps is available in our Heating Liquids datasheet VCTDS-04504, which is downloadable from our website.

ELL, HLM, SRH MODEL SPECIFICATIONS

	ELL Low steam pressure	HLM High steam pressure	SRH Steam ring heater
Steam pressure	up to 45 psig (310 kPag)	up to 120 psig** (830 kPag)	up to 150 psig (1035 kPag)
Max. water temp. rise (ΔT)*	up to 182°F (83°C)	up to 216°F (102°C)	up to 200°F (93°C)
Max. capacity	5000 gpm (18925 lpm)	5000 gpm (18925 lpm)	500 gpm (1893 lpm)

* Based on 60°F (16°C) inlet water

** Maximum steam pressure for iron body material, 60 psig (414 kPag)

ELL, HLM, SRH MODEL CONSTRUCTION DATA

SIZES	ELL, HLM STANDARD MATERIALS
1/2 A - 4"	Cast: Low lead bronze, iron, C. steel, 316 STS
4" & up	Fabricated: Carbon steel, 316 STS

SIZES	SRH STANDARD MATERIALS
1 1/2, 2, 3, 6"	Flanged: Low lead bronze, iron, C. steel, 316 STS

1 PARTS WASHER

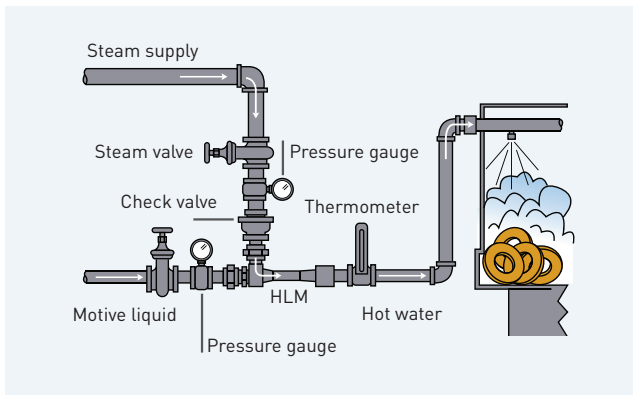

2 HEATING LIQUID IN-TANK

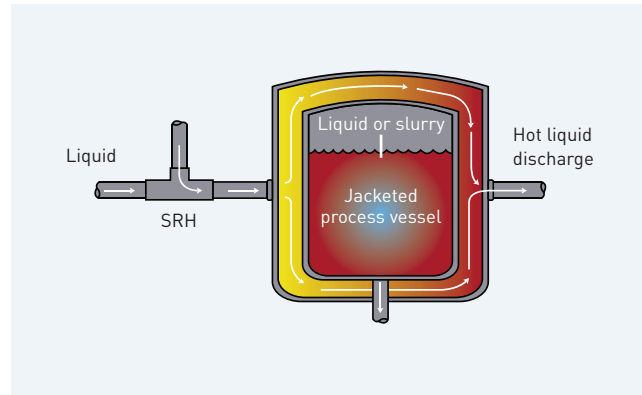

3 HEATING LIQUID IN-LINE

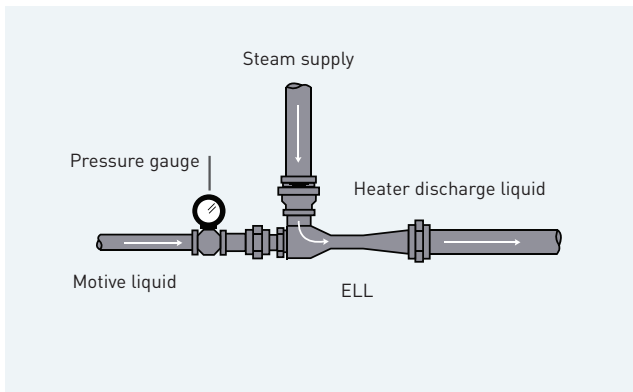

4 ADDING STEAM TO A LARGE FLOW OF WATER

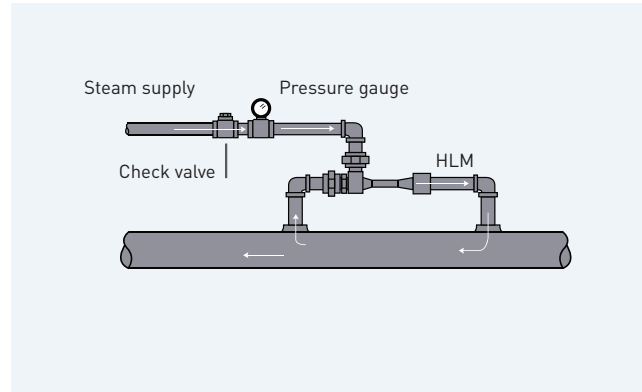

Steam pressure must be higher than liquid pressure

5 CIRCULATING HOT WATER

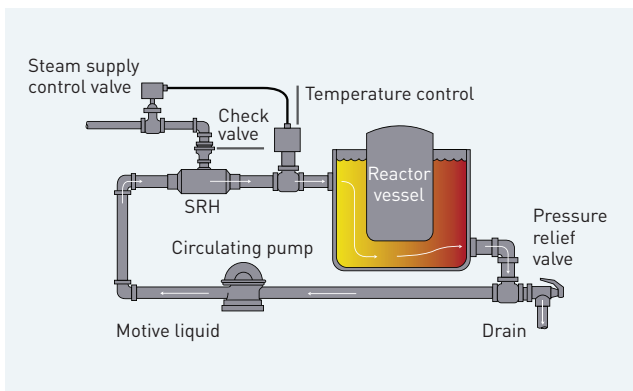

Models **TME** and **CTE**



MIXING LIQUIDS IN-TANK

MODELS AVAILABLE

CTE and TME

DESCRIPTION

Models CTE and TME are known as in-tank mixers. These units are a low-cost alternative to other mechanical mixing methods, and they provide a more thorough mixing action than either mechanical mixing or air sparging.

Models CTE and TME provide efficient and low-cost liquid and slurry mixing. The flow pattern is easily controlled and integrates substances in a variety of viscosities and liquids. Slurries that contain abrasive solids can deteriorate

mechanical mixer blades, increasing maintenance and downtime. But the Penberthy in-tank mixers are inherently non-clogging, they have no moving parts and require little or no maintenance.

TYPICAL APPLICATIONS

Industries that benefit from these models include chemical processing, food processing, electroplating, fertilizer and agrochemical processing and petrochemical processing.

Applications within these industries include hazardous waste and waste water processing, cooling tower circulation, tank truck agitation,

additive infusion, blended solution agitation, plating tank agitation and separation prevention of non-mixable liquids or stratification of dissimilar liquids.

Sizing and performance information for these jet pumps is available in our In-tank Mixers datasheet VCTDS-04505, which is downloadable from our website.

CTE,TME MODEL SPECIFICATIONS

	CTE Circulating Tank Eductor	TME Tank Mixing Eductor
Pressure differential of inlet to tank pressure	10-100 psig (70-690 kPag)	10-50 psig (70-345 kPag)
Mixing ratio	3:1	4:1
Max. operating liquid viscosity	up to 2,000 cPs	up to 2,000 cPs

CTE , TME MODEL CONSTRUCTION DATA

SIZES	CTE STANDARD MATERIALS
3/8 - 4"	Cast: Low lead bronze, iron, C. steel, 316 STS
4" & up	Fabricated: Carbon steel, 316 STS
3/8 - 3"	Non-metallic: PVC, PP PVDF (Kynar™)

SIZES	TME STANDARD MATERIALS
3/8, 1/2, 3/4, 1, 1 1/2"	Non-metallic: 25% glass-filled PP

1 MIXING TWO LIQUIDS (MULTIPLE TME)

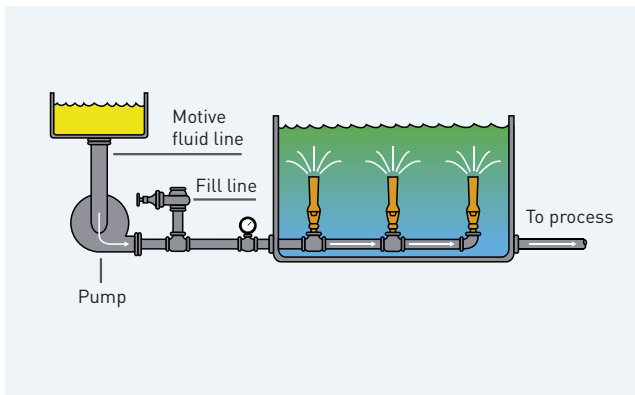

2 RECIRCULATING TANK CONTENTS (MULTIPLE CTE)

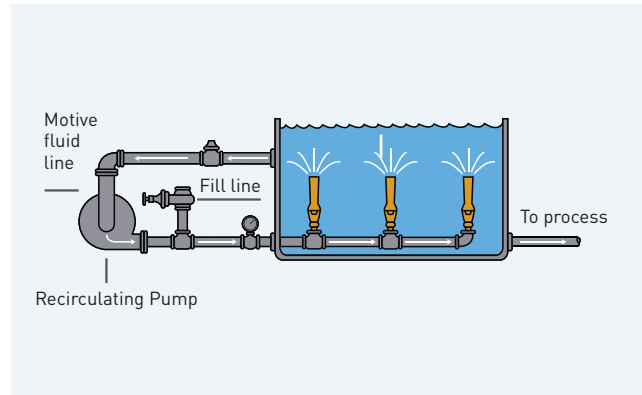

3 MIXING AGROCHEMICALS

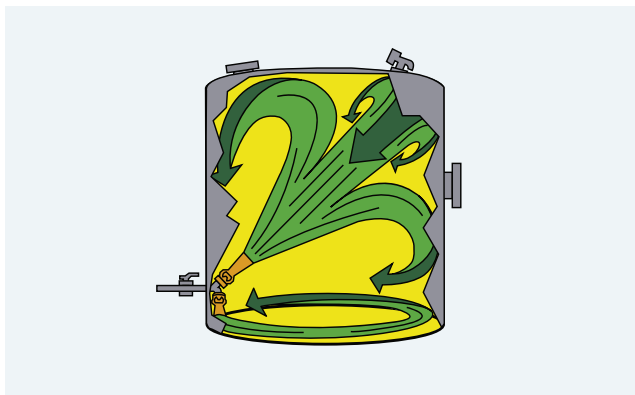

MIXING CONFIGURATIONS

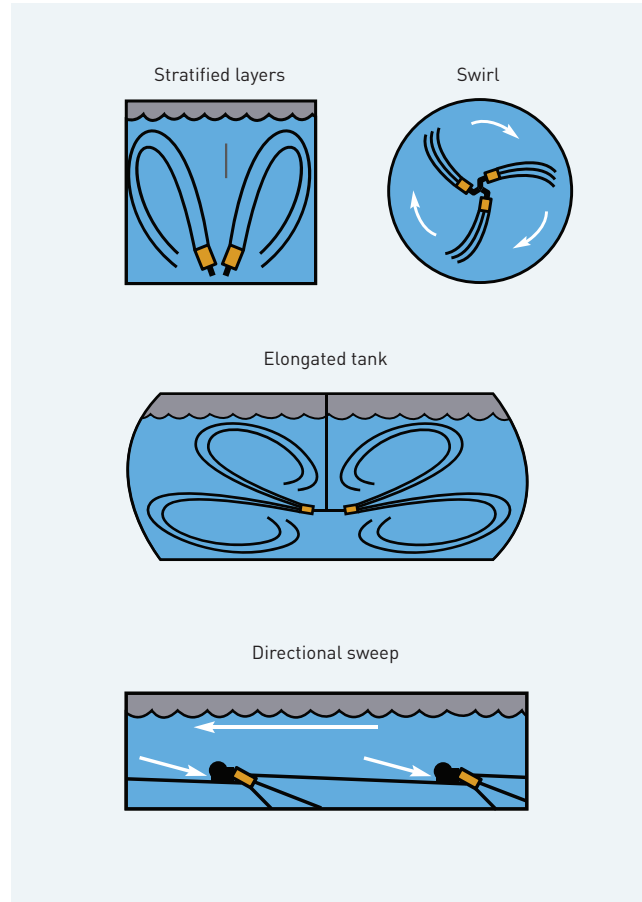

4 ELECTROCOATING

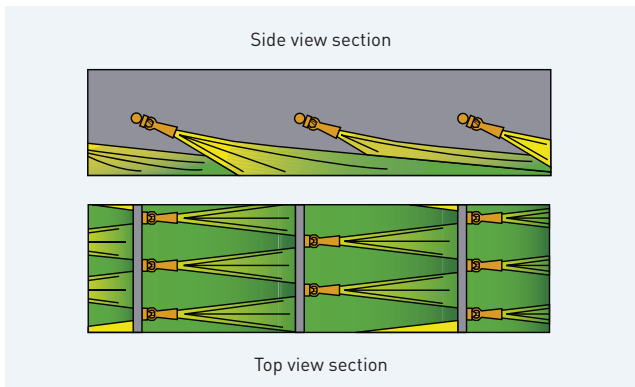

WETTING SOLIDS FLOCCULANT DISPERSAL

MODEL AVAILABLE
62DP

DESCRIPTION

When powder must be combined with water to create chemical concentrations, Model 62DP flocculant dispersers provide the perfect mix. Dispersers can effectively wet 2.27 kg (5 lb) of powder for every 37.8 to 56.7 L (10 to 15 gal.) of water supplied to the unit, resulting in a 4 to 6% concentration of flocculant in the water. This mixture must then be mixed thoroughly with additional water until the powder is dissolved completely and the desired solution concentration obtained. Water supply pressures from 20 to 100 psig (1.37 to 6.89 barg) can be used.

The 62DP is a 'small job' device and operates in a similar manner to a ring jet; the nozzle having the same basic characteristics.

SPECIFICATIONS

The table below shows the flow rate of water in gpm at various supply pressures with standard orifice settings.

TYPICAL APPLICATIONS

Once considered a flocculant disperser for use primarily in wastewater treatment applications, the 62DP could be used for any dry powder or granular product.

Sizing and performance information for these jet pumps is available in our In-tank Mixers datasheet VCTDS-04554, which is downloadable from our website.

62DP WATER FLOW RATE IN GPM

PIPE SIZE	WATER SUPPLY PRESSURE AT INLET (PSI)				
	20	40	60	80	100
3/4"	8	12	15	17	20



OPTIONS AND ACCESSORIES

WRENCH-FLAT DESIGN

All cast metal Penberthy jet pumps from 1.27 to 7.62 cm (½" to 3") have a standard wrench-flat to allow ease of assembly. This design eliminates the need for a pipe wrench and minimizes damage to the body.

CERAMIC NOZZLE JET PUMPS

When processing solids or slurries, the inside of a jet nozzle can wear quickly. A ceramic lining minimizes wear in the nozzle. The body is cast stainless steel. This design allows replacement of either part.

FLUOROELASTOMER LINED JET PUMPS

When processing solids or slurries, the inside of a jet pump body or nozzle can erode quickly. A fluoroelastomeric lining significantly minimizes premature erosion, increasing the service life of these units.

TEFZEL™ LINED EDUCTORS

In erosive and corrosive applications, Tefzel™ lining provides a durable inside surface. It performs flawlessly, even when internal temperatures reach 149°C (300°F), extending the service life of jet pumps used in these processing conditions.

OTHER JET PUMP PRODUCTS

In addition to the standard line of jet pumps, we offer a variety of components and specialty products. These devices either complement existing jet pumps or are complete, stand-alone systems.

AUTOMATIC INJECTORS

These are boiler feed pumps designed to use the velocity and condensation of a jet of steam from the boiler to lift and force a stream of water into the same boiler. The unique design warms the water to feed the boiler without preheating. These models can also be used for injection of feedwater treatments.

SUBMERSIBLE AUTOMATIC SUMP DRAINER

These reliable units create a powerful pumping action using either liquid or saturated steam as the operating medium and require minimal upkeep. Since no electricity is required for their operation, these units are unaffected by power outages. Typical applications include sump evacuation, steam service/boiler room operations, general manufacturing installations, in-plant services and manufacturing processes.

Emerson also provides assistance to help with your pumping, mixing and heating applications.

For more information about any jet pump product or related accessory, contact Emerson direct or your sales representative.

ORDERING

To select and order your Penberthy jet pump, consult the technical datasheets available on our website or complete the online application form with the motive, suction and discharge specifications (measured at those respective ports) of your application. Then, contact your sales representative for assistance selecting the proper pump.

Tefzel™ is a trademark of The Chemours Company.

Kynar® is a registered trademark of Arkema Inc.



Emerson Electric Co.
Global Headquarters
8000 West Florissant Avenue
St. Louis, Missouri, 63136
United States
T +1 314 679 8984
ContactUs@Emerson.com
Emerson.com/FinalControl

**Final Control
North America**

Marshalltown
301 South 1st Avenue
Marshalltown, Iowa, 50158
United States
T +1 641 754 3011

McKinney
3200 Emerson Way
McKinney, Texas, 75070
United States
T +1 800 558 5853

Houston
19200 Northwest Freeway
Houston, Texas, 77065
United States
T +1 281 477 4100

Stafford
3950 Greenbriar Drive
Stafford, Texas, 77477
United States
T +1 281 274 4400

**Emerson Automation Solutions
World Area Headquarters**

Asia Pacific
1 Pandan Crescent
Singapore 128461
T +65 6777 8211

Europe
Neuhofstrasse 19a P.O. Box
1046 CH 6340 Baar,
Switzerland
T +41 41 768 6111

Latin America
1300 Concord Terrace Suite 400
Sunrise, Florida 33323,
United States
T +1 954 846 5030

Middle East & Africa

Emerson FZE P.O. Box 17033,
Jebel Ali Free Zone - South 2,
Dubai, United Arab Emirates
T +971 4 8118100

 Emerson.com

 Facebook.com/EmersonAutomationSolutions

 LinkedIn.com/company/Emerson-Automation-Solutions

 Twitter.com/EMR-Automation

©2017 Emerson Automation Solutions. All rights reserved.

Penberthy is a mark owned by one of the companies in the Emerson Automation Solutions business unit of Emerson Electric Co. The Emerson logo is a trade mark and service mark of Emerson Electric Co. All other marks are property of their respective owners.

The contents of this publication are presented for information purposes only, and while effort has been made to ensure their accuracy, they are not to be construed as warranties or guarantees, express or implied, regarding the products or services described herein or their use or applicability. All sales are governed by our terms and conditions, which are available on request. We reserve the right to modify or improve the designs or specifications of our products at any time without notice. Responsibility for proper selection, use and maintenance of any product or service remains solely with the purchaser and end user.

VCPBR-04546-EN 18/11



CONSIDER IT SOLVED™