

# Envelope Dimensions and Torque Data

## XL681 Double acting and Spring Return actuator

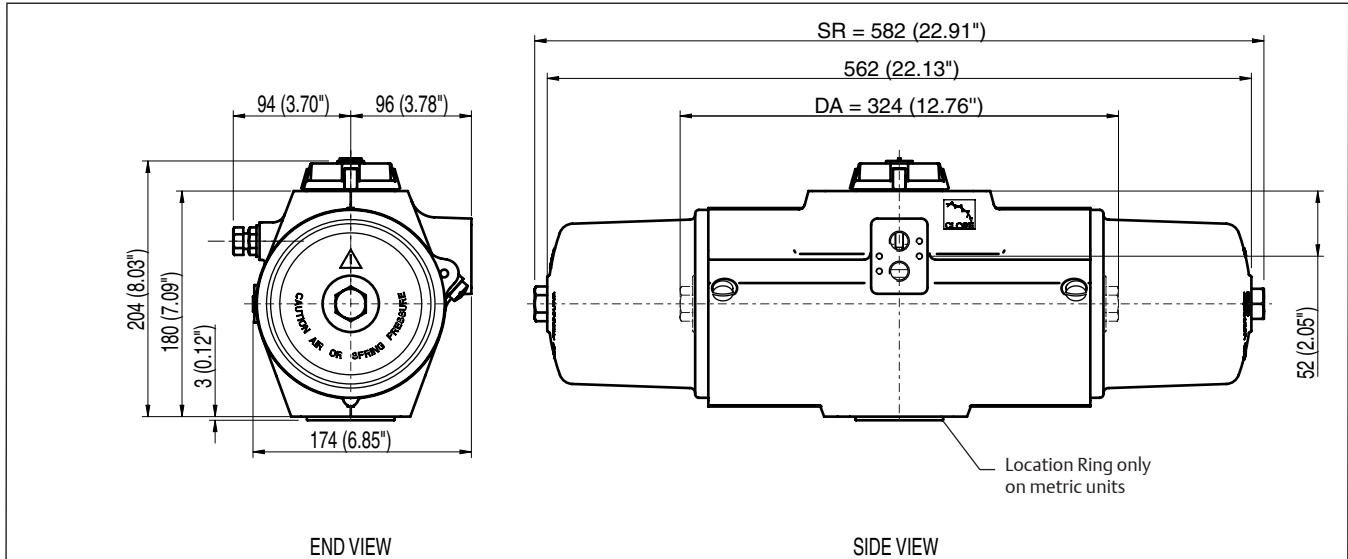

### Torque in Nm, Pressure in bar(g)

Double Acting Torques		259		345		431		474		517		604		690		
Spring Rating	Torque From Springs		3.0 bar(g)		4.0 bar(g)		5.0 bar(g)		5.5 bar(g)		6.0 bar(g)		7.0 bar(g)		8.0 bar(g)	
	Start	End	Start	End	Start	End	Start	End	Start	End	Start	End	Start	End	Start	End
S40	151	91	168	108	254	194	340	280	384	323	427	366	513	453	599	539
S50	189	113	145	70	232	156	318	242	361	285	404	329	490	415	576	501
S60	227	136	123	32	209	118	295	205	338	248	381	291	468	377	554	463
S70	264	159	-	-	186	81	273	167	316	210	359	253	445	339	531	425
S80	302	181	-	-	164	43	250	129	293	172	336	215	422	301	509	388
S90	340	204	-	-	-	-	227	91	270	134	313	178	400	264	486	350
S1C	378	227	-	-	-	-	205	54	248	97	291	140	377	226	463	312

### Torque in inch-pounds, Pressure in PSI

Double Acting Torques		2091		2613		3136		4181		4704		5226		6272		
Spring Rating	Torque From Springs		40 PSI		50 PSI		60 PSI		80 PSI		90 PSI		100 PSI		120 PSI	
	Start	End	Start	End	Start	End	Start	End	Start	End	Start	End	Start	End	Start	End
S40	1337	802	1289	754	1811	1277	2334	1799	3379	2844	3902	3367	4424	3890	5470	4935
S50	1671	1002	1088	420	1611	942	2133	1465	3179	2510	3701	3033	4224	3556	5269	4601
S60	2005	1203	-	-	1410	608	1933	1131	2978	2176	3501	2699	4023	3221	5069	4267
S70	2339	1403	-	-	-	-	1732	797	2778	1842	3300	2365	3823	2887	4868	3933
S80	2673	1604	-	-	-	-	1532	463	2577	1508	3100	2031	3622	2553	4668	3598
S90	3007	1804	-	-	-	-	-	-	2377	1174	2899	1696	3422	2219	4467	3264
S1C	3341	2005	-	-	-	-	-	-	2176	840	2699	1362	3221	1885	4267	2930