

Emerson NextGen Smart Firewall

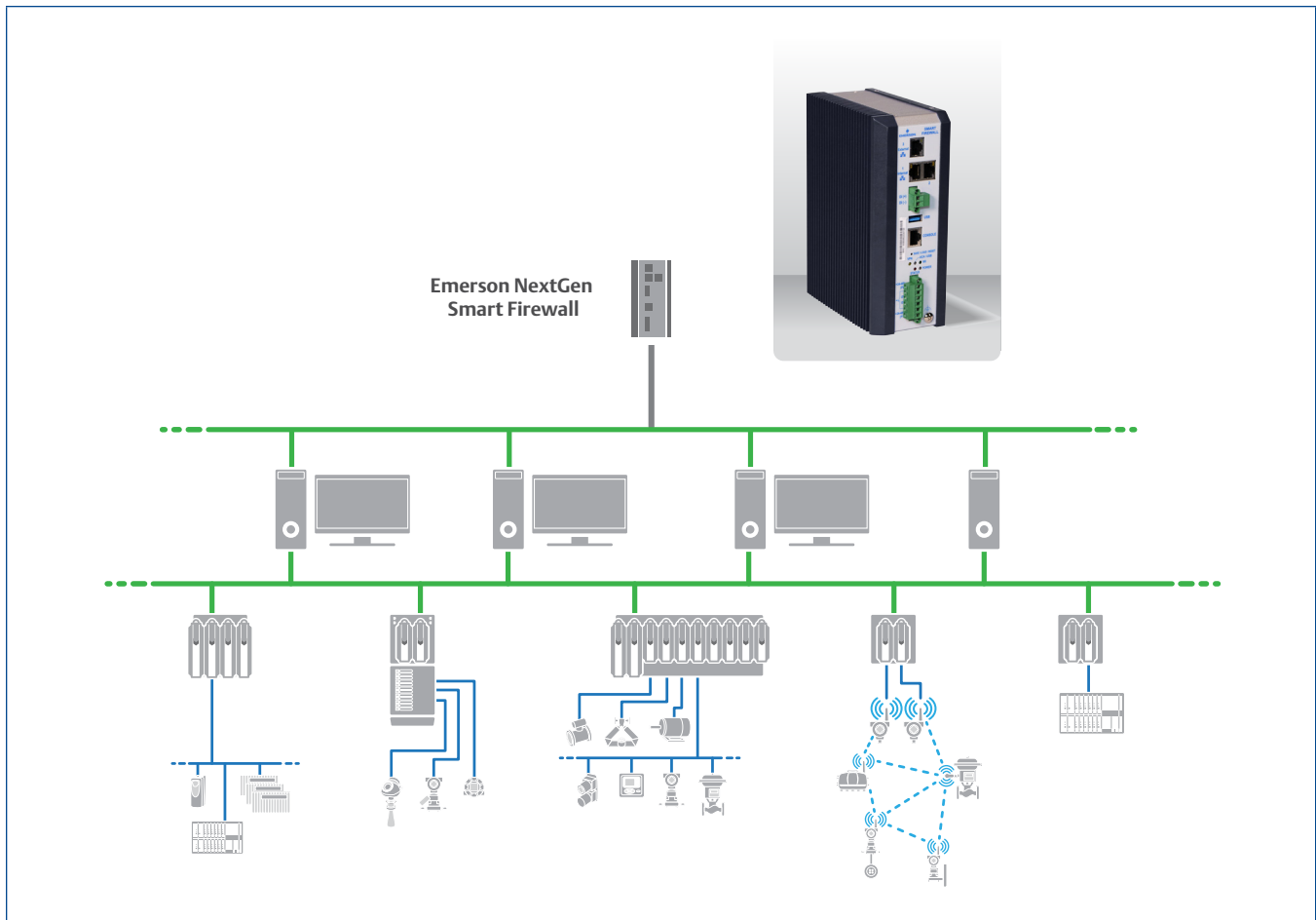

The Emerson NextGen Smart Firewall protects the DeltaV™ system with an easy-to-use perimeter defense solution.

- Purpose-built for easy deployment in the DeltaV™ system
- Easy-to-use HTML5 web based user interface
- “Firewall friendly” distributed component object model (DCOM) communications
- Monitor firewall hardware alerts on DeltaV operator workstations

Introduction

The Emerson NextGen Smart Firewall is a built-for-purpose perimeter firewall specifically designed to provide an easy to install and easy to maintain perimeter security solution for a Distributed Control System (DCS).

The Emerson NextGen Smart Firewall is a hardware-based perimeter protection solution designed to enforce highly controlled external network access to a DeltaV™ DCS. Even without security expertise, it is easy to configure to meet requirements for strongly enforced network segmentation.

The Emerson NextGen Smart Firewall is specifically designed for use with DeltaV systems. Its user-friendly interface provides simplicity through easy-to-understand setup menus. With pre-loaded DeltaV application rules, it is easy for a DeltaV administrator, or controls engineer, to create secure connections for DeltaV applications that communicate with computers outside the DeltaV network.

New Benefits of NextGen Firewall

Greater Bandwidth – The Emerson NextGen Smart Firewall offers the option of two models with either 10/100/1000 Mbps all copper Ethernet ports or a 1000 Mbps SFP Fiber external port and two 10/100/1000 Mbps copper Ethernet internal ports. Bandwidth supports improved performance for higher bandwidth applications e.g., backup and recovery
– *Faster communication.*

Ruggedized Construction – Convection-cooled high strength sheet metal non-condensing enclosure.
– *Built for OT.*

Traffic Shaping – Safeguard high performance of critical applications in limited bandwidth scenarios.
– *Prioritization / Quality of Service (QoS).*

User-friendly UI – Updated, user interface.
– *Simple and easy.*

More Granular User Roles – More user roles/permissions providing increased, yet intuitive, access control.
– *Enhanced role-based access controls (RBAC).*

Centralize User Management – Control firewall access by integrating up to 4 redundant Light Directory Access Protocol (LDAP) or 8 redundant Remote Authentication Dial-In User (RADIUS) authentication servers.
– *Access Control Management.*

Benefits Consistent with Previous Firewall

Purpose Built – The Emerson NextGen Smart Firewall is specifically designed for use in DeltaV network architecture. The user-friendly interface provides simplified and easy to understand setup menus.
– *Simple to install and maintain.*

Tailored to DeltaV Administrators – No Security or IT expertise is required to setup and maintain standard features of the firewall. Enabling DeltaV support personnel to manage the perimeter security of a DeltaV system.
– *No expertise for standard features.*

Extensive, out of the box DeltaV Application List – Over 80 pre-loaded application rules are provided with the Emerson NextGen Smart Firewall, covering connections typically used with DeltaV systems. The ability to add additional custom applications is supported.
– *Easy communications setup.*

Management Interface – The password protected, web-based user interface provides intuitive, menu-based navigation and easy-to-understand configuration selections.
– *Ease of management.*

Simplify DCOM Connectivity – Advanced capability makes the firewall DCOM “friendly.” Dynamic port mapping provides a more secure solution for communications.
– *Easier and more secure DCOM communications.*

Conform to new Security Standards – the Emerson NextGen Smart Firewall allows you to meet emerging security standards that require strong network perimeter protection with an economical and easy to implement solution.
– *Meet security standards.*

Hardware Description

The Emerson NextGen Smart Firewall is a DIN rail, or rack mountable, 20-48 V DC device. It is a fanless device with rugged convection cooled metal construction fit for industrial environments.



Emerson NextGen Smart Firewall all copper Ethernet (TX) model.

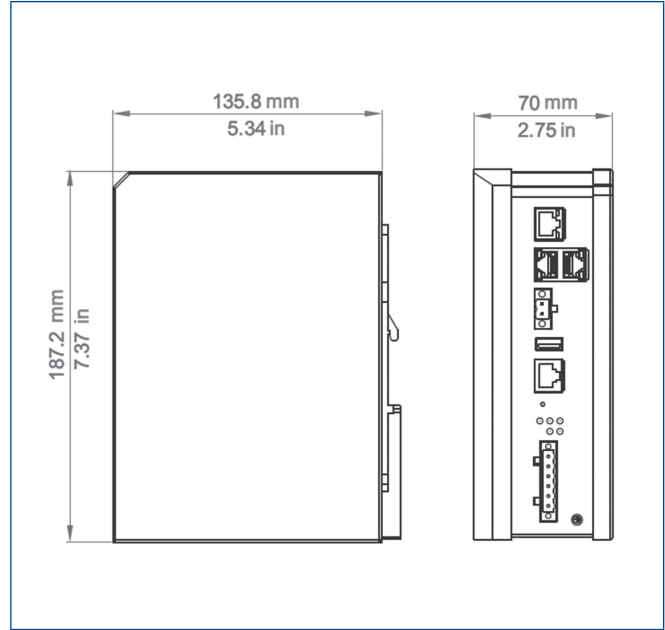

Emerson NextGen Smart Firewall dimensions.

Recovery Port – serial port to access Command Line Interface (CLI) for same role based configuration access as the WebUI.

External Local Area Network (LAN) Connection – network connection for external LAN.

DeltaV Connection – network connection to the L2.5 on the DeltaV workstations.

Status Indicator LEDs – provides visual indication of firewall status.

Power Inputs and Supplies: Bringing power from two different sources increases overall availability.

USB Drive: Stores configuration for quick firewall replacement if option is enabled by the user.

L2.5 and the DeltaV Security Zone

The Emerson NextGen Smart Firewall is specifically designed to be installed at the perimeter of the DeltaV system and help manage external communication connections between the plant LAN or DMZ (demilitarized zone) and DeltaV workstations. Locating the firewall between DeltaV workstations and external plant networks creates a network that needs to be treated as part of the DeltaV security zone.

This network is architecturally located between the level 2 control network and the level 3 external network and is referred to as the “L2.5.”

Installing the Emerson NextGen Smart Firewall effectively locates the boundary of the DeltaV system at the external output of the firewall. The firewall and the networks below the firewall should be treated as high security zones.

All communications allowed through the firewall should be tightly managed to permit only data flows and remote user access necessary to manage the system and export or import process information.

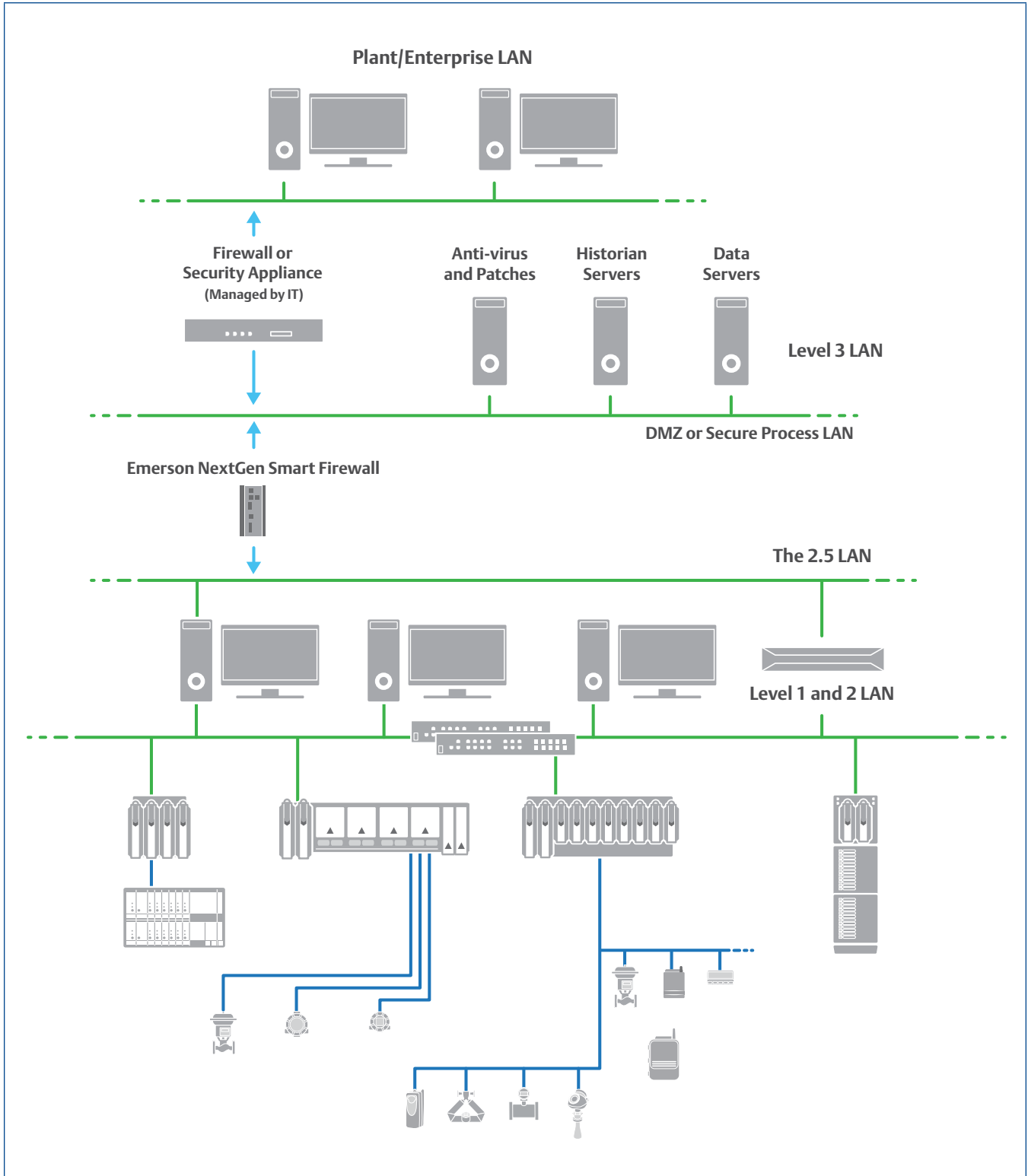

Ideally, each DeltaV system should have a dedicated Emerson NextGen Smart Firewall for ease of management and maintenance. L2.5 should only contain computers and devices that are dedicated to support the single DeltaV system connected to the DeltaV side of the firewall port. Computers that will be accessed by other DeltaV systems or other control systems should be in the DMZ.

Secure Configuration

The user interface of the Emerson NextGen Smart Firewall encourages a more secure environment where adding new connections or new external computers to the system require deliberate action by the firewall administrator. This prevents unauthorized users from easily gaining access to the DeltaV control system without the knowledge of the firewall administrator.

The Firewall Configuration Interface

The Emerson NextGen Smart Firewall is configured from a built-in web-based interface (WebUI) that can be accessed from any workstation on the DeltaV network with network access to the firewall. The WebUI is password-protected with granular access control that allows for four different levels of user access (and one deny-list).

Firewall User Roles

There are different levels of user access: Administrator, Engineer, Auditor and Guest. Administrator has access to all functions for viewing and configuring the firewall configuration.

Engineer can configure some features (enable/disable protection rules) but cannot manage other users.

Creating new firewall users and assigning one of the preset roles is easy.

Emerson NextGen Smart Firewall Setup and Management

The Emerson NextGen Smart Firewall management interface has several sections that group similar functionality.

Access to the information in the tabs is user access controlled, so changes to the firewall settings can be assigned based on user roles.

Easy-to-Configure Communications Access

The “smart” part of the Emerson NextGen Smart Firewall lies in the pre-loaded list of DeltaV application rules increasing configuration simplicity.

The list includes application rule information for all the standard DeltaV applications that are designed to communicate with applications located on the L3/DMZ Network computers or above.

The UI shows all communication paths through the firewall that are currently being used.

Pre-loaded application rules are part of the configuration and can be managed by the user to delete rules that would never be used in a specific system, to reduce the size of the list and, to configure custom rules.

Applications can also be disabled or deleted so that they do not appear in the application list when creating authorized communications. This allows the administrator to delegate the ability to create a very limited set of communications to a user assigned the “engineer” access role.

Rules can be renamed to fit the context of a specific site’s nomenclature.

Customer-specific (custom) rules can easily be created and added to the list to support non-DeltaV applications that will communicate through the firewall.

It is also easy to add new DeltaV applications to the list when upgrading your system.

<input type="checkbox"/>	Index	<input type="checkbox"/> Application Rule name	<input type="checkbox"/> Protocol	<input type="checkbox"/> Port	<input type="checkbox"/> Direction	<input type="checkbox"/>
<input type="checkbox"/>	1	Acronis: Backup/Restore Utility, data transfer	tcp	9876,25001	outbound	<input type="checkbox"/>
<input type="checkbox"/>	2	Acronis: Backup/Restore Utility, mgmt console access	tcp	9876,25001	outbound	<input type="checkbox"/>
<input type="checkbox"/>	3	AMS Device Manager Distributed System T	tcp	7,80,135,1433,6660,77	both	<input type="checkbox"/>

DeltaV Application rules are pre-loaded.

Emerson NextGen Smart Firewall Features and Capabilities



Hardware Specifications		
Dimensions	7.37 in. high x 5.34 in. wide x 2.75 in. deep	
Weight	69.13 oz (1960 g)	
Power Supply	2 voltage inputs for redundant power supply	
	Safety extra-low voltage (SELV), redundant inputs disconnected	
	Nominal Voltage DC = 24V DC ... 48 V DC	
	Voltage Range DC = 20 V DC ... 58 V DC	
	Connection Type – 6-pin terminal block	
	Input Terminal Block	24 AWG (0.2 mm ² ... 18 AWG (0.75 mm ²) One individual conductor in a clamping point
	Grounding Conductor – at least 18 AWG (0.75 mm ²)	
Signal Contact	Connection Type – 6 – pin terminal block	
	Tightening Torque – 7 lb-in (0.79 N-m)	
	Nominal Value – (I _{max} = 0.5 A at U _{max} = 24 V DC), (I _{max} = 0.5 A at U _{max} = 48 V DC)	
Digital Input	Connection Type	2-pin terminal block
		Tightening torque – 7 lb-in (0.79 N-m)
		24 AWG (0.2 mm ² ... 18 AWG (0.75 mm ²)
	Maximum permitted input voltage range = -32 V DC ... +32 V DC	
	Nominal input voltage = 24 V DC	
	Input voltage, low level, status “0” = -0.3 V DC ... +5.0 V DC	
	Input voltage, high level, status “1” = +11 V DC ... +30 V DC	
	Maximum input current at 24 V input voltage = 15 mA	
	Input characteristic acc. to IEC 61131-2 (current-consuming)	Type 3
Power Consumption/Power Output	Max Power Consumption = 15 W	
	Power Output = 51 Btu (IT)/h	
Mounting	Supports rackmount kit, DIN Rail kit or wall mounting	
Environmental	Ambient air temperature * – (-40°F ... +158°F) or (-40°C ... +70°C) Storage/transport temperature – (-40°F ... +185°F) or (-40°C ... +85°C) Relative humidity (non-condensing) – (10% ... 95%)	
Certifications	FCC, UL, CE, UKCA RoHS, China RoHS, RCM, EAC	

*For the Rackmount Kit, the power supplies are rated at a max operating temperature of 55°C.

Specifications – Emerson NextGen Smart Firewall	
Compatibility with DeltaV versions	
<p>The Emerson NextGen Smart Firewall is compatible with all versions of DeltaV¹.</p> <p>Custom communications rules can be created to allow the firewall to be used with virtually any system or application².</p> <p>1. The ports and protocol parameters used in the DeltaV system and complementary products available in the Application List have been tested with all supported versions of DeltaV. These parameters should also be valid for older versions of the applications. However, it is possible that there are differences in the older application versions that are not reflected in the current Application List. If differences are encountered, the Application List is user configurable to allow the correct parameters to be changed and/or entered manually into the list. Custom applications can also be created and added to the Application List.</p> <p>2. Use of the firewall is not limited to the protection of just DeltaV systems, but it can be used to protect many different systems. The Application List specific to Emerson communications can be removed and lists specific to the applications easily created.</p>	
Capacities	
Max Throughput	Up to 1 Gbps (1000 Mbps)
Max VPN Sessions	64 max VPN Tunnels possible
Max Concurrent VPN Connections	16 max active sessions



Specifications – Emerson NextGen Smart Firewall	
Firewall Users	<p>Supported user types:</p> <ul style="list-style-type: none"> ■ Administrator – full access ■ Engineer – limited configuration access ■ Auditor – device monitoring and saving logs ■ Guest – device monitoring only ■ Unauthorized – blocked access (deny-list)
Interface	
Configuration	Firewall configuration is supported using the built-in HTML5 browser-based interface.
Ports	<p>Two models:</p> <ul style="list-style-type: none"> ■ VE6206TX - 2x 10/100/1000 Mbps Copper Ethernet Internal-Ports and 1x 10/100/1000 Mbps Copper Ethernet External-Port ■ VE6206SFP - 2x 10/100/1000 Mbps Copper Ethernet Internal-Ports and 1x 1000 Mbps SFP Fiber External-Port
USB 3.0	1x USB 3.0 port to be used for backups, recovery, and firmware upgrades. USB is not included
Serial/Console	V.24 console port for local management with command line capability. Serial cable not included.
Status LEDs	LEDs on front panel for supply voltage indication, device status, fiber connection (where applicable), USB storage medium presence and status, VPN (if enabled using advanced menus) and for future use.
Power	6-pin terminal block with uncoupled inputs with no distributed load.

Emerson NextGen Smart Firewall Network Security Features	
Stateful Firewall	
Supported Firewall Modes	Routed Mode, Transparent Mode, NAT
Security	DoS Prevention, IPSec VPN, OPC Enforcer, Modbus TCP Enforcer
Dynamic Host Configuration Protocol (DHCP) Server	Provides network (IP) addresses to devices on the DeltaV side of the firewall. DHCP can be disabled to allow static addressing of DeltaV workstations.
DHCP Client	External firewall port can obtain network (IP) address from external DHCP server or use a static address. (DHCP client disabled by default. DHCP client for external port ideal with a reserved IP address from external DHCP server. Alternatively, static addressing can be used to avoid DHCP readdressing the firewall external port).
Infrastructure	
DeltaV NDCC Integration and Monitoring	SNMPv3 access can be enabled to monitor firewall parameters. Network Device Command Center (NDCC) can be used to monitor Emerson NextGen Smart Firewall hardware alarms on DeltaV v13.3.2 and later.
Syslog Support	The firewall can send all logs to a Syslog server (e.g., Kiwi Syslog) if enabled and the server address configured.
Network Time Protocol (NTP) Support	The firewall can have time set locally, get time from connected computer, or through an NTP Server.

Ordering Information	
Emerson NextGen Smart Firewall - Copper Internal Ports, Copper External L2.5 Port	VE6206TX
Emerson NextGen Smart Firewall - Copper Internal Ports, SFP Fiber External L2.5 Port. A Fiber Optic SFP Transceiver is required (and not included).	VE6206SFP
DeltaV Bulk Power Supply 100-240 V AC to 24 V DC, 5A. This option is available if you want to order the power supply component as a standalone. Otherwise, for the complete “KIT”, reference VE6206XX-KIT part numbers below.	VE5138 
Rackmount Adapter for use with Emerson NextGen Smart Firewall. This option is available if you want to order the power supply component as a standalone. Otherwise, for the complete “KIT”, reference VE6206XX-KIT part numbers below.	VE6206RM 

Rackmount Kit

The Emerson NextGen Smart Firewall is available in a 2U, 19inch x 8.5inch Rackmount Kit that consists of: one firewall, two 24V DC power supplies, and a 2U rack mount.





Description	Model Number
<p>Rackmount Kit: Emerson NextGen Smart Firewall, Copper Ethernet Ports; Two 24 V DC Power Supplies*, and 1 Rackmount Adapter. Does not include power cabling. *Power supplies max operating temperature 55°C</p>	<p>VE6206TX-KIT</p> 
<p>Rackmount Kit: Emerson NextGen Smart Firewall, SFP and Copper Ethernet Ports; Two 24V DC Power Supplies*, and 1 Rackmount Adapter. Does not include power cabling. A Fiber Optic SFP Transceiver is required (and not included). *Power supplies max operating temperature 55°C</p>	<p>VE6206SFP-KIT</p> 

Fiber Optic SFP Transceivers for use in Emerson NextGen Smart Firewall

The Gigabit transceivers can be used only in the gigabit WAN port of the VE6026SFP model.

The transceiver VE6050T011 cannot be used when certain certifications are required such as: KCC.

Note: the Emerson NextGen Smart Firewall must use the transceiver modules indicated below. It is not compatible with other brands of transceiver modules.

Description	Model Number
<p>Transceiver for Emerson NextGen Smart Firewall: 1 Gigabit Ethernet; Single Mode Long Haul, for up to 120 Kilometers of fiber-optic cable (M-SFP-LH+/LC).</p>	<p>VE6050T01 <i>Gigabit</i></p> 
<p>Transceiver for Emerson NextGen Smart Firewall: 1 Gigabit Ethernet; Single Mode Long Haul, for up to 80 Kilometers of fiber-optic cable (M-SFP-LH/LC-EEC).</p>	<p>VE6050T02 <i>Gigabit</i></p> 
<p>Transceiver for Emerson NextGen Smart Firewall: 1 Gigabit Ethernet; Single Mode, for up to 20 Kilometers of fiber-optic cable (M-SFP-LX/LC EEC).</p>	<p>VE6050T03</p> 
<p>Transceiver for Emerson NextGen Smart Firewall: 1 Gigabit Ethernet; Multi-mode, for up to 550 meters of fiber-optic cable (M-SFP-SX/LC EEC).</p>	<p>VE6050T07</p> 
<p>Transceiver for Emerson NextGen Smart Firewall: 1 Gigabit Ethernet; Single Mode, for up to 20 Kilometers of fiber-optic cable (SFP-GIG-LX/LC EEC).</p>	<p>VE6050T011</p> 

Related Products

DeltaV Smart Switches – the DeltaV Smart Switch and the DeltaV Network Device Command Center (NDCC) are also part of DeltaV family of built-for-purpose security related products.

Prerequisites

To implement the Emerson NextGen Smart Firewall, it is helpful to have basic knowledge of Ethernet networking including network addressing and routing.

©2024, Emerson. All rights reserved.

The Emerson logo is a trademark and service mark of Emerson Electric Co. The DeltaV logo is a mark of one of the Emerson family of companies. All other marks are the property of their respective owners.

The contents of this publication are presented for informational purposes only, and while diligent efforts were made to ensure their accuracy, they are not to be construed as warranties or guarantees, express or implied, regarding the products or services described herein or their use or applicability. All sales are governed by our terms and conditions, which are available on request. We reserve the right to modify or improve the designs or specifications of our products at any time without notice.

Contact Us

 www.emerson.com/contactus