

Permanently installed ultrasonic flowmeter for liquids

Features

- 4 measuring channels to compensate highly disturbed flow profiles and to facilitate more accurate and repeatable measurements
- Best suitable for applications with limited straight runs
- High precision at fast and slow flow rates, high temperature and zero point stability

Applications

- Monitoring for large water transport lines
- Surveillance of hydro power penstocks
- Redundant check metering to custody transfer flow measurements
- Allocation flow measurement in transport systems



FLEXIM AMERICAS Corporation
Edgewood, NY 11717
USA

Tel.:(631) 492-2300
Fax:(631) 492-2117

internet: www.flexim.com
e-mail: usinfo@flexim.com

1-888-852-7473



TSFLUXUS_F736V1-1US_Lus, 2023-10-01

Subject to change without prior notice.
Errors excepted.
FLUXUS is a registered trademark of FLEXIM GmbH.

Copyright (©) FLEXIM GmbH 2023

Transmitter

Technical data

	FLUXUS F736**-NN	FLUXUS F736**-A2	FLUXUS F736**-F2
			
design	field device with 4 measuring channels in stainless steel housing		
measurement			
measurement principle	transit time difference correlation principle, automatic NoiseTrek selection for measurements with high gaseous or solid content		
flow direction	bidirectional		
synchronized channel averaging	x		
flow velocity	ft/s	measuring range: 0.03 to 82	
repeatability		0.15 % MV ±0.02 ft/s	
fluid	all acoustically conductive liquids with < 10 % gaseous or solid content in volume (transit time difference principle)		
temperature compensation	corresponding to the recommendations in ANSI/ASME MFC-5.1-2011		
measurement uncertainty (volumetric flow rate)			
measurement uncertainty of the measuring system ¹	±0.3 % MV ±0.02 ft/s includes calibration certificate traceable to NIST		
measurement uncertainty at the measuring point ²	±1 % MV ±0.02 ft/s		
transmitter			
power supply		<ul style="list-style-type: none"> • 90 to 250 V/50 to 60 Hz or • 11 to 32 V DC 	
power consumption	W	< 15	
number of measuring channels		4 (1 measuring point)	
damping	s	0 to 100 (adjustable)	
measuring cycle	Hz	100 to 1000	
response time	s	1	
housing material		stainless steel 316L	
degree of protection		IP66	
dimensions	inch	see dimensional drawing	
weight	lb	15.9	
fixation		wall mounting, optional: 2" pipe mounting	
ambient temperature	°F	-40 to +140 (< -4 without operation of the display)	-4 to +131
display		128 x 64 pixels, backlight	
menu language		English, German, French, Spanish, Dutch, Russian, Polish, Turkish, Italian, Chinese	
explosion protection			
• ATEX			
marking	-	CE  II 3G Ex nA ic IIC T4 Gc T _a -40...+60 °C	-
• FM			
marking	-	-	 NI/CI: I, II, III / Div. 2 / GP: A, B, C, D, E, F, G / T5 -20 °C ≤ T _a ≤ 55 °C IP64
certification	-	-	FM23US0080, FM23CA0059
measuring functions			
physical quantities		volumetric flow rate, mass flow rate, flow velocity, thermal energy rate (if temperature inputs are installed)	
totalizer		volume, mass, optional: thermal energy	
diagnostic functions		sound speed, signal amplitude, SNR, SCNR, standard deviation of amplitudes and transit times	
communication interfaces			
service interfaces		measured value transmission, parametrization of the transmitter: <ul style="list-style-type: none"> • USB³ • LAN³ 	
process interfaces		max. 1 option: <ul style="list-style-type: none"> • Modbus RTU • BACnet MS/TP • HART • Modbus TCP • BACnet IP • Profibus PA • FF H1 	max. 1 option: <ul style="list-style-type: none"> • Modbus RTU • BACnet MS/TP • HART • Profibus PA • FF H1

¹ with aperture calibration of the transducers

² for transit time difference principle and reference conditions

³ outside the explosive atmosphere (housing cover open)

	FLUXUS F736**-NN	FLUXUS F736**-A2	FLUXUS F736**-F2
accessories			
data transmission kit	USB cable		
software	<ul style="list-style-type: none"> FluxDiagReader: reading of measured values and parameters, graphical representation FluxDiag (optional): reading of measurement data, graphical representation, report generation, parametrization of the transmitter 		
data logger			
loggable values	all physical quantities, totalized physical quantities and diagnostic values		
capacity	max. 800 000 measured values		
outputs			
	The outputs are galvanically isolated from the transmitter.		
number	active current inputs and outputs: max. 4		
• switchable current output			
	configurable according to NAMUR NE43 All switchable current outputs are jointly switched to active or passive.		
number	max. 4		
range	mA	4 to 20 (alarm current: 3.2 to 3.99, 20.01 to 24, hardware fault current: 3.2)	
uncertainty	0.04 % of output value $\pm 3 \mu\text{A}$		
active output	$R_{\text{ext}} = 250 \text{ to } 530 \Omega$, $U_{\text{opencircuit}} = 28 \text{ V DC}$		
passive output	$U_{\text{ext}} = 9 \text{ to } 30 \text{ V DC}$, depending on R_{ext} ($R_{\text{ext}} < 458 \Omega$ at 20 V)		
current output in HART mode	option		
• range	mA	4 to 20 (alarm current: 3.5 to 3.99, 20.01 to 22, hardware fault current: 3.2)	
• active output	$R_{\text{ext}} = 250 \text{ to } 530 \Omega$, $U_{\text{opencircuit}} = 28 \text{ V DC}$		
• passive output	$U_{\text{ext}} = 9 \text{ to } 30 \text{ V DC}$, depending on R_{ext} ($R_{\text{ext}} = 250 \text{ to } 458 \Omega$ at 20 V)		
• digital output			
number	max. 4		
functions	<ul style="list-style-type: none"> frequency output binary output pulse output 		
type	open collector (passive)		
operating parameters	8.2 V/30 mA (NAMUR)		
max. values	8 mA at 29 V DC		
frequency output			
• range	kHz	2 to 10	
• damping	s	0 to 999.9	
• pulse-to-pause ratio	1:1		
binary output			
• binary output as alarm output	limit, change of flow direction or error		
pulse output			
• pulse value	units	0.01 to 1000	
• pulse width	ms	0.05 to 1000	
• pulse rate	max. 10 000 pulses		
inputs			
	The inputs are galvanically isolated from the transmitter.		
number	active current inputs and outputs: max. 4		
• temperature input			
number	max. 4		
type	Pt100/Pt1000		
connection	4-wire		
range	°F	-238 to +1040	
resolution	K	0.01	
accuracy	$\pm 0.01 \text{ \% MV} \pm 0.03 \text{ K}$ at 64 to 82 °F $\pm 0.01 \text{ \% MV} \pm 0.03 \text{ K} \pm 0.0005 \text{ \% / K}$ at <64 °F/>82 °F		
cable resistance	Ω	max. 1000	
• switchable current input			
	All switchable current inputs are jointly switched to active or passive.		
number	max. 4		
accuracy	$\pm 0.1 \text{ \% MV} \pm 0.01 \text{ mA}$ at 64 to 82 °F $\pm 0.1 \text{ \% MV} \pm 0.01 \text{ mA} \pm 0.005 \text{ \% / K}$ at <64 °F/>82 °F		
resolution	μA	0.1	
active input	$R_{\text{int}} = 75 \Omega$, $I_{\text{max}} \leq 30 \text{ mA}$ $U_{\text{opencircuit}} = 28 \text{ V}$ (open circuit) $U_{\text{min}} = 21.4 \text{ V}$ at 20 mA		
• range	mA	0 to 20	
passive input	$U_{\text{ext}} = 24 \text{ V}$, $R_{\text{int}} = 35 \Omega$, $I_{\text{max}} \leq 24 \text{ mA}$		
• range	mA	0 to 20	

¹ with aperture calibration of the transducers

² for transit time difference principle and reference conditions

³ outside the explosive atmosphere (housing cover open)

Dimensions

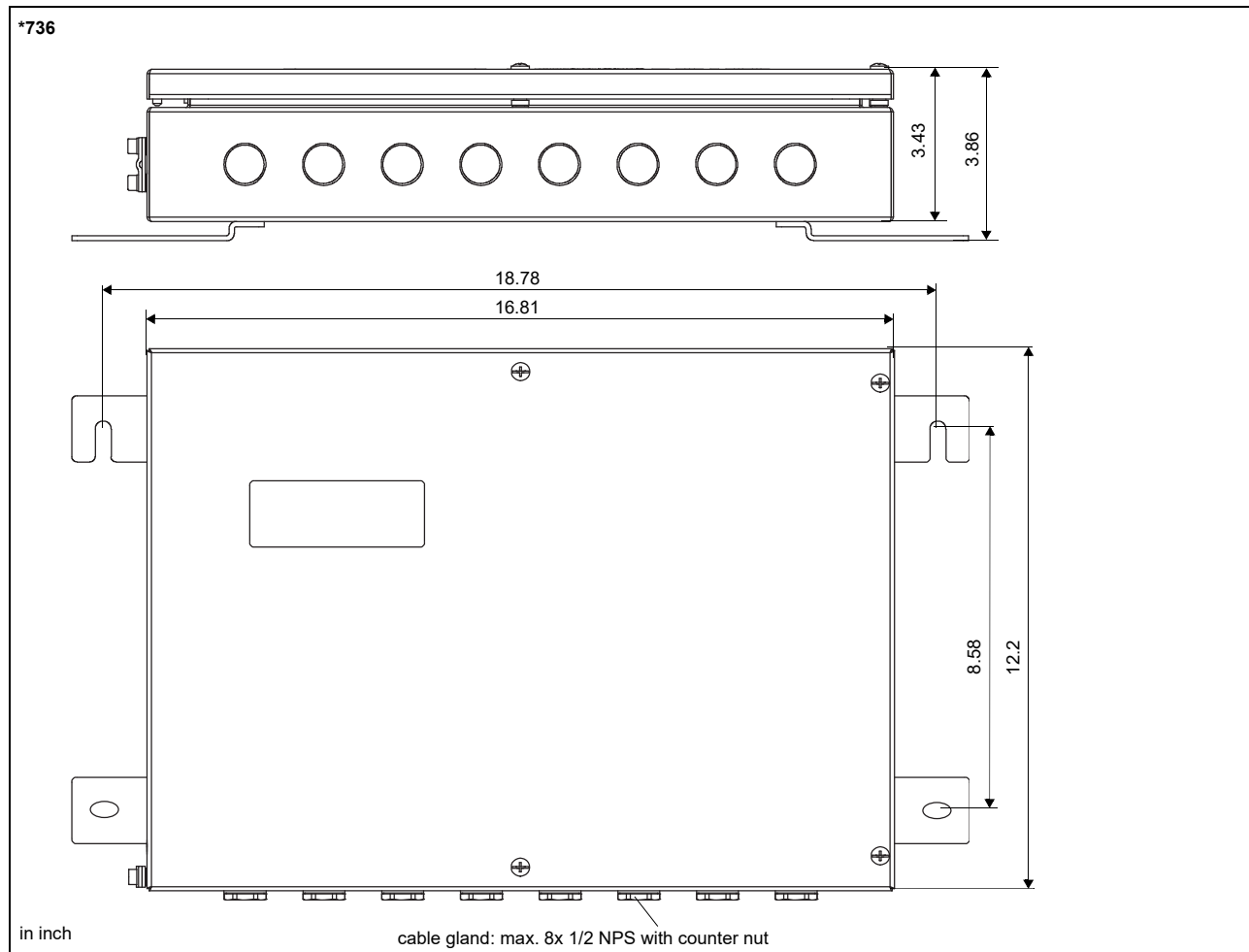

Wall and 2" pipe mounting kit

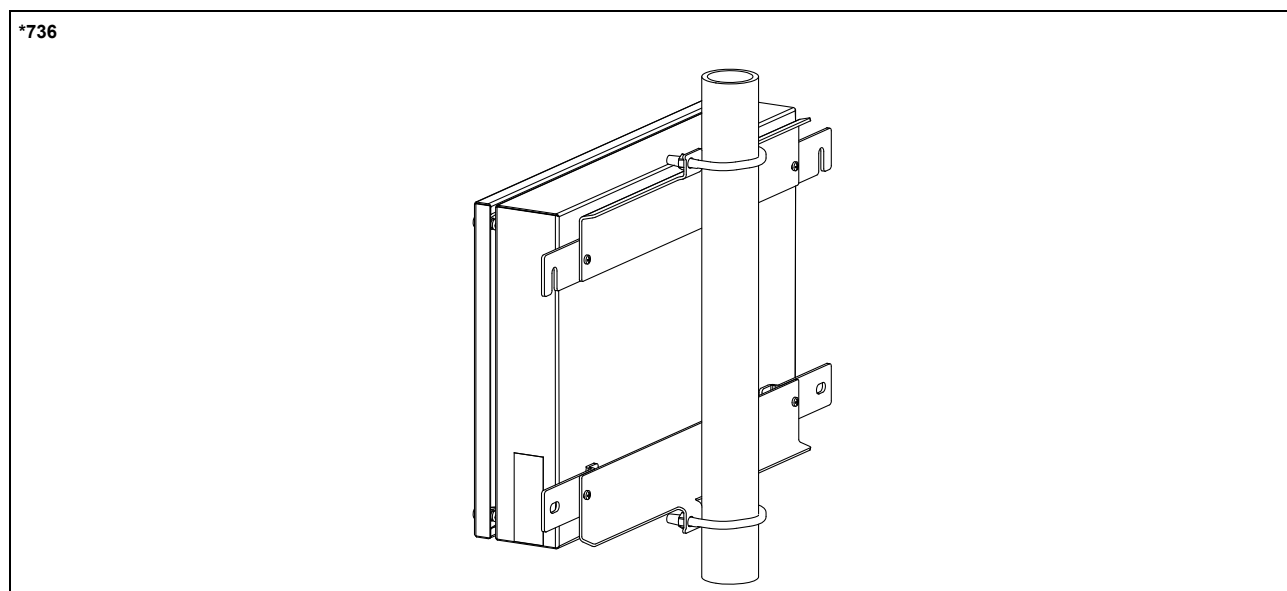

Storage

- do not store outdoors
- store within the original package
- store in a dry and dust-free place
- protect against sunlight
- keep all openings closed
- storing temperature: -4...+140 °F

Terminal assignment

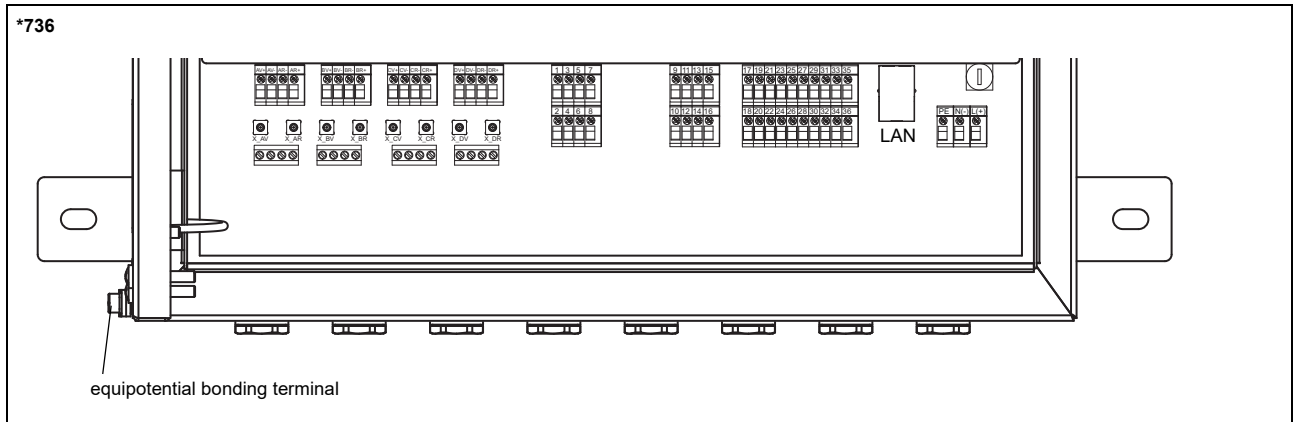

power supply ¹			
AC		DC	
terminal	connection	terminal	connection
L	outer conductor	(+)	+
N	neutral conductor	(-)	-
	protective conductor		protective conductor

¹ cable (by customer): e.g., flexible wires, with insulated wire ferrules, wire cross-section: AWG14 to 24

transducers, extension cable				
measuring channel A		measuring channel B		transducer
terminal	connection	terminal	connection	
AV	signal	BV	signal	↑
AVS	internal shield	BVS	internal shield	
ARS	internal shield	BRS	internal shield	⌞
AR	signal	BR	signal	

outputs, inputs ^{1, 2}	
terminal	connection
depending on configuration	current output, digital output, current input
1, 2, 3, 4 5, 6, 7, 8 9, 10, 11, 12 13, 14, 15, 16	temperature input
33+, 34-	passive current output/HART
33-, 34+	active current output/HART
33, 34	Modbus RTU, BACnet MS/TP, Profibus PA, FF H1

temperature probe		
terminal	direct connection	connection with extension cable, inline temperature probe
1, 5, 9, 13	red	white
2, 6, 10, 14	white	red
3, 7, 11, 15	red	black
4, 8, 12, 16	white	green

USB	type C Hi-Speed USB 2.0 Device	service (FluxDiag/FluxDiagReader)
LAN	RJ45 10/100 Mbps Ethernet	<ul style="list-style-type: none"> • service (FluxDiag/FluxDiagReader) • Modbus TCP • BACnet IP

¹ cable (by customer): e.g., flexible wires, with insulated wire ferrules, wire cross-section: AWG14 to 24

² The number, type and terminal assignment are customized.

Transducers



Overview

Shear wave transducers

	technical type						
	G	K	M	P	Q	S	
zone 2 - FM Class I Div. 2 - nonEx normal temperature range	CDG1N52 CLG1N52	CDK1N52 CLK1N52	CDM2N52 CLM2N52	CDP2N52 CLP2N52	CDQ2N52 CLQ2N52	CDS2N52	
zone 2 - nonEx IP68	CDG1L18	CDK1L18	CDM2L18	CDP2L18			
zone 2 - FM Class I Div. 2 - nonEx extended temperature range	CDG1E52 CLG1E52	CDK1E52 CLK1E52	CDM2E52 CLM2E52	CDP2E52 CLP2E52	CDQ2E52 CLQ2E52		
zone 1 normal temperature range	CDG1N81 CLG1N81	CDK1N81 CLK1N81	CDM2N81 CLM2N81	CDP2N81 CLP2N81	CDQ2N81 CLQ2N81		
zone 1 IP68	CDG1L11	CDK1L11	CDM2L11	CDP2L11			
zone 1 extended temperature range	CDG1E83 CLG1E83	CDK1E83 CLK1E83	CDM2E85 CLM2E85	CDP2E85 CLP2E85	CDQ2E85 CLQ2E85		
inner pipe diameter d							
min. extended	inch	15.7	3.9	2	0.98	0.39	0.24
min. recommended	inch	19.7	7.9	3.9	2	0.98	0.39
max. recommended	inch	157.5	78.7	39.4	15.7	5.9	2.8
max. extended	inch	255.9	94.5	47.2	18.9	9.4	2.8
pipe wall thickness							
min.	inch	0.43	0.2	0.1	0.05	0.02	0.01

for further data see Technical specification TS_F7xx-transducersVx-xxx_Lus

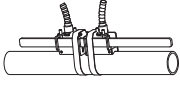
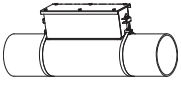
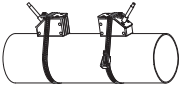
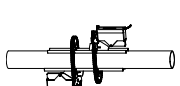
Transducer mounting fixture

PermaRail		PermaLok PL		quick release clasps and tension straps	WaveInjector with chains
	 transducer frequency S		 transducer frequency M, P	 transducer frequency M, P, Q	
					WaveInjector with threaded rods
					 outer pipe diameter: 1.4 to 15 inch

for further data see Technical specification TS_F7xx-transducersVx-xxx_Lus

Coupling materials for transducers

	normal temperature range		extended temperature range			WaveInjector	
	< 212 °F	< 338 °F	< 302 °F	< 392 °F	392 to 464 °F	< 536 °F	536 to 1166 °F
< 24 h	coupling compound type N or coupling pad type VT	coupling compound type E or coupling pad type VT	coupling compound type E or coupling pad type VT	coupling compound type E or H or coupling pad type VT	coupling pad type TF	coupling pad type A and coupling pad type VT	coupling pad type B and coupling pad type VT
long time measurement	coupling pad type VT	coupling pad type VT	coupling pad type VT	coupling pad type VT			

for further data see Technical specification TS_F7xx-transducersVx-xxx_Lus

Connection systems

connection system TS		
connection with extension cable	direct connection	transducers technical type
<p>JB02, JB03, JB04</p>		****52
connection system T1		
connection with extension cable	direct connection	transducers technical type
<p>JB01</p>		****8*
<p>JB01, JBP2, JBP3</p>		****L*

for further data see Technical specification TS_F7xx-transducersVx-xxx_Lus

Temperature probes

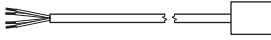
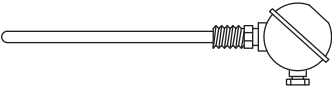
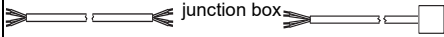
PT13N	PT13F	A2179
<ul style="list-style-type: none"> • Pt1000 • clamp-on • -40 to +392 °F 	<ul style="list-style-type: none"> • Pt1000 • clamp-on • response time: 8 s • -49 to +482 °F 	<ul style="list-style-type: none"> • Pt1000 • inline • -58 to +500 °F
<p>direct connection</p> 		
<p>connection with extension cable</p> <p>extension cable</p> 		

Annex

Reference conditions

as available at e.g. the test facilities of Physikalisch-Technische Bundesanstalt

measurement principle		transit time difference correlation principle
all uncertainties	%	95
fluid temperature		77 °F ±9 °F
ambient temperature		77 °F ±9 °F
warm-up time	min	10
flow profile at the measuring point		fully developed, rotationally symmetric
installation		installation according to specifications using the recommended transducers
Reynolds number		> 10 000
pipe diameter uncertainty	%	0.2
pipe wall thickness uncertainty	%	1
circularity tolerance		0.08 % of inner pipe diameter
SCNR	dB	> 48
SNR	dB	> 12