

Rosemount™ 2088, 2090P, and 2090F Pressure Transmitters

with 4–20 mA HART® and 1–5 Vdc HART
Low Power Protocol



Contents

Mount the transmitter.....	3	Safety instrumented systems.....	16
Set the jumpers.....	7	Product Certifications.....	19
Connect the wiring and power.....	9	Rosemount 2088 and 2090 Declaration of Conformity.....	40
Verify configuration.....	12		
Trim the transmitter.....	14		

1 Mount the transmitter

1.1 Rosemount™ 2088

Mount directly to the impulse line without using an additional mounting bracket or mount directly to a wall, panel, or two-inch pipe using an optional mounting bracket.

1.2 Rosemount™ 2090P

Mount directly to the process pipe using an existing weld spud, or have a skilled welder install a new weld spud using a TIG welder. Refer to [Reference Manual](#) for complete welding instructions. Improper installation may result in weld spud distortion. Recommended mounting in upright or horizontal position to allow proper draining of vent.

1.3 Rosemount™ 2090F

Mount directly to the process pipe using a standard sanitary fitting (either a 1.5- or 2-in. Tri Clamp connection). Recommended mounting in upright or horizontal position to allow proper draining of vent.

Figure 1-1: Transmitter Direct Mounting

Do not apply torque directly to the electronics housing. To avoid damage, apply torque only to the hex-shaped process connection.

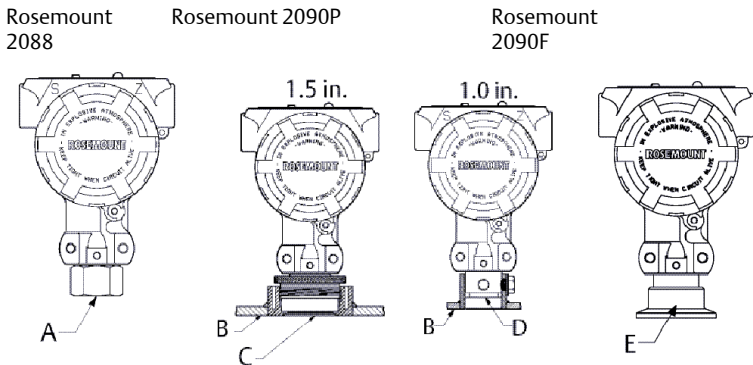

- A. $\frac{1}{2}$ -14 NPT female process connection
 - B. Vessel wall
 - C. Weld spud
 - D. O-ring
 - E. $1\frac{1}{2}$ - or 2-in. Tri Clamp connection
-

Figure 1-2: Panel and Pipe Mounting

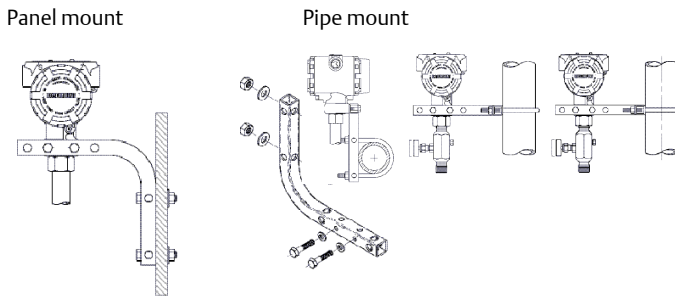

1.4 Liquid flow applications

Transmitter mounting procedure for liquid flow applications.

Procedure

1. Place taps to the side of the line.
2. Mount beside or below the taps.

Example

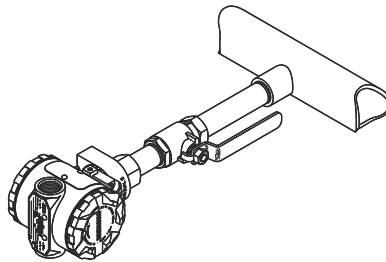

1.5 Gas flow applications

Transmitter mounting procedure for gas flow applications.

Procedure

1. Place taps in the top or side of the line.
2. Mount level or above the taps.

Example

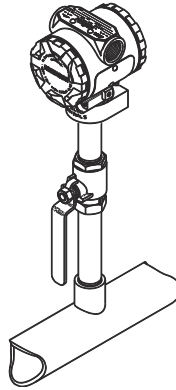

1.6 Steam flow applications

Transmitter mounting procedure for steam flow applications.

Procedure

1. Place taps to the side of the line.
2. Mount beside or below the taps.
3. Fill impulse lines with water.

Example

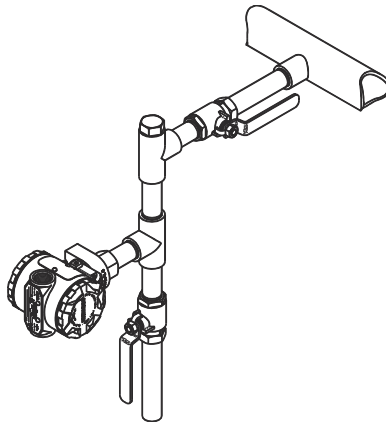

1.7 Environmental seal for housing

Thread sealing (PTFE) tape or paste on male threads of conduit is required to provide a water/dust tight conduit seal and meets requirements of NEMA® Type 4X, IP66, and IP68. Consult factory if other Ingress Protection ratings are required. For M20 threads, install conduit plugs to full thread engagement or until mechanical resistance is met.

1.8 Gage transmitter orientation

The low side pressure port (atmospheric reference) on the gage transmitters with aluminum housings are located in the neck of the transmitter, behind the housing. The vent path is 360° around the transmitter between the housing and sensor. (See [Figure 1-3](#).)

Keep the vent path free of any obstruction, including but not limited to paint, dust, and lubrication by mounting the transmitter so that the process can drain away.

Figure 1-3: Gage Low Side Pressure Port

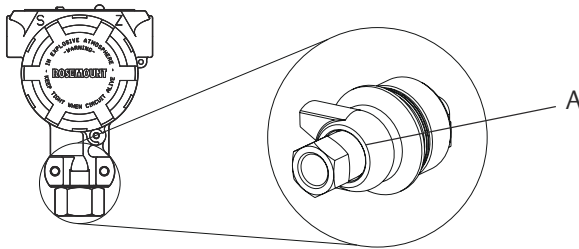

A. Low side pressure port (atmospheric reference)

2 Set the jumpers

If alarm and security jumpers are not installed, the transmitter will operate normally with the default alarm condition alarm high and the security off.

Procedure

1. If the transmitter is installed, secure the loop, and remove power.
2. Remove the housing cover opposite the field terminal side. Do not remove the instrument cover in explosive atmospheres when the circuit is live.
3. Ensure full contact with terminal block screw and washer. When using a direct wiring method, wrap wire clockwise to ensure it is in place when tightening the terminal block screw.

Note

The use of a pin or a ferrule wire terminal is not recommended as the connection may be more susceptible to loosening over time or under vibration.

4. Reposition the jumper. Avoid contact with the leads and the terminals. See [Figure 2-1](#) for the location of the jumper and the ON and OFF positions.
5. Reattach the transmitter cover. The cover must be fully engaged to comply with explosion-proof requirements.

Example

Figure 2-1: Rosemount 2088 Transmitter Electronics Board

Without LCD display

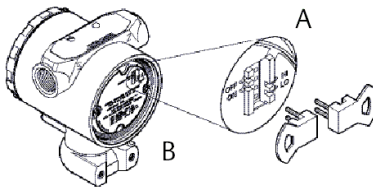

Low power without LCD display

With LCD display

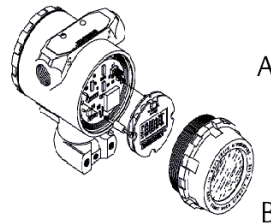

Low power with LCD display

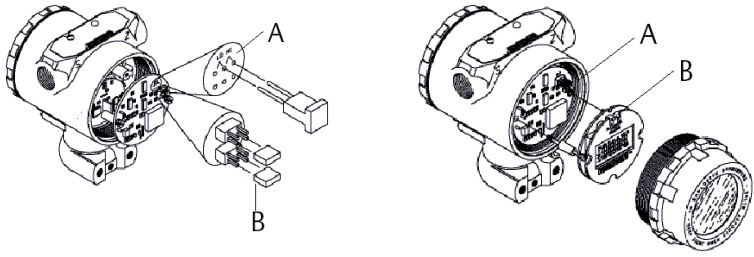

- A. Alarm
 - B. Security
-

3 Connect the wiring and power

Use the following steps to wire the transmitter:

Procedure

1. Remove the housing cover on the side marked field terminals.
2. Connect the positive lead to the “PWR/COMM+” terminal, and the negative lead to the “-” terminal.
3. Ensure proper grounding. It is important that the instrument cable shield:
 - Be trimmed close and insulated from touching the transmitter housing
 - Be connected to the next shield if cable is routed through a junction box
 - Be connected to a good earth ground at the power supply end

Note

Installation of the transient protection terminal block does not provide transient protection unless the Rosemount 2088 case is properly grounded.

Note

Do not connect the powered signal wiring to the test terminals. Power could damage the test diode in the test connection. Twisted pair cable yields best results. For high EMI/RFI environments, shielded twisted pair cable should be used. Use 24 AWG or larger wire and do not exceed 5,000 ft. (1,500 m).

4. Plug and seal unused conduit connections.
5. If applicable, install wiring with a drip loop. Arrange the drip loop so the bottom is lower than the conduit connections and the transmitter housing.
6. Replace the housing cover.

Figure 3-1 and Figure 3-2 show wiring connections necessary to power a Rosemount 2088 Transmitter and enable communications with a hand-held Field Communicator:

Example

Figure 3-1: Bench Hook-up Wiring Diagrams (4–20 mA Transmitters)

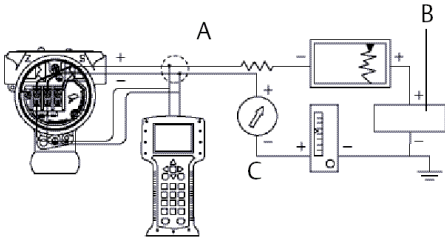

- A. $R_L \geq 250\Omega$
- B. 24 Vdc supply
- C. Current meter

Figure 3-2: Field Wiring for Rosemount 2088 – Low Power Option Code N

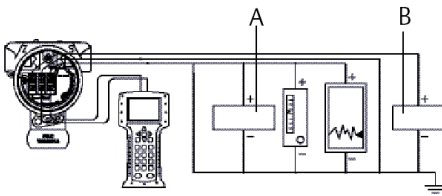

- A. Voltmeter
- B. Power supply

3.1 Power supply

The dc power supply (Option S: 10.5–42.4 V and Option N: 6–14 V) should provide power with less than two percent ripple. The total resistance load is the sum of the resistance of the signal leads and the load resistance of the controller, indicator, and related pieces. The resistance of intrinsic safety barriers, if used, must be included.

Figure 3-3: Maximum Loop Resistance = 43.5 (Power Supply Voltage – 10.5)

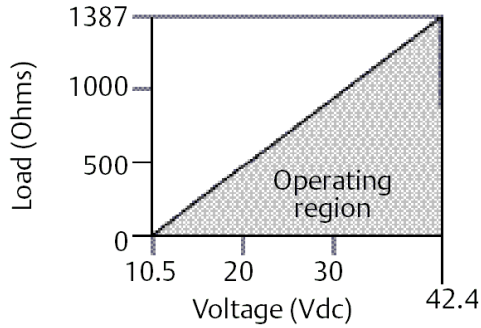

The Field Communicator requires a minimum loop resistance of 250Ω for communication.

4 Verify configuration

A check (✓) indicates the basic configuration parameters. At minimum, these parameters should be verified as part of the configuration and startup procedure.

	Function	HART Fast Key sequence
	Analog Output Alarm	1, 4, 3, 2, 4
	Burst Mode Control	1, 4, 3, 3, 3
	Burst Option	1, 4, 3, 3, 4
	Calibration	1, 2, 3
✓	Damping	1, 3, 5
	Date	1, 3, 4, 1
	Descriptor	1, 3, 4, 2
	Digital To Analog Trim (4–20 mA Output)	1, 2, 3, 2, 1
	Disable Local Span/Zero Adjustment	1, 4, 4, 1, 7
	Field Device Info	1, 4, 4, 1
	Keypad Input	1, 2, 3, 1, 1
	Loop Test	1, 2, 2
	Lower Range Value	4, 1
	Lower Sensor Trim	1, 2, 3, 3, 2
	Message	1, 3, 4, 3
	Meter Type	1, 3, 6, 1
	Number of Requested Preambles	1, 4, 3, 3, 2
	Output Trim	1, 2, 3, 2
	Percent Range	1, 1, 2
	Poll Address	1, 4, 3, 3, 1
✓	Range Values	1, 3, 3
	Rerange	1, 2, 3, 1
	Scaled D/A Trim (4–20 mA Output)	1, 2, 3, 2, 2
	Self Test (Transmitter)	1, 2, 1, 1
	Sensor Info	1, 4, 4, 2
	Sensor Trim (Full Trim)	1, 2, 3, 3

	Function	HART Fast Key sequence
	Sensor Trim Points	1, 2, 3, 3, 5
	Status	1, 2, 1, 2
✓	Tag	1, 3, 1
	Transmitter Security (Write Protect)	1, 3, 4, 4
✓	Units (Process Variable)	1, 3, 2
	Upper Range Value	5, 2
	Upper Sensor Trim	1, 2, 3, 3, 3
	Zero Trim	1, 2, 3, 3, 1

5 Trim the transmitter

Note

Transmitters are shipped fully calibrated per request or by the factory default of full scale (span = upper range limit).

5.1 Zero trim

A zero trim is a single-point adjustment used for compensating mounting position effects. If zero offset is less than 3 percent of true zero, follow the [Using the Field Communicator](#) instructions below. If zero offset is greater than 3 percent of true zero, follow the [Using the transmitter zero adjustment button](#) instructions below to rerange.

5.1.1 Using the Field Communicator

Fast Keys	1, 2, 3, 3, 1
-----------	---------------

Procedure

1. Vent the transmitter and connect Field Communicator.
2. At the menu, input the HART Fast Key sequence.
3. Follow the commands to perform a zero trim.

5.1.2 Using the transmitter zero adjustment button

Procedure

1. Loosen the certifications label screw and rotate the label to expose the zero adjustment button.
2. Apply the desired pressure for the 4 mA output.
3. Set the 4 mA point by pressing the zero button for two seconds. Verify that the output is 4 mA. The optional LCD display will show "ZERO PASS".

Example

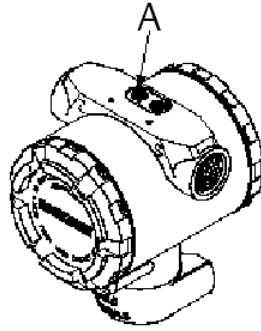

A. Zero adjustment button

6 Safety instrumented systems

The following section applies to Rosemount 2088 Transmitters used in SIS applications.

Note

Transmitter output is not safety-rated during the following: configuration changes, multidrop, loop test. Alternative means should be used to ensure process safety during transmitter configuration and maintenance activities.

6.1 Installation

No special installation is required in addition to the standard installation practices outlined in this document. Always ensure a proper seal by installing the electronics housing cover(s) so that metal contacts metal.

The loop must be designed so the terminal voltage does not drop below 10.5 Vdc when the transmitter output is 22.5 mA.

Position the security switch to the "ON" position to prevent accidental or deliberate change of configuration data during normal operation.

6.2 Configuration

Use any HART-compliant master to communicate with and verify configuration of the Rosemount 2088.

User-selected damping will affect the transmitters ability to respond to changes in the applied process. The damping value + response time must not exceed the loop requirements.

Note

DCS or safety logic solver must be configured to match transmitter configuration. [Figure 6-1](#) identifies the two alarm levels available and their operation values. Position the alarm switch to the required HI or LO alarm position.

Figure 6-1: Alarm Levels

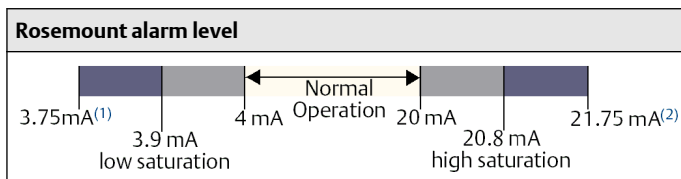

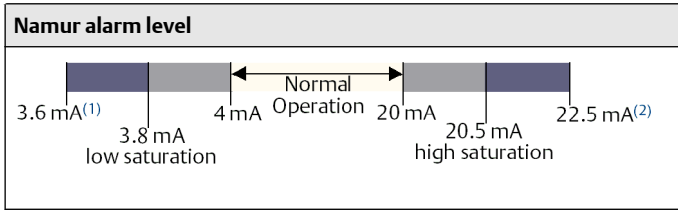

- A. Transmitter Failure, hardware alarm in LO position.
 B. Transmitter Failure, hardware alarm in HI position.

Note

Some detected faults are indicated on the analog output at a level above high alarm regardless of the alarm switch selection.

6.3 Operation and maintenance

6.3.1 Proof test and inspection

The following proof tests are recommended. Proof test results and corrective actions taken must be documented at Emerson.com/Rosemount/Safety in the event that an error is found in the safety functionality.

Use [Table 7-1](#) to perform a Loop Test, Analog Output Trim, or Sensor Trim. See the [Rosemount 2088 Reference Manual](#) for additional information.

6.3.2 Proof test

This proof test will detect 92 percent of DU failures not detected by the Rosemount 2088 automatic diagnostics.

Procedure

1. Bypass the safety PLC and take appropriate action to avoid a false trip.
2. Send a HART command to the transmitter to go to the high alarm current output and verify that the analog current reaches that value.⁽¹⁾
3. Send a HART command to the transmitter to go to the low alarm current output and verify that the analog current reaches that value.⁽²⁾
4. Perform a minimum two-point sensor calibration check using the 4-20 mA range points as the calibration points and verify that the mA output corresponds to the pressure input value.⁽³⁾
5. Restore loop to full operation.

⁽¹⁾ This tests for compliance voltage problems such as a low loop power supply voltage or increased wiring resistance. This also tests for other possible failures.

⁽²⁾ This tests for possible quiescent current related failures.

⁽³⁾ If the two-point calibration is performed with electrical instrumentation, this proof test will not detect any failures of the sensor.

6. Remove the bypass and otherwise restore normal operation.

6.3.3 Product repair

All failures detected by the transmitter diagnostics or by the proof-test must be reported. Feedback can be submitted electronically at [Emerson.com/Rosemount/Safety](https://emerson.com/Rosemount/Safety).

The Rosemount 2088 is repairable by major component replacement. Follow the instructions in the [Rosemount 2088 Reference Manual](#) for additional information.

6.4 Reference

6.4.1 Specifications

The Rosemount 2088 must be operated in accordance to the functional and performance specifications provided in the [Rosemount 2088 Reference Manual](#).

6.4.2 Failure rate data

The FMEDA report includes failure rates. This report is available at [Emerson.com/Rosemount](https://emerson.com/Rosemount).

6.4.3 2088 safety failure values

Safety accuracy: 2.0% Safety response time: 1.5 sec

Note

A 2% variation of the transmitter mA output is allowed before a safety trip. Trip values in the DCS or safety logic solver should be derated by 2%.

Safety response time: 1.5 sec

6.4.4 Product life

50 years – based on worst case component wear-out mechanisms – not based on wear-out process wetted materials.

7 Product Certifications

7.1 Rosemount™ 2088

Mount directly to the impulse line without using an additional mounting bracket or mount directly to a wall, panel, or two-inch pipe using an optional mounting bracket.

7.1.1 European Directive Information

A copy of the EU Declaration of Conformity can be found at the end of the Quick Start Guide. The most recent revision of the EU Declaration of Conformity can be found at Emerson.com/Rosemount.

7.1.2 Ordinary Location Certification

As standard, the transmitter has been examined and tested to determine that the design meets the basic electrical, mechanical, and fire protection requirements by a nationally recognized test laboratory (NRTL) as accredited by the Federal Occupational Safety and Health Administration (OSHA).

7.1.3 North America

E5 USA Explosionproof (XP) and Dust-Ignitionproof (DIP)

Certificate: 1V2A8.AE

Standards: FM Class 3600 – 2011, FM, Class 3615 – 2006, FM Class 3616 – 2011, FM Class 3810 – 2005, ANSI/NEMA 250 – 1991

Markings: XP CL I, DIV 1, GP B, C, D; DIP CL II, DIV 1, GP E, F, G; CL III; T5(–40 °C ≤ T_a ≤ +85 °C); Factory Sealed; Type 4X

I5 USA Safety (IS) and Nonincendive (NI)

Certificate: 0V9A7.AX

Standards: FM Class 3600 – 1998, FM Class 3610 – 2010, FM Class 3611 – 2004, FM Class 3810 – 1989

Markings: IS CL I, DIV 1, GP A, B, C, D; CL II, DIV 1, GP E, F, G; Class III; DIV 1 when connected per Rosemount drawing 02088-1018; NI CL 1, DIV 2, GP A, B, C, D; T4(–40 °C ≤ T_a ≤ +70 °C); Type 4x

Special Condition for Safe Use (X):

1. The Rosemount 2088 Transmitter with the transient terminal block (Option code T1) will not pass the 500 Vrms dielectric strength test and this must be taken into account during installation.

C6 Canada Explosionproof, Intrinsic Safety and Division 2, Dust-Ignitionproof

Certificate: 1015441

Standards: CAN/CSA C22.2 No. 0-M91 (R2001), CSA Std C22.2 No. 25-1966, CSA Std C22.2 No. 30-M1986, CAN/CSA-C22.2 No. 94-M91, CSA Std C22.2 No. 142-M1987, CAN/CSA-C22.2 No. 157-92, CSA Std C22.2 No. 213-M1987, ANSI-ISA-12.27.01-2003

Markings: Explosionproof for Class I, Division 1, Groups B,C and D; Dust-Ignitionproof Class II, Division 1, Groups E, F, G; Class III Division 1; Intrinsically Safe Class I, Division 1 Groups A, B, C, D when connected in accordance with Rosemount drawing 02088-1024, Temperature Code T3C; Class I Division 2 Groups A, B, C and D; Type 4X; Factory Sealed; Single Seal

7.1.4 Europe

ED ATEX Flameproof

Certificate: KEMA97ATEX2378X

Standards: EN60079-0:2012 + A11:2013, EN60079-1:2014, EN60079-26:2015

Markings: Ⓢ II 1/2 G Ex db IIC T6....T4, Ga/Gb, T6(-60 °C ≤ T_a ≤ +70 °C), T4/T5(-60 °C ≤ T_a ≤ +80 °C)

Special Conditions for Safe Use (X):

1. This device contains a thin wall diaphragm. Installation, maintenance and use shall take into account the environmental conditions to which the diaphragm will be subjected. The manufacturer's instructions for installation and maintenance shall be followed in detail to assure safety during its expected lifetime.
2. Flameproof joints are not intended for repair.
3. Non-standard paint options may cause risk from electrostatic discharge. Avoid installations that could cause electrostatic build-up on painted surfaces, and only clean the painted surfaces with a damp cloth. If paint is ordered through a special option code, contact the manufacturer for more information.

I1 ATEX Intrinsic Safety

Certificate: BAS00ATEX1166X

Standards: EN60079-0:2012 + A11:2013, EN60079-11:2012

Markings:  II 1 G Ex ia IIC T4 Ga ($-55\text{ °C} \leq T_a \leq +70\text{ °C}$)

Table 7-1: Input Parameters

Parameter	HART
Voltage U_i	30 V
Current I_i	200 mA
Power P_i	0.9 W
Capacitance C_i	0.012 μF

Special Condition for Safe Use (X):

1. The apparatus is not capable of withstanding the 500 V insulation test required by EN60079-11. This must be taken into account when installing the apparatus.

N1 ATEX Type n

Certificate: BAS00ATEX3167X

Standards: EN60079-0:2012 + A11:2013, EN60079-15:2010

Markings:  II 3 G Ex nA IIC T5 Gc ($-40\text{ °C} \leq T_a \leq +70\text{ °C}$)

Special Condition for Safe Use (X):

1. The apparatus is not capable of withstanding the 500 V insulation test required by EN60079-15. This must be taken into account when installing the apparatus.

ND ATEX Dust

Certificate: BAS01ATEX1427X

Standards: EN60079-0:2012 + A11:2013, EN60079-31:2009

Markings: II 1 D Ex t IIIC T50 °C T₅₀₀ 60 °C Da

Special Conditions for Safe Use (X):

1. The user must ensure the maximum rated voltage and current (36 volts, 24 milliamps, d.c.) are not exceeded. All connection to other apparatus or associated apparatus shall have control over this voltage and current to a category 'ib' circuit.
2. Cable entries must be used which maintain the ingress protection of the enclosure to at least IP66.
3. Unused cable entries must be filled with suitable blanking plugs which maintain the ingress protection of the enclosure to at least IP66.

4. Cable entries and blanking plugs must be suitable for the ambient range of the apparatus and capable of withstanding a 7 J impact test.
5. The Rosemount 2088/2090 sensor module must be securely screwed in place to maintain the ingress protection of the enclosure.

7.1.5 International

E7 IECEx Flameproof

Certificate: IECEx KEM 06.0021X

Standards: IEC 60079-0:2011, IEC60079-1:2014, IEC60079-26:2014

Markings: Ex d IIC T6...T4 Ga/Gb, T6($-60\text{ }^{\circ}\text{C} \leq T_a \leq +70\text{ }^{\circ}\text{C}$), T4/T5 ($-60\text{ }^{\circ}\text{C} \leq T_a \leq +80\text{ }^{\circ}\text{C}$)

Special Conditions for Safe Use (x):

1. This device contains a thin wall diaphragm. Installation, maintenance and use shall take into account the environmental conditions to which the diaphragm will be subjected. The manufacturer's instructions for installation and maintenance shall be followed in detail to assure safety during its expected lifetime.
2. Flameproof joints are not intended for repair.
3. Non-standard paint options may cause risk from electrostatic discharge. Avoid installations that could cause electrostatic build-up on painted surfaces, and only clean the painted surfaces with a damp cloth. If paint is ordered through a special option code, contact the manufacturer for more information.

I7 IECEx Intrinsic Safety

Certificate: IECEx BAS 12.0071X

Standards: IEC60079-0:2011, IEC60079-11:2011

Markings: Ex ia IIC T4 Ga ($-55\text{ }^{\circ}\text{C} \leq T_a \leq +70\text{ }^{\circ}\text{C}$)

Table 7-2: Entity Parameters

Parameter	HART
Voltage U_i	30 V
Current I_i	200 mA
Power P_i	0.9 W
Capacitance C_i	0.012 μF

Special Conditions for Safe Use (X):

1. When fitted with a transient suppression terminal block, the Rosemount 2088 is incapable of passing the 500 V isolation test. This must be taken into account during installation.
2. The enclosure may be made of aluminum alloy and given a protective polyurethane paint finish; however, care should be taken to protect it from impact or abrasion if located in a Zone 0 environment.

N7 IECEx Type n

Certificate:	IECEX BAS 12.0072X
Standards:	IEC60079-0:2011, IEC60079-15:2010
Markings:	Ex nA IIC T5 Gc (-40 °C ≤ T _a ≤ +70 °C)

Special Condition for Safe Use (X):

1. When fitted with a transient suppression terminal block, the Rosemount 2088 is incapable of passing the 500 V isolation test. This must be taking into account during installation.

NK IECEx Dust

Certificate:	IECEX BAS12.0073X
Standards:	IEC60079-0:2011, IEC60079-31:2008
Markings:	Ex t IIIC T50 °C T ₅₀₀ 60 °C Da

Table 7-3: Input Parameters

Parameter	HART
Voltage U _i	36 V
Current I _i	24 mA

Special Conditions For Safe Use (x):

1. Cable entries must be used which maintain the ingress protection of the enclosure to at least IP66.
2. Unused cable entries must be filled with suitable blanking plugs which maintain the ingress protection of the enclosure to at least IP66.
3. Cable entries and blanking plugs must be suitable for the ambient range of the apparatus and capable of withstanding a 7 J impact.

7.1.6 Brazil

E2 INMETRO Flameproof

Certificate: UL-BR 15.0728X

Standards: ABNT NBR IEC60079-0:2008 + Errata 1:2011, ABNT NBR IEC 60079-1:2009 + Errata 1:2011

Markings: Ex d IIC T* Gb, *T4($-20\text{ °C} \leq T_a \leq +80\text{ °C}$), *T6($-20\text{ °C} \leq T_a \leq +40\text{ °C}$)

Special Conditions For Safe Use (x):

1. This device contains a thin wall diaphragm less than 1mm thickness that forms a boundary between zone 0 (process connection) and zone 1 (all other parts of the equipment). The model code and data sheet are to be consulted for details of the diaphragm material. Installations, maintenance and use shall take into account the environmental conditions to which the diaphragm will be subjected. The manufacturer's instructions for installation and maintenance shall be followed in detail to assure safety during its expected lifetime.
2. Flameproof joints are not intended for repair.
3. Non-standard paint options may cause risk from electrostatic discharge. Avoid installations that could cause electrostatic build-up on painted surfaces, and only clean the painted surfaces with a damp cloth. If paint is ordered through a special option code, contact the manufacturer for more information.

I2 INMETRO Intrinsic Safety

Certificate: UL-BR 13.0246X

Standards: ABNT NBR IEC60079-0:2008 + Errata 1:2011, ABNT NBR IEC60079-11:2009

Markings: Ex ia IIC T4 Ga ($-55\text{ °C} \leq T_a \leq +70\text{ °C}$)

Table 7-4: Input Parameters

Parameter	HART
Voltage U_i	30 V
Current I_i	200 mA
Power P_i	0.9 W
Capacitance C_i	0.012 μ F

Special Conditions for Safe Use (X):

1. When fitted with a transient suppression terminal block, the Rosemount 2088 is incapable of passing the 500 V isolation test. This must be taken into account when installing the equipment.
2. The enclosure may be made of aluminum alloy and given a protective polyurethane paint finish; however, care should be taken to protect it from impact or abrasion if located in Zone 0.

7.1.7 China

E3 China Flameproof**Certificate:** GYJ15.1505**Standards:** GB3836.1-2010, GB3836.2-2010**Markings:** Ex d IIC T4/T6 Gb, T6($-20\text{ }^{\circ}\text{C} \leq T_a \leq +40\text{ }^{\circ}\text{C}$), T4($-20\text{ }^{\circ}\text{C} \leq T_a \leq +80\text{ }^{\circ}\text{C}$)**Special Conditions For Safe Use (X):**

1. The ambient temperature is as follows:

T_a	Temperature class
$-20\text{ }^{\circ}\text{C} \leq T_a \leq 80\text{ }^{\circ}\text{C}$	T4
$-20\text{ }^{\circ}\text{C} \leq T_a \leq 40\text{ }^{\circ}\text{C}$	T6

2. The earth connection facility in the enclosure should be connected reliably.
3. During installation in hazardous location, cable glands, conduits, and blanking plugs, certified by state-appointed inspection bodies with Ex d IIC type of protection, should be used.
4. During installation, use and maintenance in explosive gas atmospheres, observe the warning "Do not open when energized".
5. During installation, there should be no mixture harm to flameproof housing.
6. End user is not permitted to change any components insides, but to settle the problem in conjunction with manufacturer to avoid damage to the product.
7. Maintenance should be done in non-hazardous location.
8. During installation, use and maintenance of this product, observe the following standards: GB3836.13-2013, GB3836.15-2000, GB3836.16-2006, GB50257-2014.

I3 China Intrinsic Safety

Certificate: GYJ15.1507

Standards: GB3836.1-2010, GB3836.4-2010, GB3836.20-2010

Markings: Ex ia IIC T4/T5 Ga

Special Conditions for Safe Use (X):

1. The enclosure may be made of aluminum alloy and given a protective polyurethane paint finish; however, care should be taken to protect it from impact or abrasion if located in a zone 0 environment.
2. This apparatus is not capable of withstanding the 500 V r.m.s. insulation test required by Clause 6.3.12 of GB3836.4-2010.
3. The ambient temperature is:

T_a	Temperature class
$-55\text{ °C} \leq T_a \leq 70\text{ °C}$	T4

4. Intrinsically safe parameters:

Parameter	HART
Voltage U_i	30 V
Current I_i	200 mA
Power P_i	0.9 W
Capacitance C_i	0.012 μF
Inductance L_i	0 mH

5. The product should be used with Ex-certified linear associated apparatus to establish explosion protection system that can be used in explosive gas atmospheres. Wiring and terminals should comply with the instruction manual of the product and associated apparatus.
6. The cables between this product and associated apparatus should be shielded cables (the cables must have insulated shields). The shield has to be grounded reliably in a non-hazardous area.
7. End users are not permitted to change any internal components, but to settle the problem in conjunction with the manufacturer to avoid damage to the product.
8. During installation, use and maintenance of this product, observe the following standards: GB3836.13-2013, GB3836.15-2000, GB3836.16-2006, GB3836.18-2010, GB50257-2014.

N3 China Type n

Certificate:	GYJ15.1108X
Standards:	GB3836.1-2000, GB3836. 8-2003
Markings:	Ex nA nL IIC T5 Gc ($-40^{\circ}\text{C} \leq T_a \leq +70^{\circ}\text{C}$)

Special Conditions For Safe Use (X):

1. The apparatus is not capable of withstanding the 500 V r.m.s. insulation test required by GB3836.8-2003.
2. The ambient temperature range is $-40^{\circ}\text{C} \leq T_a \leq +70^{\circ}\text{C}$.
3. Maximum input voltage: 50 V.
4. Cable glands, conduit or blanking plugs, certified by NEPSI with Ex e or Ex n protection types should be used on external connections and redundant cable entries.
5. Maintenance should be done in non-hazardous location.
6. End users are not permitted to change any internal components, but to settle the problem in conjunction with manufacturer to avoid damage to the product.
7. During installation, use and maintenance of this product, observe the following standards: GB3836.13-2013, GB3836.15-2000, GB3836.16-2006, GB50257-1996.

7.1.8 Japan

E4 Japan Flameproof

Certificate:	TC20869, TC20870
Markings:	Ex d IIC T5

7.1.9 Technical Regulations Customs Union (EAC)

EM EAC Flameproof

Certificate:	RU C-US.GB05.B.01197
Markings:	Ga/Gb Ex d IIC T4/T6 X, T4($-40^{\circ}\text{C} \leq T_a \leq +80^{\circ}\text{C}$), T6($-40^{\circ}\text{C} \leq T_a \leq +40^{\circ}\text{C}$)

Special Condition for Safe Use (X):

1. See certificate for special conditions.

IM EAC Intrinsically Safe

Certificate: RU C-US.GB05.B.01197

Markings: 0Ex ia IIC T4 Ga X ($-55\text{ °C} \leq T_a \leq +70\text{ °C}$)

7.1.10 Combinations

K1 Combination of ED, I1, ND and N1

K2 Combination of E2 and I2

K5 Combination of E5 and I5

K6 Combination of C6, ED and I1

K7 Combination of E7, I7, NK and N7

KB Combination of K5 and C6

KM Combination of EM and IM

KH Combination of ED, I1, K5

7.1.11 Conduit Plugs and Adapters

IECEx Flameproof and Increased Safety

Certificate: IECEx FMG 13.0032X

Standards: IEC60079-0:2011, IEC60079-1:2007-04, IEC60079-7:2006-07

Markings: Ex de IIC Gb

ATEX Flameproof and Increased Safety

Certificate: FM13ATEX0076X

Standards: EN60079-0:2012, EN60079-1:2007, IEC60079-7:2007

Markings:  II 2 G Ex de IIC Gb

Table 7-5: Conduit Plug Thread Sizes

Thread	Identification mark
M20 × 1.5 – 6g	M20
1/2–14 NPT	1/2 NPT
G1/2A	G1/2

Table 7-6: Thread Adapter Thread Sizes

Male thread	Identification mark
-------------	---------------------

Table 7-6: Thread Adapter Thread Sizes
(continued)

M20 × 1.5 – 6H	M20
1/2–14 NPT	1/2–14 NPT
3/4–14 NPT	3/4–14 NPT
Female thread	Identification mark
M20 × 1.5 – 6H	M20
1/2–14 NPT	1/2–14 NPT
G1/2	G1/2

Special Conditions For Safe Use (X):

1. When the thread adapter or blanking plug is used with an enclosure in type of protection increased safety “e” the entry thread shall be suitably sealed in order to maintain the ingress protection rating (IP) of the enclosure.
2. The blanking plug shall not be used with an adapter.
3. Blanking Plug and Threaded Adapter shall be either NPT or Metric thread forms. G1/2 thread forms are only acceptable for existing (legacy) equipment installations.

7.1.12 Additional Certifications

SBS American Bureau of Shipping (ABS) Type Approval

Certificate: 09-HS446883D-3-PDA

Intended Use: Measure gauge or absolute pressure of liquid, gas or vapor applications on ABS classed vessels, marine, and offshore installations.

ABS Rules: 2014 Steel Vessels Rules 1-1-4/7.7, 1-1-Appendix 3, 4-8-3/1.7, 4-8-3/13.1, 4-8-3/13.3.1 & 13.3.2, 4-8-4/27.5.1

SBV Bureau Veritas (BV) Type Approval

Certificate: 23156/B0 BV

Requirements: Bureau Veritas Rules for the Classification of Steel Ships

Application: Class notations: AUT-UMS, AUT-CCS, AUT-PORT and AUT-IMS; Pressure transmitter type 2088 cannot be installed on diesel engines

SDN Det Norske Veritas (DNV) Type Approval

Certificate: TAA000004F

Intended Use: DNV GL Rules for Classification - Ships and offshore units

Application:

Location classes	
Temperature	D
Humidity	B
Vibration	A
EMC	B
Enclosure	D

SLL Lloyds Register (LR) Type Approval

Certificate: 11/60002

Application: Environmental categories ENV1, ENV2, ENV3 and ENV5

7.2 Rosemount 2090 Product Certification

Rev 1.6

7.2.1 European Directive Information

A copy of the EU Declaration of Conformity can be found at the end of the Quick Start Guide. The most recent revision of the EU Declaration of Conformity can be found at EmersonProcess.com/Rosemount.

7.2.2 Ordinary Location Certification

As standard, the transmitter has been examined and tested to determine that the design meets the basic electrical, mechanical, and fire protection requirements by a nationally recognized test laboratory (NRTL) as accredited by the Federal Occupational Safety and Health Administration (OSHA).

7.2.3 North America

E5 USA Explosionproof (XP) and Dust-Ignitionproof (DIP)

Certificate: 1V2A8.AE

Standards: FM Class 3600 – 2011, FM Class 3615 – 2006, FM class 3616 – 2011, FM Class 3810 – 2005, ANSI/NEMA 250 – 1991

Markings: XP CL I, DIV 1, GP B, C, D; DIP CL II, DIV 1, GP E, F, G; CL III, DIV 1; T5(-40 °C ≤ T_a ≤ +85 °C); Factory Sealed; Type 4X

15 USA Intrinsic Safety (IS) and Nonincendive (NI)

Certificate: 0V9A7.AX

Standards: FM Class 3600 – 1998, FM Class 3610 – 2010, FM Class 3611 – 2004, FM Class 3810 – 1989

Markings: IS CL I, DIV 1, GP A, B, C, D; CL II, DIV 1, GP E, F, G; Class III; DIV 1 when connected per Rosemount drawing 02088-1018; NI CL 1, DIV 2, GP A, B, C, D; T4(–40 °C ≤ T_a ≤ +70 °C); Type 4x

Special Condition for Safe Use (X):

1. The Rosemount 2090 Transmitter with the transient terminal block (option code T1) will not pass the 500 V r.m.s.dielectric strength test and this must be taken into account during installation.

C6 Canada Explosionproof, Intrinsically Safe, and Division 2, Dust-Ignitionproof

Certificate: 1015441

Standards: CAN/CSA C22.2 No. 0-M91 (R2001), CSA Std C22.2 No. 25-1966, CSA Std C22.2 No. 30-M1986, CAN/CSA-C22.2 No. 94-M91, CSA Std C22.2 No. 142-M1987, CAN/CSA-C22.2 No. 157-92, CSA Std C22.2 No. 213-M1987, ANSI-ISA-12.27.01-2003

Markings: Explosionproof for Class I, Division 1, Groups B, C and D; Class II, Groups E, F, and G; Class III; Intrinsically Safe Class I, Division 1 when connected in accordance with Rosemount drawing 02088-1024, Temperature Code T3C; Ex ia; Class I Division 2 Groups A, B, C and D; Type 4X; Factory Sealed

7.2.4 Europe

ED ATEX Flameproof

Certificate: KEMA97ATEX2378X

Standards: EN60079-0:2012 + A11:2013, EN60079-1:2014, EN60079-26:2015

Markings: Ⓢ II 1/2 G Ex db IIC T6... T4, T6(–60 °C ≤ T_a ≤ +70 °C), T4/T5(–60 °C ≤ T_a ≤ +80 °C)

Special Conditions for Safe Use (X):

1. This device contains a thin wall diaphragm. Installation, maintenance and use shall take into account the environmental conditions to which the diaphragm will be subjected. The manufacturer's instructions for

installation and maintenance shall be followed in detail to assure safety during its expected lifetime.

2. Flameproof joints are not intended for repair.
3. Non-standard paint options may cause risk from electrostatic discharge. Avoid installations that could cause electrostatic build-up on painted surfaces, and only clean the painted surfaces with a damp cloth. If paint is ordered through a special option code, contact the manufacturer for more information.

I1 ATEX Intrinsic Safety

Certificate: BAS00ATEX1166X

Standards: EN60079-0:2012, EN60079-11:2012

Markings: Ⓢ II 1 G Ex ia IIC T5/T4 Ga, T5($-55\text{ °C} \leq T_a \leq +40\text{ °C}$), T4($-55\text{ °C} \leq T_a \leq +70\text{ °C}$)

Table 7-7: Input Parameters

Parameter	HART
Voltage U_i	30 V
Current I_i	200 mA
Power P_i	0.9 W
Capacitance C_i	0.012 μF

Special Condition for Safe Use (X):

1. The apparatus is not capable of withstanding the 500 V insulation test required by EN60079-11. This must be taken into account when installing the apparatus.

N1 ATEX Type n

Certificate: BAS00ATEX3167X

Standards: EN60079-0:2012, EN60079-15:2010

Markings: Ⓢ II 3 G Ex nA IIC T5 Gc ($-40\text{ °C} \leq T_a \leq +70\text{ °C}$)

Special Condition for Safe Use (X):

1. This apparatus is not capable of withstanding the 500 V insulation test that is required by EN60079-15. This must be taken into account when installing the apparatus.

ND ATEX Dust

Certificate:	BAS01ATEX1427X
Standards:	EN60079-0:2012, EN60079-31:2009
Markings:	Ex t IIIC T 50 °C T ₅₀₀ 60 °C Da

Special Conditions for Safe Use (X):

1. The user must ensure that the maximum rated voltage and current (36 volts, 24 milliamps, d.c.) are not exceeded. All connection to other apparatus or associated apparatus shall have control over this voltage and current to a category 'ib' circuit.
2. Cable entries must be used which maintain the ingress protection of the enclosure to at least IP66.
3. Unused cable entries must be filled with suitable blanking plugs which maintain the ingress protection of the enclosure to at least IP66.
4. Cable entries and blanking plugs must be suitable for the ambient range of the apparatus and capable of withstanding a 7 J impact test.
5. The Rosemount 2090 sensor module must be securely screwed in place to maintain the ingress protection of the enclosure.

7.2.5 International

K7 Combination

IECEx Flameproof

Certificate:	IECEx KEM 06.0021X
Standards:	IEC60079-0:2011, IEC60079-1:2014, IEC60079-26:2014
Markings:	Ex db IIC T6...T4 Ga/Gb, T6(-60 °C ≤ T _a ≤ +70 °C), T4/T5(-60 °C ≤ T _a ≤ +80 °C)

Special Conditions for Safe Use (X):

1. This device contains a thin wall diaphragm. Installation, maintenance and use shall take into account the environmental conditions to which the diaphragm will be subjected. The manufacturer's instructions for installation and maintenance shall be followed in detail to assure safety during its expected lifetime.
2. Flameproof joints are not intended for repair.
3. Non-standard paint options may cause risk from electrostatic discharge. Avoid installations that could cause electrostatic build-up on painted surfaces, and only clean the painted surfaces with a damp

cloth. If paint is ordered through a special option code, contact the manufacturer for more information.

IECEx Dust

Certificate:	IECEx BAS12.0073X
Standards:	IEC60079-0:2011, IEC60079-31:2008
Markings:	Ex t IIIC T 50 °C T ₅₀₀ 60 °C Da

Table 7-8: Input Parameters

Parameter	HART
Voltage U _i	36 Vdc
Current I _i	24 mA

Special Conditions for Safe Use (X):

1. Cable entries must be used which maintain the ingress protection of the enclosure to at least IP66.
2. Unused cable entries must be filled with suitable blanking plugs which maintain the ingress protection of the enclosure to at least IP66.
3. Cable entries and blanking plugs must be suitable for the ambient temperature range of the apparatus and capable of withstanding a 7 J impact test.

IECEx Intrinsic Safety

Certificate:	IECEx BAS 12.0071X
Standards:	IEC60079-0:2011, IEC60079-11:2011
Markings:	Ex ia IIC T5/T4 Ga, T5(-55 °C ≤ T _a ≤ +40 °C), T4(-55 °C ≤ T _a ≤ +70 °C)

Table 7-9: Input Parameters

Parameter	HART
Voltage U _i	30 V
Current I _i	200 mA
Power P _i	0.9 W
Capacitance C _i	0.012 μF

Special Conditions for Safe Use (X):

1. When fitted with a transient suppression terminal block, the Rosemount 2090 is incapable of passing the 500 V isolation test. This must be taken into account during installation.
2. The enclosure may be made of aluminum alloy and given a protective polyurethane paint finish; however, care should be taken to protect it from impact or abrasion if located in a Zone 0 environment.

IECEx Type n

Certificate:	IECEx BAS 12.0072X
Standards:	IEC60079-0:2011, IEC60079-15:2010
Markings:	Ex nA IIC T5 Gc (-40 °C ≤ T _a ≤ +70 °C)

Special Conditions for Safe Use (X):

1. When fitted with a transient suppression terminal block, the Rosemount 2090 is incapable of passing the 500 V isolation test. This must be taken into account during installation.

NK IECEx Dust

Certificate:	IECEx BAS12.0073X
Standards:	IEC60079-0:2011, IEC60079-31:2008
Markings:	Ex t IIIC T 50 °C T ₅₀₀ 60 °C Da

Table 7-10: Input Parameters

Parameter	HART
Voltage U _i	36 Vdc
Current I _i	24 mA

Special Conditions for Safe Use (X):

1. Cable entries must be used which mention the ingress protection of the enclosure to at least IP66.
2. Unused cable entries must be filled with suitable blanking plugs which maintain the ingress protection of the enclosure to at least IP66.
3. Cable entries and blanking plugs must be suitable for the ambient range of the apparatus and capable of withstanding a 7 J impact test.

7.2.6 China

E3 China Flameproof

Certificate: GYJ15.1506X

Standards: GB3836.1-2010, GB3836.2-2010

Markings: Ex d IIC T6/T4 Gb, T6($-20\text{ °C} \leq T_a \leq +40\text{ °C}$), T4($-20\text{ °C} \leq T_a \leq +80\text{ °C}$)

Special Conditions for Safe Use (X):

1. The ambient temperature is as follows:

T_a	Temperature class
$-20\text{ °C} \leq T_a \leq 80\text{ °C}$	T4
$-20\text{ °C} \leq T_a \leq 40\text{ °C}$	T6

2. The earth connection facility in the enclosure should be connected reliably.
3. During installation in hazardous location, cable glands, conduits, and blanking plugs, certified by state-appointed inspection bodies with Ex d IIC type of protection, should be used.
4. During installation, use and maintenance in explosive gas atmospheres, observe the warning “Do not open when energized.”
5. During installation, there should be no mixture harm to flameproof housing.
6. End user is not permitted to change any components insides, but to settle the problem in conjunction with manufacturer to avoid damage to the product.
7. Maintenance should be done in non-hazardous location.
8. During installation, use and maintenance of this product, observe the following standards: GB3836.13-2013, GB3836.15-2000, GB3836.16-2006, GB50257-2014.

I3 China Intrinsic Safety

Certificate: GYJ15.1508X

Standards: GB3836.1-2010, GB3836.4-2010, GB3836.20-2010

Markings: Ex ia IIC T4/T5 Ga

Special Conditions for Safe Use (X):

1. The enclosure may be made of aluminum alloy and given a protective polyurethane paint finish; however, care should be taken to protect it from impact or abrasion if located in a zone 0 environment.
2. This apparatus is not capable of withstanding the 500 V r.m.s. insulation test required by Clause 6.3.12 of GB3836.4-2010.
3. The ambient temperature is:

T_a	Temperature class
$-55\text{ }^\circ\text{C} \leq T_a \leq 40\text{ }^\circ\text{C}$	T5
$-55\text{ }^\circ\text{C} \leq T_a \leq 70\text{ }^\circ\text{C}$	T4

4. Intrinsically safe parameters:

Parameter	HART
Voltage U_i	30 V
Current I_i	200 mA
Power P_i	0.9 W
Capacitance C_i	0.012 μF
Inductance L_i	0 mH

5. The product should be used with Ex-certified linear associated apparatus to establish explosion protection system that can be used in explosive gas atmospheres. Wiring and terminals should comply with the instruction manual of the product and associated apparatus.
6. The cables between this product and associated apparatus should be shielded cables (the cables must have insulated shields). The shield has to be grounded reliably in a non-hazardous area.
7. End users are not permitted to change any internal components, but to settle the problem in conjunction with the manufacturer to avoid damage to the product.
8. During installation, use and maintenance of this product, observe the following standards: GB3836.13-2013, GB3836.15-2000, GB3836.16-2006, G3836.18-2010, GB50257-2014.

7.2.7 Technical Regulations Customs Union (EAC)

EM EAC Flameproof

Certificate: RU C-US.GB05.B.01197

Markings: Ga/Gb Ex d IIC T4/T6 X, T4(-40 °C ≤ T_a ≤ +80 °C), T6(-40 °C ≤ T_a ≤ +40 °C)

Special Conditions for Safe Use (X):

See certificate for special conditions.

IM EAC Intrinsically Safe

Certificate: RU C-US.GB05.B.01197

Markings: 0Ex ia IIC T4 Ga X (-55 °C ≤ T_a ≤ +70 °C)

Special Conditions for Safe Use (X):

See certificate for special conditions.

7.2.8 Combinations

K1 Combination of ED, I1, ND, and N1

K5 Combination of E5 and I5

K6 Combination of C6, ED, and I1

K7 Combination of E7, I7, NK, and N7

KB Combination of K5 and C6

KM Combination of EM and IM

KH Combination of ED, I1, and K5

7.2.9 Conduit plugs and adapters

IECEx Flameproof and Increased Safety

Certificate: IECEx FMG 13.0032X

Standards: IEC60079-0:2011, IEC60079-1:2007, IEC60079-7:2006-2007

Markings: Ex de IIC Gb

ATEX Flameproof and Increased Safety

Certificate: FM13ATEX0076X

Standards: EN60079-0:2012, EN60079-1:2007, EN60079-7:2007

Markings:  II 2 G Ex de IIC Gb

Table 7-11: Conduit Plug Thread Sizes

Thread	Identification mark
M20 × 1.5	M20
1/2–14 NPT	1/2 NPT
G1/2A	G1/2



Table 7-12: Thread Adapter Thread Sizes

Male thread	Identification mark
M20 × 1.5 – 6H	M20
1/2–14 NPT	1/2–14 NPT
3/4–14 NPT	3/4–14 NPT
Female thread	Identification mark
M20 × 1.5 – 6H	M20
1/2–14 NPT	1/2–14 NPT
PG 13.5	PG 13.5

Special Conditions for Safe Use (X):

1. When the thread adapter or blanking plug is used with an enclosure in type of protection increased safety “e” the entry thread shall be suitably sealed in order to maintain the ingress protection rating (IP) of the enclosure.
2. The blanking plug shall not be used with an adapter.
3. Blanking Plug and Threaded Adapter shall be either NPT or Metric thread forms. G1/2 and PG 13.5 thread forms are only acceptable for existing (legacy) equipment installations.

8 Rosemount 2088 and 2090 Declaration of Conformity

EU Declaration of Conformity

No: RMD 1010 Rev. N

We,

Rosemount, Inc.
8200 Market Boulevard
Chanassen, MN 55317-9685
USA

declare under our sole responsibility that the product,

Rosemount Pressure Transmitters 3051P, 2051G, 2088, and 2090

manufactured by,

Rosemount, Inc.
8200 Market Boulevard
Chanassen, MN 55317-9685
USA

to which this declaration relates, is in conformity with the provisions of the European Union Directives, including the latest amendments, as shown in the attached schedule.

Assumption of conformity is based on the application of the harmonized standards and, when applicable or required, a European Union notified body certification, as shown in the attached schedule.



(signature)

Chris LaPoint
(name)

Vice President of Global Quality

(function)

1-Feb-19; Shakopee, MN USA (date of issue)

Page 1 of 3



EU Declaration of Conformity

No: RMD 1010 Rev. N

EMC Directive (2014/30/EU)

Harmonized Standards: EN 61326-1:2013, EN 61326-2-3:2013

RoHS Directive (2011/65/EU)

Model 2090F Pressure Transmitter

Harmonized Standard: EN 50581:2012

ATEX Directive (2014/34/EU)

BAS00ATEX1166X - Intrinsic Safety Certificate

Equipment Group II Category 1 G

Ex ia IIC T4 Ga

Harmonized Standards:

EN60079-0:2012 + A11:2013, EN60079-11:2012

BAS00ATEX3167X - Type n Certificate

Equipment Group II Category 3 G

Ex nA IIC T5 Gc

Harmonized Standards:

EN60079-0:2012 + A11:2013, EN60079-15:2010

BAS01ATEX1427X - Dust Certificate

Equipment Group II Category 1 D

Ex t IIC T50°C T300/60°C Da

Harmonized Standards:

EN60079-0:2012 + A11:2013

Other Standards:

EN60079-31:2009

(A review against EN60079-31:2014 which is harmonized, shows no significant changes relevant to this equipment so EN60079-31:2009 continues to represent "State of the Art".)

KEMA97ATEX2378X - Flameproof Certificate

Equipment Group II Category 1/2 G

Ex db IIC T6...T4 Ga/Gb

Harmonized Standards:

EN 60079-0:2012 + A11:2013; EN60079-1:2014; EN60079-26:2015



EU Declaration of Conformity

No: RMD 1010 Rev. N

ATEX Notified Bodies

DEKRA (KEMA) [Notified Body Number: 0344]
Utrechtseweg 310, 6812 AR Arnhem
P.O. Box 5185, 6802 ED Arnhem
The Netherlands
Postbank 6794687

SGS FIMCO OY [Notified Body Number: 0598]
P.O. Box 30 (Särkiniementie 3)
00211 HELSINKI
Finland

ATEX Notified Body for Quality Assurance

SGS FIMCO OY [Notified Body Number: 0598]
P.O. Box 30 (Särkiniementie 3)
00211 HELSINKI
Finland

含有China RoHS管控物质超过最大浓度限值的部件型号列表 Rosemount 2088, 2090F, and 2090
List of Rosemount 2088, 2090F, and 2090 Parts with China RoHS Concentration above MCVs

部件名称 Part Name	有害物质 / Hazardous Substances					
	铅 Lead (Pb)	汞 Mercury (Hg)	镉 Cadmium (Cd)	六价铬 Hexavalent Chromium (Cr +6)	多溴联苯 Polybrominated biphenyls (PBB)	多溴联苯醚 Polybrominated diphenyl ethers (PBDE)
电子组件 Electronics Assembly	X	O	O	O	O	O
壳体组件 Housing Assembly	X	O	O	X	O	O
传感器组件 Sensor Assembly	X	O	O	X	O	O

本表格系依据SJ/T11364的规定而制作。

This table is proposed in accordance with the provision of SJ/T11364.

O: 意为该部件的所有均质材料中该有害物质的含量均低于GB/T 26572所规定的限量要求。



O: Indicate that said hazardous substance in all of the homogeneous materials for this part is below the limit requirement of GB/T 26572.

X: 意为在该部件所使用的所有均质材料里，至少有一类均质材料中该有害物质的含量高于GB/T 26572所规定的限量要求。

X: Indicate that said hazardous substance contained in at least one of the homogeneous materials used for this part is above the limit requirement of GB/T 26572.





Global Headquarters

Emerson Automation Solutions
6021 Innovation Blvd.
Shakopee, MN 55379, USA
 +1 800 999 9307 or +1 952 906 8888
 +1 952 949 7001
 RFQ.RMD-RCC@Emerson.com

Latin America Regional Office

Emerson Automation Solutions
1300 Concord Terrace, Suite 400
Sunrise, FL 33323, USA
 +1 954 846 5030
 +1 954 846 5121
 RFQ.RMD-RCC@Emerson.com

Asia Pacific Regional Office

Emerson Automation Solutions
1 Pandan Crescent
Singapore 128461
 +65 6777 8211
 +65 6777 0947
 Enquiries@AP.Emerson.com

 [Linkedin.com/company/Emerson-Automation-Solutions](https://www.linkedin.com/company/Emerson-Automation-Solutions)

 [Twitter.com/Rosemount_News](https://twitter.com/Rosemount_News)

 [Facebook.com/Rosemount](https://www.facebook.com/Rosemount)

 [Youtube.com/user/RosemountMeasurement](https://www.youtube.com/user/RosemountMeasurement)

 [Google.com/+RosemountMeasurement](https://www.google.com/+RosemountMeasurement)

North America Regional Office

Emerson Automation Solutions
8200 Market Blvd.
Chanhassen, MN 55317, USA
 +1 800 999 9307 or +1 952 906 8888
 +1 952 949 7001
 RMT-NA.RCCRF@Emerson.com

Europe Regional Office

Emerson Automation Solutions Europe GmbH
Neuhofstrasse 19a P.O. Box 1046
CH 6340 Baar
Switzerland
 +41 (0) 41 768 6111
 +41 (0) 41 768 6300
 RFQ.RMD-RCC@Emerson.com

Middle East and Africa Regional Office

Emerson Automation Solutions
Emerson FZE P.O. Box 17033
Jebel Ali Free Zone - South 2
Dubai, United Arab Emirates
 +971 4 8118100
 +971 4 8865465
 RFQ.RMTMEA@Emerson.com

©2019 Emerson. All rights reserved.

Emerson Terms and Conditions of Sale are available upon request. The Emerson logo is a trademark and service mark of Emerson Electric Co. Rosemount is mark of one of the Emerson family of companies. All other marks are the property of their respective owners.