

Rosemount™ 3144P Temperature Transmitter

With HART® Protocol and Rosemount X-well™ Technology



Contents

About this guide.....	3
System readiness.....	5
Verify configuration.....	6
Set the switches.....	10
Mount the transmitter.....	11
Wire and apply power.....	14
Perform a loop test.....	19
Safety Instrumented Systems (SIS).....	20
Product certifications.....	21

1 About this guide

This guide provides basic guidelines for installing the Rosemount 3144P Transmitter. It does not provide instructions for detailed configuration, diagnostics, maintenance, service, troubleshooting, Explosion-proof, Flameproof, or Intrinsically Safe (I.S.) installations. Refer to the Rosemount 3144P Transmitter [Reference Manual](#) for more instructions. The manual and this guide are also available electronically on [Emerson.com/Rosemount](https://www.emerson.com/Rosemount).

⚠ WARNING

Explosions

Explosions could result in death or serious injury.

Installation of device in an explosive environment must be in accordance with appropriate local, national, and international standards, codes, and practices.

Review the Product Certifications section of this document for any restrictions associated with a safe installation.

Process leaks

Process leaks may cause harm or result in death.

Before applying pressure, install and tighten thermowells and sensors.

Do not remove the thermowell while in operation.

Conduit/cable entries

The conduit/cable entries in the transmitter housing use a ½–14 NPT thread form.

When installing in a hazardous location, use only appropriately listed or Ex certified plugs, glands, or adapters in cable/conduit entries.

Electrical shock

Electrical shock can result in death or serious injury.

Avoid contact with the leads and terminals. High voltage that may be present on leads could cause electrical shock.

⚠ WARNING**Physical access**

Unauthorized personnel may potentially cause significant damage to and/or misconfiguration of end users' equipment. This could be intentional or unintentional and needs to be protected against.

Physical security is an important part of any security program and fundamental in protecting your system. Restrict physical access by unauthorized personnel to protect end users' assets. This is true for all systems used within the facility.

2 System readiness

2.1 Confirm HART® revision capability

If using HART-based control or asset management systems, confirm the HART capability of those systems prior to transmitter installation. Not all systems are capable of communicating with HART Revision 7 Protocol. You can configure the transmitter for either HART Revision 5 or 7.

For instructions on how to change the HART revision of your transmitter, refer to [Switch HART revision mode](#).

3 Verify configuration

The Rosemount 3144P Transmitter communicates using a Field Communicator (communication requires a loop resistance between 250 and 1100 ohms) or AMS Device Manager.

Do not operate when power is below 12 Vdc at the transmitter terminal. Refer to the [Rosemount 3144P Transmitter Reference Manual](#) and [Field Communicator Reference Manual](#).

3.1 Update the Field Communicator software

To fully communicate with the Rosemount 3144P Transmitter, you need the latest Field Communicator Field Device Revision Dev v5 or v7, DD v1 or greater. Transmitters equipped with Rosemount X-well Technology require DD revision 3144P Dev. 7 Rev. 1 or greater to view this functionality.

The Device Descriptors are available with new communicators at [Emerson.com/Rosemount](https://emerson.com/Rosemount), or you can download them into existing communicators at any Emerson Service Center.

The device descriptors are as follows:

- Device in HART 5 mode: Device v5 DDv1
- Device in HART 7 mode: Device v7 DDv1

To determine if you need to upgrade your device:

Figure 3-1: Connecting a Field Communicator to a bench loop

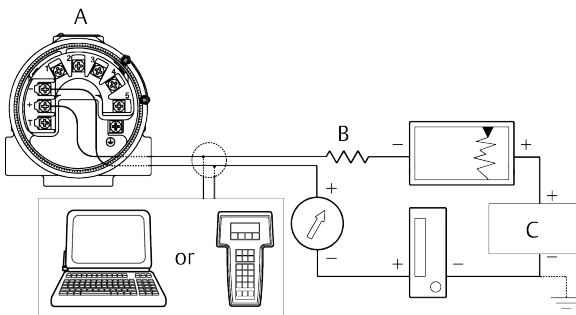

- A. Power/signal terminals
 B. $250 \Omega \leq R_L \leq 1100 \Omega$
 C. Power supply

Procedure

1. Connect the sensor.

See the wiring diagram located on the inside of the housing cover.

2. Connect the bench power supply to the power terminals ("+" or "-").
3. Connect a Field Communicator to the loop across a loop resistor or at the power/signal terminals on the transmitter.

The following message will appear if the communicator has a previous version of the Device Descriptors (DDs):

NOTICE

Upgrade the communicator software to access new XMTR functions. Continue with old description.

Note

If this notice does not appear, the latest DD is installed.

If the latest version is not available, the communicator will communicate properly, but when the transmitter is configured some new capabilities may not be visible.

To prevent this from happening, upgrade to the latest DD or answer **NO** to the question and default to the generic transmitter functionality.

3.2 Switch HART revision mode

If the HART Protocol configuration tool is not capable of communicating with HART Revision 7, the transmitter will load a generic menu with limited capability. The following procedure will switch the HART Revision mode from the generic menu.

Procedure

Select **Manual Setup** → **Device Information** → **Identification** → **Message**.

- To change to HART Revision 5, enter **HART5** in the **Message** field.
- To change to HART Revision 7, enter **HART7** in the **Message** field.

Function	HART 5 Fast Keys	HART 7 Fast Keys
2-wire offset sensor 1	2, 2, 1, 5	2, 2, 1, 6
2-wire offset sensor 2	2, 2, 2, 5	2, 2, 2, 6
Alarm values	2, 2, 5, 6	2, 2, 5, 6
Analog calibration	3, 4, 5	3, 4, 5

Function	HART 5 Fast Keys	HART 7 Fast Keys
Analog output	2, 2, 5	2, 2, 5
Average temperature setup	2, 2, 3, 3	2, 2, 3, 3
Burst mode	N/A	2, 2, 8, 4
Comm status	N/A	1, 2
Configure additional messages	N/A	2, 2, 8, 7
Configure Hot Backup™	2, 2, 4, 1, 3	2, 2, 4, 1, 3
Date	2, 2, 7, 1, 2	2, 2, 7, 1, 3
Descriptor	2, 2, 7, 1, 3	2, 2, 7, 1, 4
Device information	2, 2, 7, 1	2, 2, 7, 1
Differential temperature setup	2, 2, 3, 1	2, 2, 3, 1
Filter 50/60 Hz	2, 2, 7, 5, 1	2, 2, 7, 5, 1
Find device	N/A	3, 4, 6, 2
First good temperature setup	2, 2, 3, 2	2, 2, 3, 2
Hardware revision	1, 8, 2, 3	1, 11, 2, 3
HART lock	N/A	2, 2, 9, 2
Intermittent sensor detect	2, 2, 7, 5, 2	2, 2, 7, 5, 2
Lock status	N/A	1, 11, 3, 7
Long tag	N/A	2, 2, 7, 2
Loop test	3, 5, 1	3, 5, 1
LRV (lower range value)	2, 2, 5, 5, 3	2, 2, 5, 5, 3
Message	2, 2, 7, 1, 4	2, 2, 7, 1, 5
Min/max tracking	2, 1, 7, 2	2, 1, 7, 2
Open sensor holdoff	2, 2, 7, 4	2, 2, 7, 4
Percent range	2, 2, 5, 4	2, 2, 5, 4
Rosemount X-well configuration	N/A	2, 2, 1, 11
Sensor 1 configuration	2, 2, 1	2, 2, 1
Sensor 1 serial number	2, 2, 1, 7	2, 2, 1, 8
Sensor 1 setup	2, 2, 1	2, 2, 2
Sensor 1 status	N/A	2, 2, 1, 2
Sensor 1 type	2, 2, 1, 2	2, 2, 1, 3

Function	HART 5 Fast Keys	HART 7 Fast Keys
Sensor 1 unit	2, 2, 1, 4	2, 2, 1, 5
Sensor 2 configuration	2, 2, 2	2, 2, 2
Sensor 2 serial number	2, 2, 2, 7	2, 2, 2, 8
Sensor 2 setup	2, 2, 2	2, 2, 2
Sensor 2 status	N/A	2, 2, 2, 2
Sensor 2 type	2, 2, 2, 2	2, 2, 2, 3
Sensor 2 unit	2, 2, 2, 4	2, 2, 2, 5
Sensor drift alert	2, 2, 4, 2	2, 2, 4, 2
Simulate device variables	N/A	3, 5, 2
Software revision	1, 8, 2, 4	1, 11, 2, 4
Tag	2, 2, 7, 1, 1	2, 2, 7, 1, 1
Terminal temperature units	2, 2, 7, 3	2, 2, 7, 3
Thermocouple diagnostic	2, 1, 7, 1	2, 1, 7, 2
URV (upper range value)	2, 2, 7, 3	2, 2, 7, 3
Variable mapping	2, 2, 8, 5	2, 2, 8, 5

4 Set the switches

The Rosemount 3144P Transmitter comes with hardware switches to configure alarms and lock the device.

⚠ WARNING

Enclosure covers must be fully engaged to meet explosion-proof requirements.

4.1 Set the switches with an LCD display

Procedure

1. Set the loop to manual (if applicable) and disconnect the power.
2. Remove the electronics housing cover.
3. Unscrew the LCD display screws and gently slide the meter straight off.
4. Set the alarm and security switches to the desired position.
5. Gently slide the LCD display back into place.
6. Replace and tighten the LCD display screws to secure the LCD display.
7. Reattach housing cover.
8. Apply power and set the loop to automatic control.

4.2 Set the switches without an LCD display

Procedure

1. Set the loop to manual (if applicable) and disconnect the power.
2. Remove the electronics housing cover.
3. Set the alarm and security switches to the desired position.
4. Reattach housing cover.
5. Apply power and set the loop to automatic control.

5 Mount the transmitter

Mount the transmitter at a high point in the conduit run to prevent moisture from draining into the transmitter housing.

5.1 Typical North American installation

Procedure

1. Mount the thermowell to the process container wall.
2. Install and tighten thermowells.
3. Perform a leak check.
4. Attach any necessary unions, couplings, and extension fittings. Seal the fitting threads with an approved thread sealant, such as silicone or PTFE tape (if required).
5. Screw the sensor into the thermowell or directly into the process (depending on installation requirements).
6. Verify all sealing requirements.
7. Attach the transmitter to the thermowell/sensor assembly. Seal all threads with an approved thread sealant, such as silicone or PTFE tape (if required).
8. Install field wiring conduit into the open transmitter conduit entry (for remote-mounting) and feed wires into the transmitter housing.
9. Pull the field wiring leads into the terminal side of the housing.
10. Attach the sensor leads to the transmitter sensor terminals. The wiring diagram is located inside the housing cover.
11. Attach and tighten both transmitter covers.

5.2 Typical European installation

Procedure

1. Mount the thermowell to the process container wall.
2. Install and tighten thermowells.
3. Perform a leak check.
4. Attach a connection head to the thermowell.
5. Insert sensor into the thermowell and wire the sensor to the connection head. The wiring diagram is located inside the connection head.

6. Mount the transmitter to a 2-in. (50 mm) pipe or a panel using one of the optional mounting brackets.
7. Attach cable glands to the shielded cable running from the connection head to the transmitter conduit entry.
8. Run the shielded cable from the opposite conduit entry on the transmitter back to the control room.
9. Insert shielded cable leads through the cable entries into the connection head/transmitter. Connect and tighten cable glands.
10. Connect the shielded cable leads to the connection head terminals (located inside the connection head) and to the sensor wiring terminals (located inside the transmitter housing).

5.3 Install Rosemount X-well Technology

Rosemount X-well Technology is for temperature monitoring applications and is not intended for control or safety applications. It is available in the Rosemount 3144P Temperature Transmitter in a factory assembled direct mount configuration with a Rosemount 0085 Pipe Clamp Sensor. It cannot be used in a remote mount configuration.

NOTICE

Rosemount X-well Technology will only work as specified with factory supplied and assembled Rosemount 0085 Pipe Clamp silver tipped single element sensor with a 3.2-in. (80 mm) extension length. It will not work as specified if used with other sensors. Installing and using the incorrect sensor will result in inaccurate process temperature calculations.

Important

Follow the above requirements and installation best practices below to ensure that Rosemount X-well Technology works as specified.

Follow pipe clamp sensor installation best practices. See [Rosemount 0085 Pipe Clamp Sensor Quick Start Guide](#) with Rosemount X-well Technology specific requirements noted below:

Procedure

1. Mount the transmitter directly on a pipe clamp sensor.
2. Install the transmitter away from dynamic external temperature sources, such as a boiler or heat tracing.

NOTICE

Inaccurate calculations

Moisture build-up between the sensor and pipe surface or sensor hang-up in assembly can cause inaccurate process temperature calculations.

Ensure the pipe clamp sensor tip makes direct contact with the pipe surface.

Refer to installation best practices in [Rosemount 0085 Pipe Clamp Sensor Quick Start Guide](#) to ensure proper sensor to pipe surface contact.

3. To prevent heat loss, insulate the sensor clamp assembly and sensor extension up to the transmitter head (½-in. thick minimum with an R-value of $> 0.42 \text{ m}^2 \times \text{K/W}$). Apply a minimum of 6-in. (152.4 mm) of insulation on each side of the pipe clamp sensor.

Take care to minimize air gaps between insulation and pipe. See [Figure 5-1](#).

Figure 5-1: Transmitter with Rosemount X-well Technology installation

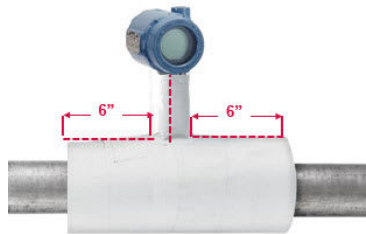

NOTICE

Over-insulation

Insulating the transmitter head may result in longer response times and may damage the transmitter electronics.

Do not apply insulation over the transmitter head.

4. Although it will be configured that way at the factory, ensure that the pipe clamp RTD sensor is assembled in four-wire configuration.

6 Wire and apply power

6.1 Wire the transmitter

Wiring diagrams are located inside the terminal block cover.

Table 6-1: Single sensor

2-wire RTD and ohms	3-wire RTD and ohms ⁽¹⁾	4-wire RTD and ohms	Thermocouples and mV	RTD with compensation loop ⁽²⁾

- (1) Emerson provides four-wire sensors for all single-element RTDs. You can use these RTDs in three-wire configurations by leaving the unneeded leads disconnected and insulated with electrical tape.
- (2) Transmitter must be configured for a three-wire RTD in order to recognize an RTD with a compensation loop.

Table 6-2: Dual sensor

Emerson provides four-wire sensors for all single-element RTDs. To use these RTDs in three-wire configurations, leave the unneeded leads disconnected and insulated with electrical tape. This table refers to wiring dual sensors for ΔT and Hot Backup™.

With 2 RTDs	With 2 thermocouples	With RTDs/ thermocouples	With RTDs/ thermocouples	With 2 RTDs with compensation loop

6.2 Power the transmitter

An external power supply is required to operate the transmitter.

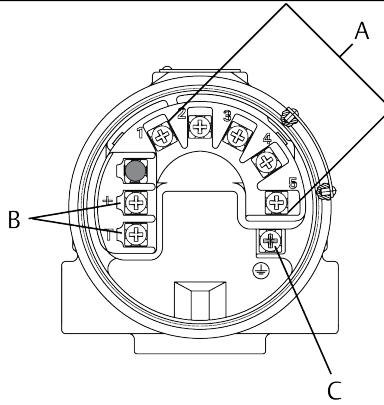

- A. Sensor terminals (1-5)
- B. Power terminals
- C. Ground

Procedure

1. Remove the terminal block cover.
2. Connect the positive power lead to the "+" terminal.
3. Connect the negative power lead to the "-" terminal.
4. Tighten the terminal screws.
5. Reattach and tighten the cover.

⚠ WARNING

Enclosure

Enclosure covers must be fully engaged to meet explosion-proof requirements.

6. Apply power.

6.3 Load limitations

The power required across the transmitter power terminals is 12 to 42 Vdc (power terminals are not rated to 42.4 Vdc).

NOTICE

To prevent the possibility of damaging the transmitter, do not allow terminal voltage to drop below 12.0 Vdc when changing the configuration parameters.

Figure 6-1: Load limitation

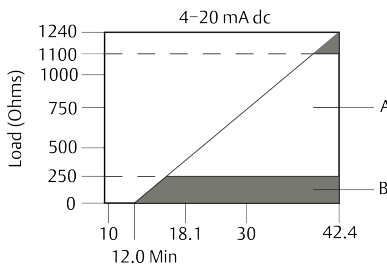

Maximum load = $40.8 \times (\text{supply voltage} - 12.0)$ without transient protection (optional).

- A. HART and analog operating range
- B. Analog only operating range

6.4 Ground the transmitter

6.4.1 Ungrounded thermocouple, mV, and RTD/ohm inputs

Each process installation has different requirements for grounding. Use the grounding options recommended by the facility for the specific sensor type or begin with grounding option 1 (the most common).

Ground the transmitter: option 1

Emerson recommends this option for ungrounded transmitter housing.

Procedure

1. Connect signal wiring shield to the sensor wiring shield.
2. Ensure the two shields are tied together and electrically isolated from the transmitter housing.
3. Ground shield at the power supply end only.

4. Ensure that the sensor shield is electrically isolated from the surrounding grounded fixtures.

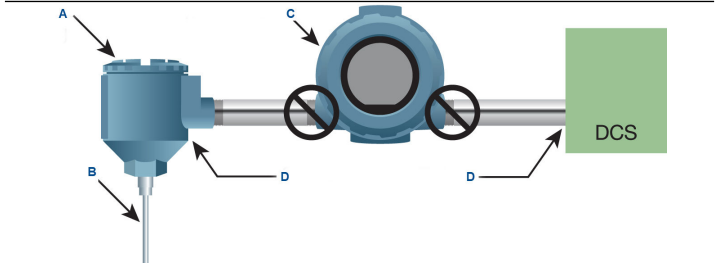

- A. Remote sensor housing
- B. Sensor
- C. Transmitter
- D. Shield ground points

Ground the transmitter: option 2

Emerson recommends this method for grounded transmitter housing.

Procedure

1. Connect sensor wiring shield to the transmitter housing. Do this only if the housing is grounded.
2. Ensure that the sensor is electrically isolated from surrounding fixtures that may be grounded.
3. Ground signal wiring shield at the power supply end.

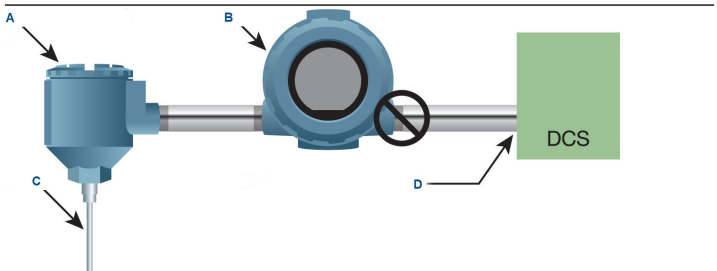

- A. Remote sensor housing
- B. Transmitter
- C. Sensor
- D. Shield ground parts

Ground the transmitter: option 3

Procedure

1. Ground sensor wiring shield at the sensor, if possible.
2. Ensure the sensor wiring and signal wiring shields are electrically isolated from the transmitter housing and other grounded fixtures.
3. Ground signal wiring shield at the power supply end.

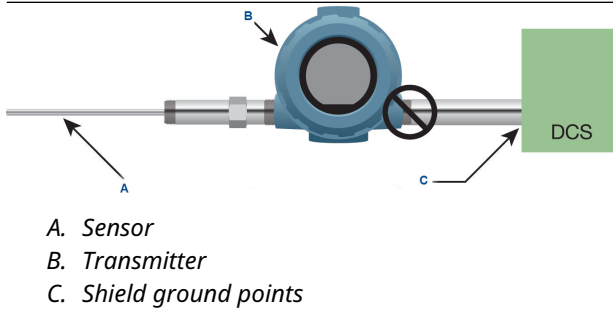

6.4.2 Ground thermocouple inputs

Procedure

1. Ground sensor wiring shield at the sensor.
2. Ensure the sensor wiring and signal wiring shields are electrically isolated from the transmitter housing and other grounded fixtures.
3. Ground signal wiring shield at the power supply end.

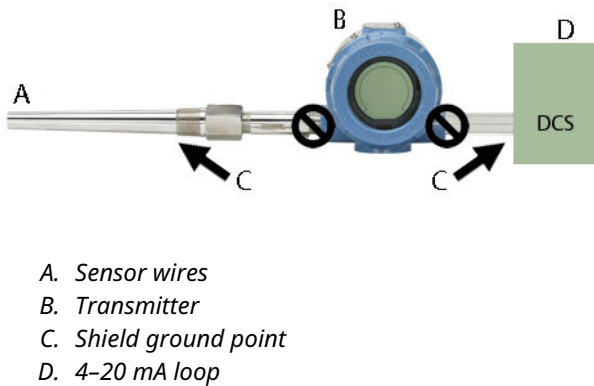

7 Perform a loop test

The loop test verifies transmitter output, loop integrity, and operation of any recorders or similar devices installed in the loop.

The following procedures are for the device dashboard - device revisions 5 and 7, DD v1.

7.1 Initiate a loop test

Procedure

1. Connect an external ampere meter in series with the transmitter loop (so the power to the transmitter goes through the meter at some point in the loop).
2. From the **Home** screen, select **3 Service Tools** → **5 Simulate** → **1 Perform Loop Test**.
The communicator displays the loop test menu.
3. Select a discrete milliampere level for the transmitter to output.
 - a) At **Choose Analog Output**, select **1 4 mA** or **2 20 mA**. If you want to enter a different value, select **4 Other** to manually input a value between 4 and 20 milliamperes.
 - b) Select **Enter** to show the fixed output.
 - c) Select **OK**.
4. In the test loop, check that the transmitter's actual mA output and the HART mA reading are the same value.
If the readings do not match, either the transmitter requires an output trim or the current meter is malfunctioning.
After completing the test, the display returns to the loop test screen where you can choose another output value.
5. To end the loop test, select **5 End** and **Enter**.

7.2 Initiate simulation alarm

Procedure

1. From the **Home** screen, select **3 Service Tools** → **5 Simulate** → **1 Perform Loop Test** → **3 Simulate Alarm**.
The transmitter will output the alarm current level based on the configured alarm parameter and switch settings.
2. Select **5 End** to return the transmitter to normal conditions.

8 Safety Instrumented Systems (SIS)

For safety certified installations, refer to the [Rosemount 3144P Reference Manual](#). The manual is available electronically on [Emerson.com/Rosemount](https://www.emerson.com/Rosemount). You can also contact an Emerson representative for the manual.

9 Product certifications

Rev 2.25

9.1 European Directive information

A copy of the EU Declaration of Conformity can be found at the end of the Quick Start Guide. The most recent revision of the EU Declaration of Conformity can be found at [Emerson.com/global](https://www.emerson.com/global).

9.2 Ordinary location certification

As standard, the transmitter has been examined and tested to determine that the design meets the basic electrical, mechanical, and fire protection requirements by a Nationally Recognized Test Laboratory (NRTL), as accredited by the Federal Occupational Safety and Health Administration (OSHA).

9.3 North America

9.3.1 E5 USA Explosionproof, Dust-Ignition proof, and Nonincendive

Certificate FM16US0202X

Standards FM Class 3600: 2011, FM Class 3611: 2004, FM Class 3615: 2006, FM Class 3810: 2005, ANSI/NEMA 250: 1991, ANSI/ISA 60079-0: 2009, ANSI/ISA 60079-11: 2009

Markings **XP** CL I, DIV 1, GP A, B, C, D; T5(-50 °C ≤ T_a ≤ +85 °C);

DIP CL II/III, DIV 1, GP E, F, G; T5(-50 °C ≤ T_a ≤ +75 °C); T6(-50 °C ≤ T_a ≤ +60 °C); when installed per Rosemount drawing 03144-0320;

NI CL I, DIV 2, GP A, B, C, D; T5(-60 °C ≤ T_a ≤ +75 °C); T6(-60 °C ≤ T_a ≤ +60 °C); when installed per Rosemount drawing 03144-0321, 03144-5075.

9.3.2 I5 USA Intrinsic Safety and Nonincendive

Certificate FM16US0202X [HART]

Standards FM Class 3600: 2011, FM Class 3610: 2010, FM Class 3611: 2004, FM Class 3810: 2005, ANSI/NEMA 250: 1991, ANSI/ISA 60079-0: 2009, ANSI/ISA 60079-11: 2009

Markings **IS** CL I/II/III, DIV 1, GP A, B, C, D, E, F, G; T4(-60 °C ≤ T_a ≤ +60 °C);

IS [Entity] CL I, Zone 0, AEx ia IIC T4(-60 °C ≤ T_a ≤ +60 °C);

NI CL I, DIV 2, GP A, B, C, D; T5(-60 °C ≤ T_a ≤ +85 °C); T6(-60 °C ≤ T_a ≤ +60 °C); when installed per Rosemount drawing 03144-5076.

9.3.3 I6 Canada Intrinsic Safety and Division 2

Certificate 1242650

Standards CSA Std C22.2 No. 25-17, CAN/CSA-C22.2 No. 94.2:20, CSA Std C22.2 No. 213-17, CAN/CSA-C22.2 No. 60079-0: 2019, CAN/CSA-C22.2 No. 60079-11: 2014, CAN/CSA-C22.2 No. 61010-1-12, UPD1: 2015, UPD2: 2016;

Markings Intrinsically Safe for Class I Groups A, B, C, D; Class II, Groups E, F, G; Class III;
IS [Entity] Ex ia IIC T4, Ex ia IIIC T94C T4(-60 °C ≤ T_a ≤ +60 °C);
 [HART only zone markings]: Intrinsically Safe for Class I Zone 0 Group IIC; T4(-50 °C ≤ T_a ≤ +60 °C); Type 4X;
 Suitable for Class I, Div. 2, Groups A, B, C, D;
 [HART only zone markings]: Suitable for Class I Zone 2 Group IIC; T6(-60 °C ≤ T_a ≤ +60 °C); T5(-60 °C ≤ T_a ≤ +85 °C); when installed per Rosemount drawing 03144-5076.

9.3.4 K6 Canada Explosionproof, Intrinsic Safety and Division 2

Certificate 1242650

Standards CAN/CSA C22.2 No. 0-M91 (R2001), CSA Std C22.2 No. 25-1966, CSA Std C22.2 No. 30-M1986; CAN/CSA-C22.2 No. 94-M91, CSA Std C22.2 No. 142-M1987, CAN/CSA-C22.2 No. 157-92, CSA Std C22.2 No. 213-M1987;

Markings Explosionproof for Class I, Groups A, B, C, D; Class II, Groups E, F, G; Class III;
 [HART only zone markings]: Suitable for Class I, Zone 1, Group IIC; Intrinsically Safe for Class I, Groups A, B, C, D; Class II, Groups E, F, G; Class III;
 [HART only zone markings]: Suitable for Class I, Zone 0, Group IIC; T4(-50 °C ≤ T_a ≤ +60 °C); Type 4X; Suitable for Class I, Div. 2, Groups A, B, C, D;
 [HART only zone markings]: Suitable for Class I, Zone 2, Group IIC; T6(-60 °C ≤ T_a ≤ +60 °C); T5(-60 °C ≤ T_a ≤ +85 °C); when installed per Rosemount drawing 03144-5076.

9.4 Europe

9.4.1 E1 ATEX Flameproof

Certificate DEKRA 19ATEX0076 X

Standards EN IEC 60079-0: 2018, EN 60079-1: 2014

Markings  II 2 G Ex db IIC T6...T1 Gb, T6(-60 °C ≤ T_a ≤ +70 °C), T5...T1(-60 °C ≤ T_a ≤ +80 °C)

Specific Conditions of Use (X):

1. Flameproof joints are not intended for repair.
2. Non-standard paint options may cause risk from electrostatic discharge. Avoid installations that cause electrostatic build-up on painted surfaces and only clean the painted surfaces with a damp cloth. If paint is ordered through a special option code, contact the manufacturer for more information.

Additional Specific Conditions of Use (X) when “XA” designation is ordered:

Guard DIN style sensors against impacts greater than 4J.

Process temperature range at sensor connection ⁽¹⁾ (°C).	Ambient temperature range (°C)	Temperature class
-60 °C to +70 °C	-60 °C to +70 °C	T6
-60 °C to +80 °C	-60 °C to +80 °C	T5...T1

(1) Sensor connection is where the sensor threads into the transmitter or junction box housing

9.4.2 I1 ATEX Intrinsic Safety

Certificate BAS01ATEX1431X [HART]; Baseefa03ATEX0708X [Fieldbus]

Standards EN IEC 60079-0: 2018; EN 60079-11:2012

Markings HART:  II 1 G Ex ia IIC T5/T6 Ga; T6(-60 °C ≤ T_a ≤ +50 °C), T5(-60 °C ≤ T_a ≤ +75 °C)

Fieldbus:  II 1 G Ex ia IIC T4 Ga; T4(-60 °C ≤ T_a ≤ +60 °C)

See [Table 9-7](#) for entity parameters.



Special Conditions for Safe Use (X):

1. When fitted with the transient terminal options, the equipment is not capable of passing the 500 V insulation test. This must be taken into account during installation.
2. The enclosure may be made from aluminum alloy with a protective polyurethane paint finish; however, care should be taken to protect it from impact or abrasion when located in Zone 0.

9.4.3 N1 ATEX Type n

Certificate BAS01ATEX3432X [HART]; Baseefa03ATEX0709X [Fieldbus]

Standards EN IEC 60079-0:2018, EN 60079-15:2010

Markings HART:  II 3 G Ex nA IIC T5/T6 Gc; T6(-40 °C ≤ T_a ≤ +50 °C), T5(-40 °C ≤ T_a ≤ +75 °C);
Fieldbus:  II 3 G Ex nA IIC T5 Gc; T5(-40 °C ≤ T_a ≤ +75 °C);

Special Condition for Safe Use (X):

When fitted with the transient terminal options, the equipment is not capable of withstanding the 500 V electrical strength test as defined in clause 6.5.1 of EN 60079-15: 2010. This must be taken into account during installation.

9.4.4 ND ATEX Dust

Certificate DEKRA 19ATEX0076 X

Standards EN IEC 60079-0:2018, EN 60079-31:2014

Markings  II 2 D Ex tb IIIC T130 °C Db, (-60 °C ≤ T_a ≤ +80 °C)

Specific Condition of Use (X):

Non-standard paint options may cause risk from electrostatic discharge. Avoid installations that cause electrostatic build-up on painted surfaces and only clean the painted surfaces with a damp cloth. If paint is ordered through a special option code, contact the manufacturer for more information.

Additional Specific Condition of Use (X) when “XA” designation is ordered:

The spring loaded adapter style sensors and DIN style sensors must be installed in a thermowell to maintain Ex tb protection.

Process temperature range at sensor connection ⁽¹⁾ (°C).	Ambient temperature range (°C)	Maximum surface temperature "T"
-60 °C to +80 °C	-60 °C to +80 °C	T130 °C

(1) *Sensor connection is where the sensor threads into the transmitter or junction box housing*

9.5 International

9.5.1 E7 IECEx Flameproof

Certificate IECEx DEK 19.0041X

Standards IEC 60079-0:2017, IEC 60079-1:2014

Markings Ex db IIC T6...T1 Gb, T6(-60 °C ≤ T_a ≤ +70 °C), T5...T1(-60 °C ≤ T_a ≤ +80 °C);

Specific Conditions of Use (X):

1. Flameproof joints are not intended for repair.
2. Non-Standard Paint options may cause risk from electrostatic discharge. Avoid installations that cause electrostatic build-up on painted surfaces, and only clean the painted surfaces with a damp cloth. If paint is ordered through a special option code, contact the manufacturer for more information.

Additional Specific Condition of Use (X) when "XA" designation is ordered:

Guard DIN Style sensors against impacts greater than 4J.

Process temperature range at Sensor Connection ⁽¹⁾ (°C)	Ambient temperature range (°C)	Temperature class
-60 °C to +70 °C	-60 °C to +70 °C	T6
-60 °C to +80 °C	-60 °C to +80 °C	T5...T1

(1) *Sensor Connection is where the sensor threads into the transmitter or junction box housing.*

Additionally Available with Option K7:

IECEx Dust

Certificate IECEx DEK 19.0041X

Standards IEC 60079-0:2017 and IEC 60079-31:2013

Markings Ex tb IIIC T130 °C Db, (-60 °C ≤ T_a ≤ +80 °C);

Specific Conditions of Use (X):

Non-Standard Paint options may cause risk from electrostatic discharge. Avoid installations that cause electrostatic build-up on painted surfaces, and only clean the painted surfaces with a damp cloth. If paint is ordered through a special option code, contact the manufacturer for more information.

Additional Specific Conditions of Use (X) when “XA” designation is ordered:

The spring loaded adapter style sensors and DIN style sensors must be installed in a thermowell to maintain Ex tb protection.

Process temperature range at Sensor Connection ⁽¹⁾ (°C)	Ambient Temperature Range (°C)	Maximum surface temperature “T”
-60 °C to +80 °C	-60 °C to +80 °C	T130 °C

(1) *Sensor Connection is where the sensor threads into the transmitter or junction box housing.*

9.5.2 I7 IECEx Intrinsic Safety

Certificate IECEx BAS 07.0002X [HART]; IECEx BAS 07.0004X [Fieldbus]

Standards IEC 60079-0: 2017; IEC 60079-11: 2011

Markings HART: Ex ia IIC T5/T6 Ga; T6(-60 °C ≤ T_a ≤ +50 °C), T5(-60 °C ≤ T_a ≤ +75 °C);
Fieldbus: Ex ia IIC T4 Ga; T4(-60 °C ≤ T_a ≤ +60 °C)
See [Table 9-7](#) for entity parameters.

Special Conditions for Safe Use (X):

1. When fitted with the transient terminal options, the apparatus is not capable of withstanding the 500 V electrical strength test as defined in Clause 6.3.13 of IEC 60079-11: 2011. This must be taken into account during installation.
2. The enclosure may be made from aluminum alloy with a protective polyurethane paint finish; however, care should be taken to protect it from impact or abrasion when located in Zone 0.

9.5.3 N7 IECEx Type n

Certificate IECEx BAS 07.0003X [HART]; IECEx BAS 07.0005X [Fieldbus]

Standards IEC 60079-0:2017, IEC 60079-15:2010

Markings HART: Ex nA IIC T5/T6 Gc; T6(-40 °C ≤ T_a ≤ +50 °C), T5(-40 °C ≤ T_a ≤ +75 °C);
Fieldbus: Ex nA IIC T5 Gc; T5(-40 °C ≤ T_a ≤ +75 °C);

Special Condition for Safe Use (X):

When fitted with the transient terminal options, the apparatus is not capable of withstanding the 500 V electrical strength test as defined in clause 6.5.1 of IEC 60079-15: 2010. This must be taken into account during installation.

9.6 Brazil

9.6.1 E2 Brazil Flameproof and Dust

Certificate UL-BR 21.1296X

Standards ABNT NBR IEC 60079-0:2020; ABNT NBR IEC 60079-1:2016; ABNT NBR IEC 60079-31:2014

Markings Ex db IIC T6...T1 Gb; T6 (-60 °C ≤ T_a ≤ +70 °C); T5...T1 (-60 °C ≤ T_a ≤ +80 °C)
Ex tb IIIC T130 °C Db; (-60 °C ≤ T_a ≤ +80 °C)

Special Conditions for Safe Use (X):

1. Flameproof joints are not intended for repair.
2. Non-standard paint options may cause risk of electrostatic discharge. Avoid installations that cause electrostatic build-up on painted surfaces and only clean the painted surfaces with a damp cloth. If paint is ordered through a special option code, contact the manufacturer for more information.

Additional Special Conditions for Safe Use (X) when "XA" designation is ordered:

1. Guard DIN Style sensors against impacts greater than 4J.
2. The spring loaded adapter style sensors and DIN style sensors must be installed in a thermowell to maintain Ex tb protection.

Process temperature range at sensor connection (°C) ⁽¹⁾	Ambient temperature range (°C)	Temperature class
-60 °C to +70 °C	-60 °C to +70 °C	T6
-60 °C to +80 °C	-60 °C to +80 °C	T5...T1
-60 °C to +80 °C	-60 °C to +80 °C	T130 °C

(1) *Sensor Connection is where the sensor threads into the transmitter or junction box housing.*

9.6.2 I2 Brazil Intrinsic Safety [HART]

Certificate UL-BR 15.0088X

Standards ABNT NBR IEC 60079-0:2013, ABNT NBR IEC 60079-11:2013

Markings Ex ia IIC T6 Ga (-60 °C < T_a < 50 °C), Ex ia IIC T5 Ga (-60 °C < T_a < 75 °C)
See [Table 9-7](#) for entity parameters.

Special Conditions for Safe Use (X):

1. When fitted with the transient terminal options, the equipment is not capable of withstanding the 500 V electrical strength test as defined in ABNT NBR IEC60079-11. This must be taken into account during installation.
2. The enclosure may be made from aluminum alloy with a protective polyurethane paint finish; however, care should be taken to protect it from impact and abrasion when located in areas that require EPL Ga (Zone 0).

Brazil Intrinsic Safety [Fieldbus/FISCO]

Certificate UL-BR 15.0030X

Standards ABNT NBR IEC 60079-0:2013, ABNT NBR IEC 60079-11:2013

Markings Ex ia IIC T4 Ga (-60 °C < T_a < +60 °C)
See [Table 9-7](#) at the end of the Product Certifications section for Entity Parameters

Special Conditions for Safe Use (X):

1. When mounted with the terminal options with transient protection, the equipment is not capable of withstanding the

dielectric strength test with 500 V as defined in ABNT NBR IEC 60079-11. This feature should be taken into account during installation.

- The enclosure may be made from aluminum alloy with a protective polyurethane paint finish; however, care should be taken to protect it from impact and abrasion when located in areas that require EPL Ga (Zone 0).

9.7 China

9.7.1 E3 China Flameproof

Certificate GYJ21.1277X

Standards GB/T 3836.1-2021, GB/T 3836.2-2021, GB/T 3836.31-2021

Markings Ex dB IIC T6...T1 Gb, Ex tb IIIC T130 °C Db

- 产品安全使用特殊条件

证书编号后缀“X”表明产品具有安全使用特殊条件：

- 涉及隔爆接合面的维修须联系产品制造商。
- 产品铭牌材质为非金属，使用时须防止产生静电火花，只能用湿布清理。
- XA 选项时必须配套管以保证实现粉尘防护型式。
- 产品温度组别和使用环境温度范围之间的关系为：

过程温度	环境温度	温度组别
$-60\text{ °C} \leq T_a \leq +70\text{ °C}$	$-60\text{ °C} \leq T_a \leq +70\text{ °C}$	T6
$-60\text{ °C} \leq T_a \leq +80\text{ °C}$	$-60\text{ °C} \leq T_a \leq +80\text{ °C}$	T5...T1
$-60\text{ °C} \leq T_a \leq +80\text{ °C}$	$-60\text{ °C} \leq T_a \leq +80\text{ °C}$	T130 °C

- 产品使用注意事项

- 产品外壳设有接地端子，用户在使用时应可靠接地。
- 安装现场应不存在对产品外壳有腐蚀作用的有害气体。
- 现场安装时，电缆引入口须选用国家指定的防爆检验机构按检验认可、具有 **Ex dbIIIC**、**Ex ta IIIC Da** 防爆等级的电缆引入装置或堵封件，冗余电缆引入口须用堵封件有效密封。
- 用于爆炸性气体环境中，现场安装、使用和维护必须严格遵守“断电后开盖！”的警告语。用于爆炸性粉尘环境中，现场安装、使用和维护必须严格遵守“爆炸性粉尘场所严禁开盖！”的警告语。

5. 用于爆炸性粉尘环境中，产品外壳表面需保持清洁，以防粉尘堆积，但严禁用压缩空气吹扫。
6. 用户不得自行更换该产品的零部件，应会同产品制造商共同解决运行中出现的故障，以杜绝损坏现象的发生。
7. 产品的安装、使用和维护应同时遵守产品使用说明书、GB/T 3836.13-2021“爆炸性环境 第 13 部分：设备的修理、检修、修复和改造”、GB/ T3836.15-2017“爆炸性气体环境用电气设备 第 15 部分：危险场所电气安装（煤矿除外）”、GB/ T3836.16-2017“爆炸性气体环境用电气设备 第 16 部分：电气装置的检查和维护（煤矿除外）”和 GB50257-2014“电气装置安装工程爆炸和火灾危险环境电力装置施工及验收规范”的有关规定。

9.7.2 I3 China Intrinsic Safety

Certificate	GYJ21.1278X
Standards	GB/T3836.1-2021, GB/T 3836.4-2021
Markings	HART: Ex ia IIC T5/T6 Ga Fieldbus: Ex ia IIC T4 Ga

- 产品安全使用特殊条件
证书编号后缀“X”表明产品具有安全使用特殊条件：
 1. 产品外壳含有轻金属，用于 0 区时需注意防止由于冲击或摩擦产生的点燃危险。
产品选用瞬态保护端子板（选项代码为 T1）时，此设备不能承受 500V 交流有效值试验电压的介电强度试验。
- 产品使用注意事项
 1. 产品温度组别与使用环境温度范围的关系：

输出	温度组别	环境温度
HART®	T6	$-60\text{ °C} \leq T_a \leq +50\text{ °C}$
	T5	$-60\text{ °C} \leq T_a \leq +75\text{ °C}$
Fieldbus	T4	$-60\text{ °C} \leq T_a \leq +60\text{ °C}$

本安电气参数：

Table 9-1: Power loop terminals (+ and -)

输出	最高输入电压 U_i (V)	最大输入电流 I_i (mA)	最大输入功率 P_i (W)	最大内部等效参数	
				C_i (nF)	L_i (μ H)
HART	30	300	1	5	0
Fieldbus	30	300	1.3	2.1	0
FISCO	17.5	380	5.32	2.1	0

Table 9-2: Sensor terminals (1 to 5)

输出	最高输出电压 U_o (V)	最大输出电流 I_o (mA)	最大输出功率 P_o (W)	最大内部等效参数	
				C_i (nF)	L_i (μ H)
HART	13.6	56	0.19	78	0
Fieldbus	13.9	23	0.079	7.7	0

Table 9-3: Load connected to sensor terminals (1 to 5)

输出	组别	最大外部等效电路		
		C_o (μ F)	L_o (mH)	L/R (μ H/ Ω)
HART	IIC	0.74	11.7	93
	IIB	5.12	44	341
	IIA	18.52	94	700
Fieldbus	IIC	0.73	30.2	187
	IIB	4.8	110.9	710
	IIA	17.69	231.2	1300

2. 该产品必须与已通过防爆认证的关联设备配套共同组成本安防爆系统方可用于爆炸性气体环境。其系统接线必须同时遵守本产品 and 所配关联设备的使用说明书要求，接线端子不得接错。
3. 用户不得自行更换该产品的零部件，应会同产品制造商共同解决运行中出现的故障，以杜绝损坏现象的发生。
4. 产品的安装、使用和维护应同时遵守产品使用说明书、GB/T3836.13-2021“爆炸性环境 第 13 部分：设备的修理、检修、修复和改造”、GB/T 3836.15-20170“爆炸性气体环境用电气设备 第 15 部分：电气装置的设计、选型和安装”、GB/T 3836.16-20226“爆炸性气体环境用电气设备 第 16 部分：电气装置的检查和维护”、

GB50257-2014“电气装置安装工程爆炸和火灾危险环境电力装置施工及验收规范”的有关规定。

9.7.3 N3 China Type n

Certificate GYJ20.1086X [Fieldbus]; GYJ20.1091X [HART]

Standards GB/T 3836.1-2021, GB/T 3836.3-2021

Markings [Fieldbus]: Ex ec IIC T5 Gc
[HART]: Ex ec IIC T5/T6 Gc
[Fieldbus]; Ex nA IIC T5/T6 Gc [HART]

Output	T code	Ambient temperature
Fieldbus	T5	$-40\text{ °C} \leq T_a \leq +75\text{ °C}$
HART	T6	$-40\text{ °C} \leq T_a \leq +50\text{ °C}$
	T5	$-40\text{ °C} \leq T_a \leq +75\text{ °C}$

- 产品安全使用特殊条件
产品防爆合格证后缀“X”代表产品安全使用有特殊条件：
此设备不能承受 500V 交流有效值介电强度试验，耐，安装时必须考虑在内。
- 产品使用注意事项
Fieldbus: $-40\text{ °C} \leq T_a \leq +75\text{ °C}$
HART:

温度组别	环境温度
T5	$-40\text{ °C} \leq T_a \leq +75\text{ °C}$
T6	$-40\text{ °C} \leq T_a \leq +50\text{ °C}$

1. 输入参数:
Fieldbus:
 $U_i = 32\text{ Vdc}$
 $C_i = 2.1\text{ nF}$ (Loop terminals)
 $C_i = 7.7\text{ nF}$ (Sensor terminals)
 $L_i = 0$
HART:
 $U_i = 42.4\text{ Vdc}$
2. 产品外壳设有接地端子，用户在安装使用时应可靠接地。
3. 产品外壳防护等级（IP 代码）为 IP54。
4. 现场安装时，电缆引入口须选用国家指定的防爆检验机构按检验认可、符合 GB/T 3836.1-2021、GB/T 3836.3-2021 要求且具有 Ex

ec IIC 防爆等级、达到 IP6X 外壳防护等级的电缆引入装置或堵封件，冗余电缆引入口须用堵封件有效密封。

5. 用户不得自行更换该产品的零部件，应会同产品制造商共同解决运行中出现的故障，以杜绝损坏现象的发生。
6. 产品的安装、使用和维护应同时遵守产品使用说明书、GB/T3836.13-2021“爆炸性环境 第 13 部分：设备的修理、检修、修复和改造”、GB/T3836.15-2017“爆炸性环境 第 15 部分：电气装置的设计、选型和安装”、GB/T3836.16-2022“爆炸性环境 第 16 部分：电气装置的检查与维护”和 GB50257-2014“电气装置安装工程爆炸和火灾危险环境电力装置施工及验收规范”的有关规定。

K3 Combination China Explosionproof & Dust-Ignition proof, China Intrinsic Safety and China type N

9.8 EAC - Belarus, Kazakhstan, Russia

9.8.1 EM EAC Flameproof

Markings 1Ex db IIC T6...T1 Gb X, T6(-60 °C ≤ T_a ≤ +70 °C), T5...T1(-60 °C ≤ T_a ≤ +80 °C)

Special Condition for Safe Use (X):

Refer to certificate for details regarding process and ambient temperature limits as well as Special Conditions for Safe Use.

9.8.2 IM EAC Intrinsic Safety

Markings [HART]: 0Ex ia IIC T5, T6 Ga X, T6(-60 °C ≤ T_a ≤ +50 °C), T5(-60 °C ≤ T_a ≤ +75 °C);
[Fieldbus/PROFIBUS®]: 0Ex ia IIC T4 Ga X, T4(-60 °C ≤ T_a ≤ +60 °C)

See [Table 9-7](#) for entity parameters.

Special Condition for Safe Use (X):

Refer to certificate for details regarding process and ambient temperature limits as well as Special Conditions for Safe Use.

9.8.3 KM EAC Flameproof, Intrinsic Safety, and Dust-Ignitionproof

Markings Ex tb IIIC T130 °C Db X (-60 °C ≤ T_a ≤ +80 °C), IP66 in addition to markings listed for EM and IM above.

Special Condition for Safe Use (X):

Refer to certificate for details regarding process and ambient temperature limits as well as Special Conditions for Safe Use.

See [EM EAC Flameproof](#) for flameproof specific conditions of use and see [IM EAC Intrinsic Safety](#) for intrinsic safety specific conditions of use.

9.9 Japan

9.9.1 E4 Japan Flameproof

Certificate CML 21JPN1842X

Markings Ex db IIC T6...T1 Gb; T6 (-60 °C ≤ T_a ≤ +70 °C); T5...T1 (-60 °C ≤ T_a ≤ +80 °C)

Special Conditions for Safe Use:

1. Flameproof joints are not intended for repair.
2. Non-standard paint options may cause risk from electrostatic discharge. Avoid installations that could cause electrostatic build-up on painted surfaces, and only clean the painted surfaces with a damp cloth. If paint is ordered through a special option code, contact the manufacturer for more information.
3. See instructions for relation between process temperature, ambient temperature and temperature class.

Additional Special Condition for Safe Use (X) when "XA" designation is ordered:

Guard DIN Style sensors against impacts greater than 4J.

Process temperature range at sensor connection (°C) ⁽¹⁾	Ambient temperature range (°C)	Temperature class
-60 °C to +70 °C	-60 °C to +70 °C	T6
-60 °C to +80 °C	-60 °C to +80 °C	T5...T1

(1) Sensor Connection is where the sensor threads into the transmitter or junction box housing.

9.10 Korea

9.10.1 EP Korea Flameproof

Certificate 22-KA4BO-0079X (flameproof), 22-KA4BO-0075X (dust)

Markings Ex db IIC Gb T6...T1; T6 (-60 °C ≤ T_{amb} ≤ +70 °C), T5 (-60 °C ≤ T_{amb} ≤ +80 °C)

Ex tb IIIC T130 °C Db; (-60 °C ≤ T_{amb} ≤ +80 °C)

Special Condition for Safe Use (X):

See certificate for special conditions.

9.10.2 IP Korea Intrinsic Safety

Certificate 09-KB4BO-0028X

Markings Ex ia IIC T6/T5 Ga; T6(-60 °C ≤ T_{amb} ≤ +50 °C), T5(-60 °C ≤ T_{amb} ≤ +75 °C)

Special Condition for Safe Use (X):

See certificate for special conditions.

9.11 Combinations

- K1** Combination of E1, I1, N1, and ND
- K2** Combination of E2 and I2
- K5** Combination of E5 and I5
- K7** Combination of E7, I7, and N7
- KA** Combination of K1 and K6
- KB** Combination of K5, I6, and K6
- KM** Combination of EM and IM
- KP** Combination of EP and IP

9.12 Tables

Process temperature limits

Table 9-4: Transmitter

Extension length	Process temperature [°C]						
	Gas						Dust
	T6	T5	T4	T3	T2	T1	T130 °C
No extension	55	70	100	170	280	440	100
3-in. extension	55	70	110	190	300	450	110
6-in. extension	60	70	120	200	300	450	110
9-in. extension	65	75	130	200	300	450	120

Adhering to the process temperature limitations of [Table 9-6](#) will ensure that the service temperature limitations of the LCD cover are not exceeded. Process temperatures may exceed the limits defined in

Table 9-6 if the temperature of the LCD cover is verified to not exceed the service temperatures in Table 9-6 and the process temperatures do not exceed the values specified in Table 9-4.

Table 9-5: Transmitter with LCD cover

Extension length	Process temperature [°C]			
	Gas			Dust
	T6	T5	T4...T1	T130 °C
No extension	55	70	95	95
3-in. extension	55	70	100	100
6-in. extension	60	70	100	100
9-in. extension	65	75	110	110

Table 9-6: Transmitter with LCD cover

Service temperature [°C]			
Gas			Dust
T6	T5	T4...T1	T130 °C
65	75	95	95

Entity parameters

Table 9-7: Entity parameters

Parameters	HART®	Fieldbus/ PROFIBUS	FISCO
Voltage U_i (V)	30	30	17.5
Current I_i (mA)	300	300	380
Power P_i (W)	1	1.3	5.32
Capacitance C_i (nF)	5	2.1	2.1
Inductance L_i (mH)	0	0	0

9.13 Additional certifications

SBS American Bureau of Shipping (ABS) type approval

Certificate 21-2097596-PDA

Intended use Measurement of temperature for marine and offshore applications

SBV Bureau Veritas (BV) type approval

Certificate 23154

Requirements Bureau Veritas rules for the classification of steel ships

Application Class notations: AUT-UMS, AUT-CCS, AUT-PORT and AUT-IMS; temperature transmitter type 3144P cannot be installed on diesel engines

SDN Det Norske Veritas (DNV) type approval

Certificate TAA00001JK

Intended use Det Norske Veritas' rules for classification of ships, high speed, and light craft and Det Norske Veritas' offshore standards

Application **Table 9-8: Location classes**

Temperature	D
Humidity	B
Vibration	A
EMC	A
Enclosure	D

SLL Lloyds Register (LR) type approval

Certificate LR21173788TA

Application Environmental categories ENV1, ENV2, ENV3, and ENV5

9.14 Installation drawings for Intrinsic Safety

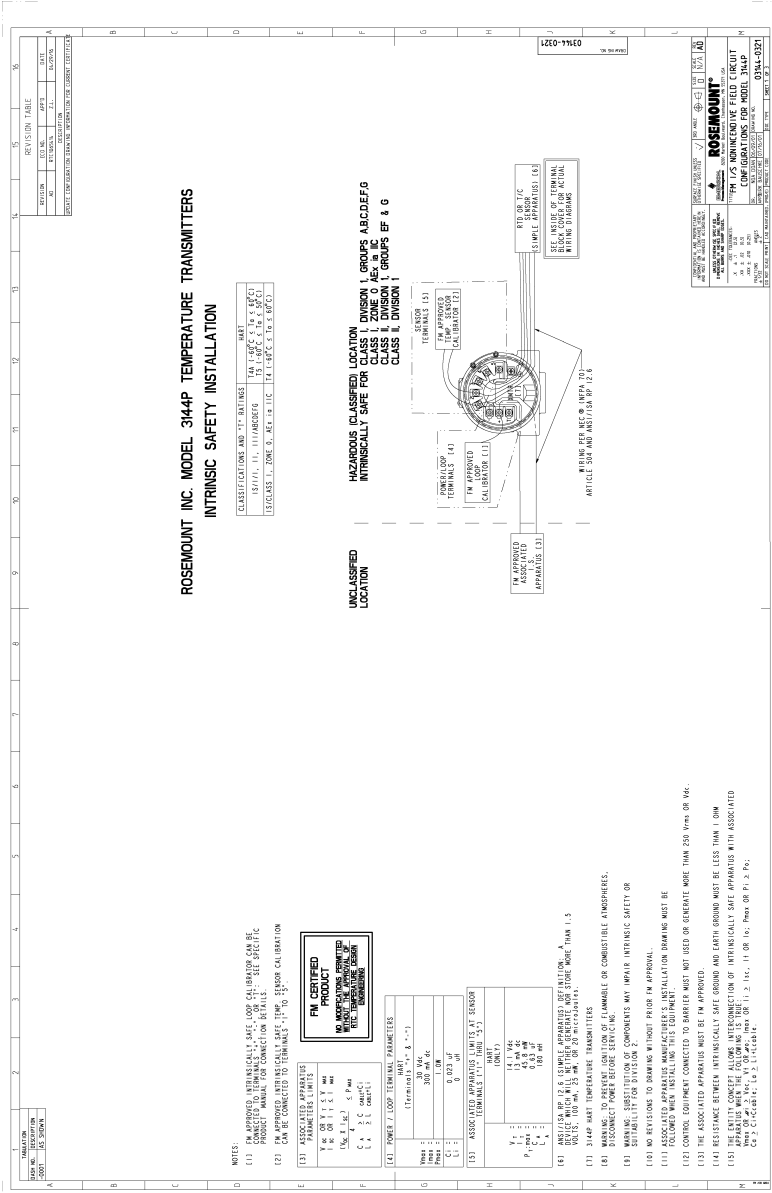

Revised: None - PRINTED COPIES ARE UNCONTROLLED - Rosemount Property

**ROSEMOUNT INC. MODEL 344P TEMPERATURE TRANSMITTER
DIV. 2 INSTALLATION OPTIONS**

CLASSIFICATION	INDUSTRIES
GROUP 1	HAZARDOUS LOCATIONS
CLASSIFICATION	TEMPERATURE
GROUP 1	TEMPERATURE
CLASSIFICATION	TEMPERATURE
GROUP 1	TEMPERATURE

**DIV. 2 HAZARDOUS CLASSIFIED LOCATION
SUITABLE FOR CLASS 1, DIVISION 2, GROUPS A, B, C, & D**

UNCLASSIFIED LOCATION

OPTION 1

UNSPECIFIED EQUIPMENT

SEE NOTE OF TERMINAL BLOCK OUTER OR ACTUAL SIGNAL WIRING 2 (SUBPAGE 16)

RIS OR JIC

STIMPLE APPARATUS 16

OPTION 2

UNSPECIFIED EQUIPMENT

SEE NOTE OF TERMINAL BLOCK OUTER OR ACTUAL SIGNAL WIRING 2 (SUBPAGE 16)

RIS OR JIC

STIMPLE APPARATUS 16

OPTION 3

FM APPROXIMATE CALIBRATION (131)

SEE NOTE OF TERMINAL BLOCK OUTER OR ACTUAL SIGNAL WIRING 2 (SUBPAGE 16)

RIS OR JIC

STIMPLE APPARATUS 16

NOTES:

1)11. INTERNALLY SAFE OR NONINHERENTLY SAFE FIELD CIRCUIT CONSTRUCTION FOR DIVISION 2, GROUP A, B, C, & D: SEE SPECIFIC PRODUCT MANUAL FOR CONNECTION DETAILS.

12) APPROVED FOR USE FOR DIVISION 2 LOCATIONS CAN BE CONNECTED TO UNCLASSIFIED LOCATIONS.

13) ASSOCIATED NONINHERENTLY SAFE APPARATUS PARAMETERS, LIMITS:

Ca	Class 1, Div 2
Cb	Class 1, Div 2
Cc	Class 1, Div 2
Cd	Class 1, Div 2

14) TRANSMITTER POWER/LOOP TERMINAL PARAMETER LIMITS:

V	12VDC
I	10mA
C	1000pF
W	1000Ω

15) ASSOCIATED NONINHERENTLY SAFE FIELD CIRCUIT PARAMETERS, LIMITS:

V	14.1 VAC
I	0.04 A
C	1000 pF
W	1000 Ω

16) THE 16-PIN JIC OR JIC STIMPLE APPARATUS SETTING IN THE DIVISION 2 WIRING WILL NOT GENERATE AND STORE MORE THAN 1.3 MA.

17) 344P HAZARDOUS TEMPERATURE TRANSMITTERS.

18) HAZARDOUS TEMPERATURE TRANSMITTERS.

19) HAZARDOUS TEMPERATURE TRANSMITTERS.



ROSEMOUNT	
ROSEMOUNT INC.	344P
10000 WALKER BLVD	HOUSTON, TX 77066
TEL: 281-255-2000	FAX: 281-255-2001
WWW.ROSEMOUNT.COM	
U.S. PATENT OFFICE REG. NO. 4,488,317 CANADIAN PATENT NO. 2,458,262 U.S. PATENT OFFICE REG. NO. 4,488,318 CANADIAN PATENT NO. 2,458,263 U.S. PATENT OFFICE REG. NO. 4,488,319 CANADIAN PATENT NO. 2,458,264	
U.S. PATENT OFFICE REG. NO. 4,488,320 CANADIAN PATENT NO. 2,458,265 U.S. PATENT OFFICE REG. NO. 4,488,321 CANADIAN PATENT NO. 2,458,266	

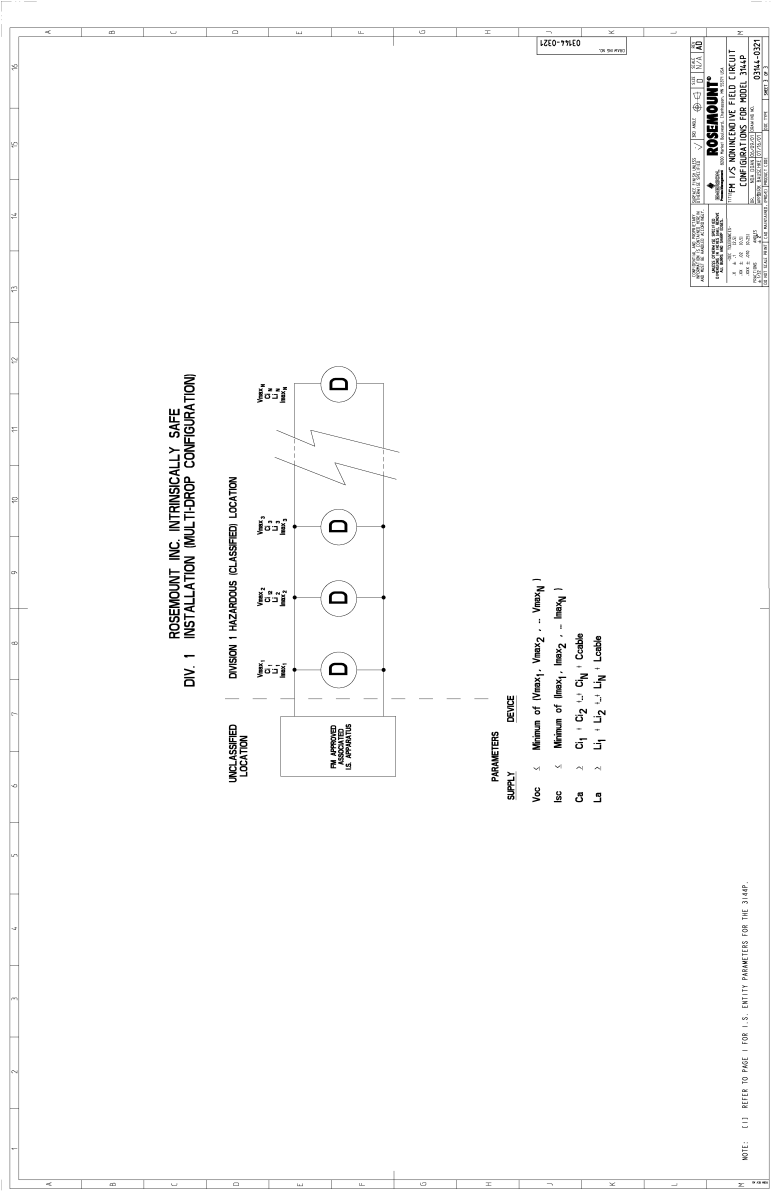

Revised: None - PRINTED COPIES ARE UNCONTROLLED - Rosemount Property

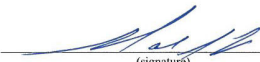

Electronic Notes – PRINTED COPIES ARE UNCONTROLLED – Rosemount Engineering

9.15 Declaration of conformity

	EU Declaration of Conformity No: RMD 1045 Rev. P	
<p>We,</p> <p style="margin-left: 40px;">Rosemount, Inc. 6021 Innovation Boulevard Shakopee, MN 55379-4676 USA</p> <p>declare under our sole responsibility that the product,</p> <p style="text-align: center;">Rosemount™ 3144P Temperature Transmitter</p> <p>manufactured by,</p> <p style="margin-left: 40px;">Rosemount, Inc. 6021 Innovation Boulevard Shakopee, MN 55379-4676 USA</p> <p>to which this declaration relates, is in conformity with the provisions of the European Union Directives, including the latest amendments, as shown in the attached schedule.</p> <p>Assumption of conformity is based on the application of the harmonized standards and, when applicable or required, a European Union notified body certification, as shown in the attached schedule.</p>		
 _____ (signature)	Vice President of Global Quality _____ (function)	
Mark Lee _____ (name)	<i>October 22, 2021</i> _____ (date of issue)	
Page 1 of 3		

 **EU Declaration of Conformity** 

No: RMD 1045 Rev. P

EMC Directive (2014/30/EU)

Harmonized Standards: EN61326-1:2013, EN61326-2-3: 2013

ATEX Directive (2014/34/EU)

Rosemount 3144P Temperature Transmitter (4-20mA/HART Output)

BAS01ATEX1431X – Intrinsic Safety Certificate
Equipment Group II, Category 1 G (Ex ia IIC T5/T6 Ga)
Harmonized Standards:
EN IEC 60079-0:2018, EN60079-11:2012



BAS01ATEX3432X – Type n Certificate
Equipment Group II, Category 3 G (Ex nA IIC T5/T6 Gc)
Harmonized Standards:
EN IEC 60079-0:2018, EN60079-15:2010

Rosemount 3144P Temperature Transmitter (Fieldbus Output)

Baseefa03ATEX0708X – Intrinsic Safety Certificate
Equipment Group II, Category 1 G (Ex ia IIC T4 Ga)
Harmonized Standards:
EN IEC 60079-0:2018, EN60079-11:2012

Baseefa03ATEX0709 – Type n Certificate
Equipment Group II, Category 3 G (Ex nA IIC T5 Gc)
Harmonized Standards:
EN IEC 60079-0:2018, EN60079-15:2010

Page 2 of 3

 **EU Declaration of Conformity** 

No: RMD 1045 Rev. P

Rosemount 3144P Temperature Transmitter (all Output Protocols)

DEKRA 19ATEX0076 X – Dust Certificate
Equipment Group II, Category 2 D (Ex tb IIC T130°C Db)
Harmonized Standards:
EN IEC 60079-0:2018, EN 60079-31:2014

DEKRA 19ATEX0076 X – Flameproof Certificate
Equipment Group II, Category 2 G (Ex db IIC T6...T1 Gb)
Harmonized Standards:
EN IEC 60079-0:2018, EN 60079-1:2014

ATEX Notified Bodies

SGS FIMKO OY [Notified Body Number: 0598]
Takomotie 8
00380 HELSINKI
Finland

Dekra Certification B.V. [Notified Body Number: 0344]
Utrechtseweg 310
Postbus 5185
6802 ED Arnhem
Netherlands

ATEX Notified Body for Quality Assurance

SGS FIMKO OY [Notified Body Number: 0598]
Takomotie 8
00380 HELSINKI
Finland

Page 3 of 3

9.16 China RoHS

有害物质成分表
00079-2000, Rev AB

罗斯蒙特产品型号 3144P
7/1/2016

含有 China RoHS 管控物质超过最大浓度限值的部件型号列表 3144P
List of 3144P Parts with China RoHS Concentration above MCVs

部件名称 Part Name	有害物质 / Hazardous Substances					
	铅 Lead (Pb)	汞 Mercury (Hg)	镉 Cadmium (Cd)	六价铬 Hexavalent Chromium (Cr +6)	多溴联苯 Polybrominated biphenyls (PBB)	多溴联苯醚 Polybrominated diphenyl ethers (PBDE)
电子组件 Electronics Assembly	X	○	○	○	○	○
壳体组件 Housing Assembly	○	○	○	X	○	○
传感器组件 Sensor Assembly	X	○	○	○	○	○

本表格系依据 SJ/T11364 的规定而制作。

This table is proposed in accordance with the provision of SJ/T11364.

○: 意为该部件的所有均质材料中该有害物质的含量均低于 GB/T 26572 所规定的限量要求。

O: Indicate that said hazardous substance in all of the homogeneous materials for this part is below the limit requirement of GB/T 26572.

X: 意为在该部件所使用的的所有均质材料里, 至少有一类均质材料中该有害物质的含量高于 GB/T 26572 所规定的限量要求。

X: Indicate that said hazardous substance contained in at least one of the homogeneous materials used for this part is above the limit requirement of GB/T 26572.

部件名称 Part Name	组装备件说明 Spare Parts Descriptions for Assemblies
电子组件 Electronics Assembly	电子线路板组件 Electronic Board Assemblies 端子块组件 Terminal Block Assemblies 液晶显示屏或本地操作界面 LCD or LOI Display
壳体组件 Housing Assembly	电子外壳 Electrical Housing



Quick Start Guide
00825-0100-4021, Rev. SC
January 2024

For more information: [Emerson.com/global](https://www.emerson.com/global)

©2024 Emerson. All rights reserved.

Emerson Terms and Conditions of Sale are available upon request. The Emerson logo is a trademark and service mark of Emerson Electric Co. Rosemount is a mark of one of the Emerson family of companies. All other marks are the property of their respective owners.

ROSEMOUNT™

