

Rosemount™ RBI pH/ORP Sensors



Safety information

⚠ WARNING

Hot surface

Before removing the sensor, be absolutely certain that the process pressure is reduced to 0 psig and the process temperature is lowered to a safe level.

⚠ WARNING

Corrosive substance

The solution used during calibration is an acid.

- Handle with care.
- Follow the directions of the acid manufacturer.
- Wear proper protective equipment.
- Do not let the solution come in contact with skin or clothing.
- If contact with skin is made, immediately rinse with clean water.

⚠ CAUTION

Application compatibility

The wetted sensor materials may not be compatible with process composition and operating conditions.

Application compatibility is entirely the operator's responsibility.

⚠ WARNING

Physical access

Unauthorized personnel may potentially cause significant damage to and/or misconfiguration of end users' equipment. This could be intentional or unintentional and needs to be protected against.

Physical security is an important part of any security program and fundamental to protecting your system. Restrict physical access by unauthorized personnel to protect end users' assets. This is true for all systems used within the facility.

Contents

Overview..... 3

Installation..... 5

Startup..... 22

Accessories..... 23

1 Overview

1.1 Unpack and inspect

Procedure

1. Inspect the shipping container. If it is damaged, contact the shipper immediately for instructions.
2. If there is no apparent damage, unpack the container. Be sure all items shown on the packing list are present. If items are missing, notify Emerson immediately.

1.2 Specifications

Rosemount RBI pH/ORP Sensor Specifications

Measurement range	pH: 0 to 14 ORP: -1500 to +1500 mV
Wetted materials	Kynar [®] , titanium (retractable 547 only), porous PTFE, wood, glass, and choice of EPDM, Viton [®] , or Kalrez [®]
Maximum temperature	248 °F (120 °C) at 40 psig (276 kPa [abs])
Maximum pressure	150 psig (1,035 kPa [abs]) at 158 °F (70 °C)
Maximum insertion pressure (option 547)	65 psig (448 kPa [abs]) at 158 °F (70 °C)
Maximum retraction pressure (option 547)	40 psig (276 kPa [abs]) at 248 °F (120 °C)
Process connection	Body type 546: Forward and rear facing ¾-in. MNPT Body type 547: None, requires user-supplied 1-in. MNPT process fitting or ball valve set.

1.3 Storage and maintenance

Sensors require little care or maintenance. Simple guidelines follow:

During storage, keep sensors near room temperature and capped on the measuring end. These caps supplied from the factory are filled with a weak pH 7 buffer in order to keep the sensor wet. Check sensors in storage semi-annually to assure that the cap retains moisture; if the pH 7 buffer evaporates, replace it with ordinary tap water.

Cleaning the pH sensor is easy. The reference usually does not require maintenance. If a coating forms over the exposed portion of the reference, scrape it off with a small penknife. Take care not to break the glass when scraping the reference.

Glass pH electrodes can be cleaned in a number of ways. To remove scaling, oils, and other stubborn coatings, soak the electrode in a five to ten percent HCl solution for a few minutes and then rinse it under tap water. Very heavy coatings may require more than one soaking. To clean minor coatings, direct a stream of tap water directly onto the glass. With new sensors, wipe the glass with a clean, soft cloth. Take care with this approach as the glass may break when mishandled.

Oils or greases that can accumulate on the glass bulb may not be visible to the eye. To remove these, stir the sensor in a solvent such as isopropyl alcohol. Heavy build-up may require a number of alcohol cycles followed by wiping with a soft cloth. You may also use a dish soap.

Run sensor cables through the conduit or protect them from the environment; they are not weather-proof. Do not allow cables and connectors to become wet, lay on the ground or across equipment, etc. Do not abrade, pinch, twist, or sharply bend cables.

2 Installation

2.1 RBI 546 Installation

Figure 2-1: In-Line Submersion Option 546 with Integral Cable Connection

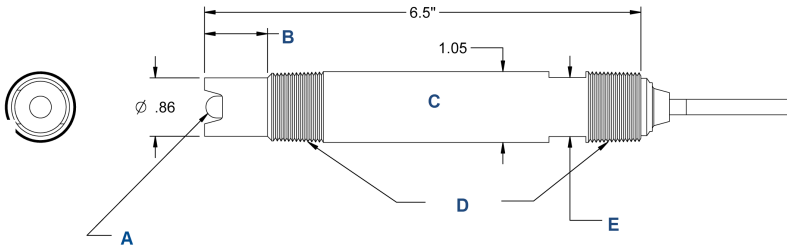

- A. Measuring electrode: choice of ruggedized hemi glass, ruggedized flat glass, or flat platinum ORP (non-glass)
Reference junction: PTFE junction flat and flash or PTFE junction with notched glass protection
- B. L - insertion depth (see [Table 2-1](#))
- C. Kynar® body
- D. 3/4-in. MNPT
- E. 7/8-in. wrench flats

Table 2-1: Insertion Depth

Option	L
05	0.5-in. (12.7 mm)
10	1.0-in. (25.4 mm)
15	1.5-in. (38 mm)

Figure 2-2: In-Line Submersion Option 546 with Variopol Cable Connection

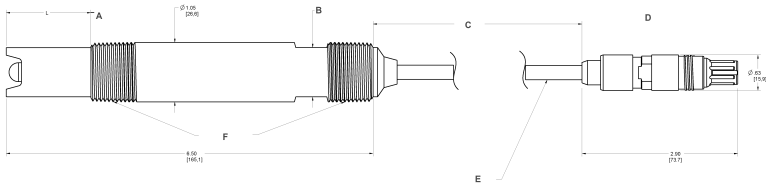

- A. Insertion depth (see [Table 2-2](#))
- B. 7/8-in. flats
- C. 8-in. cable
- D. VP8 male connector
- E. 1/4-in. cable
- F. 3/4-in. MNPT thread

Table 2-2: Insertion Depth

Option	L
05	0.5-in. (12.7 mm)
10	1.0-in. (25.4 mm)
15	1.5-in. (38 mm)

Procedure

1. For integral cable sensors, reference [Figure 2-1](#)-dimension B to select appropriate mounting nozzle or pipe tee dimensions to achieve desired insertion depth.
2. For VP sensors, reference [Figure 2-2](#)-dimension B to select appropriate mounting nozzle or pipe tee dimensions to achieve desired insertion depth.
3. Wrap the sensor threads (D) with PTFE tape to prevent leakage.
 - a) Use front facing threads for insertion installations in a pipe tee/process nozzle.
 - b) Use rear facing threads for submersion installations threaded into conduit.
4. Do not overtighten sensor into its receptacle.
5. Hand tighten the sensor, then tighten one or two turns with a wrench to secure in place.

2.2 RBI 547 installation

Figure 2-3: Titanium Sheath Dimensions (for 547 Option)

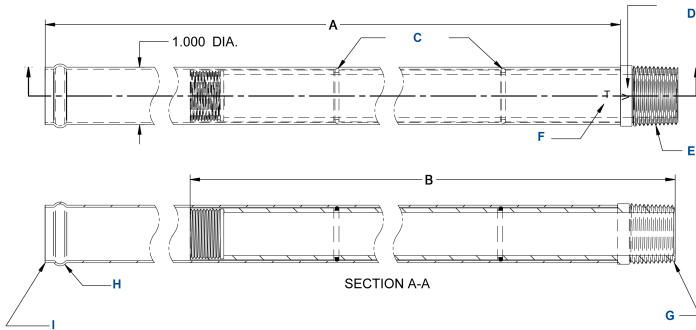

- A. A length (see [Table 2-3](#))
- B. B length (see [Table 2-3](#))
- C. O-rings (see [Table 2-3](#))
- D. O-ring material I.D. (V = Viton®, E = EPDM, K = Kalrez®)
- E. 3/4-in. MNPT
- F. Sheath material I.D. (T = titanium, H = Hastelloy C)
- G. Extension Kynar
- H. Swage
- I. Titanium sheath

Table 2-3: Titanium Sheath Dimensions (for 547 Option)

Part number	Sheath materials	O-ring materials	A length	B length
RB5104-0058E	T	E	7-in. (177.8 mm)	1.9-in. (48.3 mm)
RB5104-0078E	H	E		
RB5104-0120E	T	E	19-in. (482.6 mm)	13.9-in. (353.1 mm)
RB5104-0120V	T	V		
RB5104-0320E	H	E		
RB5104-0320K	H	K		
RB5104-0136E	T	E	35-in. (889 mm)	29.9-in. (759.5 mm)
RB5104-0336E	H	E		

Figure 2-4: Retractable Body Type Sensor (547) with Integral Cable Connection and Sheath

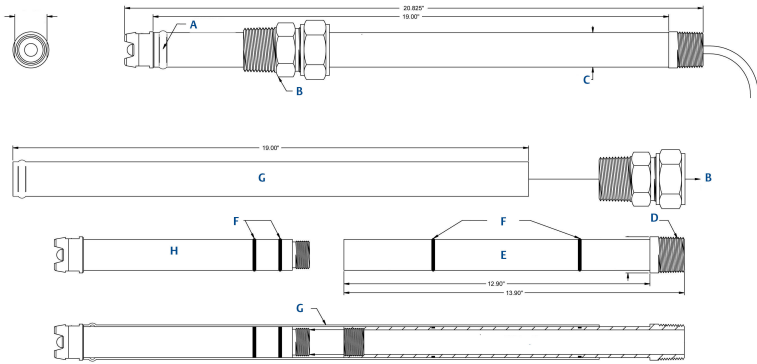

Shown with 20-in. (508 mm) sheath (RB5104-0120E/RB5104-0120V/RB5104-0320E)

- A. Blowout safety stop
- B. Fitting sold separately
- C. 1.00-in. (25.4 mm) diameter
- D. $\frac{3}{4}$ -in NPT thread
- E. Kynar[®] extension
- F. O-rings
- G. Sensor sheath
- H. Sensor cartridge

Figure 2-5: Retractable Option 547 with Variopool Cable Connection

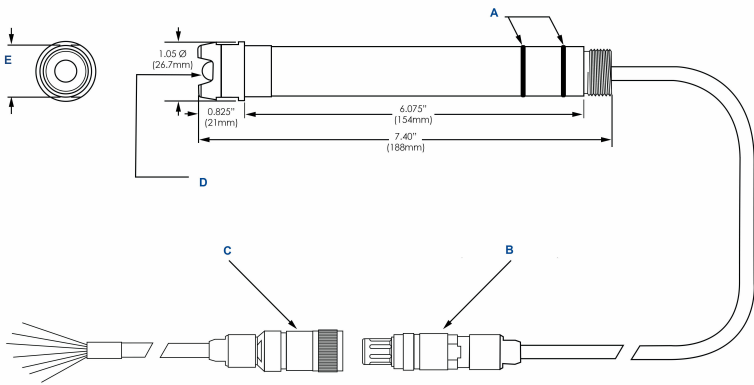

- A. O-rings
- B. VP8 connector option (24 in. [609.6 mm] cable length)
- C. VP8 connector cable (part #24281-XX)
- D. Available options include: hemi or flat glass electrodes, notched or flush tip configurations
- E. 15/16-in. wrench flats

Figure 2-6: RBI Retractable Body Type Sensor (547) with 1½-in. Ball Valve Assembly (PN 23240-00)

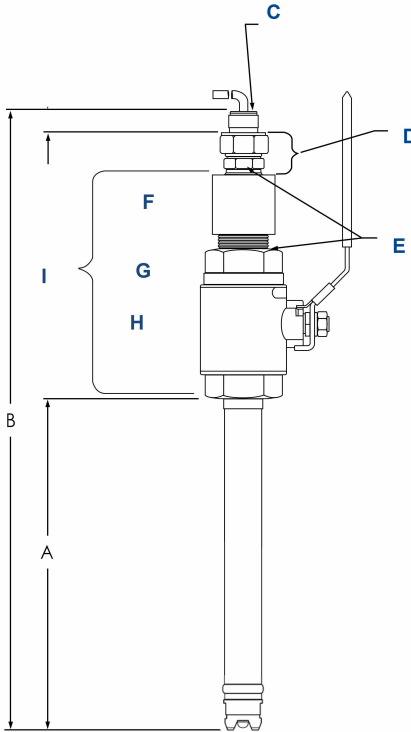

When inch and metric dimensions are given, millimeters are over inches.

- A. Length (see [Table 2-4](#))
- B. Length (see [Table 2-4](#))
- C. Cable bushing polypropylene
- D. 1-in. x 1-in. Swage fitting kit (PN 23166-00 or 23166-01) required to connect sensor directly to ball valve
- E. See warning below
- F. 1½-in. x 1-in. FPT reducing coupling
- G. 1½-in. MPT close nipple
- H. 1½-in. FPT ball valve PN 9340065
- I. Ball valve kit (PN 23240-00) optional

⚠ WARNING

High pressure

▲ WARNING

Residual pressure and process may remain trapped between ball valve and male connector.

Maximum pressure at retraction: 65 psig (option 546), 40 psig (option 547)

Note

Unless otherwise specified

Table 2-4: Length

A	B
11.4-in./290 mm	20.5-in./521 mm

The 1¼-in. ball valve kit assembly (PN 23765-00) is not shown above, but is also compatible with Rosemount RBI Retractable Body Type Sensor (547).

Note

Add five inches to length of sensor if mounting a sensor-head junction box onto the sensor.

Figure 2-7: Typical Mounting Details for the Retractable Body Type Sensor (547)

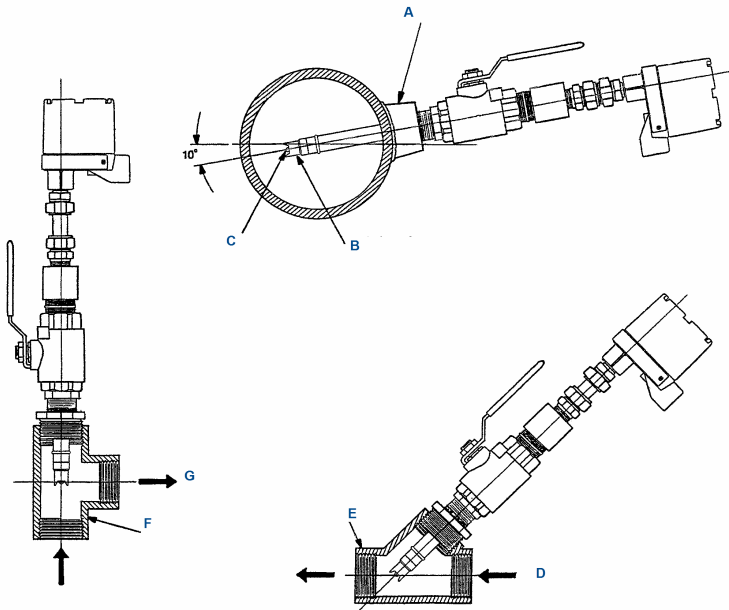

Note

Sensor must be mounted at an angle between 10 degrees and 90 degrees above the horizontal. Pipe tees and weldlets are customer supplied. Figure above shown with sensor head junction box PN 23709-00 (sold separately).

- A. Butt weld branch connection (1½-in. FPT)
- B. Electrode housing tip
- C. Electrode
- D. Flow
- E. Pipe Y
- F. Pipe tee
- G. Flow

For dimensional information on assembled retraction sheath, refer to [Figure 2-3](#).

All RBI 547 Assemblies consist of the pieces shown in [Figure 2-4](#).

Procedure

1. Remove extension piece (G) from sensor sheath (J)
2. Loosen compression fitting (B) several turns and gently push onto the sheath (L) with threads facing the blowout safety stop (A)
3. Lubricate O-rings on sensor cartridge (L) and Kynar extension (G) if needed.
4. Slide sensor into sheath until the tip bottoms out. Cable should be routed through the sheath a. For VP sensors (Figure 2-5), male VP plug (B) must be fully routed through the kynar extension
5. Hand tighten extension piece clockwise, so the threads engage those on the rear of the sensor.
6. If sensor cap is still in place, remove, and install sensor into process.
7. Reference Figure 2-6 for dimensional information on completed assembly to assist in setting the correct depth for the sensor into process

2.3 Wire sensor to transmitter

Procedure

1. Remove the protective covering on the white (reference) wire.
2. Wire the correct sensor leads to the main board using the lead locations marked directly on the board.

See the diagrams below. You may use either integral cables or Variopul cables.

NOTICE

Keep sensor and output signal wiring separate from loop power wiring. Do not run sensor and power wiring in the same conduit or close together in a cable tray.

NOTICE

Do not overtighten submersible sensors during installation.

Figure 2-8: Integral Cable Wiring

PT 100 TC

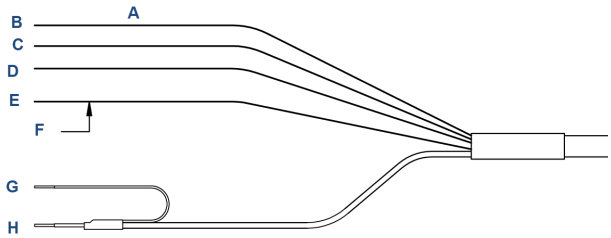

- A. 22 AWG leads
- B. Red (resistance temperature device in)
- C. Black (resistance temperature device sense)
- D. Green (resistance temperature device return)
- E. White (reference)
- F. Remove protective insulation before wiring
- G. Gray (pH shield)
- H. Coaxial center (pH in)

Figure 2-9: Rosemount RBI with Integral Cable Connection Wiring Diagram for Rosemount 56, 1056, 1057, and 1066 Transmitters

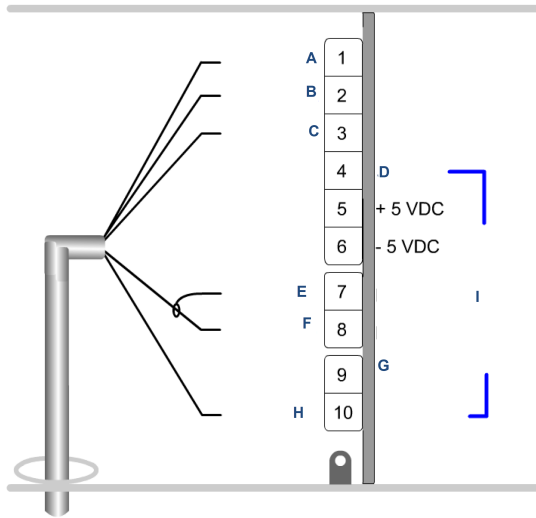

Table 2-5: Rosemount RBI with Integral Cable Connection Wiring Diagram for Rosemount 56, 1056, 1057, and 1066 Transmitters

Letter	Wire color	Terminal number	Description
A	Green	1	Resistance temperature device (RTD) return
B	Black	2	Resistance temperature device (RTD) sense
C	Red	3	Resistance temperature device (RTD) in
D	N/A	4	Ground
N/A	N/A	5	+5 Vdc
N/A	N/A	6	-5 Vdc
E	Gray	7	pH shield
F	Coaxial	8	pH in
G	None	9	Reference shield
H	White	10	Reference
I	N/A	4 to 10	Jumper

Figure 2-10: Example of Printed Circuit Board of the pH Card for Rosemount 1056, 56, and 1057 Transmitters

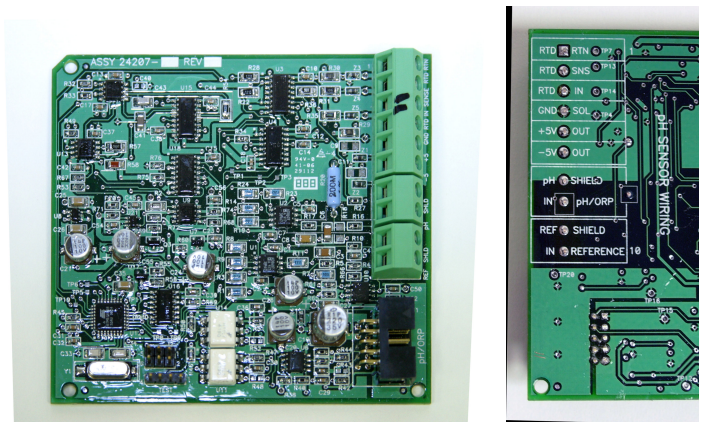

Figure 2-11: Rosemount RBI with Integral Cable Connection Wiring Diagram for Rosemount 5081 Transmitters

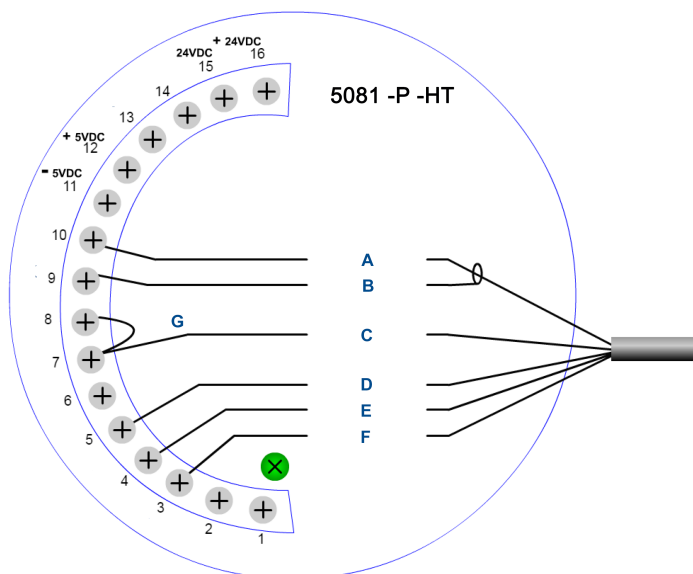

Table 2-6: Rosemount RBI with Integral Cable Wiring to Rosemount 5081

Letter	Wire color	Terminal number	Description
N/A	NA	1	N/A
N/A	N/A	2	N/A
F	Green	3	Resistance temperature device (RTD) return
E	Black	4	Resistance temperature device (RTD) sense
D	Red	5	Resistance temperature device (RTD) in
N/A	N/A	6	Drain
C	White	7	Reference
G	Jumper	8	Solution ground
B	Gray	9	Drain
A	Coaxial	10	mV in
N/A	N/A	11	-5 Vdc
N/A	N/A	12	+5 Vdc
N/A	N/A	13	Anode

Table 2-6: Rosemount RBI with Integral Cable Wiring to Rosemount 5081 (continued)

Letter	Wire color	Terminal number	Description
N/A	N/A	14	Cathode
N/A	N/A	15	-24 Vdc
N/A	N/A	16	+24 Vdc

Figure 2-12: Rosemount RBI with Variopole Cable (24281-XX) Wiring Diagram for Rosemount 56, 1056, and 1057 Transmitters

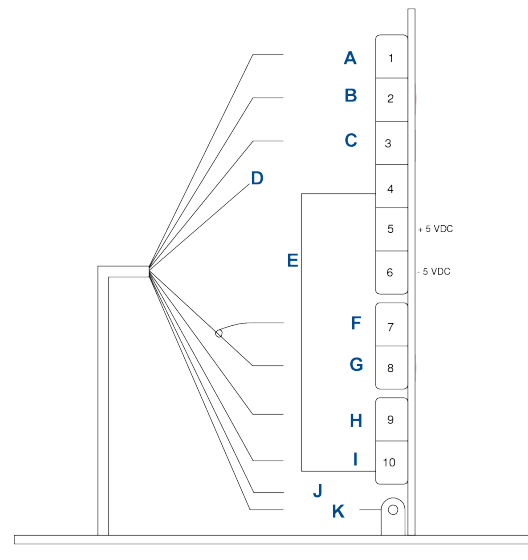

Table 2-7: Rosemount RBI with Variopole Cable (24281-xx) Wiring to Rosemount 56, 1056, and 1057 Transmitters

Letter	Wire color	Terminal number	Description
A	White	1	Resistance temperature device (RTD) return
B	White/red	2	Resistance temperature device (RTD) sense
C	Red	3	Resistance temperature device (RTD) in
D	Blue	N/A	No connect (cap)
E	Jumper	4 to 10	Ground

Table 2-7: Rosemount RBI with Variopol Cable (24281-xx) Wiring to Rosemount 56, 1056, and 1057 Transmitters (*continued*)

Letter	Wire color	Terminal number	Description
N/A	N/A	5	+5 Vdc
N/A	N/A	6	-5 Vdc
F	Clear	7	pH shield
G	Orange	8	pH in
H	White/gray	9	Reference shield
I	Gray	10	Reference
J	Clear ID	N/A	ID - no connect
K	Green	N/A	N/A

Figure 2-13: Rosemount RBI with Variopol Cable (24281-XX) Wiring Diagram for Rosemount 1066 Transmitters

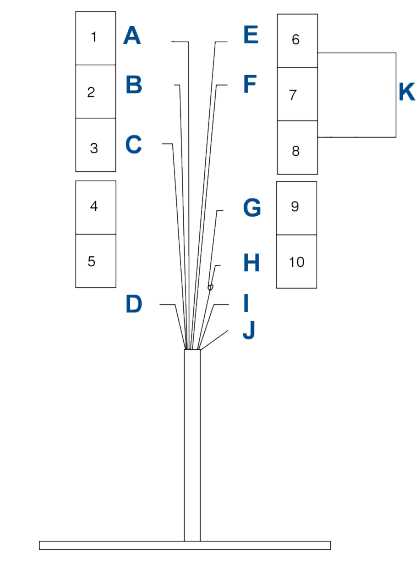

Table 2-8: Rosemount RBI with Variopol Cable (24281-xx) Wiring to Rosemount 1066 Transmitters

Letter	Wire color	Terminal number	Description
A	White	1	Resistance temperature device (RTD) return
B	White/red	2	Resistance temperature device (RTD) sense
C	Red	3	Resistance temperature device (RTD) in
N/A	N/A	4	+ volts
N/A	N/A	5	- volts
D	Green	N/A	No connect (cap)
E	Gray	6	Reference in
F	White/gray	7	Reference shield
N/A	N/A	8	Solution ground
K	N/A	6 to 8	Jumper
G	Clear	9	pH shield
H	Clear	10	pH in
I	N/A	N/A	No connect (cap)
J	Blue	N/A	No connect (cap)

**Figure 2-14: Rosemount RBI with Variopol Cable (24281-XX)
Wiring Diagram for Rosemount 5081 Transmitters**

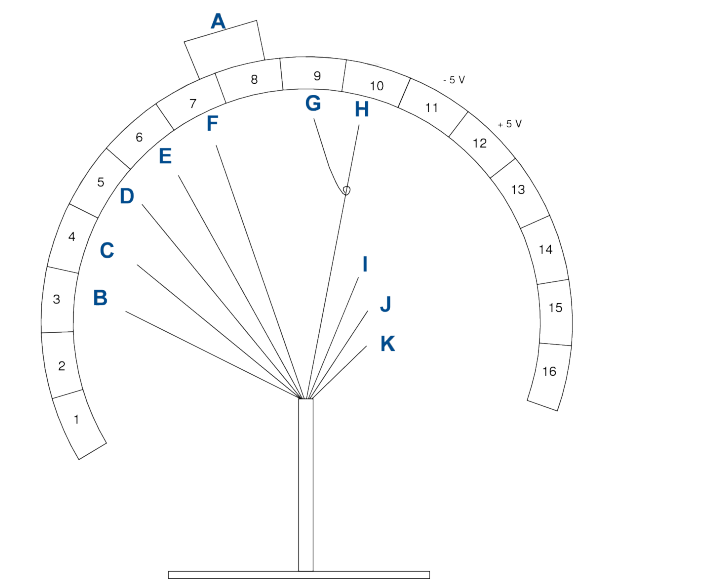

Table 2-9: Rosemount with Variopol Cable (24281-xx) Wiring to Rosemount 56, 1056, and 1057 Transmitters

Letter	Wire color	Terminal number	Description
N/A	N/A	1	Reserved
N/A	N/A	2	Reserved
B	White	3	Resistance temperature device (RTD) return
C	White/red	4	Resistance temperature device (RTD) sense
D	Red	5	Resistance temperature device (RTD) in
E	White/gray	6	Reference guard
F	Gray	7	Reference in
A	Jumper	8	Solution ground
G	Clear	9	pH/ORP ground
H	Orange	10	pH/ORP in
N/A	N/A	11	-5 V
N/A	N/A	12	+5 V

Table 2-9: Rosemount with Variopool Cable (24281-xx) Wiring to Rosemount 56, 1056, and 1057 Transmitters (continued)

Letter	Wire color	Terminal number	Description
N/A	N/A	13	Anode/reserved
N/A	N/A	14	Cathode/reserved
N/A	N/A	15	HART [®] /FOUNDATION [™] Fieldbus (-)
N/A	N/A	16	HART/FOUNDATION Fieldbus (+)
I	Blue	N/A	No connect (cap)
J	Green	N/A	Chassis screw
K	Clear	N/A	ID - no connect (cap)

3. After wiring the sensor leads, carefully take up the excess sensor cables through the cable gland.

3 Startup

Refer to the manual for your transmitter (Rosemount 56, 1056, 1057, 1066, or 5081) for directions on operating the transmitter after it has been wired to the sensor.

Procedure

1. Wire sensor(s) to the signal boards.
See [Wire sensor to transmitter](#) for wiring diagrams.
2. Once connections are secured and verified, apply power to the transmitter.

⚠ WARNING

Risk of electrical shock

Electrical installation must be in accordance with the National Electrical Code (ANSI/NFPA-70) and/or any other national or local codes.

When the transmitter is initially powered up, **Quick Start** screens appear.

3. Refer to the manual for your transmitter to complete the steps in the Quick Start process.

4 Accessories

Part number	Description
RB5104-0058E	8-in. (203,2 mm) titanium, Kynar®, EPDM, 547 retractable insertion sheath
RB5104-0078E	8-in. (203,2 mm) Hastelloy-C, Kynar, EPDM, 547 retractable insertion sheath
RB5104-0120E	20-in. (508 mm) titanium, Kynar, EPDM, 547 retractable insertion sheath
RB5104-0120V	20 in.(508 mm) titanium, Kynar, Viton®, 547 retractable insertion sheath
RB5104-0136E	36-in. (914,4 mm) titanium, Kynar, EPDM, 547 retractable insertion sheath
RB5104-0320E	20-in. (508 mm) Hastelloy-C, Kynar, EPDM, 547 retractable insertion sheath
RB5104-0336E	36-in. (914,4 mm) Hastelloy-C, Kynar, EPDM, 547 retractable insertion sheath
RB5104-0320K	20-in. (508 mm) Hastelloy-C, Kynar, Kalrez®, 547 retractable insertion sheath
23166-00	1-in. x 1-in. process connector, 316 stainless steel
23166-01	1-in. x 1-in. process connector, titanium
23240-00	1½-in. ball valve kit assembly, 316 stainless steel (does not include process connector)
23765-00	1¼-in. ball valve kit assembly, 316 stainless steel (does not include process connector)
24281-00	15-ft. (4,6 m) cable with mating VP8 connector
24281-01	25-ft. (7,6 m) cable with mating VP8 connector
24281-02	2.5-ft. (0,8 m) cable with mating VP8 connector
24281-05	4-ft. (1,2 m) cable with mating VP8 connector
24281-06	10-ft. (3 m) cable with mating VP8 connector
24281-07	20-ft. (6,1 m) cable with mating VP8 connector
24281-08	30-ft. (9,1 m) cable with mating VP8 connector



EMERSON AUTOMATION SOLUTIONS

6021 Innovation Blvd.
Shakopee, MN 55379

 +1 866 347 3427

 +1 952 949 7001

 RMTNA.RCCPO@Emerson.com

NORTH AMERICA

Emerson Automation Solutions
8200 Market Blvd
Chanhassen, MN 55317

 Toll Free +1 800 999 9307

 F +1 952 949 7001

 RMTNA.RCCPO@Emerson.com

EUROPE

Emerson Automation Solutions
Neuhofstrasse 19a PO Box 1046
CH-6340 Baar
Switzerland

 +41 (0) 41 768 6111

 +41 (0) 41 768 6300

 RMTNA.RCCPO@Emerson.com

MIDDLE EAST AND AFRICA

Emerson Automation Solutions
Emerson FZE
Jebel Ali Free Zone
Dubai, United Arab Emirates, P.O. Box
17033

 +971 4 811 8100

 +971 4 886 5465

 RMTNA.RCCPO@Emerson.com

ASIA-PACIFIC

Emerson Automation Solutions
1 Pandan Crescent
Singapore 128461
Republic of Singapore

 +65 6 777 8211

 +65 6 777 0947

 RMTNA.RCCPO@Emerson.com

 [LinkedIn.com/company/Emerson-Automation-Solutions](https://www.linkedin.com/company/Emerson-Automation-Solutions)

 [Twitter.com/rosemount_news](https://twitter.com/rosemount_news)

 [Facebook.com/Rosemount](https://www.facebook.com/Rosemount)

 [Youtube.com/RosemountMeasurement](https://www.youtube.com/RosemountMeasurement)

©2020 Emerson. All rights reserved.

The Emerson logo is a trademark and service mark of Emerson Electric Co. Rosemount is a mark of one of the Emerson family of companies. All other marks are the property of their respective owners.