

Rosemount™ SAM42 Acoustic Particle Monitor

Non-intrusive Sand Monitoring

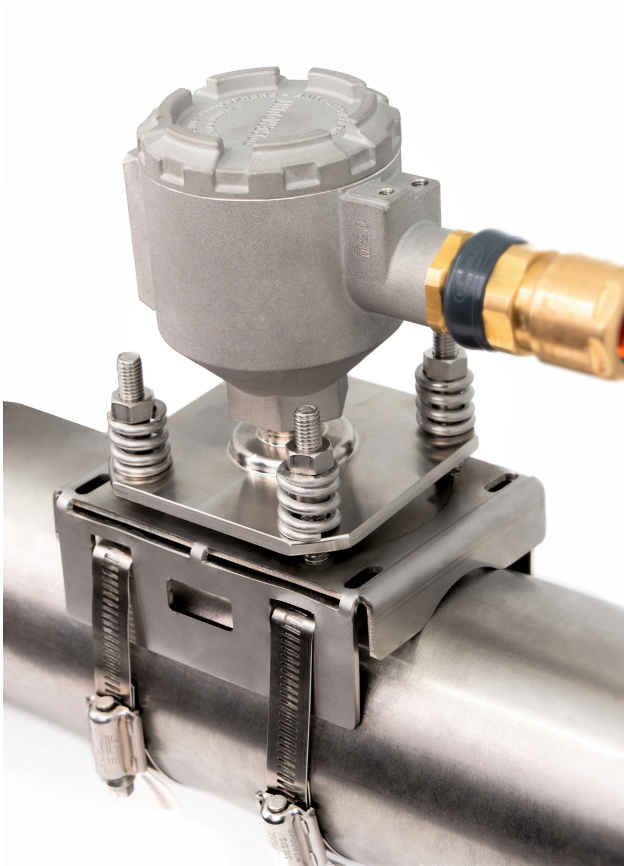

Safety messages

NOTICE

Read this guide before working with the product. For personal and system safety, and for optimum product performance, make sure to thoroughly understand the contents before installing, using, or maintaining this product. If the equipment is used in a manner not specified by the manufacturer, the protection provided by the equipment may be impaired.

The United States has two toll-free assistance numbers and one international number:

Customer Central: +1 800 999 9307 (7:00 a.m. to 7:00 p.m. CST)

National Response Center: +1 800 654 7768 (24 hours a day) Equipment service needs

International: +1 952 906 8888

⚠ WARNING

Explosions

Failure to follow these installation guidelines could result in death or serious injury. Explosions could result in death or serious injury.

Installation of this transmitter in an explosive environment must be in accordance with the appropriate local, national, and international standards, codes, and practices. Review the approvals section of this Quick Start Guide for any restrictions associated with a safe installation.

Before installation, configuration and commissioning the device in a hazardous area, make sure the necessary permits have been obtained in accordance with site safe practices.

Conduits/cable entries

For general use, conduit is not required for SAM42.

Only use adapters, glands, or conduit with a compatible thread form when closing entry. Entry marked M20 is M20 x 1.5 thread form.

When installing in a hazardous location, use only appropriately listed or Ex-certified cables, glands and adapters in cable/conduit entry. If not sourcing the field cable from Emerson, ensure the selection is suitable for the location (including protection type) and maximum expected ambient temperature.

Wiring must comply with the appropriate local standards. For North America, cables must comply with UL 44 or UL 88 / CSA C22.2 No. 75.

Physical access

Unauthorized personnel may potentially cause significant damage to and/or misconfiguration of end users' equipment. This could be intentional or unintentional and needs to be protected against.

Physical security is an important part of any security program and fundamental to protecting your system. Restrict physical access by unauthorized personnel to protect end users' assets. This is true for all systems used within the facility.

⚠ CAUTION

Caution:

Do not open when explosive atmosphere is present.

Attention:

Ne pas ouvrir en présence d'une atmosphère explosive.

The products described in this document are not designed for nuclear-qualified applications.

Using non-nuclear-qualified products in applications that require nuclear-qualified hardware or products may cause inaccurate readings.

For information on Rosemount nuclear-qualified products, contact an Emerson sales representative.

Note: The equipment is designed to be installed in an area of up to and including Pollution Degree 4.

Contents

Overview..... 5

Preparing for installation..... 9

Physical installation of the device..... 15

Configuration and commissioning Rosemount SAM42 Acoustic Particle Monitor..... 34

Setting alarms..... 57

Rosemount SAM42 Acoustic Particle Monitor in operation..... 61

Reference information..... 67

Maintenance of Rosemount SAM42 Acoustic Particle Monitor.....70

Product certifications..... 74

Declaration of Conformity..... 78

1 Overview

This guide provides basic guidelines for the installation, configuration, commissioning, operation and maintenance of the Rosemount SAM42 Acoustic Particle Monitor. This guide is also available electronically at [Emerson.com/Rosemount](https://www.emerson.com/Rosemount).

The SAM42 Acoustic Particle Monitor is a non-intrusive sand monitoring system that measures in real time the amount of solid particles in oil, gas or multiphase flow lines.

This device is designed to be installed in hazardous area locations. The device has options for Explosion proof (Ex-d) protection or Intrinsically Safe (Ex-ia) protection available. As the operational temperature of the piping which the device may be mounted on can vary, there is a Standard Temperature (ST) version which can operate up to 266 °F (130 °C) and a High Temperature (HT) version which can operate up to 554 °F (290 °C). Both versions are available in either Ex-d or Ex-ia protection methods. [Figure 1-1](#) details the main components of a SAM42 Acoustic Particle Monitor.

For detailed product specifications and performance, refer to [Rosemount SAM42 Acoustic Particle Monitor Product Data Sheet](#).

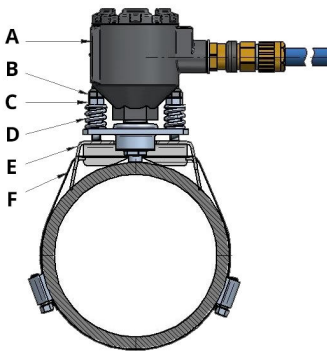
Figure 1-1: SAM42 Acoustic Particle Monitor**Mounting > NPS 2**

- A. SAM42 Transmitter
- B. Locking nut
- C. Compression nut
- D. Loading spring
- E. Mounting socket
- F. Strapping

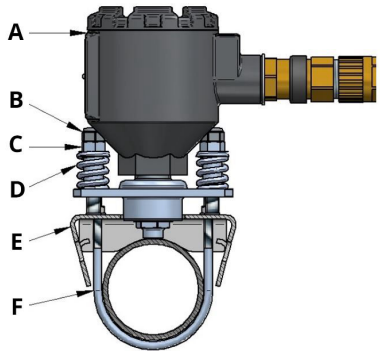
Mounting NPS 2

- A. SAM42 Transmitter
- B. Locking nut
- C. Compression nut
- D. Loading spring
- E. Mounting socket
- F. U-bolt

1.1 What's in the box?

The device is delivered in a cardboard box containing:

- 1 x Rosemount SAM42 Acoustic Particle Monitor
- 1 x Mounting socket
- 1 x Mounting strap kit (or U-bolts)
- 1 x Loctite 5990
- 1 x Cable gland (if selected)
- 1 x Safety barrier (Ex-ia only, and if selected)
- 1 x Paper copy of this guide

Note

The Rosemount SAM42 Acoustic Particle Monitor and mounting socket will vary between a standard or high temperature variants, this is dependent on the selection made on the order model. Mounting hardware will be dependent on the model code which is ordered. If mounting on NPS 2 then, U-bolts will be supplied with the product. If > NPS 2 then, strapping will be supplied with the product.

Field cable is not supplied with the product as standard. Field cable is orderable and supplied separately to the device.

1.2 Required tools and equipment for installation

This section lists the required tools and equipment for physical installation, configuration and commissioning of the Rosemount SAM42 Acoustic Particle Monitor.

1.2.1 Configuration and commissioning

The Rosemount SAM42 Acoustic Particle Monitor must be configured before physical installation. Direct configuration must be performed using a Windows™ laptop or tablet with the SAM42 Commissioning app installed.

- Computer or tablet running Windows
- USB to RS 485 Converter
- SAM42 Commissioning app

Note

If using a tablet or laptop in the hazardous area, ensure that the correct permits are applied and granted before carrying out any of the work.

SAM42 Commissioning App is available for download on [Emerson Software Application Portal](#).

USB to RS 485 Converter is included in the installation kit that is available for purchase upon request. Typically, one installation kit per site should suffice.

1.2.2 Physical installation

The tools required for mounting the device in the field are the following:

- Tinsnips
- Screwdriver, flathead
- Spanner, 13 mm
- Spanner, custom to fit device lid, nut height gauge also built in
- Socket, 8 mm, ¼-in. drive
- Torque wrench ¼-in. drive, 2.5 N-m to 15 N-m
- Allen key, 3 mm
- Sandpaper (grade 60-100)/ wire brush for sensitivity testing
- Flat file, 250 mm

- Wire brush, brass, 25 mm
 - Cable stripping knife (for removing insulation of cable)
 - Side cutters (to cut cable to correct length)
-

Note

The tools above are included in the Installation kit Extended version – that is available for purchase upon request. Typically, one installation kit per site should suffice.

2 Preparing for installation

2.1 Preparation at location of installation

Before proceeding to install and commission the Rosemount SAM42 Acoustic Particle Monitor, ensure the following have been completed:

Procedure

1. Identify the location where the monitor will be installed.
This would typically be between 30 cm – 100 cm (75 cm recommended) after a 90° bend; on the outside of the bend.
2. Ensure all cladding and insulation has been removed around the circumference of the pipe at the sensor location.

The dimension drawing in [Figure 2-1](#) provides guidance on how the device will be installed on the pipe. It is suggested that a length of 20 in. (0.5 m) is removed.

Note

Cladding or insulation can be replaced after the monitor installation has been completed, provided that the head of the sensor remains outside the insulation. Insulation materials can be insulated around the sensor as desired and according to local procedures.

Figure 2-1: Installation diagram of SAM42 Acoustic Particle Monitor

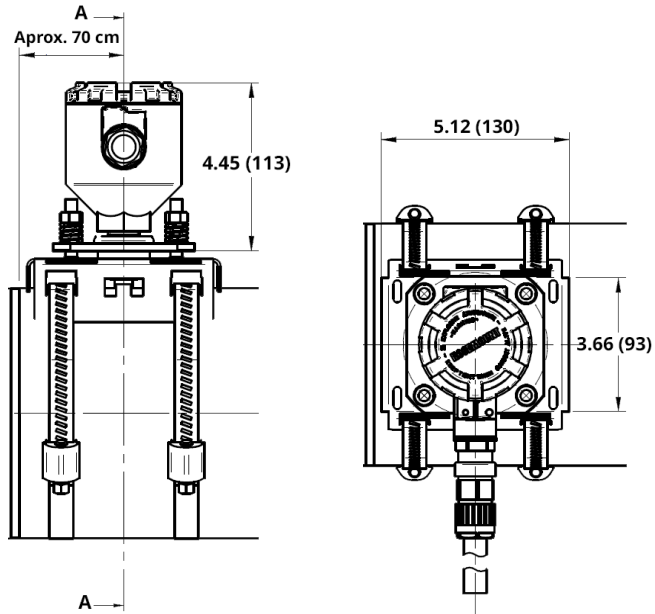

Dimensions are in inches (millimeters).

2.2 Device ID configuration

Rosemount SAM42 Acoustic Particle Monitor will have the device ID set to 1 by default. When installing multiple devices on the same bus, change/configure the devices so that they have a unique ID, as not to be confused later.

It is recommended that this is done in a safe area, using the configuration cable prior to being installed in the field. To complete this phase, follow the process below:

Procedure

1. Remove the lid of the SAM42 Acoustic Particle Monitor and connect the configuration cable to the socket of the device.



2. Connect the configuration cable to the tablet or PC which will be running the commissioning application.
3. Open the commissioning application.

The window below will appear:

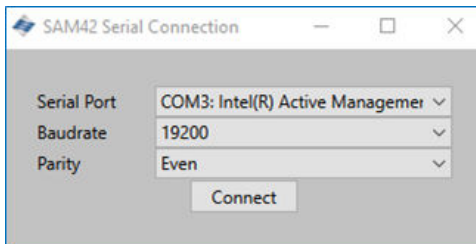

- a. Select the correct serial port (which can be found in device manager).
- b. Baud rate needs to remain at **19200**.
- c. Parity needs to remain **Even**.
- d. Press **Connect**.

- 4. The window showing connection to the SAM42 Acoustic Particle Monitor has been established will appear.

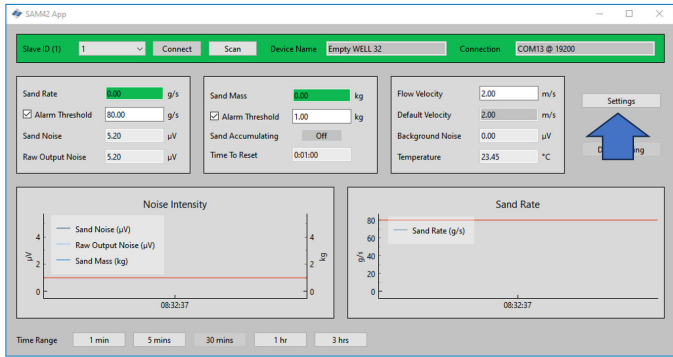

Note

This is the home window which will show the operational status of the monitor.

- a. From this window, press the **Settings** button to go to the **Settings** window.

5. In the **Settings** window as shown below, the name of the device may be set.

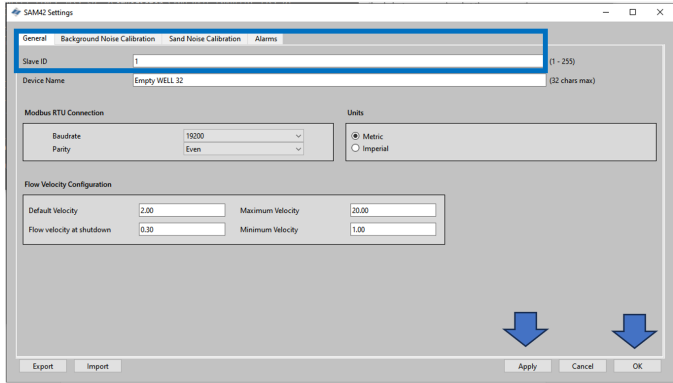

- a. In the **Slave ID** field, enter a unique ID which should be different to the other devices which are being installed/are installed.
This is a numeric only field with a value between 1 – 247.
- b. In the **Device Name** field, enter a meaningful device name which can be used to identify the device.
This field is limited to 32 characters.
- c. Once entered, press **Apply** to write this to the device.
- d. Press **OK** to return to the home screen.

- 6. In returning to the home screen, connection to the device will be lost. Follow the steps below to reestablish communication with the device.

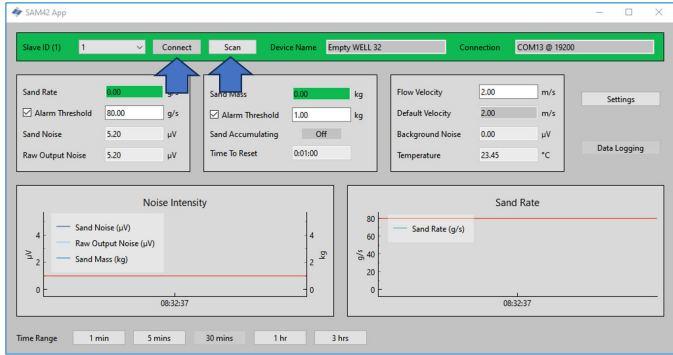

- a. Press the **Scan** button, then the application will look for all available ID's.
- b. Using the **ID** dropdown list, select the ID previously created.
- c. Press the **Connect** button to reestablish communication with the device.

3 Physical installation of the device

This chapter contains information on physical installation of the Rosemount SAM42 Acoustic Particle Monitor, assuming that field cabling is already in place. This section also describes the differences in the installation of the Standard Temperature (ST) and High Temperature (HT) variants.

The SAM42 Acoustic Particle Monitor is mounted externally on the pipeline and acts as microphone in the ultrasonic frequency range, picking up ultrasonic noise induced by particle impingement or scouring against the inside pipe wall.

Note

Always ensure that the equipment's Ex classification follows the hazardous area in which it is to be installed. Pay close attention to the special installation requirements for safe use. Note that the Ex-classification marking must be visible for inspection after installation.

Related information

[Installing mounting socket onto the pipe with strapping for pipes > NPS 2](#)

[Installing Rosemount SAM42 Acoustic Particle Monitor on small diameter pipes \(NPS 2\) using U-bolts](#)

[Installing the Rosemount SAM42 Acoustic Particle Monitor onto the mounting socket](#)

3.1 Temperature considerations

Consideration should be given to the suitability of installing a SAM42 device given the expected maximum ambient temperature, the maximum process temperature and the temperature class of the explosive gasses expected at each installation location. The permitted envelope of conditions for the Standard Temperature device is shown in [Figure 3-1](#) and for the High Temperature device is shown in [Figure 3-2](#).

Figure 3-1: SAM42 Standard Temperature Operating temperature limits

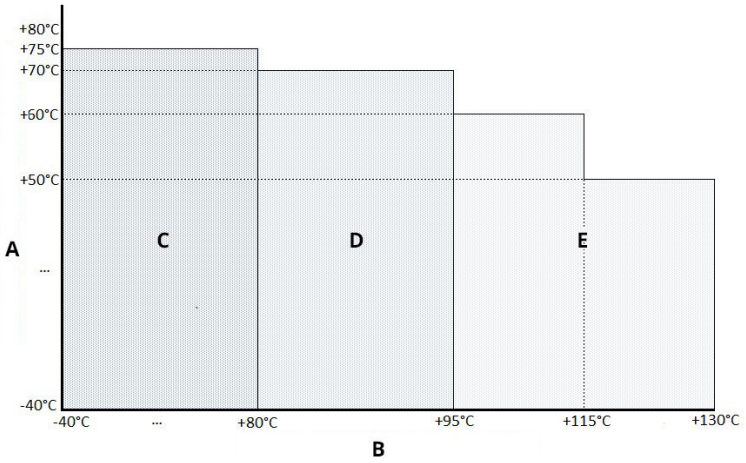

- A. *Maximum permitted ambient temperature*
- B. *Maximum permitted process temperature*
- C. *T6*
- D. *T5*
- E. *T4*

Figure 3-2: SAM42 High Temperature Operating temperature limits

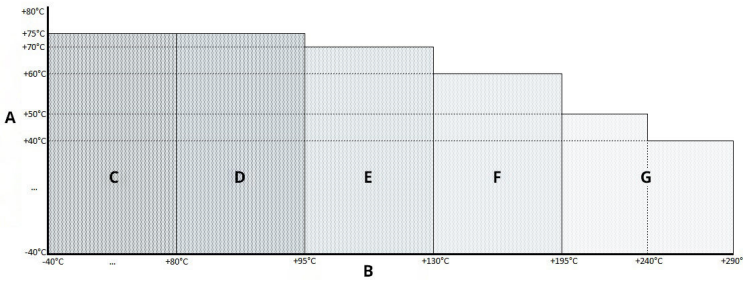

- A. Maximum permitted ambient temperature
- B. Maximum permitted process temperature
- C. T6
- D. T5
- E. T4
- F. T3
- G. T2

3.2 Installation location for Rosemount SAM42 Acoustic Particle Monitor

This section details how to install the device onto piping.

ST version up to 266 °F (130 °C) — Ensure there is a space between the detector housing and any pipe insulation to allow the heat to dissipate from the detector and the pipe. This space ensures the detector's temperature is kept as low as possible. See [Figure 3-3](#). For pipe surface temperatures > +176 °F (+80 °C) it is recommended to mount the detector either horizontally (as shown in [Figure 3-4](#)) or below the pipe.

HT version up to 554 °F (290 °C) — Ensure there is a space between the detector housing and any pipe insulation to allow the heat to dissipate from the detector and the pipe. This space ensures the detector's temperature is kept as low as possible. The device must always be mounted either horizontally (as shown in [Figure 3-4](#)) or below the pipe.

Consideration should be given to the suitability of installing a SAM42 device given the expected maximum ambient temperature, the maximum process temperature and the temperature class of the explosive gases expected at each installation location. Recommended and unsuitable combinations of conditions are shown for the

Standard Temperature device in [Figure 3-3](#) and for the High Temperature device in [Figure 3-4](#).

3.2.1 Standard temperature Rosemount SAM42 Acoustic Particle Monitor location

Procedure

To achieve best sensitivity, the Rosemount SAM42 should be installed downstream from and as close as possible to a 90° bend and not further away than 75 cm. Care should be taken to avoid installation near known sources of unwanted noise such as choke valves or cyclonic de-sanding equipment. Excessive levels of unwanted noise may compromise the measurement principle. See [Figure 3-3](#).

Figure 3-3: Illustration of SAM42 Acoustic Monitor installation on a pipe

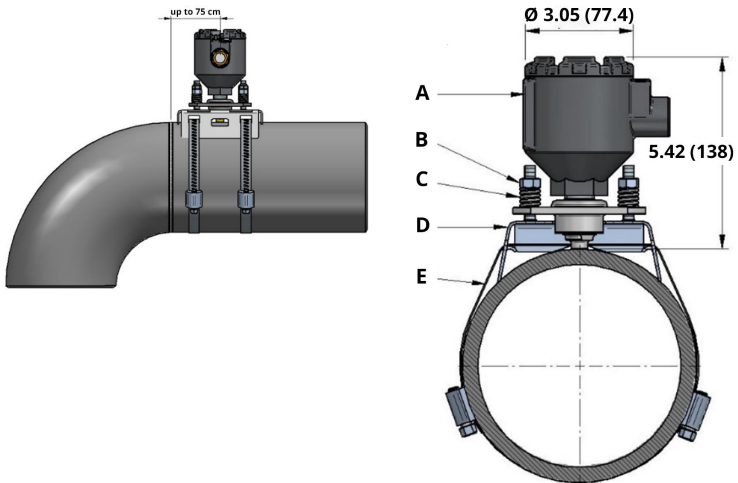

- A. Detector housing
- B. Fixing bolts & nuts
- C. Loading springs
- D. Mounting socket
- E. Mounting strap

Dimensions are in inches (millimeters).

3.2.2 High Temperature Rosemount SAM42 Acoustic Particle Monitor Location

The same installation methods can be used as described in [Standard temperature Rosemount SAM42 Acoustic Particle Monitor location](#) when installing SAM42 HT version. However, additional consideration is needed when choosing the mounting orientation due to the higher process temperatures. It is suggested the device be mounted horizontally (3 o'clock or 9 o'clock) or in some cases at the base (6 o'clock) to minimize convective heat transfer from the pipe to the sensor. See [Figure 3-4](#).

Figure 3-4: Illustration of mounting a high temperature device

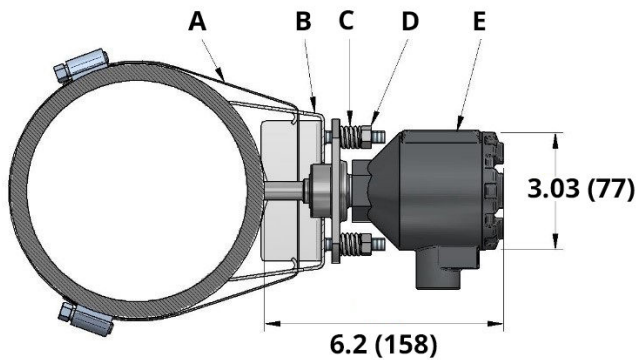

- A. Mounting strap
- B. Mounting socket
- C. Loading springs
- D. Fixing bolts & nuts
- E. Detector housing

Dimensions are in inches (millimeters).

3.3 Surface preparation

Before mounting the Rosemount SAM42 Acoustic Particle Monitor, ensure the surface of the pipe has been prepared so that the device has optimal contact with the pipe surface. Using a flat file, wire brush or sandpaper, ensure that a 25 mm x 25 mm square section of the surface of the pipe is:

- Bare metal (no coatings etc.)
- Free of debris

3.4 Installing mounting socket onto the pipe with strapping for pipes > NPS 2

This section describes how to install the mounting socket for the Rosemount SAM42 Acoustic Particle Monitor onto pipe work. Follow the sequence detailed below for a successful installation:

Note

The same mounting socket is used on all pipe diameters from NPS 2 to NPS 48.

Procedure

1. Place the mounting socket on the pipe. The wings of the mount should be in contact with the pipe. If the wings are not in contact with the pipe, then manually adjust as necessary.

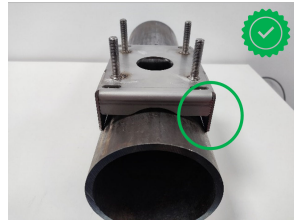
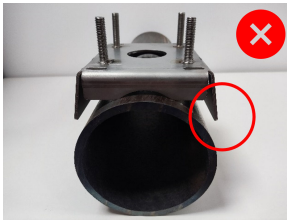

2. Feed two lengths of strap though the mounting socket. Ensure the lengths are equal when they have passed through the mount.

It is recommended the mount is then placed on the pipe. Wrap the strapping around the pipe so that excess strapping can be cut off to make the mounting easier.

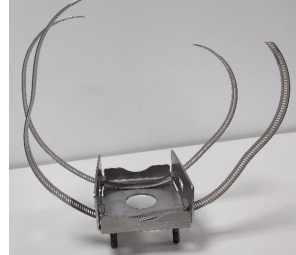
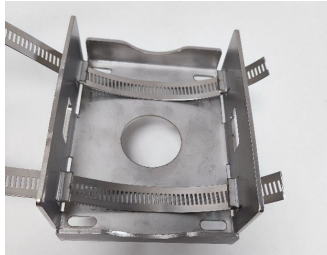

⚠ CAUTION

The cut ends of the strapping may be sharp. Take care when handling the ends of the strapping. Gloves should be worn to prevent cuts from the sharp ends of the strapping.

3. Insert one of the ends of the strap into the worm drive and tighten until the strap becomes visible through the other side of the worm drive. Repeat with the second strap.

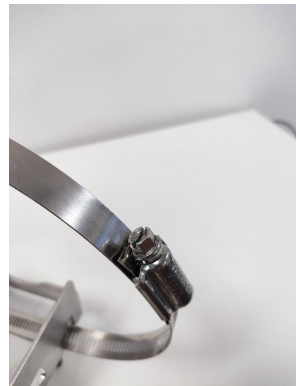

4. Place the mount onto the pipe surface, with the straps wrapping around the pipe. Insert the free end of the strap into the free worm drive and tighten to a torque detailed below.

This needs to be repeated for both straps. This is done by using the torque wrench and 8 mm socket.

NPS > 2 to NPS 12	5 N-m
NPS 12 to NPS 48	15 N-m

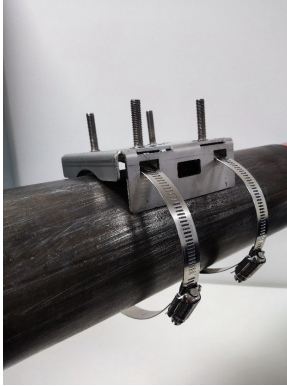

Note

When torquing the worm drives, ensure that the band which has the two worm drive band mounted remains opposite to the device. Refer to [Figure 3-5](#). Once the straps have been torqued, cut any excess strapping using the tinsnips.

Figure 3-5: Ideal location of the worm drive band



3.5 Installing Rosemount SAM42 Acoustic Particle Monitor on small diameter pipes (NPS 2) using U-bolts

For installing on small diameter pipes, U-bolts replace the strapping which is normally used. This section describes the installation using U-bolts rather than strapping. This can be applied to both the standard temperature and high temperature variants of the product.

Procedure

1. Place the mounting socket on the pipe. The wings of the mount will not be in contact with the pipe. The wings must be bent in so that they are parallel to the pipe.



2. Place the U-bolt around the pipe and feed the ends into the holes which are in the mounting socket.



3. Add a washer and nut to the U-bolt and tighten until hand tight. Now, torque the nuts on the U-bolts to 3 N-m. This must be done a ¼ of a turn at a time until all nuts have reached 3 N-m.

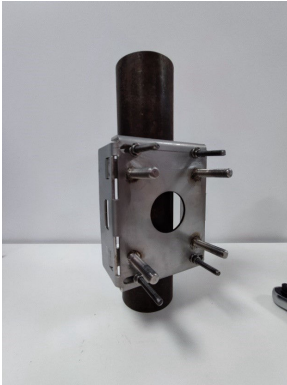

Once the installation of the mount on a small pipe has been completed, proceed to [Installing the Rosemount SAM42 Acoustic Particle Monitor onto the mounting socket](#) to install the device on the mounting socket.

3.6 Installing the Rosemount SAM42 Acoustic Particle Monitor onto the mounting socket

This section describes the process of installing the SAM42 Acoustic Particle monitor onto the mounting socket to ensure that it functions correctly.

Procedure

1. Place some Loctite 5990 onto the tip of the SAM42 Acoustic Particle Monitor.



2. Place the device onto the mounting socket, ensuring that the studs of the mounting socket pass through the holes on the flange of the device. Push the device until the waveguide makes contact with the pipe and check that the Loctite 5990 has spread out evenly.

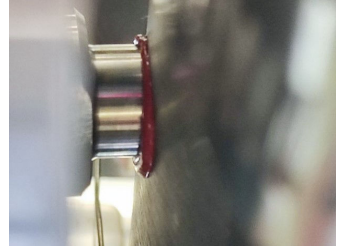

3. Place a spring followed by a nut onto each of the four studs. Then, tighten the nuts until they are touching the top of the springs.

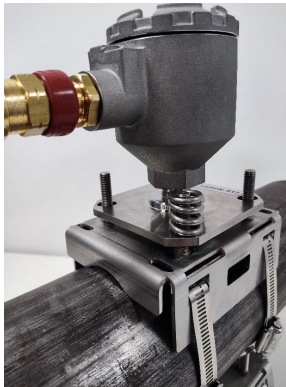

Note

When tightening the nuts, ensure that the flange remains parallel to the mounting socket on all sides. This will ensure that the waveguide of the sensor is flush against the measurement surface.

4. Tighten the nuts as follows:
 - a. Using cross-tightening, tighten the nuts onto the studs.
 - b. Tighten each nut in $\frac{1}{2}$ turn steps.
 - c. Complete four complete rotations.
 - d. Check using height gauge.
 - e. Repeat until gauge legs are touching the flange, and in contact with the top of the nut.

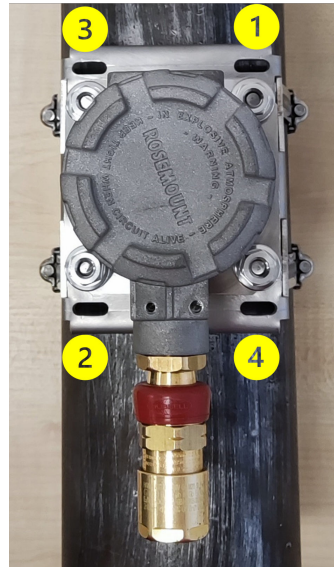
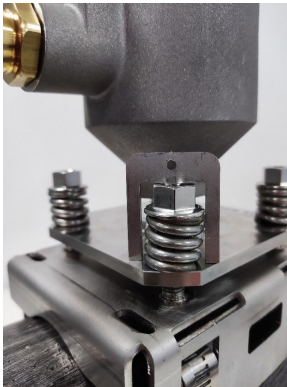
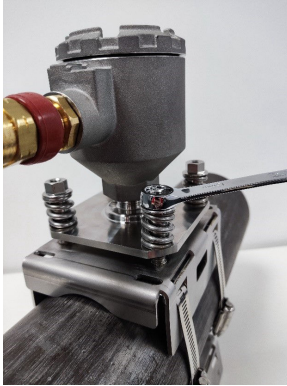

⚠ CAUTION

When tightening the nuts and compressing the springs, be careful not to get clothing or body parts caught as there is a possibility that they could become caught and damaged in the springs.

Note

When tightening the nuts onto the studs, ensure that the flange remains parallel to the mounting socket. This will ensure that the waveguide of the sensor is flush against the measurement surface.

5. Once the gauge fits as described, re-check the following:
 - a. The flange is parallel to the mounting socket on all sides.
 - b. The waveguide contact with the pipe is flush.

If this is the case, add the locking nuts onto the studs and tighten using two spanners.



3.7 Cabling into the Rosemount SAM42 Acoustic Particle Monitor

This section describes the process of cabling into the device. To complete this successfully, follow the process detailed below.

Note

Before wiring the device, review the electrical considerations. When routing the cable to the device, ensure that the following considerations are taken into account:

- The cable is not making contact with the pipe or hot surfaces.
 - The cable is not bent above its minimum bend radius.
 - The necessary strain relief has been deployed.
-

3.8 Electrical requirements

Mounting the detector on the pipe

- See [Temperature considerations](#) for restrictions to ambient and pipe surface temperatures.
- The sensor shall have galvanic contact with the pipe connected to PE earth. No paint is allowed at the area of contact.
- The detector housing and mounting socket shall also be connected to PE earth; either directly through the structure by removing paint at the area of contact between socket and pipe, or by other means – e.g., through cable armor (refer to [Figure 6-1](#)). Housing and clamp are in galvanic contact with each other, but not with the sensor.

Field cable and cable termination

- The recommended field cable for Rosemount SAM42 Ex d version is 20110626 BFOU(I) M 250V: Shielded twisted two pairs (one pair for power and one for signal), wire cross-section 0.75 mm², L/R = 87 μH/ohm (max). Color: grey.
- The recommended field cable for Rosemount SAM42 Ex ia version is 20104969 BFOU(I) M 250V: Shielded twisted two pairs (common pair for power and signal), wire cross-section 0.75 mm², L/R = 87 μH/ohm (max). Color: blue.
- For Ex-d system, the maximum cable length is 1200 m. This is limited by use of RS485 communications.
- For Ex-ia systems, the maximum cable length shall be determined by the installer based upon site requirements (gas group etc.) and electrical characteristics of the SAM42 device, connecting cable and communications and power barriers used.
- Note that cables for intrinsically safe apparatus shall be clearly marked and be clearly identifiable.
- For installations Ex-d, the cable screen shall be connected to PE earth in the safe area but always left floating on the detector side.
- For installations with IS earth, the cable screen shall be connected to IS earth in the safe area but always left floating on the detector side.
- If the detector housing and mounting socket is not in galvanic contact with the pipe structure, grounding to PE earth must be by other means, e.g., by terminating the cable armor to the detector housing and grounding the armor in the safe area. The cable armor may be terminated within the gland assembly.

Installation with IS earth – connection via shunt-diode safety barrier

- A suitable shunt-diode safety barrier is selected on the basis of gas group compliance (IIB) and loop calculations. The entity parameters for safety barrier and load (voltage, current, capacitance and inductance) must match up correctly in order for the loop to be approved intrinsically safe.
- MTL7787+ is an example of a suitable shunt-diode safety barrier, with $U_{\max} = 28 \text{ V}$, $I_{\max} = 93 \text{ mA}$, $R_{\min} = 300 \text{ ohm}$. Refer to [Figure 6-5](#).
- The earth terminal of the safety barrier shall be connected to IS earth.
- The safety barrier is normally mounted on a DIN rail connected to the Intrinsically Safe (IS) earth.
- The cable screen shall be connected to IS earth in the safe area but always left floating on the detector side.

Installation without IS earth-connection via galvanic isolated safety barrier/current repeater

- If no IS earth is used, the detector may be connected via a galvanic isolating safety barrier. A suitable barrier is selected on the basis of gas group compliance (IIB) and loop calculations. The entity parameters for safety barrier and load (voltage, current, capacitance and inductance) must match up correctly in order for the loop to be approved intrinsically safe.
- MTL5541 is an example of a suitable galvanic isolated barrier, with $U_{\max} = 28 \text{ V}$, $I_{\max} = 93 \text{ mA}$, $R_{\min} = 300 \text{ ohm}$. Refer to [Figure 6-5](#).

3.8.1 Checking the setting of RS485 termination resistor with dip switches

Check that the dip switches are set correctly. For normal operation, make sure that the switches are in the 'open' (fully down) position as shown in [Figure 3-6](#). If switch number two is set to 'closed' (up) position, the device connects the 120Ω termination resistor to the RS485 loop.

Figure 3-6: RS485 termination resistor

3.8.2 Earthing and cable screening

The SAM42 is a very sensitive acoustic noise detection device. The noise generated by the sand hitting the metal pipe is what the SAM42 uses to estimate sand production. Unfortunately, there are other noise sources that might have a negative impact on the sand measuring performance.

For the best noise rejection performance, the electronics inside the SAM42 enclosure are isolated from the enclosure itself.

The SAM42 may be located in a noisy environment (electrical noise). In order for this electrical noise not to interfere with the measurement capabilities of the device, certain measures should be implemented:

- The cable shield should be terminated inside the gland. The shield will then connect to the SAM42 enclosure through the gland.
- A galvanically isolated RS485 adapter should be used to avoid creating ground loops.
- In order to avoid ground loops, the complete system should be connected to PE in only one point. If the pipes are connected to earth, then there is no need for any extra earth connection. If the pipes are not connected to PE or if the connection is poor, then the sensor's enclosure should be grounded (PE). Each installation has its own particularities but noise issues can be avoided by following the simple steps described above.

3.8.3 Cabling the device

Procedure

1. Wire in the Ex-d or Ex-ia cable into the cable gland as per instructions provided by the gland manufacturer. Allow 25 cm of conductors exiting the gland for easy wiring into the device.



2. Feed the wires through the device housing. Tighten the gland onto the housing until it is in full contact with the device housing. Using a 24 mm spanner, ensure that the gland is tightened fully in accordance with the manufacturer's instructions.



3. Remove the connector from the socket inside the device. Connect the four conductors into the connector ensuring that they match the power and data connections from the control system side. The connections from left to right are: Communication -ve, Communication +ve, Power -ve, Power +ve.

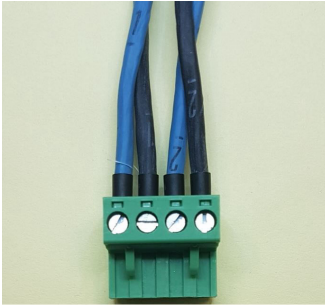

4. Insert the connector into the socket in the device with the excess wire looped around the inside of the device housing.



5. Replace the lid on to the housing of the device. Using the lid spanner, tighten the lid until the lid cannot be tightened further (the lid should ground out on the device housing).

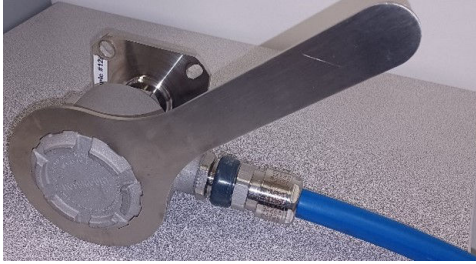

The Rosemount SAM42 Acoustic Particle Monitor is now installed onto the pipe surface. The next task is to commission and calibrate the device for use. Refer to [Configuration and commissioning Rosemount SAM42 Acoustic Particle Monitor](#) for more information.

4 Configuration and commissioning Rosemount SAM42 Acoustic Particle Monitor

This section details how to commission the device. This includes carrying out background noise calibration, sand injection calibration and setting alarms.

4.1 Connecting to the device and commissioning homescreen

Procedure

1. Connect to the device to the commissioning device (RS485 converter) and connect to a PC or Tablet which has the commissioning app installed.
2. Open the commissioning app.
3. Select the COM port to which the converter is assigned (Device manager can be used to identify the COM port). Baud rate should be **19200**, Parity should be **Even**.
4. Then, press **Connect**.

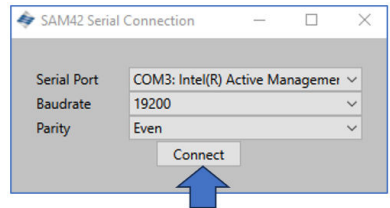

- Once connection has been established, the application home screen will display general information for the device. The measurement information (sand noise/raw output noise) will refresh every second.

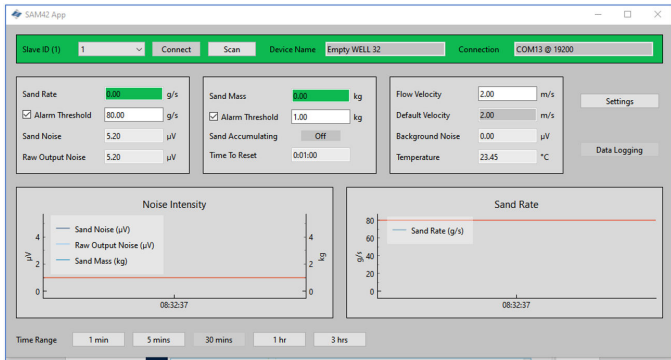

4.2 Calibration strategy

The calibration method to be used should be agreed in advance of any commissioning work.

The purpose of the calibration is to establish the relation between flow noise and velocity (i.e., the background noise function) and the sand induced noise and velocity (i.e., the sand noise function).

The calibration strategy is dependent on the end user requirement for accuracy and sand management philosophy. There are normally three different approaches to operate the Rosemount SAM42 Acoustic Particle Monitor.

Sand detection

This method requires no calibration and no velocity input. When observing abnormal signal behavior compared to stable background signal, this will indicate that the well is producing sand. Trending of raw data and manual interpretation of this data is required, unless a threshold alarm level is defined in the DCS/PCS.

Sand indication

This method requires background noise calibration and velocity input. The sand calculation will be based on default factory calibration curves. The system output will give a rough estimation of sand rate. One point calibration as described in [Background noise calibration of the device](#) can be performed to decrease the measurement uncertainty.

Sand monitoring

To be able to achieve this calibration strategy, the use of a sand injector skid is required. This method requires both background and sand injection calibration, together with velocity input. Calibration curves will be adjusted to meet the well properties over a defined velocity range.

4.3 Background noise calibration of the device

Procedure

1. To complete background noise calibration, it is recommended that a minimum of three measurements are taken. These measurements would be made at the minimum expected flow velocity of the asset, the maximum expected flow velocity of the asset. Additional measurements can be taken to improve the calibration with the flow velocities being in the expected operating range of the asset.
2. From the commissioning home screen, press the **Settings** button.

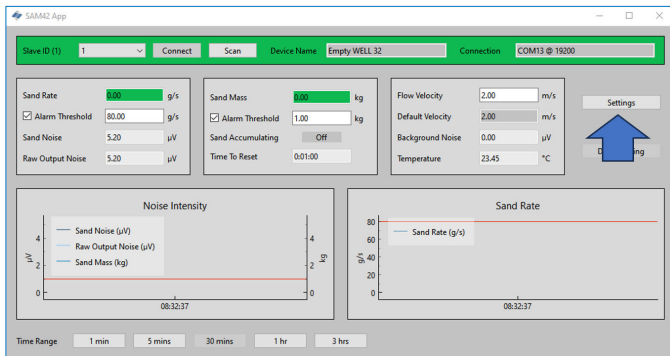

- 3. In the **Settings** window, click the **Background Noise Calibration** tab to bring up the **Calibration** window.

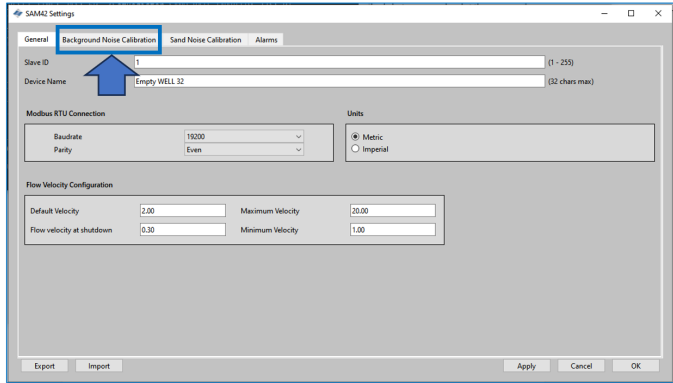

- 4. The **Background Noise Calibration** window will open. Fill out the table on the left-hand side of the window. This can be completed in two different ways:
 - a. [Preferred] Using the measure function on this tab by pressing the **Measure** button below the table on the left-hand side of the window.
 - b. [Optional] Using manual data entry.

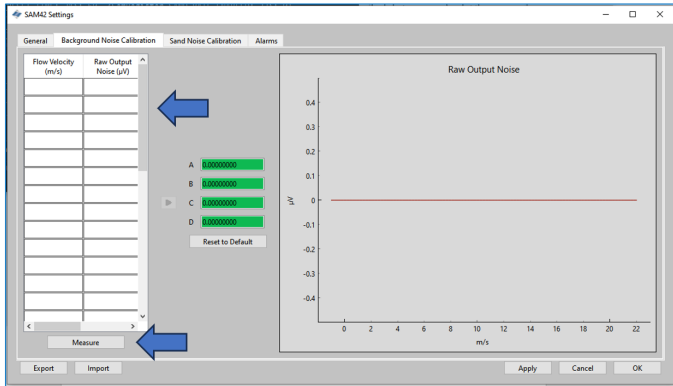

4.3.1 Calibration using measure function

Procedure

1. Press the **Measure** button.

The **Background Noise Calibration** window will open.

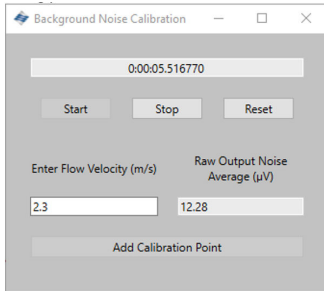

2. Enter the velocity for the first measurement. This value is in meters per second (m/s).

Once the flow velocity for the test has been entered, press the **Start** button to commence the recording for the calibration.

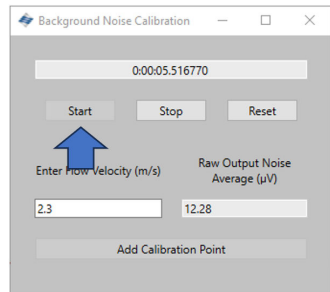
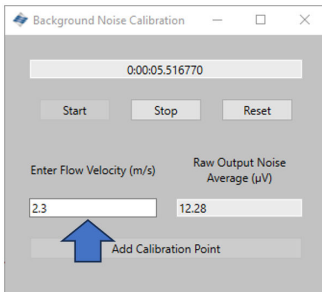

- Record for 1 – 2 minutes to ensure that a representative average can be taken. Once the timer has reached this value, press **Stop** which will halt the data collection, leaving an average noise output for the recording.

To register this value in the calibration table, press **Add Calibration Point**.

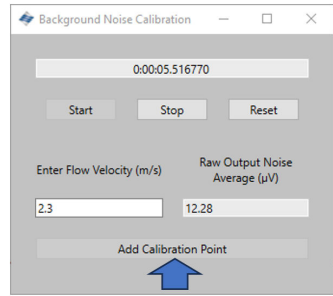
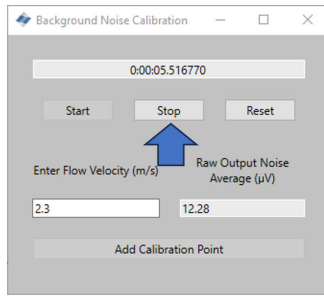

- Press **Reset**. Then, repeat this process for the remaining points so that data for at least three velocities is collected.

Once all the data has been collected, return to the **Calibration** window by closing the **Background Noise Calibration** window.

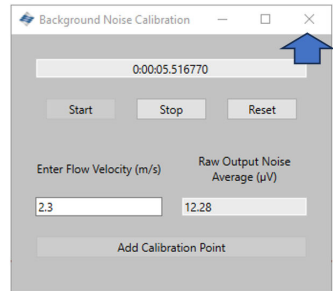
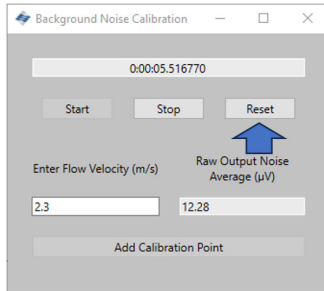

- 5. The table on the left-hand side of the **Background Noise Calibration** tab will now be filled with the selected velocities and the average noise outputs.



- 6. Once the values have been generated, press the grey arrow (▶) to generate the calibration coefficients for the device.

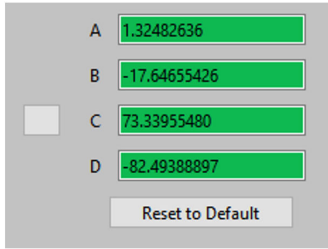
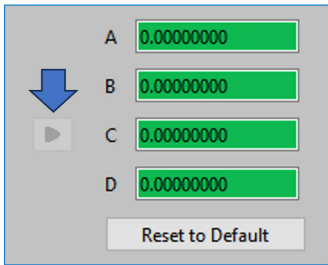

- 7. This will also generate a polynomial curve which can be seen on the graphing interface displayed on the right-hand side of the calibration window. Check the measurement points sit on the curve or are very close to the created curve. If there are any outliers, then the measurement will either need to be discarded or re-measured.

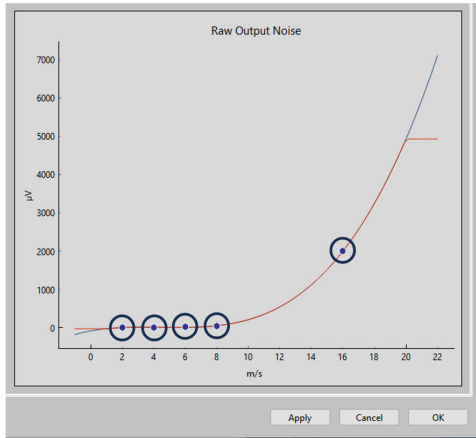

- 8. Once the curve is satisfactory, press **Apply**. The calibration coefficients will be written and stored on the device, to be used when in operation to remove the background noise from the impact noise.

The SAM42 Settings window has tabs for "General", "Background Noise Calibration", "Sand Noise Calibration", and "Alarms". The "Background Noise Calibration" tab is active, showing a table of flow velocity and raw output noise, a list of coefficients (A, B, C, D), and the "Raw Output Noise" graph. A blue arrow points to the "Apply" button.

Flow Velocity (m/s)	Raw Output Noise (µV)
2	6
4	7
6	16
8	50
16	2000

Calibration Coefficients:

- A: 1.2040493E
- B: 1.1766656E8
- C: 3.1399568E
- D: 62.49388997

Buttons: Measure, Export, Import, Apply, Cancel, OK

- 9. To exit the **Background Noise Calibration**, press **OK** to return to the home screen.

At this stage, the background noise calibration for the device has been completed. There are some additional features on the background noise calibration window which can be used:

- **Export**
Once calibration has been completed, the calibration data and coefficients from the application may be exported. This will be in the form of a `.SAM42` file. Press the **Export** button in the bottom left-hand corner of the window to store this file for future use.
- **Import**
Press the **Import** button in the bottom left-hand corner of the window and select the desired `.SAM42` file to load in a previous calibration file.

4.3.2 Verification of background noise calibration

Procedure

Return to the home screen to verify the background noise calibration of the device. The Noise Intensity graph on the left-hand side of the window displays two lines:

- a. Raw output noise
- b. Sand noise

With the calibration, the raw output should be above the sand noise line, showing that the calculation has successfully removed the background noise, leaving only particle impact noise.

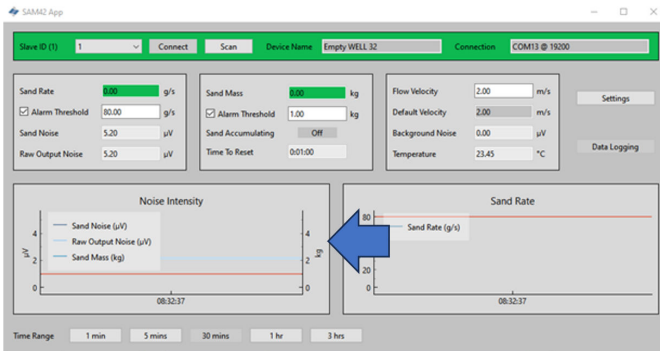

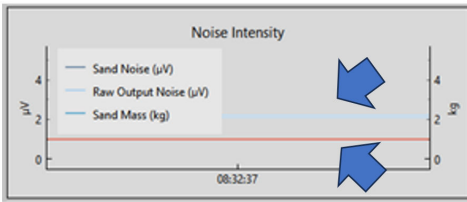

4.4 Sand noise calibration

It is recommended to complete sand noise calibration for the device to ensure that it has the highest accuracy possible. During this, sand is injected in known quantities and velocities. This will generate calibration curves which will allow the device to detect sand and quantify it.

Note

Additional equipment (sand injector) will be required to complete this phase.

Additional information can be given by contacting your local service team representative.

The process details the device level sand calibration.

For this process, a minimum of six data collections are required:

- Three variable flow velocities with a fixed sand rate
 - Flow rates are suggested to be minimum, maximum, and median of expected operational velocities.
- Three fixed flow velocity with variable sand rates

Connection to the device is the same as described in [Connecting to the device and commissioning homescreen](#).

Procedure

1. From the home screen, press the **Settings** button on the right-hand side of the window to navigate to the **Settings** window.

In the **Settings** window, click on the **Sand Noise Calibration** tab.

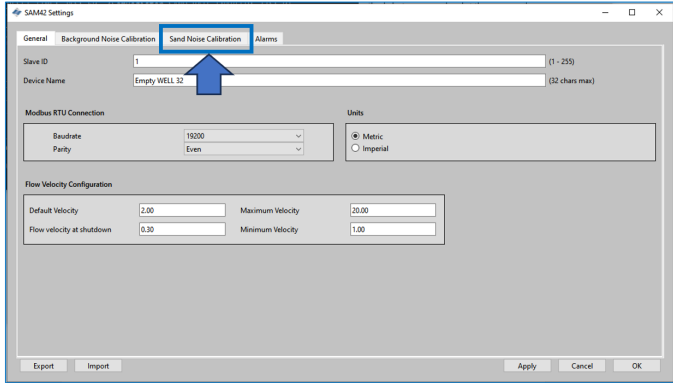

2. The **Sand Noise Calibration** tab will then open with three options:

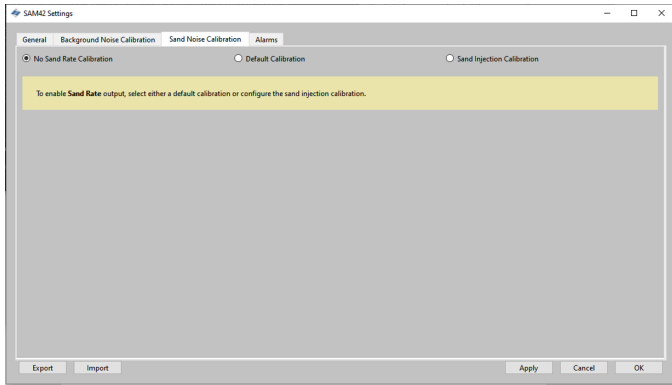

- **No Sand Rate Calibration:** This sets all the coefficients on the device which determine the sand noise calibration to zero. This results in the device only reporting a raw noise output, which would give an indication of solid production intensity. To make this selection, ensure that **No Sand Rate Calibration** is selected. Then, press **Apply** and **OK**.
- **Default Calibration:** This will use generic coefficients for the sand noise calibration. This will be for indication only and the accuracy will depend on application. To make this selection, ensure that **Default Calibration** is selected. Then, press **Apply** and **OK**.
- **Sand Injection Calibration:** This requires additional data to be gathered in a similar way to background noise calibration. This process is detailed in [Step 3](#).

3. When **Sand Injection Calibration** is selected, the following window will appear. Two tables are on the right-hand side which will calculate different coefficients for the calibration.
 - **Top table:** This is used to record the three fixed sand rate with variable flow velocity results.
 - **Bottom table:** This is used to record the three fixed velocity with variable sand rate results.

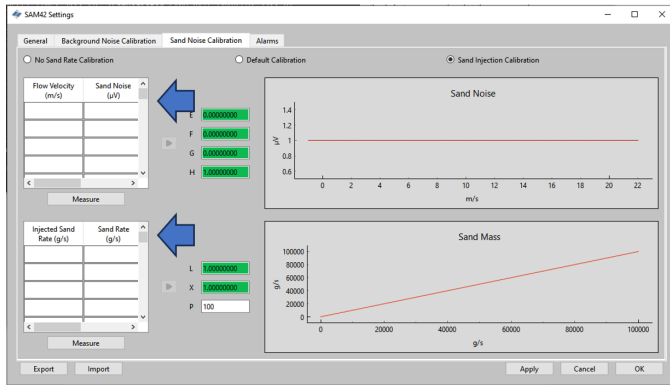

4.4.1 Sand noise calibration: fixed sand rate with varying flow velocity

In this part of the calibration, it is recommended that a minimum of three measurement points are used, following the recommendations stated below:

- **Sand rate**
 - Each of the injections for this test should ensure that the same sand rate is achieved (e.g., 0.5 g/s).
- **Flow velocity**
 - Minimum expected flow rate in operation
 - Maximum expected flow rate in production
 - Median expected flow rate in production
 - Additional points can be taken but these should remain between the minimum and maximum operating limits.

Procedure

1. To open the **Measurement** window, press the **Measure** button. Manually enter the flow velocity at which the test will be conducted.

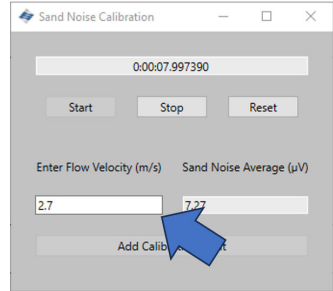
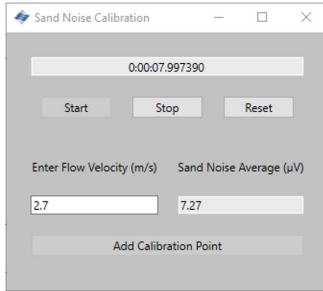

2. Start the recording of the data just before starting the injection of the sand to ensure that the time when sand impacts is captured. To start recording, press the **Start** button.

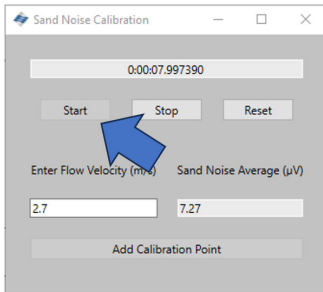

3. Wait until the injection has completed before stopping the recording. It should be noted that once the injection has completed it may take some time for the remaining sand to travel to where the device is mounted (dependent on distance and flow velocity). To stop the recording, press the **Stop** button.

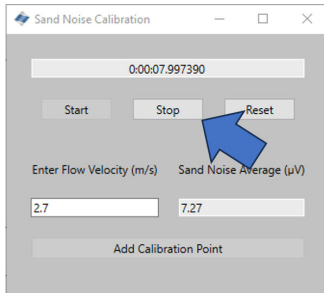

4. Ensure there is a value in the **Sand Noise Average** cell which shows data has been recorded. To record this data in the Sand Noise Calibration table, press the **Add Calibration Point** button.

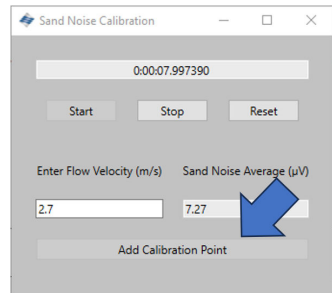
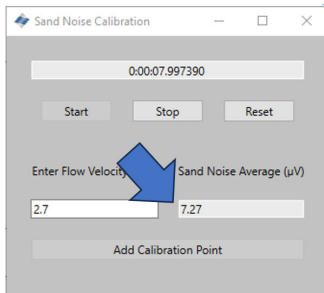

5. Repeat this process for the remaining velocities in the schedule. This is done by pressing the **Reset** button and repeating the steps above until the three data points have been collected.

Close the window and return to the **Sand Noise Calibration** window where data will now be present in the top table.

- 6. Press the **Measure** button under the top table on the left-hand side of the window.

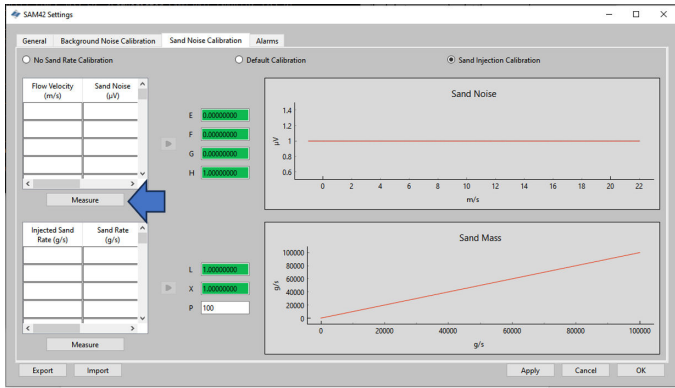

- 7. The measurement window will open. Manually enter the flow velocity at which the test will be conducted.

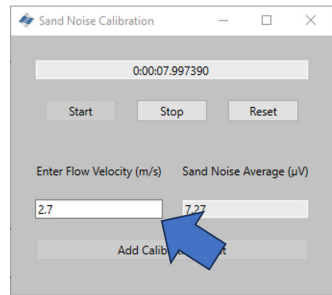
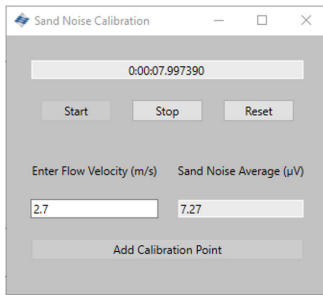

- 8. Start the recording of the data just before starting the injection of the sand to ensure that the time when sand impacts is captured. To start recording, press the **Start** button.

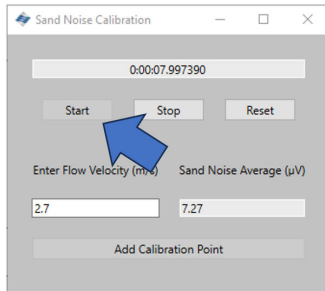

9. Wait until the injection has completed before stopping the recording. It should be noted that once the injection has completed it may take some time for the remaining sand to travel to where the device is mounted (dependent on distance and flow velocity). To stop the recording, press the **Stop** button.

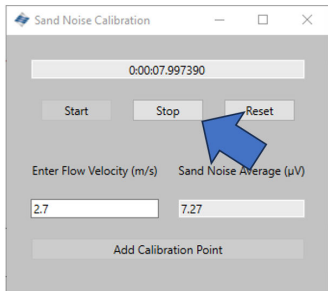

10. Once the recording has been stopped, ensure there is a value in the **Sand Noise Average** cell which shows that data has been recorded. To record this data in the Sand Noise Calibration table, press the **Add Calibration Point** button.

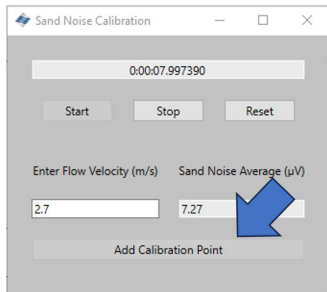
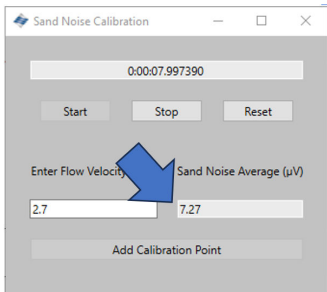

- Repeat this process for the remaining velocities in the schedule. This is done by pressing the **Reset** button and repeating the steps above until the three data points are complete.

Close the window and return to the **Sand Noise Calibration** window where the top table will now have data.

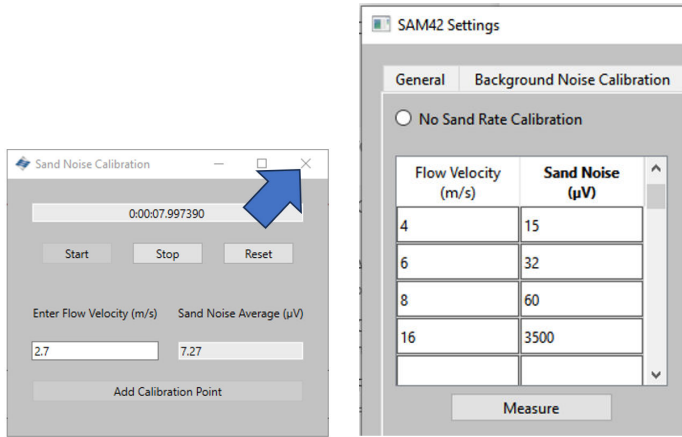

- The next step is to compute the next four coefficients for the device to be calibrated. This is done by pressing the grey arrow (▶) next to the table which will then populate the coefficients.

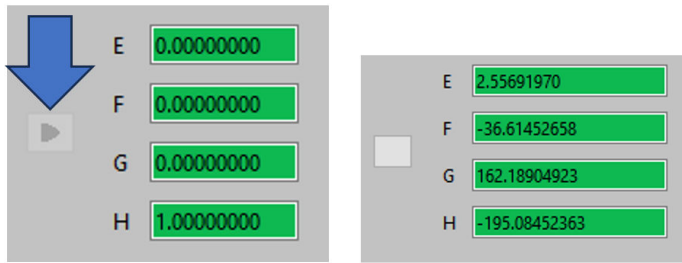

13. Verify the calibration by inspecting the graph on the right hand of the window showing the generated polynomial curve and where the measurement points fit on the curve. Check that the points are on, or close to the line, to ensure a good calibration.

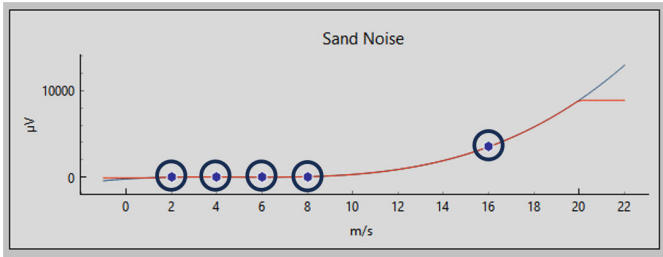

4.4.2 Sand noise calibration: varying sand rate with fixed flow velocity

In this part of the calibration, it is recommended that as a minimum of three measurement points are used following the recommendations stated below:

- **Sand rate**

A minimum of three different sand rates should be chosen which would be representative of expected conditions during operation. An example of what could be used is shown below:

- 0.1 g/s
- 1.0 g/s
- 2.0 g/s

- **Flow velocity**

Flow velocity should remain constant. It is recommended to use the expected velocity which will be used during operation.

Procedure

1. Press the **Measure** button under the table in the bottom left-hand side of the window which will bring up the data capture window.

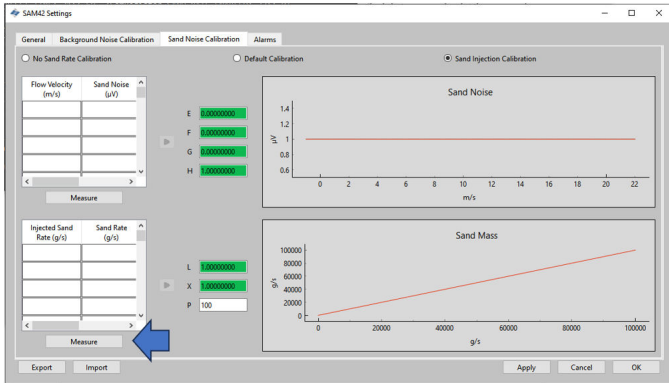

2. In the **Measurement** window which opens, manually enter the flow velocity at which the test will be conducted.

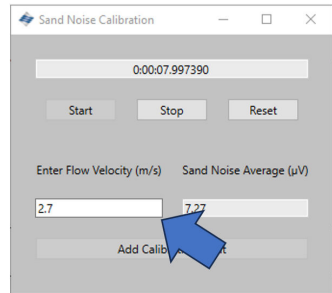
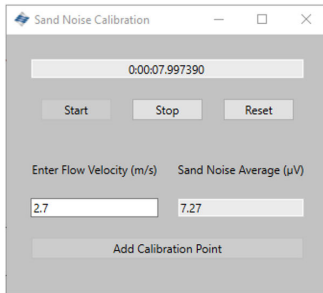

3. Start the data recording just before starting the injection of the sand to ensure that the time sand starts to impact is captured. To start recording, press the **Start** button.

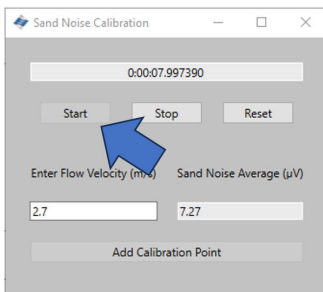

4. Wait until the injection has completed before stopping the recording. It should be noted that once the injection has completed it may take some time for the remaining sand to travel to where the device is mounted (dependent on distance and flow velocity). To stop the recording, press the **Stop** button.

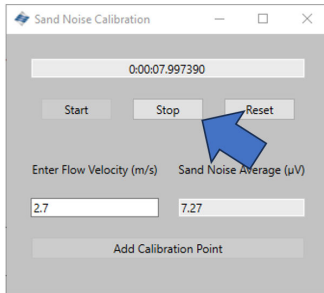

5. Once the recording is stopped, ensure there is a value in the **Sand Noise Average** cell which shows that there has been data recorded. To record this data in the Sand Noise Calibration table, press the **Add Calibration Point** button.

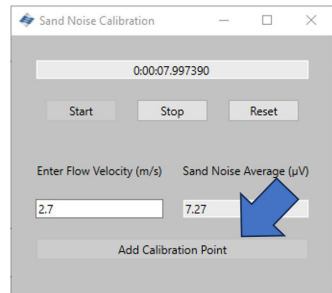
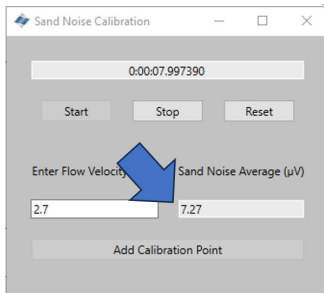

- Repeat this process for the remaining velocities in the schedule. This is done by pressing the **Reset** button and repeating the steps above until the three data points are complete.

Close the window and return to the **Sand Noise Calibration** window where the top table will now have data.

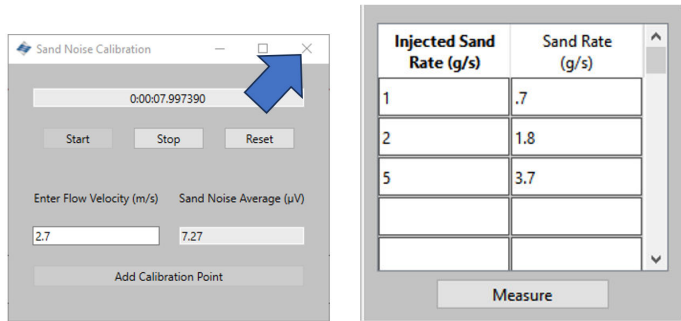

- The next step is to compute the next four coefficients for the device to be calibrated by entering the particle size, which has been used for testing, which should be representative of the particles that will be seen during operation. Press the grey arrow (➤) next to the table which will populate the coefficients.

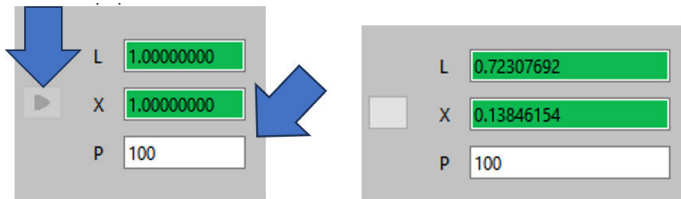

- The scale of the y-axis will have changed from the initial screen, verifying the calibration.

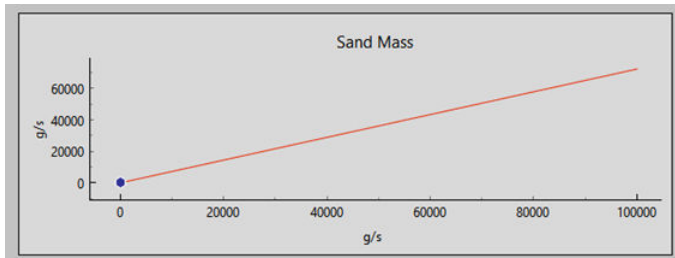

4.4.3 Finalizing sand noise calibration

Procedure

1. Once gathering the data for the sand noise calibration is completed, press the **Apply** button in the bottom right-hand corner of the window in order for the coefficients generated to be written to the device.
2. Once the coefficients have been written to the device, exit the calibration window. Then, press **OK** to return to the home screen.

At this stage, the background noise calibration for the device has been completed. There are some additional features on the background noise calibration window which can be used:

- **Export**

Once calibration has been completed, the calibration data and coefficients from the application may be exported. This will be in the form of a `.SAM42` file. Press the **Export** button in the bottom left-hand corner of the window to store this file for future use.

- **Import**

Press the **Import** button in the bottom left-hand corner of the window and select the desired `.SAM42` file to load in a previous calibration file.

5 Setting alarms

5.1 Alarm configuration

The primary purpose of the SAM42 system is to warn the user whenever the sand production rate exceeds an acceptable level. This section describes the process which is used to set the alarms for the Rosemount SAM42 Acoustic Particle Monitor.

Procedure

1. With the device connected to a PC/Tablet running the Commissioning application. From the home screen, press the **Settings** button to navigate to the **Settings** window.

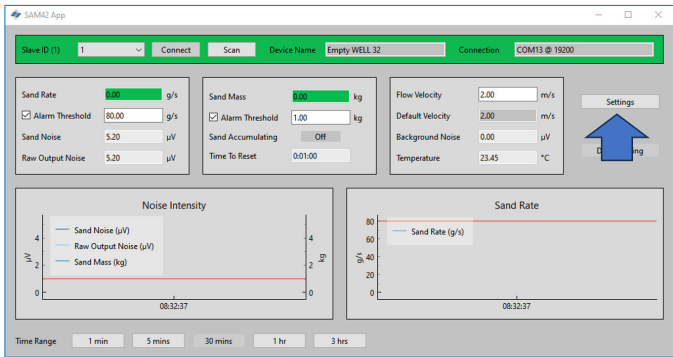

2. Press **Alarms** to navigate to the **Alarms** tab.

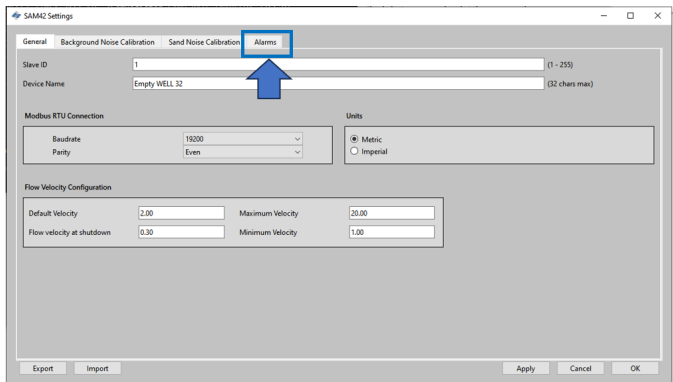

3. From the **Alarms** tab window, alarms can be configured.

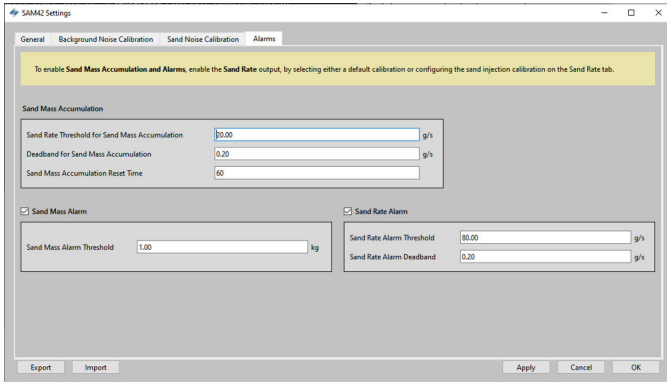

5.1.1 Sand mass accumulation

The sand rates at which the accumulation will start being counted may be set from this window.

Sand rate threshold for sand mass accumulation

This is the sand rate at which the system will start measuring accumulated sand. Ideally, this would be matched to sand rate alarm threshold.

Default value: 1.000 g/s

Deadband for sand mass accumulation

This is how much the sand rate has to drop before the accumulation will be halted.

Example: With a threshold set to 20 g/s and when this drops to 19.8 g/s, the accumulation calculation will be halted.

Sand mass accumulation reset time

Enter the maximum allowable time between two alarm output states (i.e. when accumulator is on) before the accumulator is reset and already triggered alarm is reset.

5.1.2 Sand alarm mass threshold

Once the sand production rate exceeds the set **Sand Alarm Level**, an accumulator starts to accumulate the sand production until the rate falls below the **Sand Alarm Level** minus **Alarm Bound Limit**.

If the rate drops below this for a time period longer than the **Time to alarm reset**, the accumulator is reset to zero.

However, if the rate rises again above the **Sand Alarm Level** within the **Time to alarm reset** period, the accumulator continues to accumulate the sand production. When the accumulated sand production exceeds the **Sand Alarm Mass**, a **Sand Alarm** is generated. (See [Figure 5-1](#)). This alarm will be reset when the rate drops below the **Sand Alarm Level** minus **Alarm Bound Limit** for a time period longer than the **Time to alarm reset**. This will be directly affected by the values which are entered in **Sand Mass Accumulation**.

Figure 5-1: Example of Sand Accumulation and Alarm Graph

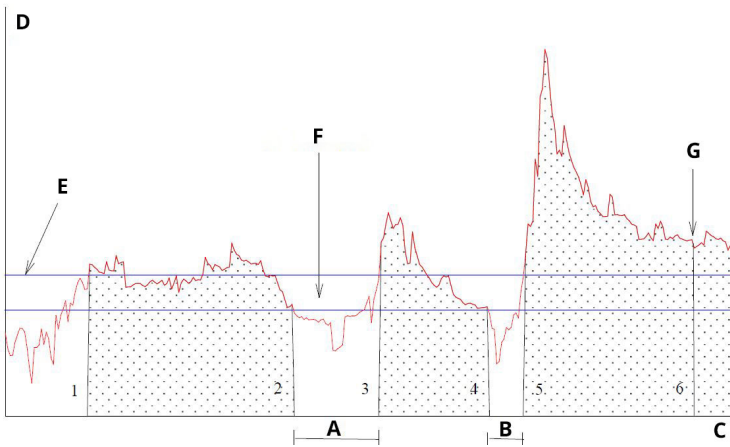

- A. *T1*
- B. *T2*
- C. *Time*
- D. *Sand [g/s]*
- E. *Sand alarm level*
- F. *Alarm bound limit for selected well*
- G. *Mass alarm (sand alarm is triggered)*

5.1.3 Sand rate alarm

It is recommended that this is either set to the same value as sand rate threshold for sand mass accumulation, or a lower rate. When the sand rate exceeds the value, an alarm is triggered.

Default value: 1.000 g/s

5.1.4 Sand rate alarm deadband

When the sand rate drops below the **Sand Alarm Level** minus the **Alarm Bound Limit**, sand mass accumulation is halted. Enter an appropriate Limit.

Default value: 0.100 g/s

5.1.5 Applying alarms

Press **Apply** in the bottom right-hand corner of the window. Then, press **OK** to exit to the home screen.

Alarm values are also visible on the commissioning application home screen.

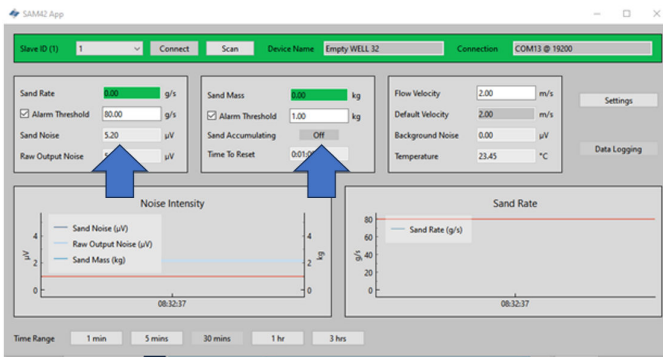

6 Rosemount SAM42 Acoustic Particle Monitor in operation

This section covers how the device interacts with the control systems, whether directly wired into the control system or using analytical software.

Figure 6-1: Suggested wiring diagram into DCS safe area

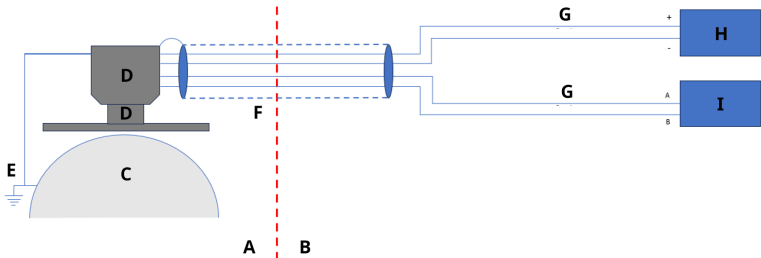

- A. Hazardous area
- B. Safe area
- C. Pipe
- D. Rosemount SAM42
- E. PE
- F. 4-Wire field cable
- G. 2-Wire
- H. PSU (24 Vdc)
- I. Distributed Control System (DCS)

6.1 SAM42 Digital interface

The Rosemount SAM42 can be interfaced directly to the Process/Distributed Control System (PCS/DCS), or to a permanent server running Fieldwatch software, or to a service computer running the SAM42 Acoustic Particle Commissioning application. See diagrams below reflecting all interface options.

6.1.1 Interface to a service laptop running SAM42 Commissioning app

To configure and calibrate the SAM42 device, a service PC running the SAM42 commissioning app is required. The service PC should be connected to the SAM42 device via the SAM42 commissioning cable. The commissioning cable contains both the RS485-USB converter and a battery power supply for the SAM42.

Figure 6-2: Ex-d interfacing between SAM42 and Commissioning Application

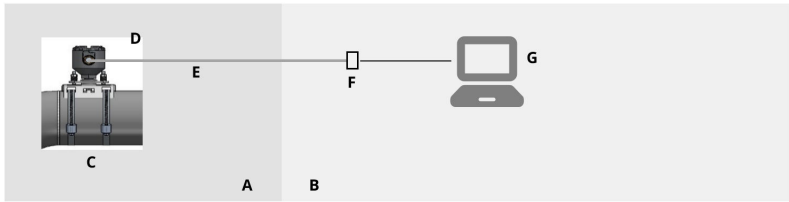

- A. Hazardous area
- B. Safe area
- C. Acoustic Particle Monitor
- D. Modbus RTU RS485
- E. Ex d cable
- F. Power and RS485 to USB converter
- G. SAM42 Commissioning App

Figure 6-3: Ex-ia interfacing between SAM42 and Commissioning Application

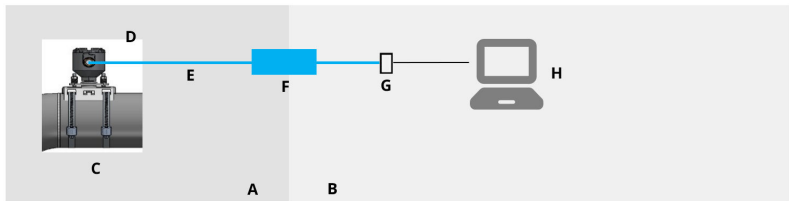

- A. Hazardous area
- B. Safe area
- C. Acoustic Particle Monitor
- D. Modbus RTU RS485
- E. Ex i cable
- F. Safety barrier
- G. Power and RS485 to USB converter
- H. SAM42 Commissioning App

6.1.2 Distributed Control System (DCS)/ Process Control System (PCS) interface

Each Rosemount SAM42 is a Modbus slave unit with a unique Modbus slave ID. To maintain a polling rate of one reading per second, ensure that the conditions below are taken into

consideration when connecting multiple SAM42s are chained together.

In Ex-d applications, it is possible to connect up to 32 devices on a two wire RS485 process bus. There may be a requirement to change the baud rate of the devices to ensure that the polling rate of one reading per second is maintained.

Ex-a applications are limited to three devices. This is due to the current limitations on the barriers which are used. If connecting more than three devices through the same barrier, then the polling rate will drop below one reading per second.

The communication protocol is standard Modbus RTU mode. The SAM42 device stores all the configuration data and calibration coefficients in a flash memory and needs no computer for normal operation hooked up to the PCS/DCS.

The PCS/DCS supplies the SAM42 device with flow velocity parameters and retrieves computed sand rate values as well as sand alarms and technical error alarms from the SAM42. Digital interface is represented in [Figure 6-4](#) and [Figure 6-5](#). In cases where the flow velocity is not available from the PCS/DCS, a static flow velocity can be set.⁽¹⁾

Figure 6-4: Ex-d interfacing between SAM42 and DCS

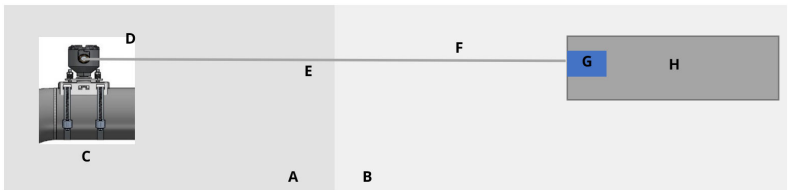

- A. Hazardous area
- B. Safe area
- C. Acoustic Particle Monitor
- D. Modbus RTU RS485
- E. Ex d cable
- F. Modbus RTU RS485 and Power
- G. 24 Vdc
- H. Distributed Control System (DCS)

⁽¹⁾ If a static velocity is set, this will have impact on device accuracy. For optimal accuracy results, it is recommended that a live flow rate is supplied from the DCS/PCS to the device.

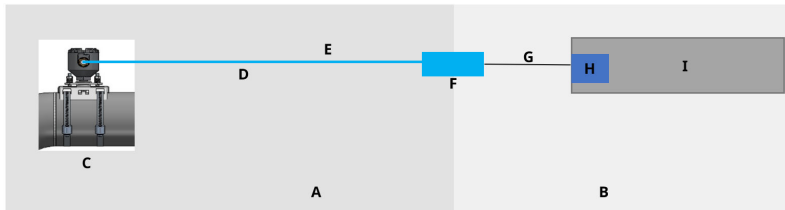
Figure 6-5: Ex-ia interfacing between SAM42 and DCS

- A. Hazardous area
- B. Safe area
- C. Acoustic Particle Monitor
- D. Ex i cable
- E. Modbus RTU RS485 and Power
- F. Safety barrier
- G. Serial cable
- H. 24 Vdc
- I. Distributed Control System (DCS)

6.1.3 Interface to a fieldwatch server

The Rosemount SAM42 device can also be connected to a permanent server with Fieldwatch software. The server handles all communication with the SAM42 device. With a permanent server connected to the SAM42 device, the server can act as one single Modbus slave against DCS/PCS. With this software option, the PCS/DCS can address all SAM42 devices connected to the system via two Modbus calls, one for writing the flow velocity, and one for reading sand rates and alarm status. The hard drive on the server can also be used for trend data storage. Digital interface is represented in the [Figure 6-6](#) and [Figure 6-7](#).

Figure 6-6: Ex-d interfacing between SAM42 and Fieldwatch

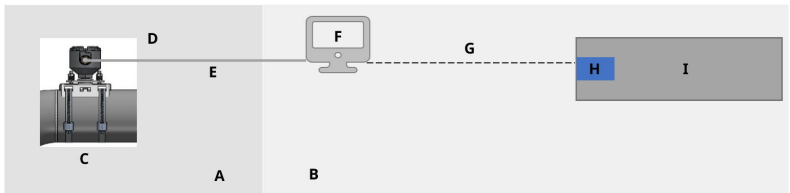

- A. Hazardous area
- B. Safe area
- C. Acoustic Particle Monitor
- D. Modbus RTU RS485
- E. Ex d cable
- F. Fieldwatch
- G. RS485/RS232/TCP
- H. 24 Vdc
- I. Distributed Control System (DCS)

Figure 6-7: Ex-ia interfacing between SAM42 and Fieldwatch

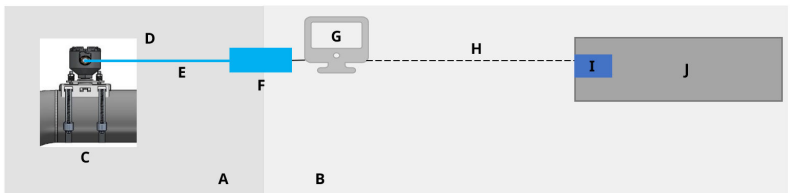

- A. Hazardous area
- B. Safe area
- C. Acoustic Particle Monitor
- D. Modbus RTU RS485
- E. Ex i cable
- F. Safety barrier
- G. Fieldwatch
- H. RS485/RS232/TCP
- I. 24 Vdc
- J. Distributed Control System (DCS)

The SAM42 device set-up in Fieldwatch is performed by Emerson service personnel.

Note

Fieldwatch is a software that Emerson is no longer developing (not adding new features/ enhancements) but SAM42 device is compatible with Fieldwatch to support upgrades of the existing installed base running Fieldwatch.

7 Reference information

This equipment is suitable for outdoor use under the following environmental conditions:

- Maximum altitude: 2,000 m
- Ambient temperature: -40 °F (-40 °C) to 176 °F (80 °C)
- 0 to 100% relative humidity
- Ingress protection - Enclosure Type 4X, IP66

Electrical characteristics: 24 Vdc nominal input voltage (9 V – 28 V rated voltage range), I_{max} 20 mA

7.1 Modbus map

The table states the values from the device and which register that they can be found in.

Variable name	Register	Type
Process data		
Sand Rate	0	float
Sand Noise	2	float
Raw Output Noise	4	float
Sand Mass	6	float
Board Temperature	8	float
Velocity input		
Flow Velocity (Input)	10	float
Alarm indicators (LED)		
Sand Rate Alarm	12	Boolean
Sand Mass Accumulating	13	Boolean
Sand Mass Time Remaining to Reset	14	uint32
Sand Mass Alarm	16	Boolean
Diagnostics		
System Status	18	uint16
Reset Counter	19	uint16
Uptime (seconds)	20	uint32

This section contains details and further information which needs to be taken into consideration when installing a Rosemount SAM42 Acoustic Particle Monitor.

7.2 Engineering units

The Rosemount SAM 42 Acoustic Particle Monitor supports only engineering units according to the International System of Units (SI). The following engineering units are used during configuration and commissioning:

Variable	Symbol	Unit
Sand intensity	μV	Microvolts
Sand rate	g/s	Grams per second
Sand quantification	g	Grams
Flow velocity	m/s	Meters per second
Temperature	$^{\circ}\text{C}$	Degrees Celsius
Power supply	Vdc	DC voltage

7.3 Process data

Calculating the sand rate requires information/ input about the flow velocity.

Velocity input

The velocity must be measured/computed externally and then supplied directly in m/s. This is mapped directly from the DCS/PCS according to the table in [Modbus map](#).

The more accurate the velocity input is, the more accurate sand rate calculation is achieved by the SAM42 device.

Velocity input can be fed continuously from DCS to capture fluctuating velocity.

7.4 Device functional testing

Having ensured that wiring is correct and safe, power may be switched on and functional testing of the installation can be carried out.

Power up the system. Indication of communication with the detector on the pipe should be visible in the SAM42 Commissioning app.

Using a PC running the Rosemount SAM42 Commissioning app attached to the RS485 port, a sensitivity test should be carried out

as a final function test of the detector. Press and twist a sandpaper (Grade 60 – 100) against the pipe a few inches (5 to 10 cm) aside of the detector, using your thumb.

- Perform a sandpaper test while monitoring the raw signal trend window in the main menu of the SAM42 Commissioning app. A signal peak above 50 μv should appear as a response to the sandpaper test.
- If response is missing or less than 50 μv despite repeated sandpaper tests, the sensor contact with the pipe should be checked and refreshed with new silicone grease. Once an appropriate raw signal response has been obtained, the detector installation has been checked OK and is ready for calibration. Calibration should only be carried out by Emerson personnel or personnel trained by Emerson.

8 Maintenance of Rosemount SAM42 Acoustic Particle Monitor

Optimal performance of the SAM42 requires a regular schedule of simple maintenance checks, followed up, if necessary, by prompt service.

The equipment does not contain any parts larger than 1000 mm or more than 50 kg that need to be moved during maintenance. Check the dimensional drawing in [Figure 8-1](#).

Service to the SAM42 is limited to replacing the mounting kit or individual elements of the mounting solution (nuts, strap, mounting socket, etc). See [Rosemount SAM42 Acoustic Particle Monitor Product Data Sheet](#) list for details.

In case of a SAM42 detector replacement, it is recommended to call for Emerson service engineer or personnel trained and authorized by Emerson, for the configuration of the device.

Figure 8-1: Installation Control Drawing

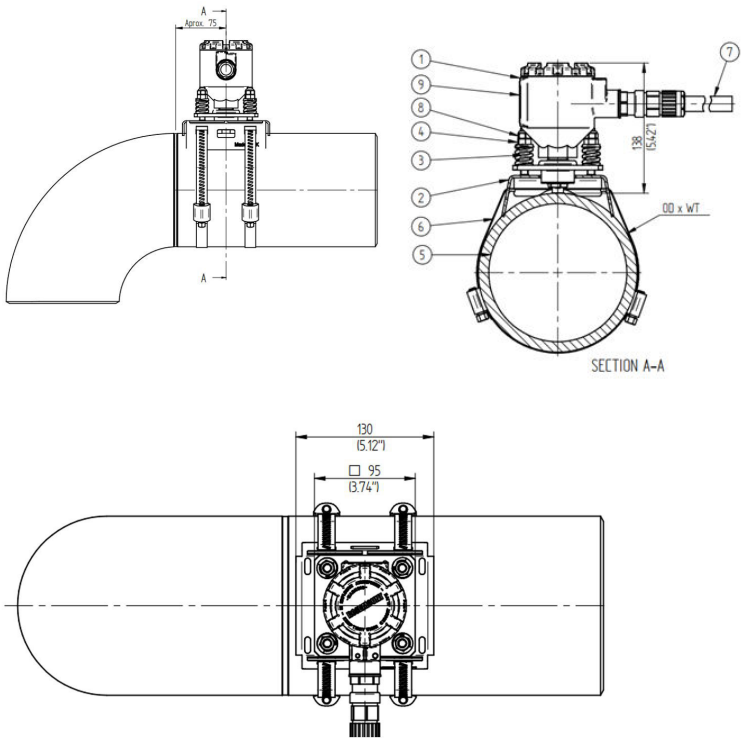

1. Rosemount SAM42 Transmitter
2. Mounting socket
3. Loading springs
4. Compression nut
5. Pipeline
6. Mounting strap
7. Field cable
8. Locking nut
9. Product label

Dimensions are in millimeters (inches).

8.1 Preventive maintenance

8.1.1 Visual inspection

Time period	Monthly
Required tooling	None
Estimated duration	0.2 hours/ per detector
Downtime	0%

8.1.2 Routine testing

Time period	Monthly
Required tooling	Sandpaper
Estimated duration	0.1 hour/ per detector
Downtime	0.014%

8.1.3 Instructions for cleaning and maintenance

Remove salt buildup, rust, and other contamination found during visual inspection or routine testing.

8.2 Corrective maintenance

Personnel trained by Emerson can carry out minor adjustments of the calibration curves. If such adjustments are carried out regularly, they will improve the performance of the system.

8.2.1 Background noise calibration

Time period	Annually
Required tooling	Tablet PC (inc. Commissioning App)
Estimated duration	3 hours/ per detector
Downtime	0.034%

8.2.2 Sand calibration

Time period	Annually
Required tooling	Tablet PC (inc. Commissioning App) Sand Injection Skid
Estimated duration	12 hours/ per detector
Downtime	0.137%

8.2.3 Reinstalling or replacing the SAM42 detector

To remove the detector unit from the pipe, unscrew the four mounting nuts of the bolts using a 13 mm spanner, being careful to avoid nuts and springs falling off, then pull up the detector from the mounting socket, sliding through the bolts.

Replacing a SAM42 detector will require a new calibration. Before installing the new detector, ensure it can be done safely. The detector's weight is ~3kg and it can cause damage if accidentally dropped. Use scaffolding if required.

To physically install the new detector, follow the steps detailed in [Physical installation of the device](#).

9 Product certifications

Installation of this device in an explosive environment must be in accordance with the appropriate local, national, and international standards, codes, and practices. Review this section of the manual for any restrictions associated with safe installation.

Before connecting a SAM42 in an explosive atmosphere, make sure the instruments in the segment are installed in accordance with intrinsically safe or non-incendive field wiring practices. Verify that the operating atmosphere at the installation location of the device is consistent with the device's hazardous location certification.

Note

The Standard Temperature variant markings are denoted by (ST) and the High Temperature variant markings are denoted by (HT).

9.1 European Directive information

A copy of the EU Declaration of Conformity can be found at the end of the Quick Start Guide. The most recent revision of the EU Declaration of Conformity can be found at [Emerson.com/Rosemount](https://www.emerson.com/Rosemount).

9.2 Ordinary location certification

As standard, the device has been examined and tested to determine that the design meets the basic electrical, mechanical, and fire protection requirements by a Nationally Recognized Test Laboratory (NRTL) as accredited by the Federal Occupational Safety and Health Administration (OSHA).

9.3 North America

The US National Electrical Code® (NEC) and the Canadian Electrical Code (CEC) permit the use of Division marked equipment in Zones and Zone marked equipment in Divisions. The markings must be suitable for the area classification, gas, and temperature class. This information is clearly defined in the respective codes.

9.4 Electromagnetic compatibility (EMC)

The Rosemount SAM42 Acoustic Particle Monitor meets all industrial environment requirements of the 2014/30/EU (EMC Directive); FCC/CFR 47:Part 15B 15.109 and 15.107, Class A; ICES 003:Issue 7; ANSI C63.4:2014.

9.5 USA

9.5.1 USA Explosion-proof

Certificate: SGSNA/24/SUW/00028X

Standard: UL 1203, 6th Ed., Rev 2023

Marking: XP CL I, DIV 1, GP CD, T4 (ST) and XP CL I, DIV 1, GP CD, T2 (HT) ($-40\text{ °C} \leq T_a \leq +75\text{ °C}$)

Specific conditions of use:

1. Product must be installed per NEC 70 Section 501 for hazardous locations.
2. Product not intended for connection with rigid metallic conduits as it was not tested for that configuration.

9.6 Canada

9.6.1 Canada Explosion-proof

Certificate: SGSNA/24/SUW/00028X

Standard: CSA C22.2 No. 30:20, 4th Ed., April 2020 Rev: March 2023

Marking: XP CL I, DIV 1, GP CD, T4 (ST) and XP CL I, DIV 1, GP CD, T2 (HT) ($-40\text{ °C} \leq T_a \leq +75\text{ °C}$)

Specific conditions of use:

1. Product must be installed per NEC 70 Section 501 for hazardous locations.
2. Product not intended for connection with rigid metallic conduits as it was not tested for that configuration.

9.7 Europe

9.7.1 ATEX Flameproof

Certificate: SGS23ATEX0042X

Standard: EN IEC 60079-0: 2018 and EN 60079-1: 2014

Marking: II 2 G, Ex db IIB T6...T4 Gb (ST) and II 2 G, Ex db IIB T6...T2 Gb (HT) ($-40\text{ °C} \leq T_a \leq +75\text{ °C}$)

Specific conditions of use:

1. Cable glands enabling cables to enter the enclosure shall be ATEX certified as equipment. When installed, the cable gland must maintain the marked IP rating of the enclosure.
2. End users must follow specific installation and operating instructions supplied by the manufacturer to prevent exceeding the heat dissipating limits for the desired temperature code for an operating ambient and to follow the information regarding the correct selection of cables and cable glands.
3. The painted enclosure may present a potential electrostatic ignition hazard and must not be rubbed or cleaned with a dry cloth.
4. The maximum input power is restricted to 0.5 W.

9.7.2 ATEX Intrinsic safety

Note

This certification is not yet available. It has been applied for and is currently in process.

Certificate: Not yet available

Standard: EN IEC 60079-0: 2018 and EN 60079-11: 2023

Marking: II 1 G, Ex ia IIB T4 Ga (ST) and II 1 G, Ex ia IIB T2 Ga (HT)
($-40\text{ °C} \leq T_a \leq +75\text{ °C}$)

Specific conditions of use:

TBA

9.8 International

9.8.1 IECEx Flameproof

Certificate: IECEx SGS 23.0041X

Standard: IEC 60079-0: 2017 Ed 7.0 and IEC 60079-1: 2014 Ed 7.0

Marking: Ex db IIB T6...T4 Gb (ST) and Ex db IIB T6...T2 Gb (HT)
($-40\text{ °C} \leq T_a \leq +75\text{ °C}$)

Specific conditions of use:

1. Cable glands enabling cables to enter the enclosure shall be IECEx certified as equipment. When installed, the cable gland must maintain the marked IP rating of the enclosure.

2. End users must follow specific installation and operating instructions supplied by the manufacturer to prevent exceeding the heat dissipating limits for the desired temperature code for an operating ambient and to follow the information regarding the correct selection of cables and cable glands.
3. The painted enclosure may present a potential electrostatic ignition hazard and must not be rubbed or cleaned with a dry cloth.
4. The maximum input power is restricted to 0.5 W.

9.8.2 IECEx Intrinsic safety

Note

This certification is not yet available. It has been applied for and is currently in process.

Certificate: Not yet available

Standard: IEC 60079-0: 2017 Ed 7.0 and IEC 60079-11: 2023 Ed 7.0

Marking: Ex ia IIB T4 Ga (ST) and Ex ia IIB T2 Ga (HT) ($-40\text{ °C} \leq T_a \leq +75\text{ °C}$)

Specific conditions of use:



TBA

Manufacturing location address

Permasense Ltd, Emerson, Alexandra House, Newton Road, Manor Royal, Crawley, RH10 9TT, UK

Phone: +44 20 3002 3672

10 Declaration of Conformity

 EMERSON EU Declaration of Conformity 			
<p>We, the manufacturer,</p> <p>Permasense Ltd Alexandra House, Newton Road, Manor Royal, Crawley RH10 9TT, UK</p> <p>declare under our sole responsibility that the products,</p> <p>Rosemount™ SAM42 Acoustic Particle Monitor Rosemount™ PDS42 Acoustic PIG Detector</p> <p>to which this declaration relates, is in conformity with the relevant European Union harmonisation legislation.</p>			
EMC Directive (2014/30/EU)	Harmonised standard: EN IEC 61326-1:2021		
ATEX Directive (2014/34/EU)	SGS23ATEX0042X – Flameproof EU type examination certificate <table style="width: 100%;"> <tr> <td style="width: 50%;"> Standard Temperature (ST) Ⓔ II 2G, Ex db IIB T6...T4 Gb (-40°C ≤Tas +75°C) </td> <td style="width: 50%;"> High Temperature (HT) Ⓔ II 2G, Ex db IIB T6...T2 Gb (-40°C ≤Tas +75°C) </td> </tr> </table> <p style="text-align: center;">Harmonised standards: EN IEC 60079-0: 2018 EN 60079-1: 2014</p>	Standard Temperature (ST) Ⓔ II 2G, Ex db IIB T6...T4 Gb (-40°C ≤Tas +75°C)	High Temperature (HT) Ⓔ II 2G, Ex db IIB T6...T2 Gb (-40°C ≤Tas +75°C)
Standard Temperature (ST) Ⓔ II 2G, Ex db IIB T6...T4 Gb (-40°C ≤Tas +75°C)	High Temperature (HT) Ⓔ II 2G, Ex db IIB T6...T2 Gb (-40°C ≤Tas +75°C)		
ATEX Notified Body for EU Type Examination Certificate: SGS Fimko Oy (Notified body number 0598) Takomotie 8 FI-00380 Helsinki Finland	ATEX Notified Body for Quality Assurance SGS Fimko Oy (Notified body number 0598) Takomotie 8 FI-00380 Helsinki Finland		
Authorised Representative in Europe and Northern Ireland: Emerson S.R.L. , company No. J12/88/2006, Emerson 4 street, Parcul Industrial Tatarom II, Cluj-Napoca 400638, Romania Regulatory Compliance Shared Services Department Email: europaeproductcompliance@emerson.com Phone: +40 374 132 000			
Signed for and on behalf of Permasense Ltd.			
 _____ (Signature)	26 th March 2024 (date of issue)		
Philip Pakianathan (Name)	Global Engineering and Operations Director (Function)		
Crawley, UK (Place of issue)			



Quick Start Guide
MS-00825-0100-3636, Rev. AA
May 2024

For more information: [Emerson.com/global](https://www.emerson.com/global)

©2024 Emerson. All rights reserved.

Emerson Terms and Conditions of Sale are available upon request. The Emerson logo is a trademark and service mark of Emerson Electric Co. Rosemount is a mark of one of the Emerson family of companies. All other marks are the property of their respective owners.

ROSEMOUNT™

