

Emerson Wireless 1410S Gateway and 781S Smart Antenna



NOTICE

Read this manual before working with the product. For personal and system safety, and for optimum product performance, ensure you thoroughly understand the contents before installing, using, or maintaining this product.

Within the United States, Emerson has two toll-free assistance numbers:

Global Service Center

Software and Integration Support

1-800-833-8314 (United States)

+63-2-702-1111 (International)

Customer Central

Technical support, quoting, and order-related questions.

1-800-999-9307 (7:00 am to 7:00 pm CST)

North American Response Center

Equipment service needs.

1-800-654-7768 (24 hours—includes Canada)

Outside of the United States, contact your local Emerson representative.

⚠ WARNING

Failure to follow these installation guidelines could result in death or serious injury.

Ensure only qualified personnel perform the installation.

Explosions could result in death or serious injury.

Verify that the operating environment of the device is consistent with the appropriate hazardous locations certifications.

Do not make or break connections while circuits are live unless the area is known to be non-hazardous.

Potential electrostatic charging hazard. The enclosure is engineered polymer. Use care in handling and cleaning when in explosive environments to avoid an electrostatic discharge.

Electrostatic discharge can damage electronics.

Use proper personal grounding before handling electronics or making contact with leads and terminals.

Electrical shock could cause death or serious injury.

If the device is installed in a high-voltage environment and a fault condition or installation error occurs, high voltage may be present on transmitter leads and terminals.

Use extreme caution when making contact with the leads and terminals.

This device complies with Part 15 of the Federal Communication Commission (FCC) Rules. Operation is subject to the following conditions:

This device may not cause harmful interference. This device must accept any interference received, including interference that may cause undesired operation.

This device must be installed to ensure a minimum antenna separation distance of 8 in. (20 cm) from all persons.

The products described in this document are NOT designed for nuclear-qualified applications. Using non-nuclear qualified products in applications that require nuclear-qualified hardware or products may cause inaccurate readings. For information on Emerson nuclear-qualified products, contact your local Emerson Sales Representative.

Contents

Chapter 1	Introduction.....	5
	1.1 Emerson Wireless 1410S Gateway 781S Smart Antenna.....	5
	1.2 Using this manual.....	5
	1.3 Product recycling/disposal.....	5
Chapter 2	Configuration.....	7
	2.1 Wireless planning.....	7
	2.2 PC requirements.....	7
	2.3 Initial connection and configuration.....	7
Chapter 3	Installing the Gateway.....	21
	3.1 Emerson Gateway 1410S2 installation overview.....	21
	3.2 Power specifications.....	21
	3.3 Mounting the Emerson 1410S2 Gateway.....	22
	3.4 Mounting the Emerson 781S Smart Antenna.....	24
	3.5 Connecting the Emerson 1410S to the 781S Smart Antennas.....	26
	3.6 Verify operations.....	31
Chapter 4	Commissioning.....	33
	4.1 Overview.....	33
	4.2 System requirements.....	33
	4.3 Software installation.....	34
	4.4 Security setup utility.....	34
	4.5 AMS Wireless Configurator.....	35
	4.6 Licensing and credits.....	36
Chapter 5	Operation and maintenance.....	37
	5.1 Overview.....	37
	5.2 Network architecture.....	37
	5.3 Modbus®.....	38
	5.4 System diagnostic registers with Dual <i>WirelessHART</i> ® enabled for Modbus®, Ethernet/IP™, and OPC®-UA.....	41
Chapter 6	Troubleshooting.....	45
	6.1 Service support.....	45
	6.2 Initial connection: Web browser returns "page not found".....	45
	6.3 Initial connection: Cannot find Gateway after changing IP address.....	46
	6.4 Initial connection: Cannot find Gateway using secondary Ethernet port.....	46
	6.5 Initial connection: Cannot log into the Gateway.....	46
	6.6 AMS Wireless Configurator: Gateway does not appear in AMS Wireless Configurator...	46
	6.7 AMS Wireless Configurator: Wireless devices do not appear under the Gateway.....	47
	6.8 AMS Wireless Configurator: Wireless device appears with red HART® symbol.....	47
	6.9 AMS Wireless Configurator: Device configuration items are grayed out.....	47
	6.10 Wireless field devices: Wireless device does not appear on the network.....	48
	6.11 Wireless field devices: Wireless device appears in the join failure list.....	48

6.12	Wireless field devices: Wireless device appears with service denied.....	48
6.13	Modbus communications: Cannot communicate using Modbus® RTU.....	48
6.14	Modbus communications: Cannot communicate using Modbus® TCP.....	49
6.15	Modbus communications: Cannot communicate using secure Modbus® TCP.....	49
6.16	OPC communications: OPC application cannot find a Gateway OPC server.....	50
6.17	OPC communications: Gateway OPC server does not show any Gateways.....	50
6.18	OPC communications: Gateway OPC server does not show any data tags.....	50
6.19	EtherNet/IP™ : Gateway is not publishing the parameters.....	51
6.20	Return of materials.....	51
Appendix A	Reference data.....	53
A.1	Ordering information, specifications, and drawings.....	53
A.2	Product certifications.....	53
Appendix B	Redundant Gateway systems.....	55
B.1	Overview.....	55
B.2	Requirements.....	55
B.3	Setup.....	55
B.4	Diagnostics	59
B.5	Gateway replacement.....	61
Appendix C	Dual mode (WirelessHART® and IEC 62734) network specifications.....	63
C.1	Dual mode upgrades.....	63
C.2	IEC 62734 Network.....	63
C.3	IEC 62734 Device support.....	64
Appendix D	DeltaV™ ready.....	67
D.1	Overview.....	67
D.2	Latency considerations in control logic design and operation.....	67
D.3	Requirements.....	67
D.4	Mounting the Gateway.....	67
D.5	Setup.....	68
Appendix E	Dual WirelessHART® Feature Guide.....	71
E.1	Hardware compatibility for Dual <i>WirelessHART</i> ®	71
E.2	Upgrading a 1410S Gateway with Dual <i>WirelessHART</i> ®	71
E.3	Dual <i>WirelessHART</i> ® Operation Guide.....	74

1 Introduction

1.1 Emerson Wireless 1410S Gateway 781S Smart Antenna

The Emerson Wireless 1410S Gateway and 781S Smart Antenna combine to create the main access point of a wireless network. Modbus® communications over RS-485 or Ethernet provide universal integration and system interoperability. The optional OPC or EtherNet/IP™ functionality from the Gateway offers a means to connect to newer systems and applications while providing a richer set of data.

1.2 Using this manual

This manual will help you to install, configure, operate, and maintain the Gateway.

- **Configuration:** Configuration describes how to initially connect to the Gateway and the settings to configure before placing it on a live control network.
- **Installing the Gateway:** Installation describes how to properly mount the Gateway and make electrical connections including electrical wiring, grounding, and host system connections.
- **Commissioning:** Commissioning describes installation and setup of the optional software included with the Wireless Gateway. This software aids in secure host integration and wireless field device configuration.
- **Operation and maintenance:** Operation and Maintenance describes how to connect the Gateway to a host system and integrate data gathered from the field device network. It covers network architectures, security, and data mapping.
- **Troubleshooting:** Troubleshooting provides troubleshooting tips and contact information for technical support.
- Appendices provide additional and more specific information on a variety of subjects including Product Certifications.

1.3 Product recycling/disposal

Recycling of equipment and packaging should be taken into consideration and disposed of in accordance with local and national legislation/regulations.

2 Configuration

2.1 Wireless planning

Power up sequences

The Gateway should be installed and functioning properly before power modules are installed in any wireless field devices. Wireless field devices should also be powered up in order of proximity from the Gateway beginning with the closest. This will result in a simpler and faster network installation.

Antenna positions

The Emerson 781S Smart Antenna should be positioned vertically and be approximately 6 ft. (2 m) from large structures or buildings to allow for clear communication to other devices. If using two antennas, each should be mounted at least 3 ft. (0.91 m) from one another.

2.2 PC requirements

Operating system (optional software only)

For security set up, Microsoft supported Windows operating systems are acceptable. See some examples shown below:

- Microsoft® Windows™ Server 2008 (Standard Edition), Service Pack 2
- Windows 10 Enterprise, Service Pack 1

Applications

Configuration of the Gateway is done through a secure web interface. Recent versions of the following browsers are supported:

- Chrome™ browser
- Mozilla Firefox®
- Microsoft Edge

Hard disk space - (*WirelessHART*® only)

- AMS Wireless Configurator: 1.5 GB
- Gateway Security Setup CD: 250 MB

2.3 Initial connection and configuration

Initial connection

To configure the Gateway, a local connection between a computer and the Gateway needs to be established. The *WirelessHART*® and ISA100 networks in the Emerson 1410S Gateway are operationally equivalent and the following instructions are applicable to both.

Powering the Gateway

For the Emerson 1410S, bench top power will be needed to power the Gateway by wiring a 10.5–30 Vdc (24 Vdc if configured with I.S. barriers) power source. See [Power specifications](#) for power requirements or [Reference data](#) for specifications.

Figure 2-1: Emerson 1410S Gateway Wiring

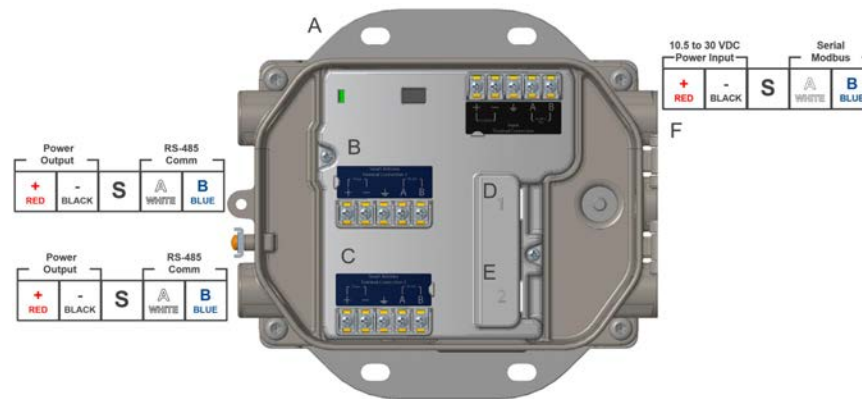

- A. Mounting plate
- B. Emerson Wireless 781S Smart Antenna terminal 1 power and data connections
- C. Emerson Wireless 781S Smart Antenna terminal 2 power and data connections
- D. Ethernet port 1. When this port is activated, the factory IP address is 192.168.1.10.
- E. Ethernet port 2. When this port is activated, the factory IP address is 192.168.2.10.
- F. Emerson 1410S power and serial connections

⚠ CAUTION

Equipment damage

Connecting through the open terminal block cover may stress the connections and damage the Gateway.

When making physical connections to the Gateway, the installer should route wire for the Emerson 781S units through the left side entries using a separate entry for each. Power, Ethernet, and serial Modbus® wiring should be routed through the right side wiring entries.

2.3.1 Establishing a connection

Connect the PC/laptop to the Ethernet 1 (Primary) receptacle on the Gateway using an Ethernet cable. This process will only need to be done once for the two networks. The networks have the same IP address even if you are running two separate networks.

2.3.2 Windows® 7

Procedure

1. Click the **Internet Access icon** on the bottom right of the screen.

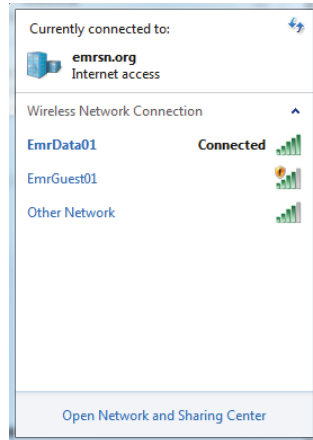

2. Select the **Network and Sharing Center**.
3. Select **Local Area Connection**.

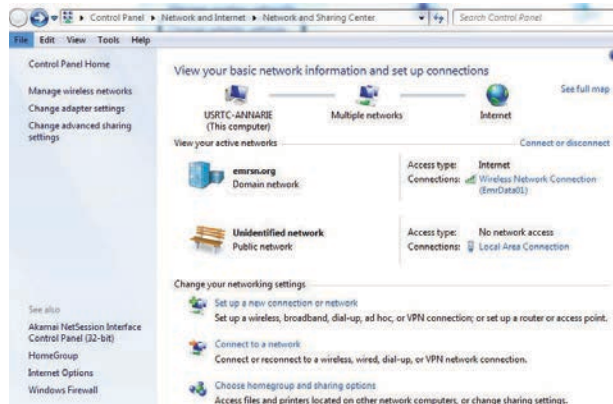

4. Select **Properties**.
5. Select **Internet Protocol Version 4 (TCP/IPv4)** → **Properties**.

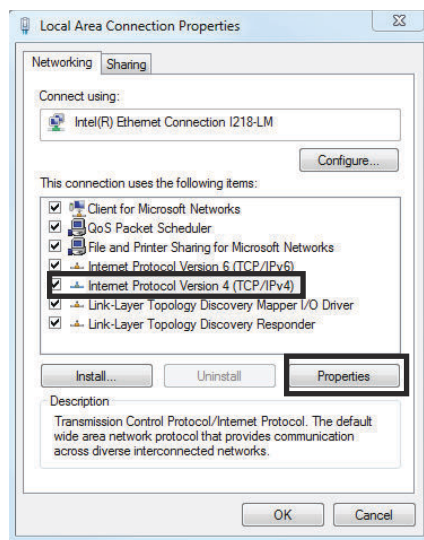

Note

If the PC/laptop is from another network, record the current IP address and other settings so the PC/laptop can be returned to the original network after the Gateway has been configured.

6. Select the **Use the following IP address** button.



7. In the **IP address** field, enter 192.168.1.12 (DeltaV Ready enter 10.5.255.12).
8. In the **Subnet mask** field, enter 255.255.255.0.
9. Select **OK** for both the **Internet Protocol (TCP/IP) Properties** window and the **Local Area Connection Properties** window.

2.3.3 Windows™ 10

Procedure

1. Select the network icon in the lower right corner of the Windows 10 workspace.
2. Select **Network & Internet Settings**.

Figure 2-2: WiFi Connections Menu

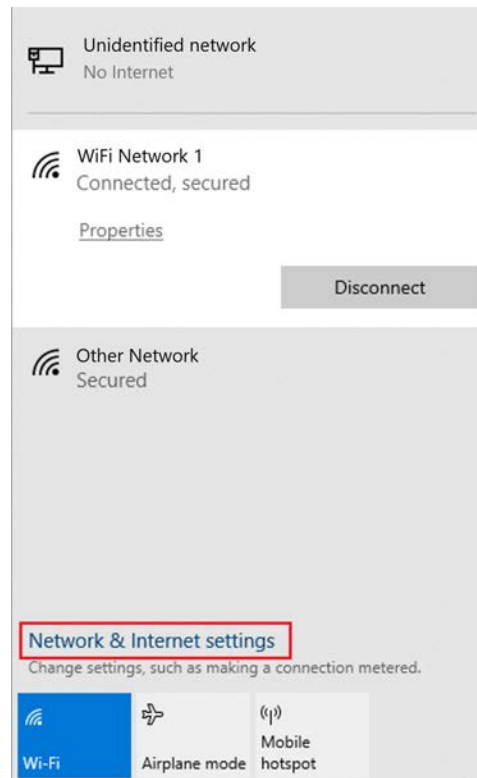

3. Select **Change adapter options**.

Figure 2-3: Network & Internet Settings

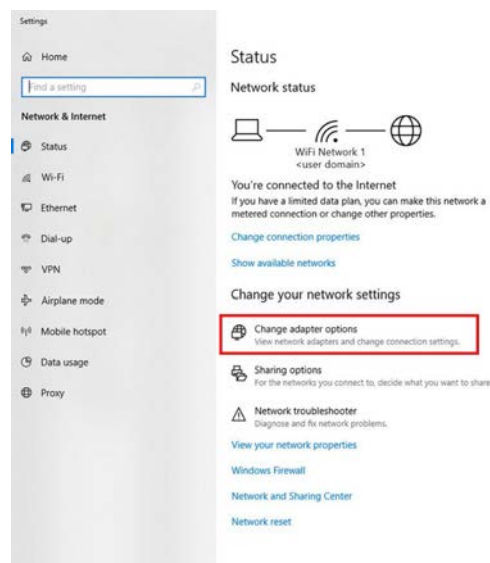

4. Right click the network interface connection that the gateway is plugged into, and select **Properties**.

5. Select **Internet Protocol Version 4 (TCP/IPv4)** → **Properties**.

Figure 2-4: Ethernet properties

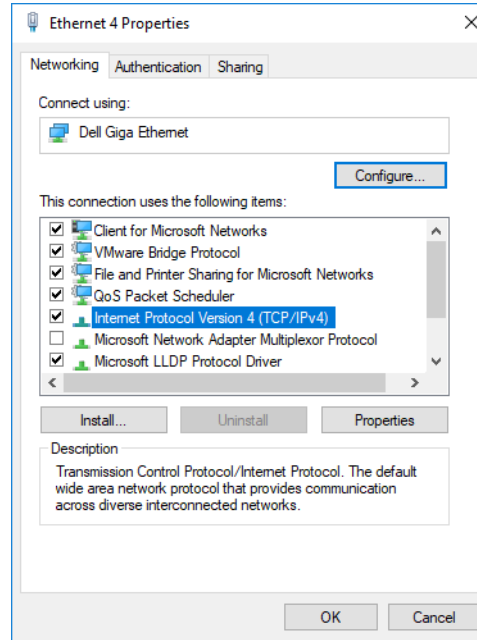

Note

If the PC/laptop is from another network, record the current IP address and other settings so the PC/laptop can be returned to the original network after the gateway has been configured.

6. Select the **Use the following IP address** button.

Figure 2-5: IP Address Properties

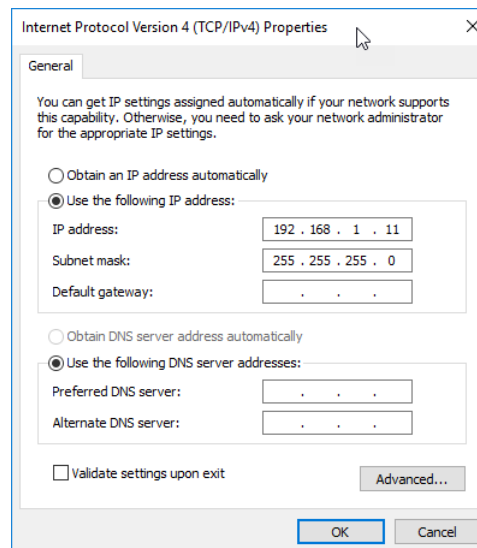

7. In the **IP Address** field, enter 192.168.1.11.

8. In the **Subnet mask** field, enter 255.255.255.0.
9. Select **OK** for both the **Internet Protocol (TCP/IP) Properties** window and the **Local Area Connection Properties** window.

Note

Connecting to the gateway's secondary Ethernet port will require different network settings.

Table 2-1: Network Settings

Ethernet	Gateway	PC/laptop/tablet	Subnet
1	192.168.1.10	192.168.1.11	255.255.255.0
2	192.168.2.10	192.168.2.11	

2.3.4 Disable proxies

Use these steps to disable proxies.

Procedure

1. Open web browser.
2. Navigate to **Tools** → **Internet Options** → **Connections** → **LAN Settings** (may be a different process for other browsers).

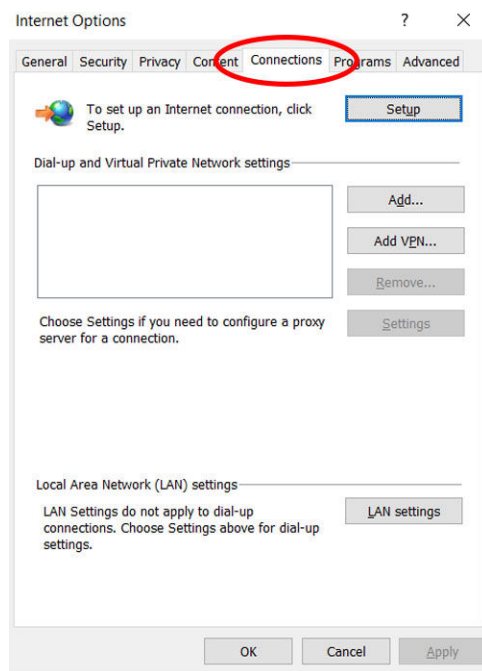

3. Under **Proxy server**, uncheck the **Use a proxy server...** box.

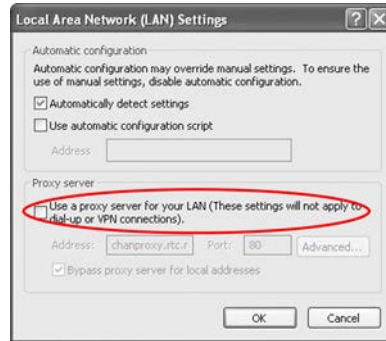

2.3.5 Configure the Gateway

Use these steps to complete the initial configuration for the Gateway. This will need to be done for both the *WirelessHART*[®] and ISA100 networks.

Procedure

1. Access the **WirelessHART** default web page for the Gateway at [https:// 192.168.1.10](https://192.168.1.10). You will have to configure both networks individually.
 - a) Log on as Username: admin
 - b) Type in password: default

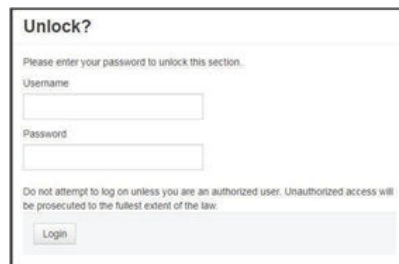

2. Navigate to **System Settings** → **Gateway** → **Ethernet Communication** to enter the network settings.
 - a) Configure a static IP Address or set for DHCP and enter a Hostname.

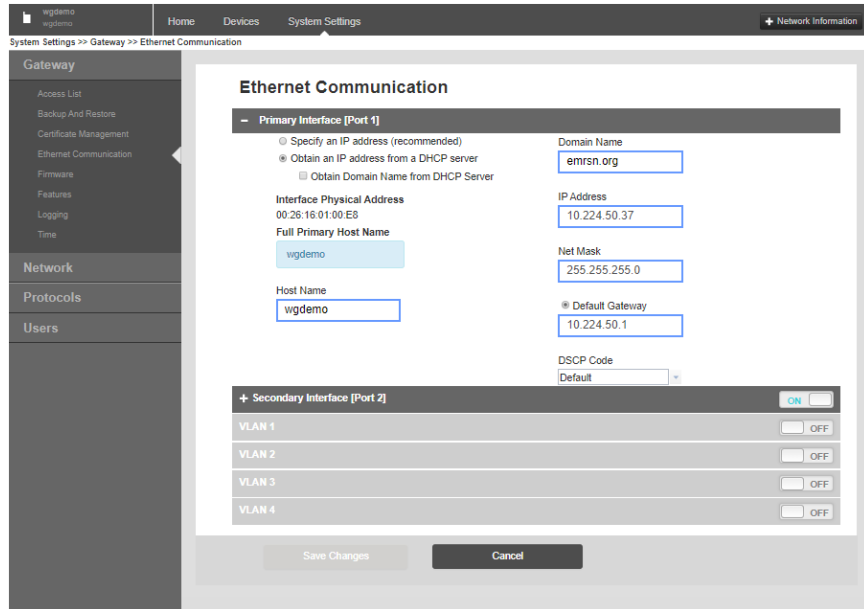

b) If not prompted, restart application at **System Settings** → **Gateway** → **Backup and Restore** → **Restart Apps**.

Note

Resetting applications will temporarily disable communications with field devices.

2.3.6 User accounts

There are four role-based user accounts for the Gateway with varying levels of access. The access can be changed on the **System Settings** → **Users** → **User Accounts** by the admin user. The figure below displays this access.

Figure 2-6: User Privileges

Admin Privileges	Executive	Operator	Maintainer
Certificate Management	<input type="checkbox"/>	<input type="checkbox"/>	<input type="checkbox"/>
Change ACL Settings	<input type="checkbox"/>	<input type="checkbox"/>	<input checked="" type="checkbox"/>
Change EtherNet/IP Settings	<input type="checkbox"/>	<input type="checkbox"/>	<input checked="" type="checkbox"/>
Change IP Address	<input type="checkbox"/>	<input type="checkbox"/>	<input type="checkbox"/>
Change Modbus Settings	<input type="checkbox"/>	<input type="checkbox"/>	<input checked="" type="checkbox"/>
Change OPC Settings	<input type="checkbox"/>	<input type="checkbox"/>	<input checked="" type="checkbox"/>
Change Protocols and Ports	<input type="checkbox"/>	<input type="checkbox"/>	<input type="checkbox"/>
Change Time Settings	<input type="checkbox"/>	<input type="checkbox"/>	<input type="checkbox"/>
Delete Inactive Devices	<input type="checkbox"/>	<input checked="" type="checkbox"/>	<input checked="" type="checkbox"/>
Edit HART Details	<input type="checkbox"/>	<input type="checkbox"/>	<input checked="" type="checkbox"/>
Enable Logging	<input type="checkbox"/>	<input type="checkbox"/>	<input type="checkbox"/>
Reset To Default	<input type="checkbox"/>	<input type="checkbox"/>	<input type="checkbox"/>
Restart The Gateway	<input type="checkbox"/>	<input type="checkbox"/>	<input type="checkbox"/>
Restore Backup	<input type="checkbox"/>	<input type="checkbox"/>	<input type="checkbox"/>
Save Backup	<input type="checkbox"/>	<input type="checkbox"/>	<input type="checkbox"/>
Upgrade Features	<input type="checkbox"/>	<input type="checkbox"/>	<input type="checkbox"/>
Upgrade Firmware	<input type="checkbox"/>	<input type="checkbox"/>	<input type="checkbox"/>
View HART Gateway Details	<input type="checkbox"/>	<input type="checkbox"/>	<input type="checkbox"/>
View Network Settings	<input type="checkbox"/>	<input type="checkbox"/>	<input type="checkbox"/>

Save Changes Cancel

2.3.7 Change passwords

It is a secure practice to change the user account passwords from the default ones. Perform this task on both the *WirelessHART*[®] and ISA100 networks. To change the User Account passwords, follow the steps below.

Procedure

1. Navigate to **System Settings** → **Users** → **User Accounts**.
2. Click the **Edit** button of the user password to be changed.
3. Set the new password for the role based account, and confirm.
4. Select **Save Changes**.

Note

It is suggested the default security settings in **System Settings** → **Users** → **User Options** be changed to the local IT best practices or the "Normal" setting after initial login. Strong or custom settings are available for more robust passwords.

2.3.8 Time settings

The Gateway is the timekeeper for the *WirelessHART*[®] network, so it is imperative the Gateway's time is accurate for timestamp data to be meaningful. Time settings can be found by navigating to **System Settings** → **Gateway** → **Time** as shown in *Windows*[®] 7. Any changes made to the time settings will have to be done to both networks for consistency. There are three ways to set the Gateway time:

Procedure

1. Network Time Protocol (recommended). This option uses a Network Time Protocol (NTP) server to adjust the Gateway's time to match the time of the control network.
 - a) Enter the IP address for the NTP server.
 - b) Select the packet version (i.e. 1, 2, 3, or 4).
2. Set with PC Time. This option will match the Gateway's time to the PC/Laptop.
3. Manual Entry. This option allows the user to enter a specific date (MM:DD:YY) and time (HH:MM:SS).

Note

Network Time Protocol (NTP) is recommended for the best network performance because it always adjusts time to match the network time server.

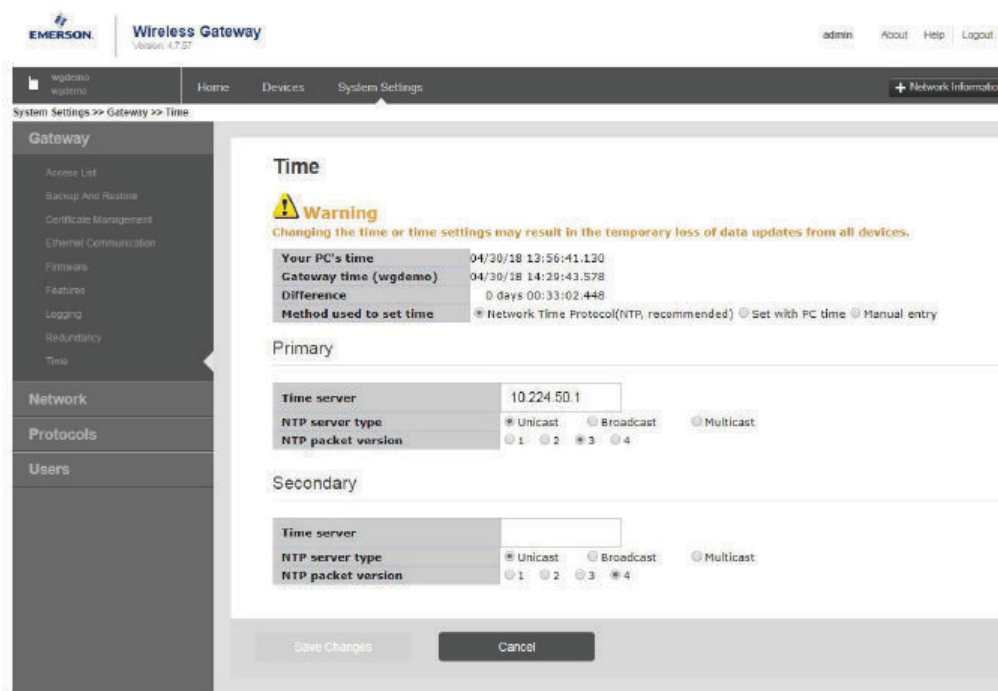

2.3.9 To change the TCP/IP network settings

Procedure

1. Navigate to **System Settings** → **Gateway** → **Ethernet Communication**.
2. Select **Specify an IP address** (recommended).
3. Enter the following:

- Hostname
 - Domain name
 - IP Address
 - Netmask
 - Gateway
4. Select **Save Changes**.
 5. When prompted, select **Restart Apps**.
 6. Select **Yes** to confirm restart.
 7. Close the web browser.

Note

Once the IP Address of the Gateway has been changed, communications to the web interface will be lost. Restart the web browser, then log back into the Gateway using the new IP address and other TCP/IP network settings. The PC/Laptop TCP/IP network settings may need to be changed. During a restart, the wireless network will be temporarily lost.

2.3.10 System backup

The Gateway has a System Backup and Restore feature that saves all user-configured data. It is best practice to periodically perform a System Backup throughout the installation and configuration process. Starting with firmware version 4.7.53, a passphrase is required when taking a backup. The passphrase is used to encrypt and decrypt the backup. This will need to be done two times, for both the *WirelessHART*[®] and ISA100 networks.

Procedure

1. Navigate to **System Settings** → **Gateway** → **Backup and Restore**.
2. Enter a passphrase, confirm, and select **Save Backup**.
The Gateway collects the configuration date.
3. When the file download pop up appears, select **Save**.
4. Enter a save location and file name.
5. Select **Save**.
6. Select **Return to form**.

Note

System Backup contains user passwords and keys used for encrypting communication. Store downloaded system backups in a secure location. The actual files are also encrypted.

2.3.11 Web page usage

Rosemount does not recommended users stay logged on to a single page or a large number of users on multiple pages for long periods of time. The additional loading can slow the flow of data. By default, the Gateway logs users out after a long period of time with no activity.

2.3.12 Resetting to factory defaults

If the user name, password, or IP address of the Gateway is lost, restore the Gateway to factory defaults using the procedure below.

Note

Following this procedure will cause the network to reform and all configuration parameters will be reset to factory defaults. Once the Gateway is reset, the user is strongly recommended to change the default password to maintain system security.

Procedure

1. Turn off power to the Gateway.
2. Locate the **Reset** switch.
For the Emerson 1410S2 modular housing, the switch is located inside the Gateway housing cover on the DIP switch panel board. The reset switch is labeled **switch 4**.
3. Slide the switch to the "ON" position.
4. Reconnect the Gateway; turn power on to the Gateway.
5. Let the Gateway completely boot up (approximately three minutes).
During this time, the red reset light on the front of the unit will be on.
6. Turn off power to the Gateway again.
7. Return the **Reset** switch to the "OFF" position.
8. Mount and reconnect the Gateway; restore power to the Gateway.
9. Verify the **Reset** switch is in the "OFF" position.
The Gateway will now be programmed back to factory defaults including IP addresses. See [Initial connection: Web browser returns "page not found"](#) for factory default IP addresses.

Figure 2-7: DIP Switch Identification

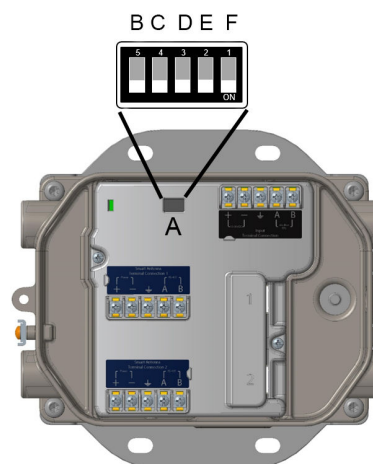

- A. DIP switches
- B. PoE disabled
- C. Reset to defaults
- D. 1.5 k Ω pull-down resistor
- E. 120 Ω terminating resistor
- F. 1.5 k Ω pull-up resistor

3 Installing the Gateway

3.1 Emerson Gateway 1410S2 installation overview

This section describes how to properly mount the Emerson 1410S2 Gateway and make electrical connections including wiring, grounding, and host system connections.

General considerations

- Mount the Gateway in any general-purpose location.
- Ensure gasket between the Gateway cover and housing is in place and undamaged.
- Ensure cover is secured tightly to prevent exposure of any electronics to moisture and contamination.
- Ensure cover is secured tightly and all used and unused wiring entries are sealed to prevent exposure of electronics to any moisture or contamination.
- Mount the Gateway in a location allowing convenient access to the host system network (process control network).
- Best practice is to install the Emerson 781S Smart Antennas centrally in the wireless network for the most direct connections to the Gateway.

Physical description

For dimensional drawing information, refer to [Reference data](#). The rugged modular Emerson 1410S2 Gateway electronics are enclosed in an aluminum housing. The conduit entries in the enclosure have connections for power, Ethernet, serial and Emerson 781S communications. The unit is designed to be modular and mountable to a pole or the Cisco® IW6300 Access Point.

3.2 Power specifications

Table 3-1: Emerson 1410S Gateway Power

Gateway version	Non-barrier	Barrier
Input voltage	10.5 to 30 Vdc	24 Vdc
Power consumption	5 Watts	7.5 Watts
	At start-up, the power supply must be capable of momentarily sourcing at least twice the operating current. The Gateway may draw significantly more current momentarily at start-up if not limited by the power supply.	
Power over Ethernet (PoE)	Gateway supports IEEE 802.11 PoE as a Powered Device (PD) on either port.	
Input and output connections	In: DC power (2-wire, 1 connection) Out: DC Power (2-wire, 2 connections) I/O: RS-485 (2-wire, 2 connections)	

The Gateway is designed to be powered by 24 Vdc (nominal) Class 2 supply and requires 350 mA of current.

The wiring requires an external power shut-off switch or circuit breaker positioned near the Gateway.

The terminals on this connector can accommodate wires from 24 AWG to 12 AWG; 18 AWG wire is recommended. Tighten screws to 4.4 to 5.3 lbf-in (0.5 to 0.6 Nm).

In ambient temperatures greater than 60 °C, use wire rated for at least 5 °C above the maximum ambient temperature.

Note

Using an uninterruptible power supply (UPS) is recommended to ensure availability during power failure.

NOTICE

The Emerson 781S was designed for use with the Emerson 1410S Gateway and should only be connected to the Emerson 1410S and/or other Emerson Gateway products.

Table 3-2: Emerson 781S Smart Antenna Power

Emerson Smart Antenna model version	781SA	781SC
Input voltage	10.5 to 30 Vdc	
Power consumption	0.25 W	0.30 W
Radio protocol	IEC 62591 (<i>WirelessHART</i> [®])	IEC 62734 (ISA100)
EIRP (Max)	781SA (<i>WirelessHART</i>) - 16 dBm 781SC (IEC 62734) - 10 dBm	
Antenna options	Integrated omni-directional antenna	
Input and output connections	In: DC power (2-wire) I/O: RS-485 (2-wire)	

3.3 Mounting the Emerson 1410S2 Gateway

Find a location where the Gateway has convenient access to the host system network (process control network).

3.3.1 Pipe mount

Pipe mount

The following hardware and tools are needed to mount the Gateway to a 2-inch pipe:

- Two 5/16-inch u-bolts (supplied with Gateway)
- 2-inch mounting pipe
- ½-inch socket-head wrench
 1. Secure the u-bolt around the pole at the appropriate height you want the Gateway to be secured.
 2. Using a ½-inch. socket-head wrench, secure the Gateway to the pole with two u-bolts assemblies and four 15/16-inch nuts.

Figure 3-1: Pipe Mount

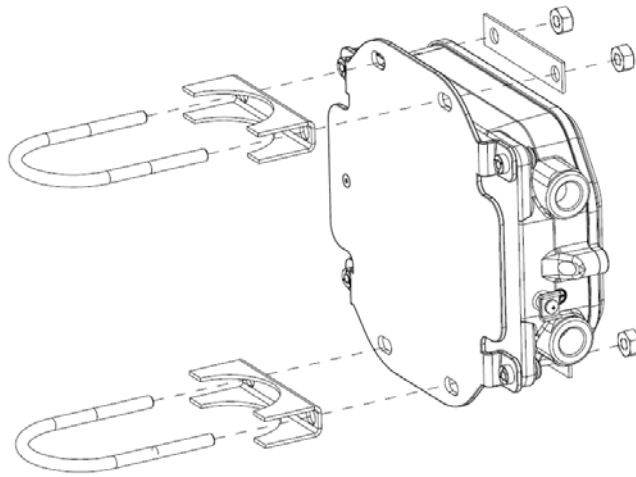

3.3.2 1410S2 Surface mount

The following hardware and tools are needed to surface mount the Gateway to a support bracket:

Prerequisites

- Four appropriate fasteners for preferred mounting method
- Mounting plate (supplied with gateway)
- Drill (not supplied)
- Wrench (not supplied)

Mount the gateway using the following procedure:

Procedure

Install gateway into surface as shown in [Figure 3-2](#). Screws shown as example.

Figure 3-2: Emerson 1410S2 Surface Mounting

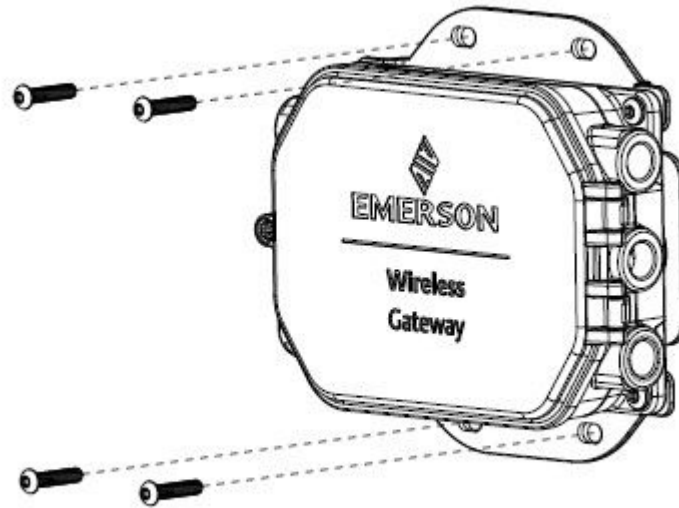

3.4 Mounting the Emerson 781S Smart Antenna

Intended use

The Smart Antenna must be used in conjunction with a network manager or network Gateway. The Smart Antenna then functions as a translator between the wired network and a wireless field network. [Figure 3-3](#) shows one of the networks being used.

Figure 3-3: System Architecture Example

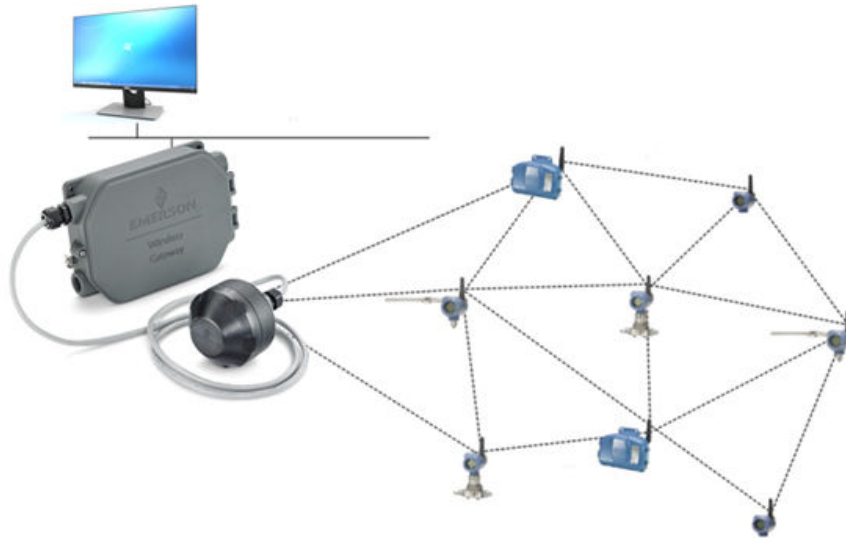

Mounting location

Mount the Emerson Smart Antenna in a location allowing convenient access to the host system network (wireless I/O) as well as the wireless field device network. Find a location where the Smart Antenna has optimal wireless performance. Ideally this will be 15-25 ft. (4.6-7.6 m) above the ground or 6 ft. (2 m) above obstructions or major infrastructure. If the Gateway is using two Emerson 781S Smart Antennas, they do not need to be installed near each other. There should be at least 3 ft. (1 m) of separation between the two antennas.

Figure 3-4: Mounting Location

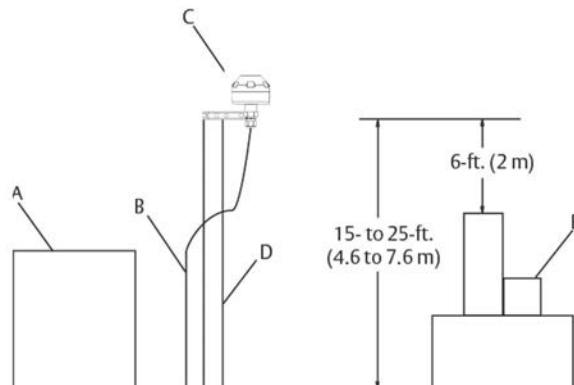

- A. Control room
- B. RS-485 cable
- C. Smart Antenna
- D. Mast or pipe
- E. Infrastructure

3.4.1 Emerson Smart Antenna pipe mount

Procedure

1. Insert U-bolt around 2inch pipe/mast, through the saddle, through the L-shaped bracket, and through the washer plate.
2. Use a ½-inch socket-head wrench to fasten the nuts to the U-bolt.
3. Insert single bolt through L-shaped bracket into the antenna.
4. Use a 5/16-inch socket-head wrench to fasten bolt to bracket.

3.4.2 Antenna position

The Emerson 781S Smart Antenna is an omni-directional antenna not requiring specific horizontal positioning for optimal network connectivity. Mount the antenna vertically upright in the center of the network for the most direct device connections to the Gateway.

3.5 Connecting the Emerson 1410S to the 781S Smart Antennas

There are two main connection configurations for the Emerson 1410S and 781S Smart Antennas: with and without intrinsically safe barriers. The hazardous location approval option of the Emerson 781S determines whether it needs to be installed with barriers. This connection is integrated in the Gateway electronics and can be selected upon order. Selecting the IS barrier option will provide IS barriers integrated into the Gateway. This will provide intrinsic safety and approval for Emerson 781S installation in Div 1/Zone 0 areas. For more information on product approvals, see [Reference data](#).

The Gateway enclosure acts as a junction box for wiring connections. The enclosure has five conduit entries for power and communications wiring. Do not run communication near heavy electrical equipment.

Install the included conduit plugs in any unused conduit openings. For NEMA® 4X and IP65 requirements, use thread seal (PTFE) tape or paste on male threads to provide a watertight seal.

3.5.1 Emerson 1410S grounding

The DIN-rail mounted Emerson 1410S1 Gateway does not require an external ground because the back DIN mounting plate is already grounded.

The rugged modular Emerson 1410S2 Gateway enclosure case should always be grounded in accordance with national and local electrical codes. The most effective grounding method is a direct connection to earth ground with minimal impedance. Ground the Gateway by connecting the external grounding lug to earth ground. The connection should be 1 Ω or less. The external ground plug is located on the left side of the Gateway enclosure and is identified by the following symbol:



3.5.2 Ethernet

The Gateway is equipped with two 10/100BaseTX Ethernet communications ports (see [Emerson 781S installation](#)). These connections can be used to access the Gateway's web interface and to communicate using other available protocols.

The primary Ethernet port (Ethernet 1) is used to connect to the host system or other application systems. The secondary Ethernet port (Ethernet 2) can be used as a backup connection or a maintenance port for local access to the Gateway.

3.5.3 Emerson 781S installation

A shielded twisted-pair cable is needed for connecting the Emerson 1410S and each 781S Smart Antennas. Each antenna can be located up to 1312 ft. (400 m) from the Gateway.

Figure 3-5: Emerson 1410S Gateway and Single 781S Smart Antenna

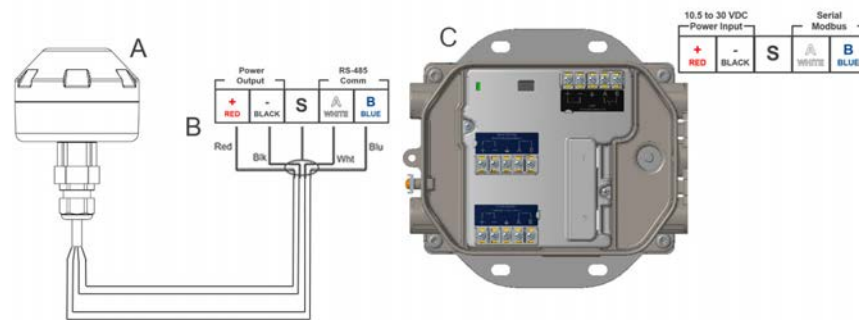

- A. Emerson Wireless 781S Smart Antenna
- B. Attach shield pair cable (Belden 3084A or equivalent)
Tape back shield wire and foils if connecting through a junction box between the Emerson 781S and 1410S Gateway.
- C. Emerson Wireless 1410S Gateway

Figure 3-6: Emerson 1410S Gateway and Two 781S Smart Antennas

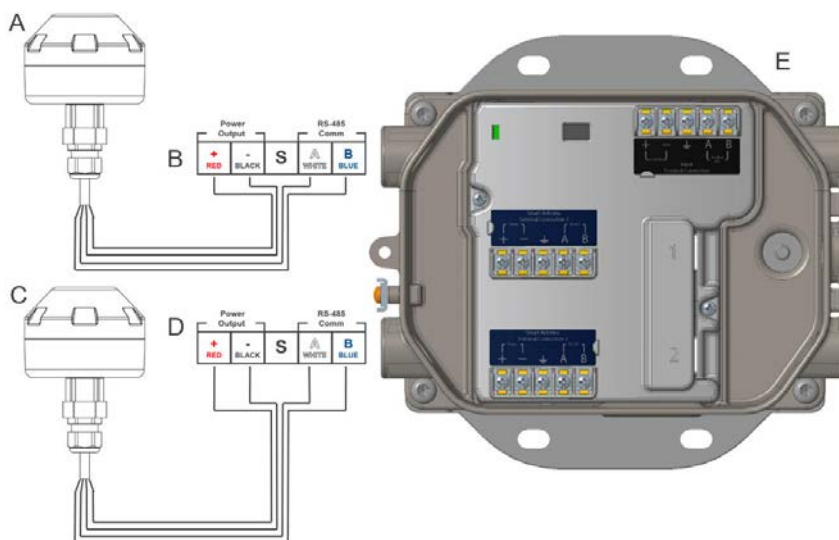

- A. Emerson WirelessHART® 781S Smart Antenna
- B. Attach shield pair cable (Belden 3084A or equivalent)
- C. Optional secondary Emerson Wireless 781S Smart Antenna
- D. Tape back shield wire and foils
- E. Emerson Wireless 1410S Gateway

3.5.4 RS-485

The Gateway can be ordered with an optional RS-485 (serial) connection (see [Figure 3-5](#)). Modbus® terminals are labeled A and B on the wiring diagram. This connection is used to communicate Modbus RTU on an RS-485 data bus.

Use 18 AWG single twisted shielded pair wiring to connect the Gateway to the RS-485 data bus. Ensure the total bus length does not exceed 4000 ft. (1220 m). Connect the Tx - (negative, receive) wire to terminal A and the Rx + (positive, transmit) wire to terminal B. Trim the wiring shield close and use insulation to prevent it from touching either the Gateway enclosure or other terminations.

If the existing data bus uses a 4-wire Full Duplex configuration, see [Figure 3-7](#) to convert to a 2-wire Half Duplex configuration.

Figure 3-7: Convert from Full to Half Duplex

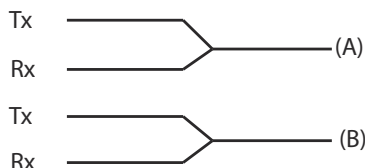

3.5.5 Shield grounding

The shields of the twisted-pair cables need to be grounded using the grounding terminal on the Emerson 1410S.

3.5.6 Terminating resistors

Three of the five DIP switches are provided to enable various terminating and biasing resistors to the RS-485 (Modbus®) data bus. The switches are found inside the electronics housing, located in the square opening of the shroud on the upper left side (Figure 3-8). The switches number left to right going down from 5 to 1. The downward position on the switch is **ON**.

Three DIP switches are provided to enable various terminating resistors to the RS-485 data bus. The terminating resistor on the Emerson 781S connection (120 ohm) is always enabled.

Figure 3-8: DIP Switch Identification

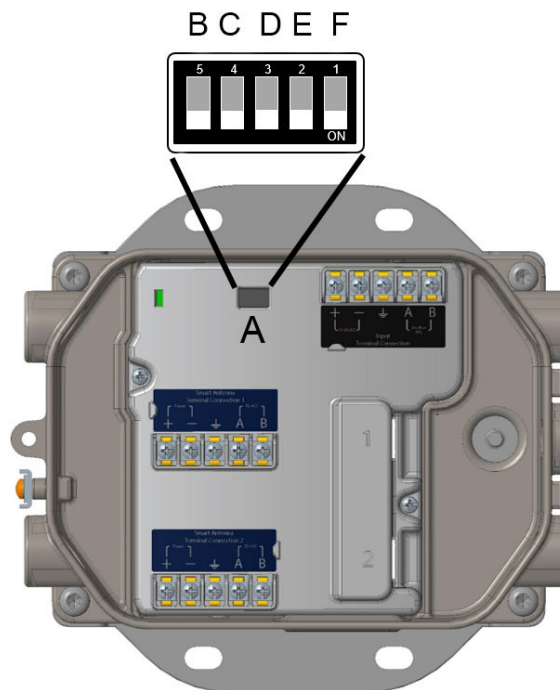

- A. DIP switches
- B. PoE disabled
- C. Reset to defaults
- D. 1.5 k Ω pull-down resistor
- E. 120 Ω terminating resistor
- F. 1.5 k Ω pull-up resistor

Switches 1 and 3 are connected to pull-up and pull-down resistors for Modbus connection. Switch 1 is for the Tx + (A) line and Switch 3 is for the Rx - (B) line. These 1.5 k Ω resistors are used to prevent noise from being interpreted as valid communications during periods when no actual communications are occurring. Ensure that only one set of pull-up and pull-down resistors is active on the RS-485 data bus at a time.

Switch 2 is connected to a 120 Ω terminating resistor for Modbus connection. This resistor is used to dampen signal reflections on long cable runs. RS-485 specifications indicate the data bus should be terminated at both ends (Figure 3-8).

3.5.7 Power over Ethernet (PoE)

This Gateway is equipped with PoE technology to derive its power from another PoE device via the Ethernet connection (PD mode). This device complies with the IEEE 802.3af-2003 or IEEE 802.3at -2009 for PD operation.

These standards require the use of Category 5 Ethernet cable or higher. In the operation of IEEE 802.3a, PoE power is only transmitted from one device to another when the proper impedance match is made. This prevents damage to non PoE devices on the network.

To use this feature, the Gateway must be connected over the Ethernet to a matching IEEE 802.3a device. Failure to do this will cause no power sourced. A switch on the power supply board allows a PD (Powered Device) to be enabled or disabled.

PoE advantages

To save costs on planning, wiring and installation of networks, devices are supplied with power directly via the Ethernet cable (e.g. via a Cat 5/5e cable up to 100 m). PoE makes the network planning flexible, independent of power supply cabinets, and junction boxes. There are no extra costs for the electrical wiring. An advantage of PoE is that you can install devices with an Ethernet interface in places of difficult access or in areas in which running cable would be inconvenient. This in turn saves installation time and costs. This technology is in use today typically in IP telephones, cameras, or wireless transmission devices such as WLAN Access Points.

An excellent application is a Gateway connected to a Wi-Fi back haul unit; such as a Cisco® unit. For example, a Cisco IW6300 unit could power the Gateway over a PoE connection.

Selecting devices to work with a PoE Gateway

When connecting the Gateway to a PSE device, the device must be labeled as compliant with IEEE 802.3af or IEEE 802.3at. Many companies use labels on their packaging such as PoE for IEEE 802.3af or PoE+ for IEEE 802.3at. Check the specific manufacturer's specifications of any device to make sure IEEE 802.3 is referenced; otherwise the connection may not work.

Caution is needed in selecting a companion device to the Gateway for PoE. Not all devices labeled PoE will function. Before 2003, there was no standard and companies developed their own techniques for powering over an Ethernet cable. These techniques are not always interoperable. Before the standard, they used the term **PoE** on many of their products. Most new products labeled PoE are IEEE compatible. Cisco products can be ordered with their old standard (Online Power as it is sometimes referred to) or with the IEEE 802.3 PoE standard. If in doubt, check with the appropriate manufacturer before purchasing/installing the connecting equipment.

For reference, Cisco offers the following four versions:

1. Pre standard PoE (Online Power)
2. 802.3af-compliant PoE (15W)
3. 802.3at-compliant PoE Plus (PoE+) (25W)
4. Universal PoE (UPoE) (60W). (New Cisco standard, which Cisco claims is compatible with IEEE 802.3af PoE and IEEE 802.3at PoE +)

NOTICE

IEEE 802.3 PoE gives protection from damaging a computer or another piece of equipment. When using IEEE 802.3 PoE, one of the important new features of this standard is that PSE devices have a test mechanism to protect connected incompatible devices from being damaged. Only devices which have an authenticating characteristic based on the IEEE 802.3 standard, receive power via the Ethernet cable. To determine whether a PD is connected, the input parameters are checked by the PSE. This method is called "Resistive Power Discovery". During the discovery process resistance, capacitance, and current are checked.

If the PSE detects a PD, it starts classification (i.e. determination of the power requirement of the connected device). The PSE applies a small defined voltage to the power input of the PD's and measures the resulting current. The PD is assigned to a power class based on the value of the current. Only now the total voltage is supplied to the power input.

This sophisticated system prevents computers and other devices from being damaged when connected to these cables.

PoE FAQs

- What do I have to do to order IEEE PoE on a 1410S Gateway?** There is no specific option code for PoE. All 1410S Gateways have PoE. The only configuration needed is to flip DIP switch 5. Turning the switch "ON" means to disable PoE.
- What is the maximum Voltage PoE PSE can source?** Maximum voltage is normally 48 Vdc; up to 25 Watts.
- Can you do redundant power with PoE?** Yes, as PoE becomes more popular many network appliance (switch) providers are supplying innovative switches and other hardware to create redundantly powered networks. Typically, many switch suppliers offer switches allowing multiple power inputs. Check your local switch supplier for available configurations. Also, the Gateway will work with a local power supply connected to the power input terminals of the Gateway and as a PD with power coming over the Ethernet at the same time. If both sources are present, the Gateway selects the local power supply first. If the local power fails, the Gateway automatically switches to Ethernet power. When the local power is restored, the Gateway automatically returns to local power.

3.6 Verify operations

Operation is verified through the web interface by opening a web browser from any PC on the host system network and entering the Gateway IP address or DHCP host name in the address bar. If the Gateway has been connected and configured properly, the security alert will be displayed followed by the log in screen. This will need to be done to both the *WirelessHART*[®] and ISA100 networks.

Figure 3-9: Gateway Log In Screen

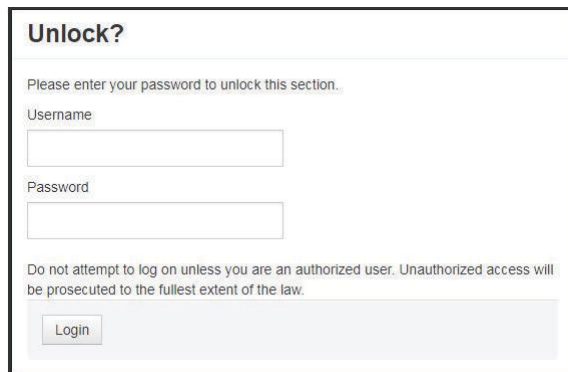

Unlock?

Please enter your password to unlock this section.

Username

Password

Do not attempt to log on unless you are an authorized user. Unauthorized access will be prosecuted to the fullest extent of the law.

The Gateway is now ready to be integrated into the host system. If wireless field devices were ordered with the Gateway, they were preconfigured with the same Network ID and Join Key information. Once the field devices are powered, they will appear on the wireless network and communications can be verified under the Explore tab using the web interface. The time needed for the network to form will depend on the number of devices.

4 Commissioning

4.1 Overview

This section discusses the installation and setup of the optional software included with the Emerson Wireless Gateway. The following table describes what items are installed and on which disk they can be found.

Table 4-1: Software Applications

Name	Description	Location
Security Setup Utility	This utility allows the setup of SSL enabled communications between the Gateway and host system.	Disk 1
AMS Wireless Configurator	This application allows complete configuration of wireless field devices and provides added security through drag and drop provisioning.	Disk 2
Network Configuration	This application configures AMS Wireless Configurator to interface to a wireless network or a HART [®] Modem.	Disk 2

Additional system components may be installed depending on the current configuration of the system.

4.2 System requirements

Table 4-2: PC Hardware

Minimum requirements	Recommended requirements
Intel [®] Core 2 Duo, 2.0 GHz	Intel Core 2 Quad, 2.0 GHz or greater
1 GB Memory	3 GB Memory or Greater
1.5 GB free hard disk space	2 GB or more of free hard disk space

Note

Additional hard disk space is required for SNAP-ON[™] applications. The minimum monitor requirements are 1024 × 768 resolution and 16-bit color.

Table 4-3: Supported Operating Systems

Operating system	Version
Microsoft [®] Windows [™] XP	Professional, Service Pack 3
Windows Server 2003	Standard, Service Pack 2
Windows Server 2003 R2	Standard, Service Pack 2
Windows Server 2008	Standard, Service Pack 2
Windows Server 2008 R2	Standard, Service Pack 1
Windows 7	Professional, Service Pack 1
Windows 7	Enterprise, Service Pack 1
Windows 8	Enterprise, Service Pack 1
Windows Server 2008	Standard, Service Pack 2

Table 4-3: Supported Operating Systems (continued)

Operating system	Version
Windows 10	Enterprise, Service Pack 1

Note

Only 32-bit versions of the operating systems are supported for AMS Wireless Configurator.

4.3 Software installation

The software can be found on the two-disk pack, included with the Gateway. Depending on the PC system configuration, installation may take 30-35 minutes. Installing disk one followed by disk two is recommended. The Security Setup Utility is located on disk 1.

Procedure

1. Exit/close all Microsoft® Windows™ programs, including any running in the background, such as virus scan software.
2. Insert disk 1 into the CD/DVD drive of the PC.
3. Follow the prompts.
AMS Wireless Configurator is located on disk 2. To install the software:
4. Exit/close all Windows programs, including any running in the background, such as virus scan software.
5. Insert disk 2 into the CD/DVD drive of the PC.
6. Select **Install** from the menu when the AMS Wireless Configurator setup begins.
7. Follow the prompts.
8. Allow AMS Wireless Configurator to reboot PC.
9. Do not remove the disk from the CD/DVD drive.
10. Installation will resume automatically after login.
11. Follow the prompts.

Note

If the autorun function is disabled on the PC, or installation does not begin automatically, double click D:\SETUP.EXE (where D is the CD/DVD drive on the PC) and select OK.

4.4 Security setup utility

The Security Setup Utility enables secure communications between the Gateway and host system, asset management software, data historians, or other applications. This is done by encrypting the standard data protocols (AMS Wireless Configurator, Modbus® TCP, and OPC) used by the Gateway and making them available through various proxies within the Security Setup Utility. These proxies can function as a data server for other applications on the control network. The Security Setup Utility can support multiple Gateways at once and each proxy can support multiple client application connects. [Figure 4-1](#) shows a typical system architecture using the Security Setup Utility.

Figure 4-1: Typical Host System Architecture Using Security Setup

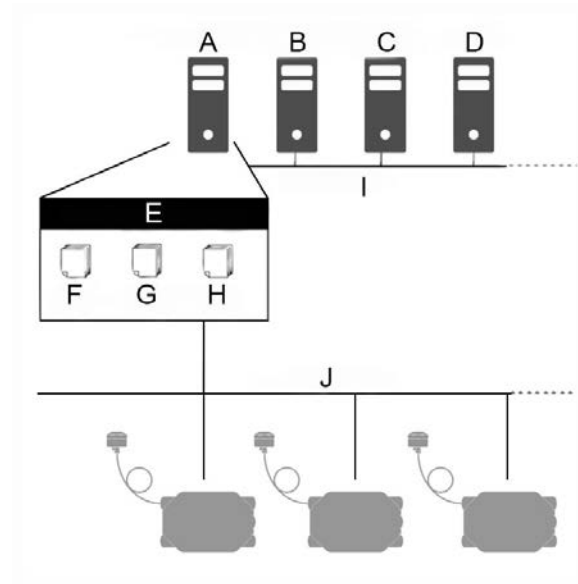

- A. Data server
- B. Engineering station
- C. Asset management
- D. Historian
- E. Security setup utility
- F. AMS proxy
- G. Modbus proxy
- H. OPC proxy
- I. Control network
- J. Encrypted data

Note

OPC communications requires the use of the Security Setup Utility regardless of whether encryption is required.

4.5 AMS Wireless Configurator

AMS Wireless Configurator helps deploy and configure wireless field devices. It provides an HART® integrated operating environment leveraging the full capabilities of *WirelessHART®*, including embedded data trending, charting, and graphical display capabilities provided by enhanced EDDL technology.

- Display and modify device configuration
- View device diagnostics
- View process variables
- Provision a wireless device using the drag-and-drop operation so it can join a Gateway's self-organizing network
- Enhance AMS Wireless Configurator functionality with the AMS Wireless SNAP-ON™ Application

- Restrict access to AMS Wireless Configurator functions through the use of security permissions

See the release notes for information specific to the current release of AMS Wireless Configurator. To display the release notes, navigate to **Start** → **Programs** → **AMS Wireless Configurator** → **Help**.

4.6 Licensing and credits

The latest licensing agreements are included on each disk of the software pack.

This product includes software developed by the OpenSSL Project for use in the [OpenSSL Toolkit](#).

5 Operation and maintenance

5.1 Overview

This section describes how to connect the Gateway to a host system and integrate data gathered from the field device network. It covers network architectures, security, and data mapping.

5.2 Network architecture

Physical connection types are important when determining the network architecture and usable protocols for integration. Ethernet is the primary physical connection type; RS485 is also available. The following network architecture diagrams will help when integrating data from the Gateway into the host system.

Ethernet

An Ethernet connection supports Modbus[®] TCP, OPC, AMS Wireless Configurator, EtherNet/IP,[™] and HART[®] TCP protocols. Using this connection type, the Gateway is wired directly to a control network (see [Figure 5-1](#)) using a network switch, router, or hub.

Figure 5-1: Ethernet Architecture

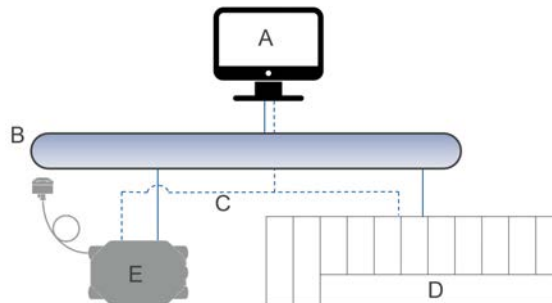

- A. Engineering station
- B. Primary control network
- C. Secondary control network
- D. Controller and I/O
- E. Wireless Gateway

RS485 (serial)

An RS485 connection supports Modbus RTU protocol. Using this connection type, the Gateway is wired to an RS485 bus which typically leads to a serial I/O card or Modbus I/O card ([Figure 5-2](#)). Up to 31 Gateways can be connected to a single I/O card in this manner.

Figure 5-2: RS485 Architecture

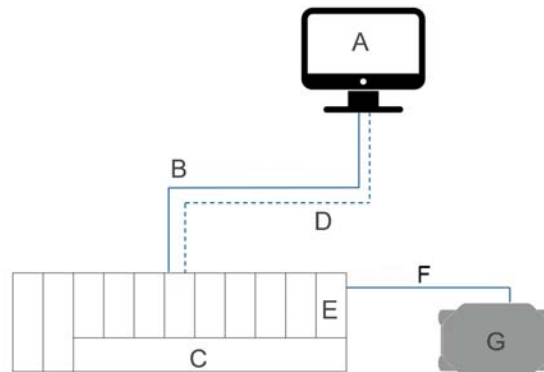

- A. Engineering station
- B. Primary control network
- C. Controller and I/O
- D. Secondary control network
- E. Serial I/O card
- F. RS485 bus
- G. Wireless Gateway

5.3

Modbus®

The Gateway supports both Modbus RTU over the RS-485 serial port and Modbus TCP over Ethernet. It functions as a sub device on the Modbus network and must be polled by a Modbus master or client (host system).

Communication settings

Ensure the Modbus communication settings in the Gateway match the settings in either the Modbus master or the Modbus client. Refer to host system documentation for more information on how to configure these settings. The Modbus communication settings can be found by navigating to **System Settings** → **Protocols** → **Modbus**.

Figure 5-3: Modbus Communications Page

The image shows two stacked configuration panels. The top panel, titled 'Communication Settings', contains several radio buttons and input fields. Under 'Addresses', 'Single Modbus Address' is selected with a value of '1'. 'Baud Rate' is set to '19200' and 'Response Delay Time(ms)' is '0'. For 'Parity', 'Even' is selected. 'Stop Bits' has 'One' selected. Under 'Unmapped Register Read Response?', 'Illegal Data Address' is selected. Under 'Unmapped Register Write Response?', 'Illegal Data Address' is also selected. A 'Save Communication Settings' button is at the bottom. The bottom panel, titled 'Format Settings', has 'Float' selected for 'Floating point representation'. 'Byte Swap' is set to 'Use swapped floating point format?'. Under 'Value reported for error (floating point)', 'NaN' is selected. Under 'Value reported for error (rounded and native integer)', the value '32767' is entered in the input field. A 'Save Format Settings' button is at the bottom.

- Single Modbus Address** When selected, this address is used by the Gateway for Modbus RTU communications.
- Multiple Modbus Addresses** When selected, a new address column will appear on the Modbus mapping page.
- Modbus TCP Port** The TCP/IP port the Gateway uses for Modbus TCP (Ethernet). To change TCP/IP port settings, see the Internal Firewall section for more details.
- Baud Rate** The data rate or speed of serial communications; only required for Modbus RTU.
- Parity** Determines the parity (none, even, or odd) used for error checking purposes; only required for Modbus RTU.
- Stop Bits** Determines the number (1 or 2) of stop bits used when ending a message; only required for Modbus RTU.
- Response delay time (ms)** Determines how long (ms) the Gateway waits before responding to a Modbus request; only required for Modbus RTU.
- Unmapped register read response?** The value returned by the Gateway if the Modbus master requests a register with no data assigned to it (empty register). To prevent errors, Rosemount recommended this value is set to zero.

Floating point representation	<p>Determines whether the Gateway uses floating point values or integer values. There are three options for this setting.</p> <ul style="list-style-type: none">• Float—uses 32 bit floating point values• Round—rounds the data value to the nearest whole number• Scaled—uses scaled integers to offset negative values or increase decimal point resolution. The equation for scaled integers is: $y = Ax - (B - 32768)$Where: y = Scaled integer returned by the Gateway A = Gain for scaled integer value x = Measured value from wireless field device B = Offset for scaled integer value
Use swapped floating point format?	<p>Switches which register is sent first for a floating point value. This setting is only used for floating point values.</p>
Incorporate value's associated status as error?	<p>Causes the Gateway to report a predetermined value when a communications or critical diagnostic error is received from the wireless field device. The value is user configurable depending on which floating point representation is chosen. See Value reported for error below.</p>
Value reported for error (floating point)	<p>Determines what value is reported if the wireless field device reports a failure or stops communicating to the Gateway. This setting is used for floating point values. The choices are NaN (not a number), +Inf (positive infinity), -Inf (negative infinity), or Other (user specified).</p>
Value reported for error (rounded and native integer)	<p>Determines what value is reported if the wireless field device reports a failure or stops communicating to the Gateway. This setting is used for rounded or native integers. The choice is a user specified value between -32768 and 65535.</p>
Scaled floating point maximum integer value	<p>Determines the maximum integer value for the purpose scaling integers. 999-65534.</p>
Use global scale gain and offset?	<p>Determines if a global gain and offset is applied for scaled integers or if each value has a unique gain and offset. Unique gain and offsets are found on the Modbus Mapping page.</p>
Global scale gain	<p>This value is multiplied by the data values for the purpose of scaling integers. If global scaling is not selected, a gain value will be available for each separate data value on the Modbus Mapping page.</p>
Global scale offset	<p>This value is added to the data values for the purpose of scaling integers. If global scaling is not selected, an offset value will be available for each separate data value on the Modbus Mapping page.</p>

5.4 System diagnostic registers with Dual WirelessHART[®] enabled for Modbus[®], Ethernet/IP[™], and OPC[®]-UA

The 1410S has system registers that provide additional insights into Gateway operation. These system registers are not required for standard use.

These variables can be viewed in the Gateway web interface by navigating to **System Settings** → **Protocols** → **Modbus/EthernetIP**, if these protocols are enabled, and clicking the **Show/Hide System Registers** button as shown in [Figure 5-4](#).

For OPC-UA, these variables are automatically mapped to the OPC-UA client and can be viewed from the client system

Figure 5-4: Show/Hide System Registers Modbus Example. Additional registers are available but not shown

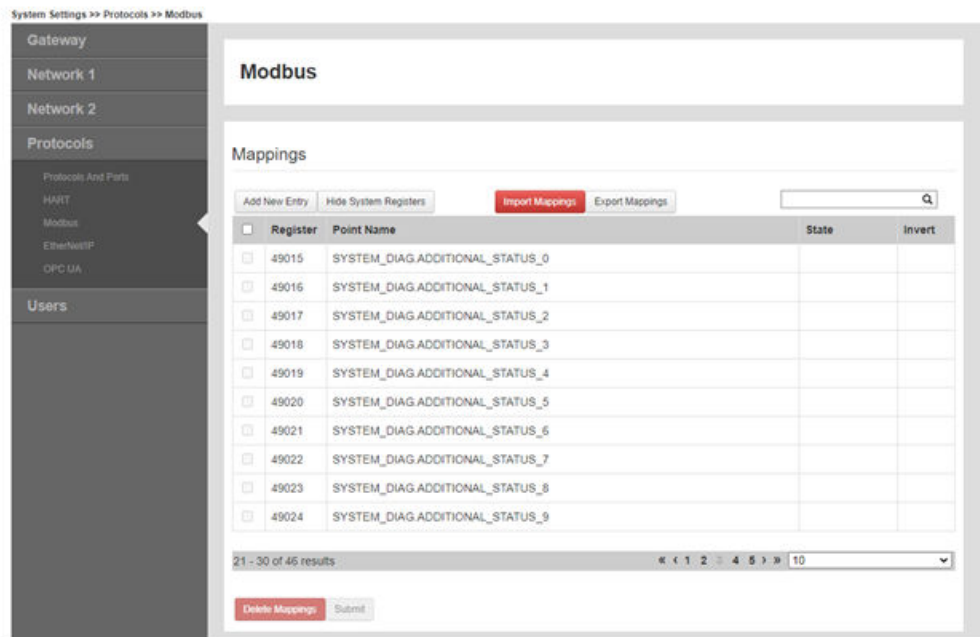

The SYSTEM_DIAG.xxxx variables that are now shown are only associated with WirelessHART Network 1. To map both WirelessHART network's system registers, the same variables as SYSTEM_DIAG.xxxx can be mapped using the HART Tag in place of SYSTEM_DIAG.

Each network's HART Tag can be found by navigating to **System Settings** → **Protocols** → **HART**.

Figure 5-5: HART Settings Page Showing HART Tags for Each Network

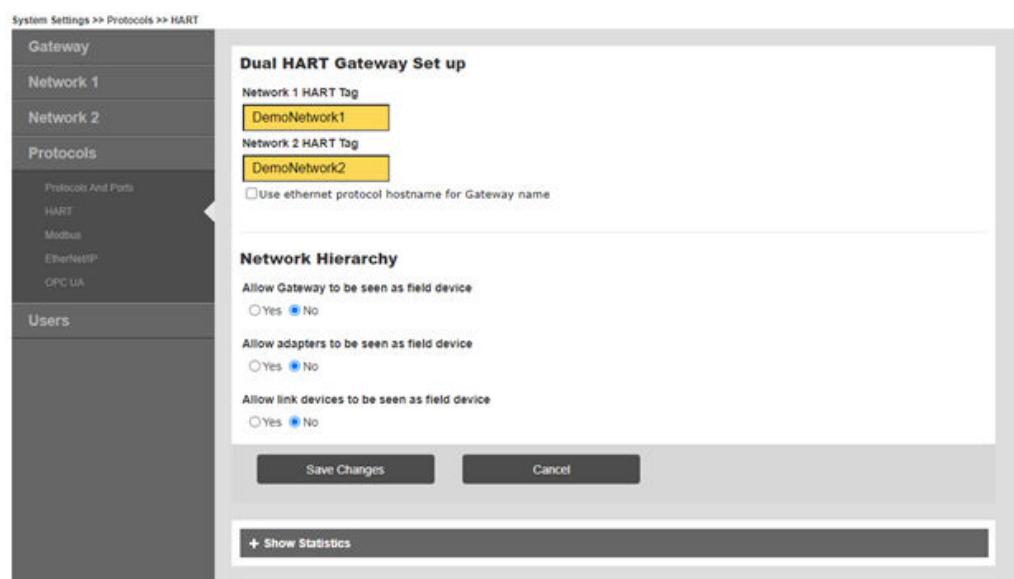

To map system registers for both Network 1 and Network 2, click **Add New Entry** on the Protocols page shown in [Figure 5-4](#) and type in the register needed with the HART Tag name instead of SYSTEM_DIAG.

Network 1 example:

SYSTEM_DIAG.ADDITIONAL_STATUS_0 --> DemoNetwork1.ADDITIONAL_STATUS_0

This maps the ADDITIONAL_STATUS_0 register for Network 1.

Note

SYSTEM_DIAG.xxxx registers can still be used for Network 1.

Network 2 example:

SYSTEM_DIAG.ADDITIONAL_STATUS_0 --> DemoNetwork2.ADDITIONAL_STATUS_0

This maps the ADDITIONAL_STATUS_0 register for Network 2.

Note

SYSTEM_DIAG.xxxx variables cannot be used for Network 2 because those registers will only show values for Network 1.

There are Gateway-specific system registers which can only be mapped using the SYSTEM_DIAG naming convention. For example, SYSTEM_DIAG.UPTIME provides a total sum count of how long the Gateway has been running which can only be mapped with SYSTEM_DIAG and not the individual Network HART Tags.

[Table 5-1](#) below shows what variables are Gateway specific.

Table 5-1: Gateway specific SYSTEM_DIAG Registers

SYSTEM_DIAG.UPTIME
SYSTEM_DIAG.TEST_BOOLEAN
SYSTEM_DIAG.TEST_BYTE
SYSTEM_DIAG.TEST_UNSIGNED_BYTE
SYSTEM_DIAG.TEST_SHORT

Table 5-1: Gateway specific SYSTEM_DIAG Registers (continued)

SYSTEM_DIAG.TEST_UNSIGNED_SHORT
SYSTEM_DIAG.TEST_INT
SYSTEM_DIAG.TEST_UNSIGNED_INT
SYSTEM_DIAG.TEST_FLOAT
SYSTEM_DIAG.DEFAULT_PASSWORD

6 Troubleshooting

6.1 Service support

This section provides basic troubleshooting tips for the Emerson Smart Wireless Field Network. To receive technical support by phone:

Global Service Center

Software and Integration support

United States - 1 800 833 8314

International - 63 2 702 1111

Customer Central

Technical support, quoting, and order-related questions

United States - 1 800 999 9307 (7:00 am to 7:00 pm CST)

Asia Pacific - 65 6777 8211

Europe/Middle East/Africa - 49 (8153) 9390

6.2 Initial connection: Web browser returns "page not found"

Possible cause: Incorrect IP address

Recommended actions

1. Connect the Gateway and PC/laptop.
2. Verify the Gateway is properly powered, 24 Vdc (nominal) and 250 mA.
3. Verify the IP address for the Gateway (default primary port is 192.168.1.10, default secondary port is 192.168.2.10 or for DeltaV™ Ready Gateway's default primary port is 10.5.255.254, default secondary port is 10.9.255.254).
4. Verify the IP address of the PC/laptop is in the same subnet range as the Gateway (i.e. If the Gateway IP is 155.177.0.xxx, then the PC/Lap IP address should be 155.177.0.yyy).

Possible cause: Internet proxy settings

Recommended actions

1. Connect the Gateway and PC/laptop.
2. Verify the Gateway is properly powered, 24 Vdc (nominal) and 250 mA.
3. Disable Internet browser proxy settings.

6.3 Initial connection: Cannot find Gateway after changing IP address

Possible cause: Incorrect IP address

Recommended actions

1. Verify the IP address of the PC/laptop is in the same subnet range as the Gateway (i.e. If Gateway IP address is 155.177.0.xxx, then PC/laptop IP address should be 155.177.0.yyy).
2. Consider resetting the gateway to factory defaults.

6.4 Initial connection: Cannot find Gateway using secondary Ethernet port

Possible cause: Incorrect IP address

Recommended actions

1. Verify which Ethernet port is being used on the Gateway.
2. Verify the Gateway IP address (default primary port is 192.168.1.10, default secondary port is 192.168.2.10).
3. Verify the IP address of the PC/laptop is in the same subnet range as the Gateway (i.e. If Gateway IP address is 155.177.0.xxx, then PC/laptop IP address should be 155.177.0.yyy).
4. Verify this option was ordered with the Gateway.

6.5 Initial connection: Cannot log into the Gateway

Possible cause: Incorrect credentials

Recommended actions

1. Verify the user name and password (administrator user name is "admin", default password is "default").
2. If unable to connect, consider resetting the Gateway.

6.6 AMS Wireless Configurator: Gateway does not appear in AMS Wireless Configurator

Possible cause: Wireless network interface configuration

Recommended actions

1. Verify the Security Setup Utility is installed on the same PC as AMS Wireless Configurator.
2. Setup a wireless network interface using the Network Configuration application.
3. Verify the wireless network interface is configured for secure Gateway communications.

4. Verify secure/unsecure AMS Wireless Configurator protocol settings in the Gateway.
 - a) Log on to the Gateway.
 - b) Navigate to **SETUP** → **SECURITY** → **PROTOCOLS**.
5. Restart AMS Wireless Configurator data server.
 - a) Right click on **AMS Wireless Configurator** server icon in the Windows system tray (lower right corner).
 - b) Select **Stop server**.

6.7 AMS Wireless Configurator: Wireless devices do not appear under the Gateway

Possible cause: Devices not connected

Recommended actions

1. Log on to the Gateway and navigate to **EXPLORER**.
2. Right click on wireless network and select **Rebuild hierarchy**.

6.8 AMS Wireless Configurator: Wireless device appears with red HART[®] symbol

Possible cause: Non-current device support files

Recommended actions

1. Navigate to Emerson's AMS Device Manager product [page](#).
2. Install latest device support files from AMS Wireless Configurator.

6.9 AMS Wireless Configurator: Device configuration items are grayed out

Possible cause: Session timeout

Recommended actions

1. Verify whether current or historical information is being displayed (setting is displayed at the bottom of each device configuration screen). Configuration requires the **Current** setting.
2. Log back into AMS Wireless Configurator.
For security purposes, a configuration timeout is applied to sessions idle for more than 30 minutes.

6.10 Wireless field devices: Wireless device does not appear on the network

Recommended actions

1. Verify the device has power.
2. Verify the device is within effect communications range.
3. Verify the proper network ID has been entered into the device.

6.11 Wireless field devices: Wireless device appears in the join failure list

Recommended actions

Re-enter the network ID and join key into the device.

6.12 Wireless field devices: Wireless device appears with service denied

Possible cause: Update rate setting

Recommended actions

1. Verify the total number of devices on the network (25 maximum).
2. Go to **SETUP** → **NETWORK** → **BANDWIDTH** and click **Analyze bandwidth**. Any changes will require the network to reform.
3. Reduce the update rate for the device.

6.13 Modbus communications: Cannot communicate using Modbus[®] RTU

Recommended actions

1. Verify the use of RS-485.
2. Verify wiring connections.
3. Verify if termination or a pull up is required.
 - a) Verify that Modbus serial communications settings in the Gateway match the Modbus Host settings.
 - b) Log on to the Gateway and navigate to **SETUP** → **MODBUS** → **COMMUNICATIONS**.
4. Verify the Modbus address for the Gateway.
5. Verify Modbus register mapping in the Gateway.
 - a) Log on to the Gateway and navigate to **SETUP** → **MODBUS** → **MAPPING**.

6.14 Modbus communications: Cannot communicate using Modbus[®] TCP

Possible cause: Incorrect settings

Recommended actions

1. Verify secure/unsecure Modbus protocol settings in the Gateway.
 - a) Log on to the Gateway.
 - b) Navigate to **SETUP** → **SECURITY** → **PROTOCOLS**.
2. Verify the Modbus TCP communications settings in the Gateway.
 - a) Log on to the Gateway.
 - b) Navigate to **SETUP** → **MODBUS** → **COMMUNICATIONS**.
3. Verify Modbus register mapping in the Gateway.
 - a) Log on to the Gateway.
 - b) Navigate to **SETUP** → **MODBUS** → **MAPPING**.

6.15 Modbus communications: Cannot communicate using secure Modbus[®] TCP

Recommended actions

1. Verify the Security Setup Utility has been installed.
2. Configure a secure Modbus proxy for the Gateway (see [Security setup utility](#)).
3. Verify secure/unsecure Modbus protocol settings in the Gateway
 - a) Log on to the Gateway.
 - b) Navigate to **SETUP** → **SECURITY** → **PROTOCOLS**.
4. Verify the Modbus TCP communications settings in the Gateway.
 - a) Log on to the Gateway.
 - b) Navigate to **SETUP** → **MODBUS** → **COMMUNICATIONS**.
5. Verify Modbus register mapping in the Gateway.
 - a) Log on to the Gateway.
 - b) Navigate to **SETUP** → **MODBUS** → **MAPPING**.

6.16 OPC communications: OPC application cannot find a Gateway OPC server

Possible cause: Incorrect Security Setup Utility installation

Recommended actions

1. Verify the Security Setup Utility has been installed on the same PC as the OPC application.
2. Configure an OPC proxy for the Gateway (see [Security setup utility](#)).

6.17 OPC communications: Gateway OPC server does not show any Gateways

Possible cause: Proxy not configured

Recommended actions

Configure an OPC proxy for the Gateway (see [Security setup utility](#)).

6.18 OPC communications: Gateway OPC server does not show any data tags

Possible cause: Configuration or settings

Recommended actions

1. Configure the Gateway OPC Browse Tree.
 - a) Log on to the Gateway.
 - b) Navigate to **SETUP** → **OPC** → **OPC BROWSE TREE**.
2. Verify the connection status for the OPC proxy in the Security Setup Utility.
3. Check to ensure the OPC proxy is configured for secure or unsecure communications.
4. Verify secure/unsecure OPC protocol settings in the Gateway.
 - a) Log on to the Gateway.
 - b) Navigate to **SETUP** → **SECURITY** → **PROTOCOLS**.
5. Verify network firewall and port settings.

6.19 EtherNet/IP™ : Gateway is not publishing the parameters

Possible cause: System integration

Recommended actions

1. Verify connection is established with EtherNet/IP.
 - a) Navigate to **SETUP** → **SECURITY** → **PROTOCOLS**.
2. To connect to an Allen-Bradley® system, reference the Integration [Manual](#).

6.20 Return of materials

To expedite the return process outside of North America, contact your Emerson representative.

Within the United States, call the Emerson Response Center toll-free number 1 800 654 7768. The center, which is available 24 hours a day, will assist you with any needed information or materials.

The center will ask for product model and serial numbers, and will provide a Return Material Authorization (RMA) number. The center will also ask for the process material to which the product was last exposed.

⚠ WARNING

Individuals who handle products exposed to a hazardous substance can avoid injury if they are informed of, and understand, the hazard. If the product being returned was exposed to a hazardous substance as defined by OSHA, a copy of the required Material Safety Data Sheet (MSDS) for each hazardous substance identified must be included with the returned goods.

A Reference data

A.1 Ordering information, specifications, and drawings

To view current Emerson 1410S and 781S ordering information, specifications, and drawings, follow these steps:

Procedure

1. Navigate to the product [page](#) for Emerson 1410S and 781S.
2. Scroll as needed to the green menu bar and click **Documents & Drawings**.
3. For installation drawings, click **Drawings & Schematics** and select the appropriate document.
4. For ordering information, specifications, and dimensional drawings, click **Data Sheets & Bulletins** and select the appropriate Product Data Sheet.

A.2 Product certifications

To view current Emerson 1410S and 781S product certifications, follow these steps:

Procedure

1. Navigate to the product [page](#) for Emerson 1410S and 781S.
2. Scroll as needed to the green menu bar and click **Documents & Drawings**.
3. Click on **Manuals & Guides**.
4. Select the appropriate Quick Start Guide.

B Redundant Gateway systems

B.1 Overview

Redundancy for the Emerson Wireless 1410S Gateway increases the availability of the wireless field network by providing two sets of physical hardware which operate as a single Gateway system. This section covers setup and installation of a redundant Gateway system. It also covers diagnostics and integration to help monitor the health of the redundant Gateway system.

- Where to mount the respective antennas
- Illustration of maximum redundancy including dual switch and UPS
- Understanding how the fail over works and experience to expect
- How to leverage the multimaster capability for Modbus® integrations

B.2 Requirements

Wireless Gateway

- Firmware version 4.3.19 or greater is recommended
- RD option for Gateway redundancy
- Static IP address
- Must have matching output protocols (e.g. Modbus® or OPC®) on each Gateway

Host system

- Ethernet connection for Modbus TCP or OPC DA communications
- Serial (RS-485) connection for Modbus RTU communications

B.3 Setup

When configuring redundant Gateways, it is only necessary to configure one system. The other Gateway will be configured automatically when it is paired with the first Gateway.

Choose one Gateway as the starter Gateway. For the purposes of this document, it will be referred to as Gateway A. The other Gateway will be referred to as Gateway B.

To configure redundancy system settings:

Procedure

1. Connect a PC/laptop to the Ethernet 1 port on Gateway A.
2. Log in using the admin user account.
3. Navigate to **System Settings** → **Gateway** → **Redundancy**.
4. Gateway A factory serial number will be assigned to Gateway A.
5. Gateway B factory serial number will be assigned to Gateway B.

The Gateway names will be used in diagnostic messages and host system integration to help identify each Gateway. Rosemount recommends these names be marked on each physical Gateway, in addition to the configuration settings.

Selecting left or right for Gateway A is for visualization purposes only. It has no effect on performance or functionality.

Figure B-1: System Settings → Gateway → Redundancy

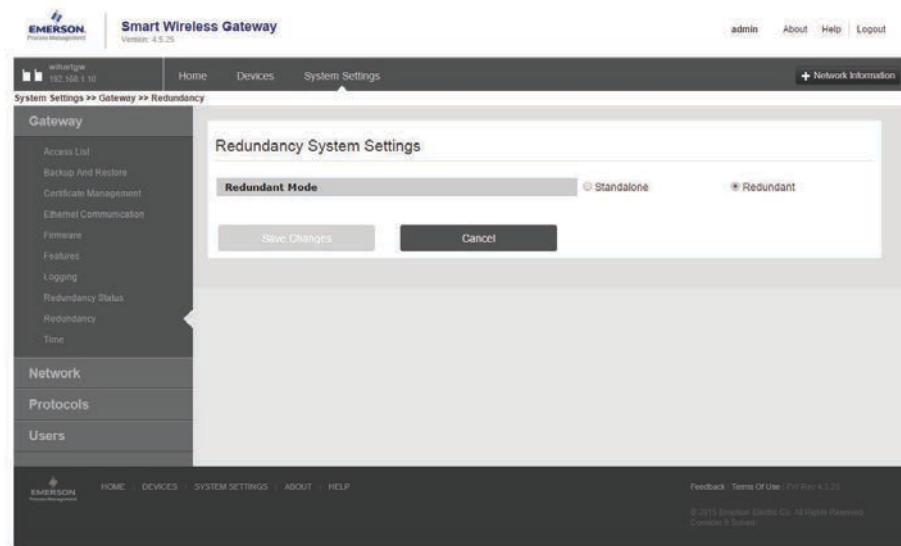

<https://192.168.1.10/brmes/default/Views/index.html#Settings/gateway/redundancy>

B.3.1 Connect Gateways

After the redundancy system settings have been configured, the two Gateways must be connected and undergo a pairing process. To pair both Gateways and form a redundant system:

Procedure

1. Connect a PC/laptop to the primary Ethernet port on Gateway A.
2. Log in using the admin user account.
3. Navigate to **System Settings** → **Gateway** → **Redundancy Status**.
4. Connect the secondary Ethernet port on Gateway A to the secondary Ethernet port on Gateway B (see [Figure B-2](#)).
5. After a few minutes, a dialog will appear on the page; select **Form redundant pair**.
6. Wait for the **Pairing to redundant peer** status to turn green.

B.3.2 Paired Gateways

Once the Gateways have finished the pairing process, Gateway A will appear as the current active Gateway on the left hand side and Gateway B will be the standby Gateway on the right. If significant configuration changes need to be downloaded to the standby Gateway, it may temporarily go offline shortly after the pair process is complete. This is expected behavior and does not represent instability in the system.

Figure B-2: Redundant Pair

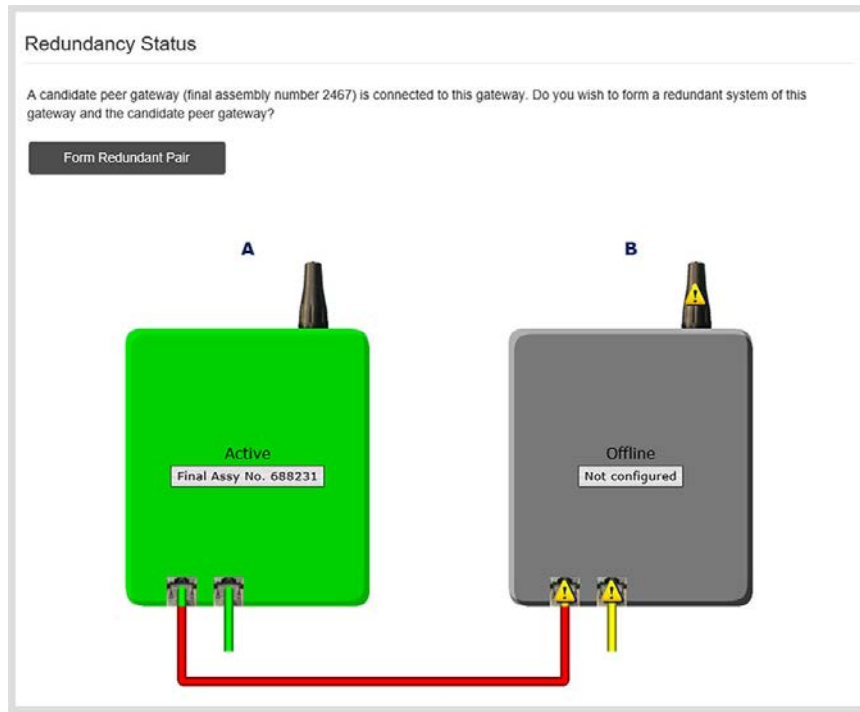

Figure B-3: Pairing Gateways

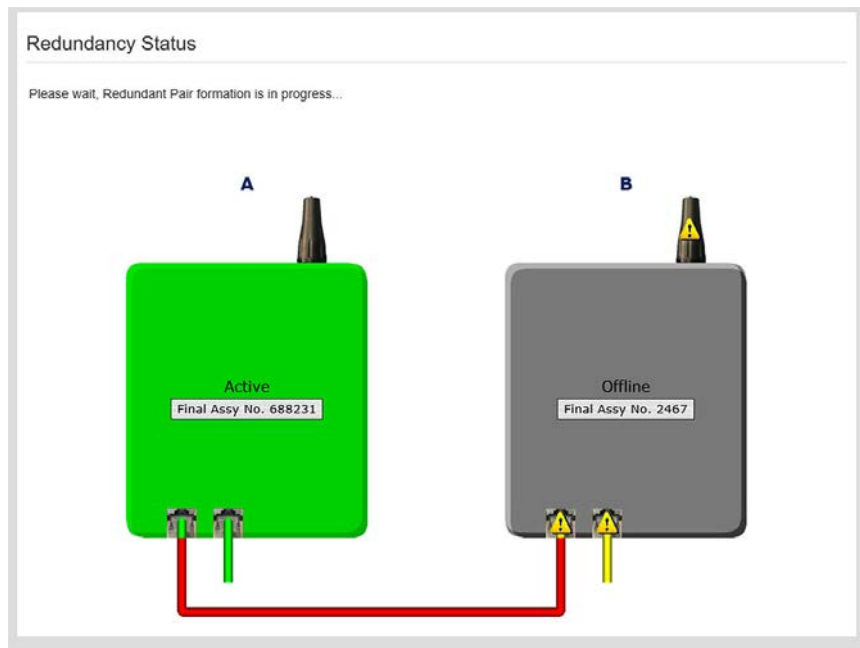
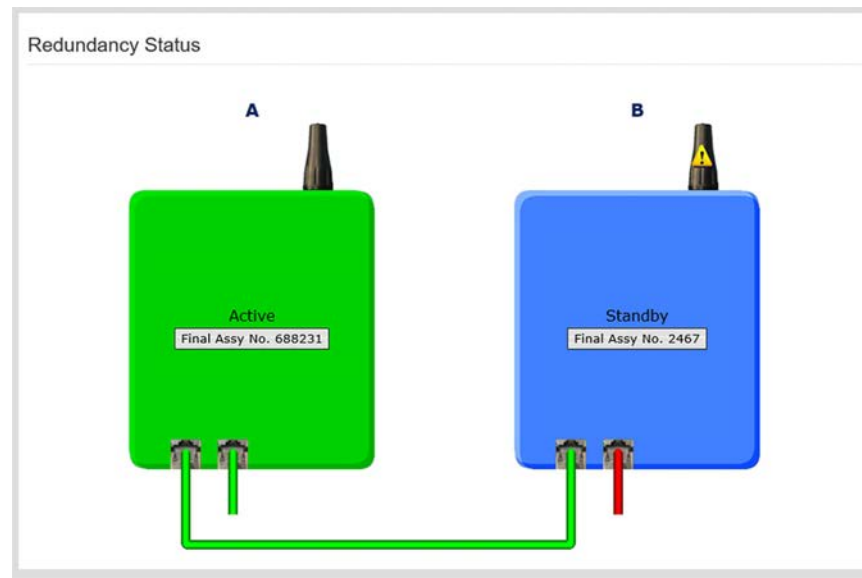

Figure B-4: Paired Gateways



B.3.3 Mounting and connections

Redundant Gateways follow similar mounting and connection practices as a standalone Gateway. Refer to [Mounting the Emerson 1410S2 Gateway](#) for more information. In addition to the standard practices, apply the the following considerations when installing redundant Gateways.

Mounting

Mount the Emerson 1410S Gateway in a location allowing convenient access to the process control network while providing good coverage for the wireless field network.

Mount the two Emerson 781S Smart Antennas at the same height and ensure they are spaced between 3–9 ft. (1–3 m) horizontally. This spacing ensures they provide identical coverage for the wireless field network and to help eliminate a coverage gap in the event of a switch over.

Ethernet

An Ethernet connection to the host system will support Modbus[®] TCP, OPC, AMS Wireless Configurator, and HART-IP[™] protocols. When using this architecture, connect the secondary Ethernet port on Gateway A directly to the secondary Ethernet port on Gateway B. Then connect the primary Ethernet ports for both Gateways to a process control network using separate/redundant network switches. See [Figure B-5](#).

Figure B-5: Ethernet Connection Architecture

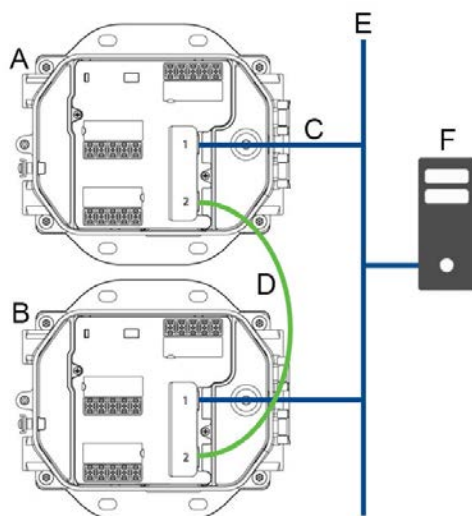

- A. Gateway A
- B. Gateway B
- C. Primary Ethernet
- D. Secondary Ethernet
- E. Process control network
- F. Engineering station

Note

Connect the primary Ethernet port for each network to separate network switches on the same process control network. Consult a control system administrator for more details about available redundant network switches.

Power

Apply power for the redundant Gateways after all primary and secondary Ethernet and RS-485 connections have been made. Using separate uninterruptible power supplies (UPS) is recommended to ensure availability of the redundant Gateway system.

B.4 Diagnostics

The redundant system will perform many diagnostic checks to verify the health and connectivity of the system. In the event of a failure, it can take up to 30 seconds for the Gateway to trade positions.

These diagnostics can also be mapped to Modbus® registers or OPC tags. The following table covers what diagnostics are included on the **Redundancy Status** page as well as how they can be mapped as parameters in Modbus or OPC.

Table B-1: Redundancy Diagnostics

Parameter	Description	Data type
REDUNDANT_HEALTHY	Overall redundancy status indicating the system is ready for a switch-over	Boolean

Table B-1: Redundancy Diagnostics (continued)

Parameter	Description	Data type
RF_COVERAGE_FAILURE	Check to verify that both Gateways have the same RF coverage of the wireless field network	
REDUNDANT_A_ONLINE	Operational status of Gateway A	
REDUNDANT_A_MASTER	Indication if Gateway A is the active system	
REDUNDANT_A_PING	Indication if Gateway A is able to ping designated host IP address	
REDUNDANT_A_ETH0	Electrical connection status of the primary Ethernet port for Gateway A	8-bit unsigned int
REDUNDANT_B_ONLINE	Operational status of Gateway B	Boolean
REDUNDANT_B_MASTER	Indication if Gateway B is the active system	
REDUNDANT_B_PING	Indication if Gateway B is able to ping designated host IP address	
REDUNDANT_B_ETH0	Electrical connection status of the primary Ethernet port for Gateway A	8-bit unsigned int

In addition to the redundancy diagnostics, an additional check may be configured to test network connectivity to a host system or other application. The redundant system will use this check to determine the best connectivity option and which Gateway should be set to the active Gateway.

To configure network connectivity check:

1. Navigate to **System Settings** → **Gateway** → **Ethernet Communication**.
2. Enter the host system IP address in the **Check Network Connectivity IP Address** field.
3. Select **Save Changes**.

Figure B-6: Network Connectivity Check

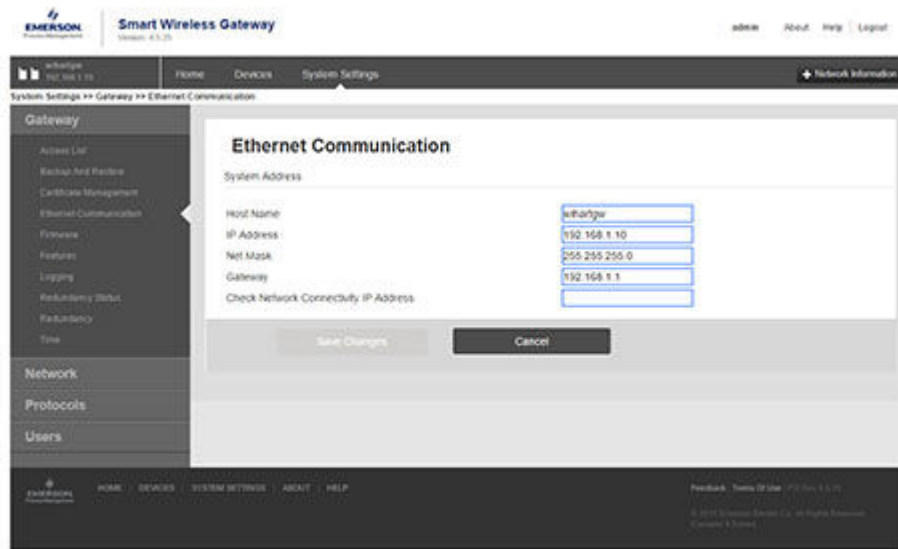

<https://192.168.1.10/Menu/default/View/Info/MenuPath/gateway/ethernet>

B.5 Gateway replacement

When replacing or reintroducing a Gateway in a redundant system, always connect both the primary and secondary Ethernet connections before powering the standby Gateway. If the Gateway is being reintroduced (i.e. it was a part of the original redundant system), it will automatically rejoin the redundant system.

If the Gateway is new or has been set to default configuration, it will need to be paired to the current active Gateway. Navigate to **System Settings** → **Gateway** → **Redundancy** and follow the recommended actions on that page or follow [Connect Gateways](#) to pair Gateways and form a redundant system.

C Dual mode (*WirelessHart*[®] and IEC 62734) network specifications

C.1 Dual mode upgrades

The Emerson Wireless 1410S Gateway has the ability to connect two Emerson 781S Smart Antennas. This upgrade can be added upon purchase of the Gateway, or it can be added later through an order option file. This option file can be downloaded through the Gateway web interface. There are no hardware variances between the standard Gateway and a dual mode besides the addition of another Emerson 781S Smart Antenna. Dual mode capabilities are not possible if the Gateway has integrated intrinsically safe barriers. These barriers are intended for Emerson 781S Smart Antenna installation in Class 1 Div 1 or Zone 0 areas. If dual mode and this installation are required, purchasing separate intrinsically safe barriers to use with the dual mode Gateway is recommended.

C.2 IEC 62734 Network

The Emerson 1410S Gateway supports communications to the Emerson 781SC Smart Antenna that communicates through the IEC 62734 standard (ISA100 protocol). This protocol is intended for legacy devices to be supported while a transition to *WirelessHART*[®] is made.

Figure C-1: Network Settings

The screenshot displays a web form for configuring ISA network settings. It includes the following elements:

- ISA Network name:** A text input field containing the value "ISAsystemdual".
- ISA Network ID:** A text input field containing the value "1776".
- ISA Join Key:** Four masked input fields, each containing seven dots (•••••••).
- Show ISA join key:** A checkbox that is currently unchecked.
- Buttons:** "Save Changes" and "Cancel" buttons located at the bottom of the form.

This network is separate from the *WirelessHART* network. The network settings can be changed on the **System Settings** → **Network** → **Network Settings** page below the *WirelessHART* settings. Chose a unique network name for both the *WirelessHART* and ISA100 networks. These settings are separate and need to be saved one at a time for changes to take effect.

C.3 IEC 62734 Device support

Since these devices communicate through a different network, they will appear separate from *WirelessHART*® devices in the Gateway user interface, but still all at the same IP address and web page. These devices will appear in two separate tables in the **Gateway Devices** page.

Figure C-2: Devices Page

The screenshot shows the 'Wireless Gateway' interface with the 'Devices' tab selected. At the top, there are status indicators: 'All Devices 10', 'Live 6', 'Unreachable 4', and 'Power Module Low 0'. Below these are two tables of device data.

WirelessHART Devices					
Name	PV	SV	TV	QV	Last Update
--- NO TAG --- (00-1B-1E-26-66-0F-95-D5)	23.75 DegC	1.493 %	3.231 %	NaN	05/04/20 16:33:55
--- UNKNOWN --- (00-1B-1E-26-63-0F-42-9A)					
1410S-Chris	4	2	65.5 DegC	NaN	05/04/20 16:33:55
1717 WPG	0.035 PSI	22.815 DegC	0.035 PSI	3.549 V	05/04/20 12:42:37
435B_new	-0.079 InH2O 60F				05/04/20 16:33:54

ISA100 Devices					
Name	CH01	CH02	CH03	CH04	Last Update
Davy Jones	10.464 Manufacturer Specific	26.059 degree Celsius	0 degree Celsius	0 percent	02/26/20 13:47:40
Flying Dutchman	11.608 Manufacturer Specific	25.469 degree Celsius	0 degree Celsius	0 percent	02/26/20 13:47:55
Nina	NaN	NaN			
Pinta	22.846 degree Celsius	22.841 percent			05/04/20 16:33:25

On this page, you can see the two device tables for both your *WirelessHART* devices and legacy ISA100 devices. The ISA100 device table shows channels (1-4) instead of variables as this is how these devices are set up to publish data. Other than this, the tables are set up very similarly and can be navigated the same way.

Devices can be selected and expanding to show detailed device information. Although the detailed information isn't as extensive as what you would see from a *WirelessHART* device, more information can still be found on this page. The devices role is a key piece of information found here. Since ISA100 doesn't have native mesh abilities like a *WirelessHART* device does, this can show you whether or not the device is able to route information through it's neighboring devices. If a device is considered a "router device" then it is communicating through it's neighbors like a *WirelessHART* device. All published data from the device can also be viewed through this page.

Figure C-3: Detailed Device Information Page

BBDE		28.751 degree Celsius		04/20/20 11:25:25
Detailed Device Information				
ISA100 Details				
ISA100 Status				
<input checked="" type="checkbox"/> More status available Loop current saturated				
Tag Name	Device Id	Channel 1 Units	Burst Rate	
BBDE	30	degree Celsius	60.0	
Power Supply Status		Device Role		
Line Powered		IO Router Device		
Network				
Last Join		Total Joins		
03/31/20 14:05:04		1		
Data Reliability %	RSSI dB	RSQI		
100	-25	255		
View All Published Data				
Presence	Delete			

D DeltaV™ ready

D.1 Overview

Native integration with DeltaV™ enables the Emerson™ Wireless 1410s Gateway (Gateway) to be autosensed and easily commissioned for seamless integration with all DeltaV applications: Explorer, Diagnostics, and Control Studio. *WirelessHART*® devices can be easily added to the wireless field network and then reconciled through DeltaV Explorer and assigned to analog channels through drag and drop assignment.

D.2 Latency considerations in control logic design and operation

Since the DeltaV™ wireless I/O scanner software requests updates for of the devices each second, DeltaV receives updates on a particular field device once every five seconds. The field device updates are not necessarily synchronized with the update rate of the field device. Also, there is some latency between when the field device takes a process sample and when it is permitted to pass its value onto the wireless network. Status update responses can also increase latency in some instances. For example, if a device updates once every eight seconds, and wireless network latency is two seconds, the amount of time between when an event occurred in the field and before it is available to the DeltaV I/O bus is between zero and 15 (8+2+5) seconds. The update period of the DeltaV control module should be added to that total to determine the range of latencies before an event in the field can be acted upon by the control system.

Advise operators that the update rate of wireless measurements on operator screens are somewhat slower than those from wired devices. For example, if the operator initiates a valve movement, it can be five to 15 seconds before confirming feedback appears on the operator screen. Any control logic designed along the same principles should also take the update rates and latencies into account as well.

D.3 Requirements

DeltaV™

Version 10.3 or newer.

Gateway

DeltaV Ready option (Data Protocol option 5). Refer to the Ordering information available in the [Emerson Wireless 1410S Gateway with 781S Smart Antenna Product Data Sheet](#).

D.4 Mounting the Gateway

Mount the DeltaV™ Ready Gateway in the same manner as a standard Gateway.

Prerequisites

Mount the Gateway in a location allowing convenient access to the DeltaV control network as well as the wireless field network.

Procedure

1. Connect the Gateway's primary Ethernet port (Ethernet 1) into the DeltaV primary control network.
2. If the dual Ethernet option (Physical Connection code 2) was ordered with the Gateway, connect the secondary Ethernet port (Ethernet 2) into the DeltaV secondary control network.

Figure D-1: Delta V Control Network Architecture

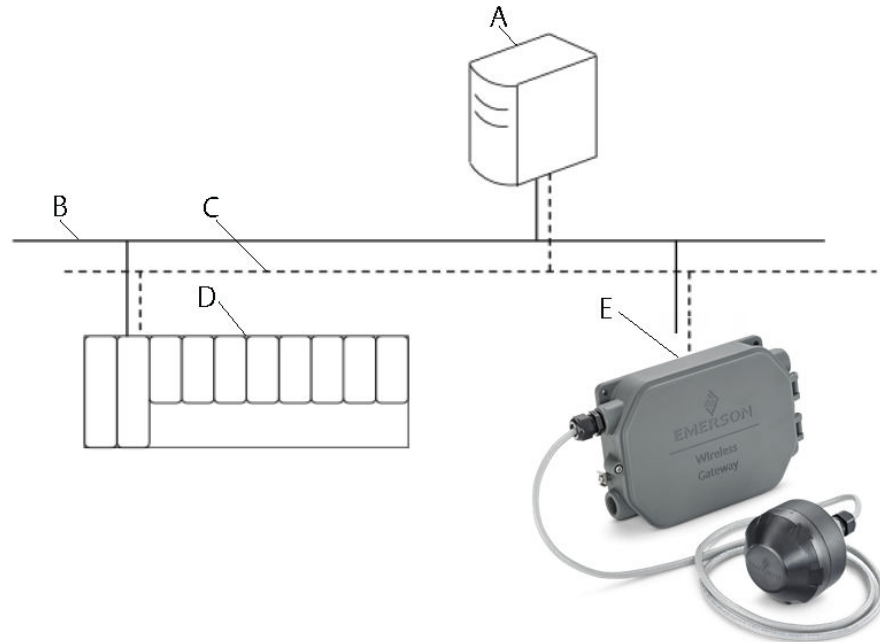

- A. Pro + Engineering Station
- B. Primary Control Network
- C. Secondary Control Network
- D. Controller and I/O
- E. Gateway

D.5 Setup

Out of the box the Gateway is pre-configured for use on the DeltaV™ control network. In the DeltaV Explore application, the Gateway will automatically appear in the Decommissioned Nodes folder.

D.5.1 Setup a wireless network

Procedure

1. Commission the Gateway.
2. Assign wireless device tags.
3. Assign the Gateway to the controller and download.

Figure D-2: Decommissioned Notes Folder within DeltaV Explorer

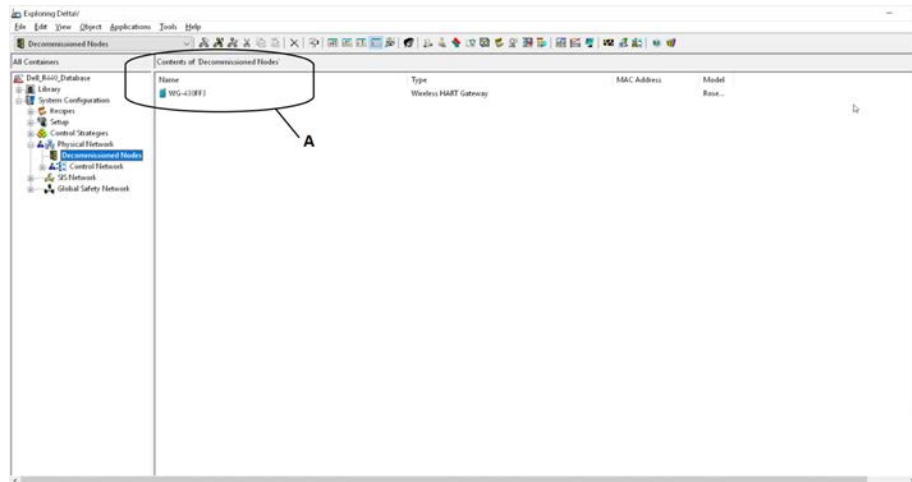

A. New Wireless Gateway

D.5.2 Commission the gateway

Procedure

1. Navigate to **START** → **PROGRAMS** → **DELTA V** → **ENGINEERING** → **DELTA V EXPLORE** to launch the DeltaV™ Explorer application.
2. Expand the folder **SYSTEM CONFIGURATION** → **PHYSICAL NETWORK** → **DECOMMISSIONED NODES**.
3. Select the Gateway in the Decommissioned Node and drag it onto the Wireless I/O Network.
4. Enter a name for the Gateway and select **OK**.
5. Select **YES** when prompted to Auto-Sense Wireless Gateway.
The Reconcile I/O window will appear. The purpose of this screen is to assign *WirelessHART*® devices to the DeltaV I/O channel. This allows the wireless device to be referenced in other DeltaV applications, like Control Studio.

D.5.3 Assign wireless device tags

Procedure

1. Drag and drop *WirelessHART*® device from the Unassigned Wireless HART Devices: list to the Channels list.
2. Repeat this process for each wireless device until all have been assigned.
3. Select **OK** to continue.

D.5.4 Assign the gateway to a DeltaV™ controller

Procedure

1. Right click on the Gateway and select **Assign...**
2. Use the browse window and select the desired controller.

3. Select **OK** to close the assignment window.
4. Follow the download dialog.
5. Select **OK** to close the download window.

Figure D-3: Gateway Conext Menu (Right Click)



Now the Gateway and wireless devices are fully commissioned and available to use in other DeltaV applications. When new devices are added to the wireless network, they will need to be assigned to DeltaV channels through the reconcile process (right click on Gateway and select configure IO).

Note

Logging in to the Gateway is not possible using the default TCP/IP network setting. If the Gateway is decommissioned, use an IP address 10.5.255.254. If the Gateway is commissioned, right click on the Gateway in DeltaV Explore and select Wireless Gateway Web Interface.

E Dual *WirelessHART*[®] Feature Guide

Dual *WirelessHART*[®] is a feature on the 1410S that allows two *WirelessHART* 781S Smart Antennas to connect to a single 1410S. This section outlines compatibility of existing hardware with two 781S Smart Antennas and how to use a 1410S Gateways with the Dual *WirelessHART* feature.

With Dual *WirelessHART*-enabled on a 1410S Gateway, up to 400 devices can connect to a single 1410S Gateway running independent networks for each 781S Smart Antenna.

Before considering upgrading your existing 1410S Gateway, [Hardware compatibility for Dual *WirelessHART*[®]](#) below provides hardware compatibility details when connecting two *WirelessHART* 781S Smart Antennas to a single 1410S Gateway.

E.1 Hardware compatibility for Dual *WirelessHART*[®]

1410S1 DIN-rail mounted gateway

All 1410S1 Gateways can have two 781S Smart Antennas connected and be field upgraded with Dual *WirelessHART* feature.

For 1410S1 Gateways specified with Intrinsically Safe Outputs Option (A), the 781S Smart Antennas must be hardware revision 2.0.0. The hardware revision of the 781S can be found on the physical label.

1410S2 outdoor enclosure gateway

All 1410S2 Gateways with Intrinsically Safe Outputs Options (B) or (N) can have two 781S Smart Antennas connected and be field upgraded with Dual *WirelessHART* feature.

When a 1410S2 is specified with Intrinsically Safe Outputs Option (A), there is a limitation of connecting two 781S Antennas. This (A) option provides outputs to the 781S Smart Antenna compatible for installation of the 781S in a Zone 0 or Class 1 Div 1 area.

On 1410S2 Gateways with hardware revision 1.0.0 and the Intrinsically Safe Outputs Option (A) option specified, only one 781S can be connected to the Gateway. Hardware revision 1.0.0 1410S2 Gateways cannot be field upgraded with Dual *WirelessHART* feature. Dual *WirelessHART* networks running on a single 1410S2 Gateway with the (A) option selected requires hardware revision 2.0.0 or later of the 1410S2 Gateway. 1410S2 hardware revision 2.0.0 is currently in progress. The hardware revision of the 1410S2 Gateway can be found on the physical label.

Legacy gateways (1420/1410B/1410D)

Dual *WirelessHART* is only available on 1410S Gateways.

E.2 Upgrading a 1410S Gateway with Dual *WirelessHART*[®]

To upgrade an existing 1410S Gateway with the new Dual *WirelessHART*[®] feature, the Gateway must be running Version 6.7.5 firmware or later. An option file enables the feature on the Gateway which must be purchased from the factory. Please reach out to your local Emerson representative for purchasing your option file.

Gateway firmware upgrades are available free of charge on our [Emerson Wireless Gateway Firmware Download Request](#) web page.

Once the option file is received and the Gateway has been upgraded to Version 6.7.5 or later, navigate to the Features page of the Gateway web interface as shown in [Figure E-1](#).

Figure E-1: Features Page of Gateway Web Interface

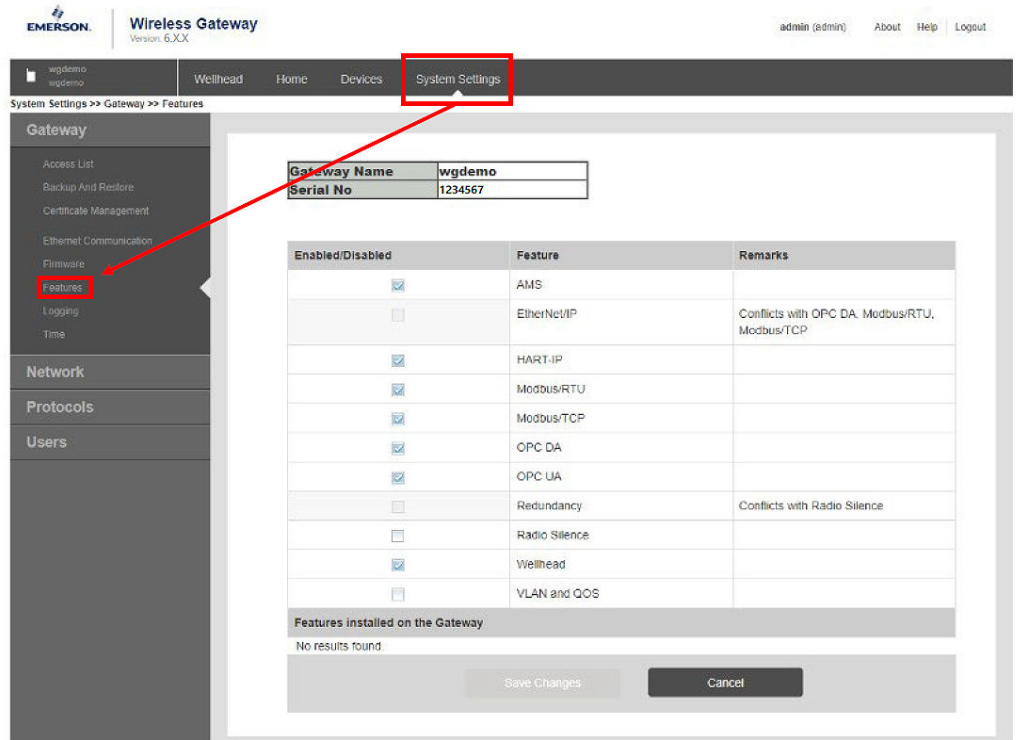

From the Features page, the **Upgrade Current Features** field allows uploading of the option file to enable Dual *Wireless*HART on the 1410S (see [Figure E-2](#)). Upload the option file and click install to begin the installation.

⚠ WARNING

Upgrading the Gateway features requires a restart of the Gateway which will cause the wireless network to restart and need to reform. This can take some time depending on the network.

If momentary loss of data from your network cannot be tolerated, please schedule this installation at a time that can tolerate a network restart.

Figure E-2: Upgrade Current Features Field for Installing an Option File

The screenshot displays the Emerson Wireless Gateway web interface. At the top, the header includes the Emerson logo, 'Wireless Gateway Version: 6.X.X', and user information 'admin (admin) About Help Logout'. The navigation bar shows 'wgdemo wgdemo' and menu items 'Wellhead Home Devices System Settings'. The main content area is titled 'System Settings >> Gateway >> Features'. On the left, a sidebar menu lists 'Gateway', 'Network', 'Protocols', and 'Users'. The 'Gateway' section is active, showing a table with gateway details: Gateway Name 'wgdemo' and Serial No '1234567'. Below this is a table of features with columns 'Enabled/Disabled', 'Feature', and 'Remarks'. Features include AMS, EtherNet/IP, HART-IP, Modbus/RTU, Modbus/TCP, OPC DA, OPC UA, Redundancy, Radio Silence, Wellhead, and VLAN and QOS. A section titled 'Features installed on the Gateway' shows 'No results found.' At the bottom of this section are 'Save Changes' and 'Cancel' buttons. A red box highlights a separate section titled 'Upgrade Current Features' which contains the text 'Select an option file', a 'Browse' button next to an empty text input field, and an 'Install' button at the bottom.

Enabled/Disabled	Feature	Remarks
<input checked="" type="checkbox"/>	AMS	
<input type="checkbox"/>	EtherNet/IP	Conflicts with OPC DA, Modbus/RTU, Modbus/TCP
<input checked="" type="checkbox"/>	HART-IP	
<input checked="" type="checkbox"/>	Modbus/RTU	
<input checked="" type="checkbox"/>	Modbus/TCP	
<input checked="" type="checkbox"/>	OPC DA	
<input checked="" type="checkbox"/>	OPC UA	
<input type="checkbox"/>	Redundancy	Conflicts with Radio Silence
<input type="checkbox"/>	Radio Silence	
<input checked="" type="checkbox"/>	Wellhead	
<input type="checkbox"/>	VLAN and QOS	

Upgrade Current Features

Select an option file

Browse

Install

E.3 Dual *WirelessHART*® Operation Guide

Once the Gateway has come back online, the home page will now show *WirelessHART* Gateway Load and *WirelessHART* Network Best Practices for both networks.

Figure E-3: Home Page Showing Dual *WirelessHART*®

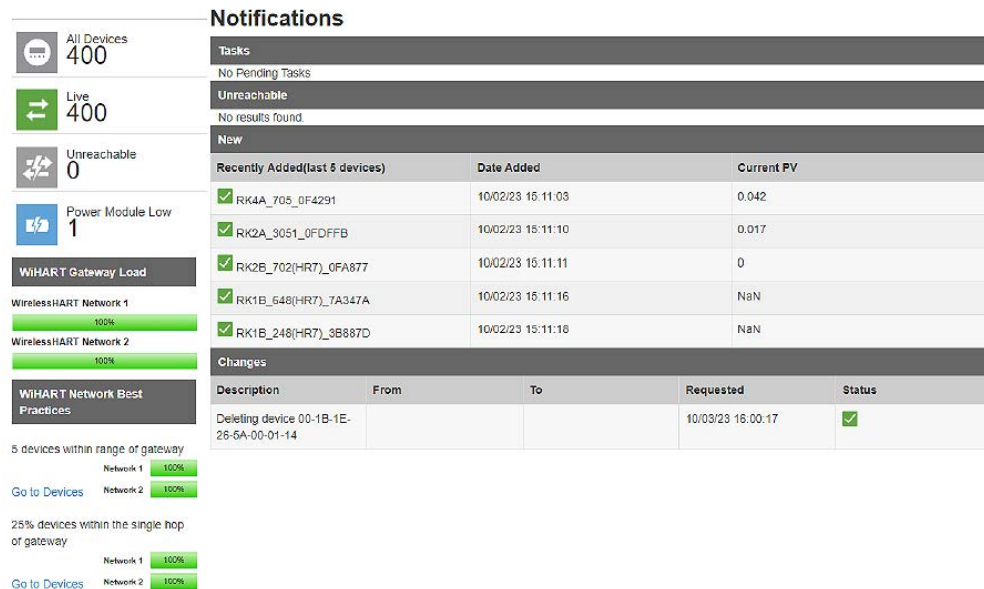

Devices page

The Devices page will show all devices among both networks. A drop-down menu can be used to filter which network devices are displayed. On the left side of the table, each device's network is shown as shown in the following figure.

Figure E-4: Device Pages Showing All Network Devices

October 2023

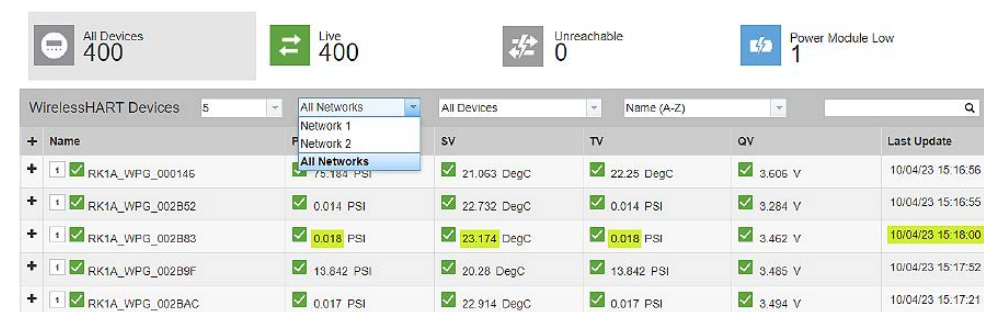

Device tags must be unique between the two networks. The Gateway web interface will prompt if there are duplicate tags as shown in Figure E-5. When two devices have the same tag name, variable mapping can be unclear on which device is being mapped.

Figure E-5: Duplicate Device Name Prompt

The screenshot shows a dashboard with four status indicators: All Devices (400), Live (400), Unreachable (0), and Power Module Low (1). Below these is a table of WirelessHART Devices with columns for Name, PV, SV, TV, QV, and Last Update. Two rows for '708 Office' are highlighted in red, with a red 'Duplicate device name' warning icon and text next to each. The second '708 Office' row has a yellow highlight on its 'Last Update' field.

Name	PV	SV	TV	QV	Last Update
✓ RK1A_WPG_000146	✓ 75.184 PSI	✓ 21.063 DegC	✓ 22.25 DegC	✓ 3.608 V	10/04/23 15:16:56
✓ 708 Office ⚠ Duplicate device name	✓ 0 counts	✓ 21.164 DegC	✓ 22 DegC	✓ 3.648 V	07/25/23 14:47:14
✓ 708 Office ⚠ Duplicate device name	✓ 0 counts	✓ 22.51 DegC	✓ 22.5 DegC	✓ 3.653 V	07/25/23 14:47:17
✓ RK1A_WPG_002BAC	✓ 0.017 PSI	✓ 22.914 DegC	✓ 0.017 PSI	✓ 3.494 V	10/04/23 15:17:21

Network settings configuration

Navigate to System Settings for configuring both Network 1 and Network 2 settings. Each network requires a unique Network ID. The Gateway web interface will alert if the two networks have the same Network ID and will not save the configuration if the Network ID is not unique.

Figure E-6: Network Settings Page for Network 1. Similar page can be found on Network 2

The screenshot shows the 'System Settings >> Network 1' page. A left sidebar contains a menu with 'Gateway', 'Network 1', 'Network 2', 'Protocols', and 'Users'. The 'Network 1' menu item is selected. The main content area is titled 'Network 1' and contains five settings sections:

- Channels**: Control the radio frequencies that WirelessHART network uses.
- Network Settings**: Configure the WirelessHART network settings. This include the network name, network ID and join key.
- Access Control List**: Configure individual join keys for each device.
- Network Statistics**: Display the current wireless network statistics.
- Radio Silence**: Configure radio silence device.

Protocols and ports configuration

Dual *WirelessHART* provides two *WirelessHART* networks under one IP address for HART-IP based protocols. Connecting to client systems or central hosts via HART-IP requires the ability for connecting to two separate ports on a single IP address. Each network's port number can be assigned in the Protocols and Ports page. The protocols that require unique port number assignments for each network will have a "1" or "2" for Network 1 or Network 2, respectively, in the **Ports and Protocols** settings page.

Connecting a Dual *WirelessHART* Gateway via HART-IP with a client system or central host without capability for two separate ports on a single IP address can be done by using the two Ethernet ports and assigning Network 1 to one Ethernet port and Network 2 to the other Ethernet port. In this configuration, both networks have unique IP addresses and port number assignments.

For all other Ethernet communication protocols (e.g., Modbus TCP, Ethernet-IP, OPC-UA), both Network's data will be communicated through a single port.

Figure E-7: Protocols and Ports Page with Dual *WirelessHART* Enabled

System Settings >> Protocols >> Protocols And Ports

Protocols And Ports				
Enabled	Protocol	Port Type	Port	Port Upper Range [UDP]
<input checked="" type="checkbox"/>	AMS 1	TCP	33333	
<input checked="" type="checkbox"/>	AMS 2	TCP	44444	
<input type="checkbox"/>	AMS Secure 1	TCP	32000	
<input type="checkbox"/>	AMS Secure 2	TCP	32001	
<input checked="" type="checkbox"/>	DHCP	UDP	68	
<input checked="" type="checkbox"/>	HART-IP Secure 1	TCP	5095	
<input checked="" type="checkbox"/>	HART-IP Secure 2	TCP	6095	
<input checked="" type="checkbox"/>	HART-IP TCP 1	TCP	5094	
<input checked="" type="checkbox"/>	HART-IP TCP 2	TCP	6094	
<input type="checkbox"/>	HART-IP UDP 1	UDP	5094	5110
<input type="checkbox"/>	HART-IP UDP 2	UDP	6094	6110
<input checked="" type="checkbox"/>	HTTP	TCP	80	
<input checked="" type="checkbox"/>	HTTPS	TCP	443	
<input checked="" type="checkbox"/>	Modbus TCP	TCP	502	
<input checked="" type="checkbox"/>	Modbus TCP Secure	TCP	1502	
<input type="checkbox"/>	NTP	UDP	123	
<input checked="" type="checkbox"/>	OPC UA	TCP	4840	
<input checked="" type="checkbox"/>	OPC UA Secured	TCP	4848	
<input checked="" type="checkbox"/>	Ping			

1 - 19 of 19 results

Dual WirelessHART Gateway name set up

Under **System Settings** → **Protocols** → **HART**, the Gateway name can be configured for both Network 1 and Network 2.

If **Use ethernet protocol hostname for Gateway name** is checked, the Gateway will default Gateway name for Network 1 as the ethernet protocol hostname and adds a "1" to the end of the ethernet protocol hostname for Network 2.

See the following figure for how the settings page and the ethernet protocol hostname box checked.

Figure E-8: Gateway Name Set-Up Page

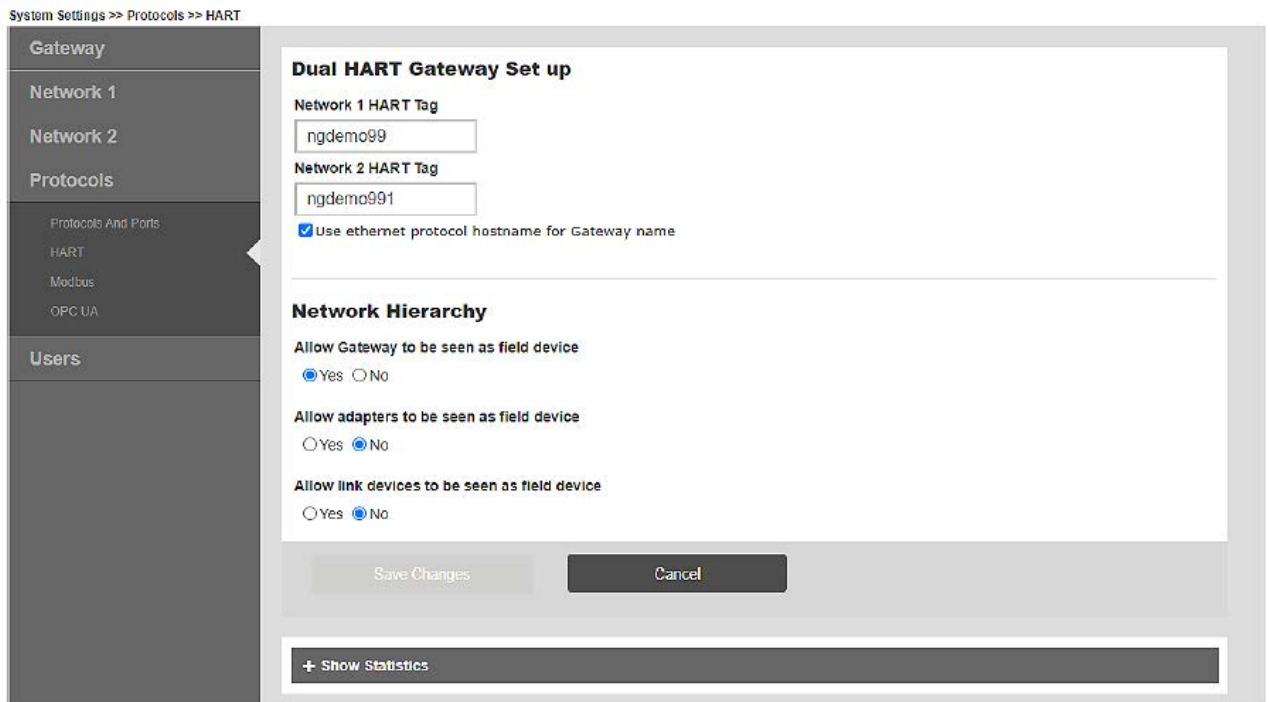

For more information: [Emerson.com/global](https://emerson.com/global)

©2023 Emerson. All rights reserved.

Emerson Terms and Conditions of Sale are available upon request. The Emerson logo is a trademark and service mark of Emerson Electric Co. Rosemount is a mark of one of the Emerson family of companies. All other marks are the property of their respective owners.

ROSEMOUNT™

