

Site Considerations for Equipment Installation, Grounding, and Wiring Manual



FB3000 Remote Terminal Unit (RTU)



FB1100/1200 Flow Computer



FB2100/2200 Flow Computer



ROC800, FloBoss™ 107, ControlWave™ Family of Flow Computers and RTUs

Application & Device Safety Considerations

▪ **Reading these Instructions**

Before operating a device or application, read these instructions carefully and understand their safety implications. In some situations, improper use may result in damage or injury. Keep this manual in a convenient location for future reference. Note that these instructions may not cover all details or variations in equipment or cover every possible situation regarding installation, operation, or maintenance. Should problems arise that are not covered sufficiently in the text, immediately contact Energy and Transportation Solutions (ETS) Customer Support for further information.

▪ **Protecting Operating Processes**

The failure of a device or application – for whatever reason – may leave an operating process without appropriate protection and could result in possible damage to property or injury to persons. To protect against this, review the need for additional backup equipment or provide alternate means of protection (such as alarm devices, output limiting, fail-safe valves, relief valves, emergency shutoffs, emergency switches, etc.). Contact ETS for additional information.

▪ **Using Qualified Personnel**

Installation, configuration, and any subsequent modifications to a device or application should only be performed by qualified, suitably trained personnel information.

▪ **System Training**

A well-trained workforce is critical to the success of your operation. Knowing how to correctly install, configure, program, calibrate, and troubleshoot your Emerson equipment provides your engineers and technicians with the skills and confidence to optimize your investment. ETS offers a variety of ways for your personnel to acquire essential system expertise. Our full-time professional instructors can conduct classroom training at several of our corporate offices, at your site, or even at your regional Emerson office. You can also receive the same quality training via our live, interactive Emerson Virtual Classroom and save on travel costs. For our complete schedule and further information, contact the ETS Training Department at 800-338-8158 or email us at education@emerson.com.

▪ **Grounding Equipment**

Ground metal enclosures and exposed metal parts of electrical instruments in accordance with relevant safety standards. For the USA, refer to OSHA rules and regulations as specified in *Design Safety Standards for Electrical Systems*, 29 CFR, Part 1910, Subpart S, dated: May 16, 1981 (OSHA rulings are in agreement with the National Electrical Code). For international locations, refer to IEC 60364-4-41: PROTECTION AGAINST ELECTRIC SHOCK. You must also ground mechanical or pneumatic instruments that include electrically operated devices such as lights, switches, relays, alarms, or chart drives. The chassis (or earth ground) lug provides a safe connection point to a customer-designated ground location for ESD and transient voltage suppression. Do not use the chassis ground lug for signal, common, or return connections. **Do not connect the chassis ground lug directly to a lightning arrester/lightning rod.** Do not run signal wiring in conduit or open trays with power wiring or near heavy electrical equipment. If shielded wiring is used, ground the shield of the signal wiring at any one point of the signal loop.

Important: Complying with the codes and regulations of authorities having jurisdiction is essential to ensuring personnel safety. The guidelines and recommendations in this manual are intended to meet or exceed applicable codes and regulations. If differences occur between this manual and the codes and regulations of authorities having jurisdiction, those codes and regulations must take precedence.

▪ **Protecting from Electrostatic Discharge (ESD)**

Any device contains sensitive electronic components which can be damaged by exposure to an ESD voltage. Depending on the magnitude and duration of the ESD, it can result in erratic operation or complete failure of the equipment. Ensure that you correctly care for and handle ESD-sensitive components.

▪ **Ethernet Connectivity**

This automation device is intended to be used in an Ethernet network which **does not** have public access. The inclusion of this device in a publicly accessible Ethernet-based network is **not recommended**.

▪ **Returning Equipment**

If you need to return any equipment to ETS, it is your responsibility to ensure that the equipment has been cleaned to safe levels, as defined and/or determined by applicable federal, state and/or local law regulations or codes. You also agree to indemnify ETS and hold ETS harmless from any liability or damage which ETS may incur or suffer due to your failure to ensure device cleanliness.

Contents

Chapter 1: Overview	1
1.1 Safety Labels	1
1.2 Organization	2
Chapter 2: Protection	5
2.1 Protecting Equipment Systems	5
2.1.1 Quality is Conformance to Requirements	5
2.2 Protecting Equipment and Personnel	6
2.2.1 Considerations for Protecting Personnel	6
2.2.2 Considerations for Protecting Equipment	7
2.3 Other Site Safety Considerations	8
Chapter 3: Earthing and Isolation	11
3.1 Power and Ground Systems	11
3.2 Importance of Good Grounds	11
3.3 Earth Ground Connections	12
3.3.1 Establishing a Good Earth Ground	12
3.3.2 Ground Wire Considerations	17
3.3.3 Other Grounding Considerations	18
3.4 Isolating Equipment from the Pipeline	19
3.4.1 Meter Runs without Cathodic Protection	19
3.4.2 Meter Runs with Cathodic Protection	20
Chapter 4: Lightning Arresters and Surge Protectors	23
4.1 Strike	23
4.1.1 Chance of Being Struck by Lightning	23
4.1.2 Antenna Caution	26
4.1.3 Ground Propagation	29
4.1.4 Tying it all Together	29
4.1.5 Impulse Protection Summary	30
4.2 Use of Lightning Arresters and Surge Protectors	30
4.2.1 Installing Lightning Arresters and Surge Protectors	31
Chapter 5: Wiring Techniques	33
5.1 Overview	33
5.2 Device Wiring	33
5.2.1 Avoid Common Returns	33
5.2.2 Use Twisted Shielded Pair Wiring (with Overall Insulation)	35

Site Considerations for Equipment Installation, Grounding, and Wiring Manual

D301452X012

May 2024

5.2.3	Ground Cable Shields.....	35
5.2.4	Use Known Good Earth Grounds.....	35
5.2.5	Earth-ground Wires	36
5.2.6	Work Neatly and Professionally.....	36
5.2.7	Observe High Power Conductors and Signal Warning	36
5.2.8	Use Proper Wire Size	37
5.2.9	Use Lightning Arresters & Surge Protectors	37
5.2.10	Suppress Inductive Load Transients.....	38
5.2.11	Secure Wiring Connections	40

Chapter 6: Grounding and Bonding a Solar PV Array 41

6.1	Code Requirements	41
6.2	Ground Attachment	41
6.3	Non-Conductive Components	42
6.4	Non-Conductive Coatings	43
6.5	Grounding Method	43
6.6	Corrosion Protection.....	45
6.7	Lightning Protection Considerations	45

Chapter 1: Overview

This chapter covers the following topics:

- Safety Labels
- Major Topics

This document provides information pertaining to the installation of RTUs, controllers, and flow computers from Emerson Energy and Transportation Solutions, including the ROC, FloBoss™, and ControlWave® devices, the FB1000 and FB2000 Series of flow computers and the FB3000 RTUs. More specifically, this document provides information covering reasons, theory, and techniques for protecting your personnel and equipment from electrical damage. Your system equipment affects both the quality of service your company provides and many aspects of its operational safety. Loss of equipment means lost production and profits as well as increased expenses.

Note

Information contained in this document is for educational purposes. Emerson Remote Automation Solutions offers no warranties or guarantees on the effectiveness of the safety of techniques described herein. Where the safety of installations and personnel is concerned, refer to the National Electrical Code Rules and rules of local regulatory agencies.

1.1 Safety Labels



This product may display safety label(s) to identify potential hazards. The same types of notices appear within the documentation. Whenever you see an exclamation point (!) enclosed within a triangle (shown to the left), consult the documentation for additional safety information about the hazard and how to avoid it. The labels used are:

DANGER

MAY CAUSE DEATH

Observe all precautionary signs posted on the equipment.

Failure to do so may result in death or serious injury to personnel.

WARNING

DANGER TO PERSONNEL AND EQUIPMENT

Observed all precautionary signs posted on the equipment.

Failure to do so may result in injury to personnel or cause damage to the equipment.

⚠ CAUTION

DANGER TO PERSONNEL AND EQUIPMENT

Observed all precautionary signs posted on the equipment.

Failure to do so may result in injury to personnel or cause damage to the equipment.

⚠ SAFETY FIRST

General instructions and safety reminders.

1.2 Organization

Topics are covered in five chapters, each designed to pinpoint major areas of concern for the protection of personnel and site equipment:

- **Chapter 2 – Protection**

This chapter provides the reasons for protecting equipment systems. It presents an overview of the definition of quality, what we are trying to accomplish in the protection of site installations, how to satisfy the defined requirements, and considerations for the protection of personnel and equipment.

- **Chapter 3 – Earthing & Isolation**

This chapter provides information as to what constitutes a good earth ground, how to test and establish such grounds, as well as when and how to connect equipment to earth grounds.

- **Chapter 4 – Lightning Arresters & Surge Protectors**

This chapter presents technical and statistical information about lightning strikes, details how to determine the likelihood of a lightning strike, discusses protecting equipment and personnel during the installation of radios and antennas, and reviews the dangers to personnel and equipment when working with antennas. Included is a discussion on using lightning arresters and surge protectors along with overviews of how each device protects site equipment.

- **Chapter 5 – Wiring Techniques**

This chapter covers installing power and “measurement & control” wiring; includes information on unique situations, circulating ground and power loops, bad relays, and good wire preparation and connection techniques. In addition to presenting problems to avoid, this chapter lists rules of instrument wiring.

- **Chapter 6 – Grounding and Bonding of Solar Photovoltaic (PV) Arrays**

This chapter discusses grounding and bonding of solar PV arrays, and covers code requirements, ground attachment, and grounding methods.

Site Considerations for Equipment Installation, Grounding, and Wiring Manual

D301452X012

May 2024

Chapter 2: Protection

This chapter covers the following topics:

- Protecting Equipment Systems
- Protecting Equipment and Personnel
- Other Site Safety Considerations

2.1 Protecting Equipment Systems

Electrical equipment is susceptible to damage from a variety of natural and man-made phenomena. In addition to wind, rain and fire, the most common types of system and equipment-damaging phenomena are lightning, power faults, communication surges, noise and other electrical interference caused by devices such as radios, welders, switching gear, automobiles, etc. Additionally, there are problems induced by geophysical electrical potential and noise plus things that are often beyond our wildest imagination.

2.1.1 Quality is Conformance to Requirements

A quality equipment system is one that works reliably, safely and as purported by its manufacturer (and in some cases by the system integrator) as a result of good equipment design and well defined and followed installation practices. If we accept the general definition of quality as “conformance to requirements,” we must also accept the premise that a condition of “quality” cannot exist where requirements for such an end have not been evolved. In other words, you cannot have quality unless you have requirements that have been followed. By understanding the requirements for a safe, sound, and reliable equipment system, and by following good installation practices (as associated with the personnel and equipment in question), you enhance the operational integrity of the equipment and system.

Understanding the requirements for properly and safely installing equipment in various environments in accordance with good grounding, isolating, and equipment protection practices is fundamental for maintaining a system which is healthy for both the owner and customer.

Properly installed equipment is easier to maintain and operate and is more efficient and more profitable to our customers. Following good installation practices minimizes injury, equipment failure, and customer frustration that accompanies failing and poorly operating equipment (of even the finest design).

Additionally, personnel who install a piece of equipment add to or subtract from a system’s reliability based on their level of technical ability. Their understanding of the equipment, site conditions, and the requirements for a quality installation are essential to safety and success.

2.2 Protecting Equipment and Personnel

Installations must be performed in accordance with National Electrical Code Rules, electrical rules set by local regulatory agencies, and – depending on the customer environment (gas, water, and so on) – other national, state and local agencies. Additionally, installation at various customer sites may be performed in conjunction with a “safety manager” or utility personnel with hazardous materials (HAZMAT) training on materials present (or potentially present) as required by OSHA, the customer, and other regulatory agencies.

2.2.1 Considerations for Protecting Personnel

Always evaluate the site environment as though your life depends on it. Make sure that you understand the physical nature of the location where you will be working. *Table 2-1* provides a general guideline for evaluating an installation site.

Table 2-1: Considerations for Protecting Personnel

#	Guide
1	Indoor or outdoor: dress appropriately
2	If outdoor, what kind of environment, terrain, etc. Watch out for local insects and rodents (bees, spiders, snakes, etc.)
3	If indoor or outdoor: determine if there are any pieces of dangerous equipment or any processes which might be a risk to your safety
4	If in a tunnel, bunker, etc. watch out for a build-up of toxic or flammable gases. Make sure the air is good. Watch out for local insects and rodents (bees, spiders, snakes, etc.)
5	Hazardous or Non-Hazardous Environment: wear appropriate safety equipment and perform all necessary safety measures.
6	Before installing any equipment or power or ground wiring, make sure that there are no lethal (life-threatening) voltages between the site where the instrument is to be installed and other equipment (such as pipes or cabinets) or to earth itself.

7 Never assume that adjacent or peripheral equipment has been properly installed and grounded. Determine if this equipment and the RTU or flow computer can be touched simultaneously without hazard to personnel and/or equipment?

8 Be prepared. Before going to remote locations where there are few or no human inhabitants ask a few simple questions like, should I bring water, food, hygienic materials, first aid kit, etc?

9 Observe the work habits of those around you – for your own safety!

Some of the items that a service person should consider before ever going onsite can be determined by simply asking questions of the appropriate individual. Obviously other safety considerations can only be established at the installation site.

2.2.2 Considerations for Protecting Equipment

Always carefully evaluate the site installation/service environment and equipment. Understand the various physical interfaces you will be dealing with such as equipment mounting and supporting, RTU/flow computer analog and digital circuits, power circuits, communication circuits and various electrical grounds. *Table 2-2* provides a general guideline for evaluating the equipment protection requirements of an installation site.

Table 2-2: Considerations for Protecting Equipment

#	Guide	Reference
1	Environment: Class I, Division 2 – Non-incendive Environment: Class I, Division 1 - Intrinsically Safe Other: Safe or unrated area	See appendices in hardware instruction manual.
2	Earth Ground - Established by mechanical/electrical or both or not at all	See <i>Chapter 3</i>
3	Is the area prone to lightning strikes?	See <i>Chapter 4</i>
4	Are there surge suppressors installed or to be installed?	See <i>Chapter 4</i>
5	Are there overhead or underground power or communication cables in the immediate area?	See <i>Chapter 2.3</i>
6	Is there an antenna in the immediate area?	See <i>Chapter 4.1.2</i>

- | | | |
|---|--|------------------------|
| 7 | How close is other equipment? Can someone safely touch this equipment and the RTU/flow computer simultaneously? | See <i>Chapter 2.3</i> |
| 8 | Determine equipment ground requirements. How will the RTU/flow computer and its related wiring be grounded? Consider earth ground, circuit ground, conduit ground, and site grounds. | See <i>Chapter 3</i> |
| 9 | Are there any obviously faulty or questionable power or ground circuits? | See <i>Chapter 2.3</i> |
-

2.3 Other Site Safety Considerations

Identify overhead or underground power or communication cables prior to installing a new unit. Accidentally cutting, shorting or simply just contacting power, ground, communication or process control I/O wiring can have potentially devastating effects on site equipment, the process system, and or personnel.

Do not assume that it is safe to touch adjacent equipment, machinery, pipes, cabinets or even the earth itself. Adjacent equipment may not have been properly wired or grounded, may be defective, or may have one or more loose system grounds. Measure for voltage between the case of a questionable piece of equipment and its earth ground. If a voltage is present, something is wrong.

AC-powered equipment with a conductive case should have the case grounded. If you do not see a chassis ground wire, do not assume that it is safe to touch this equipment. If you notice that equipment has been grounded to pipes, conduit, structural steel, etc., you should be cautious.

Note

The policy of the American Water Works Association (AWWA) on the grounding of electric circuits on water pipes states: *"The American Water Works Association (AWWA) opposes the grounding of electrical systems to pipe systems conveying water to the customer's premises..."*



Important

If there is concern regarding how equipment is grounded, use a voltmeter to measure the potential difference between enclosures and a known ground at the site. While there are many conditions and safety standards that list specific safe levels, a prudent rule-of-thumb is the *10 volt threshold*. If the measurement between enclosures or any enclosure and ground is **greater** than 10 volts, **stop** and ask **why?** This difference is a sign that

there is likely an issue with the grounding system. Do not take chances: **investigate** the source of the difference.

Site Considerations for Equipment Installation, Grounding, and Wiring Manual

D301452X012

May 2024

Chapter 3: Earthing and Isolation

This chapter covers the following topics:

- Power and Ground Systems
- Importance of Good Grounds
- Earth Ground Connections
- Isolating Equipment from the Pipeline

3.1 Power and Ground Systems

Controllers and flow computers from Emerson Remote Automation Solutions support DC power systems. AC power supplies are not provided. Our devices typically include a chassis lug that accommodates up to a #4 AWG size stranded copper wire for establishing a connection to Earth ground.

3.2 Importance of Good Grounds

Controllers and flow computers are used in control systems that must operate continually and within their stated accuracy over long periods of time with minimum attention. Failures resulting from an improperly grounded system can become costly in terms of lost time and disrupted processes. A properly grounded system helps prevent electrical shock hazards resulting from contact with live metal surfaces, provides additional protection of equipment from lightning strikes and power surges, minimizes the effects of electrical noise and power transients, and reduces signal errors caused by ground wiring loops. Conversely, an improperly grounded system may exhibit a host of problems that appear to have no relationship to grounding. It is essential that the service technician have a good understanding of this subject to prevent needless troubleshooting procedures.

WARNING

Devices must be installed in accordance with the National Electrical Code (NEC) ANSI/NEPA-70. Installation in hazardous locations must also comply with Article 500 of the code. For information on the usage of these devices in a hazardous location, see the appropriate sections of the device-applicable hardware manuals. For information on units in Class 1, Device 1, Groups C & D hazardous locations, refer to the instruction manual for the respective devices.

3.3 Earth Ground Connections

To properly ground the device, the unit's chassis ground must ultimately be connected to a known good earth ground. Refer to *Establishing a Good Earth Ground* and *Ground Wire Considerations* in this chapter.

3.3.1 Establishing a Good Earth Ground

A common misconception of a ground is that it consists of nothing more than a metal pipe driven into the soil. While such a ground may function for some applications, it is not suitable for a complex system of sophisticated electronic equipment. Conditions such as soil type, composition, and moisture all have a bearing on ground reliability.

A basic ground consists of a 3/4-inch diameter rod with a minimum length of 8 feet driven into conductive earth to a depth of about 7-feet as shown in *Figure 3-1*. Use braided copper wire for the Earth connection. The end of the wire should be clean, free of any coating, and fastened to the rod with a clamp. Cover or coat this ground connection to protect it from the weather and the environment.

Figure 3-1: Basic Ground Rod Installation

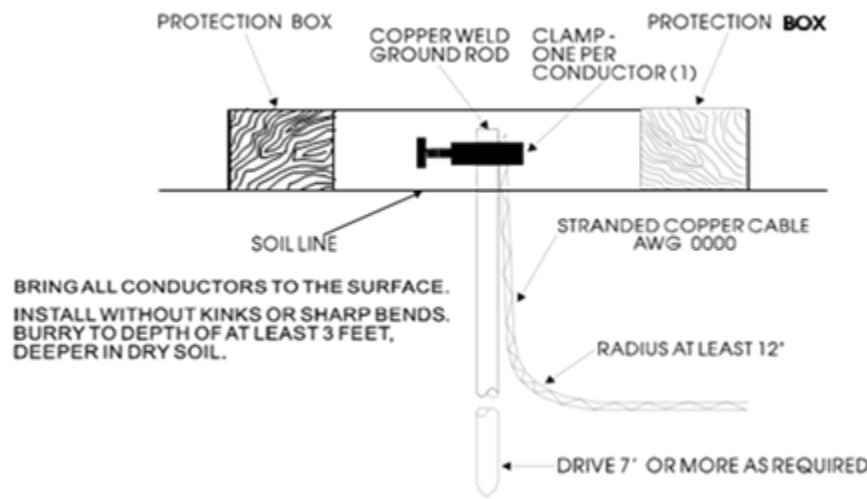

3.3.1.1 Soil Conditions

Before installing a ground rod, analyze the soil type and moisture content. Ideally, the soil should be moist and moderately packed throughout to the depth of the ground rod. However, some soils may exhibit less-than-ideal conditions and may require extra attention.

With respect to establishing and maintaining a good earth ground, soil types fall into either of two general categories: "good" soil and "poor" soil.

To be a good conductor, soil must contain some moisture and free ions (from salts in the soil). In rainy areas, the salts may be washed out of the soil. In sandy or arid areas the soil may be too dry and/or salt-free to be a good conductor. If salt is lacking, add rock salt (NaCl); if the soil is dry, add calcium chloride (CaCl₂).

3.3.1.2 Soil Types

Table 3-1 details good and poor soil types.

Table 3-1: Soil Types

Good	Poor
Damp Loam	Back Fill
Salty Soil or Sand	Dry Soil
Farm Land	Sand Washed by a Lot of Rain Dry Sand (Desert) Rocky Soil

Always test ground beds for conductivity **prior** to placing any equipment in service. This section provides a brief description of ground bed testing in both “good soil” and “poor soil.” Details on this test are described in the *National Electrical Code Handbook*. Once you establish a reliable ground, test it routinely to preserve system integrity.

Figure 3-2 shows the test setup for “good soil” conditions.

Figure 3-2: Basic Ground Bed Soil Test Setup

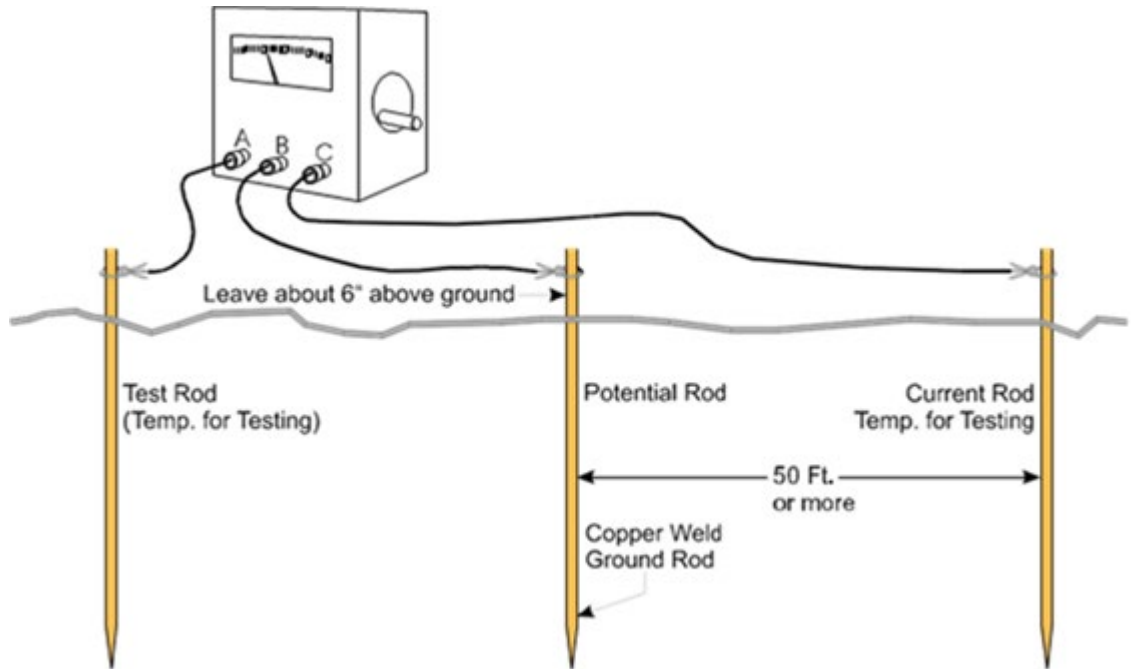

If the ground resistance testing unit (GRTU, such as a Meggar® High-Performance Ground Resistance Tester or an Associated® Research Vibroground®) reads *less* than 5 ohms, consider the ground “good”: the lower the resistance, the better the earth ground. If the GRTU reads *more* than 10 ohms, the ground is “poor.” If a poor ground is indicated, drive one or more additional ground rods connected 10 feet from the main ground rod into the soil and interconnect them via bare AWG 0000 copper wire and 1” x ¼-20 cable clamps (as shown in [Figure 3-3](#)).

Figure 3-3: Basic Ground Bed Soil Test Setup with Additional Ground Rods

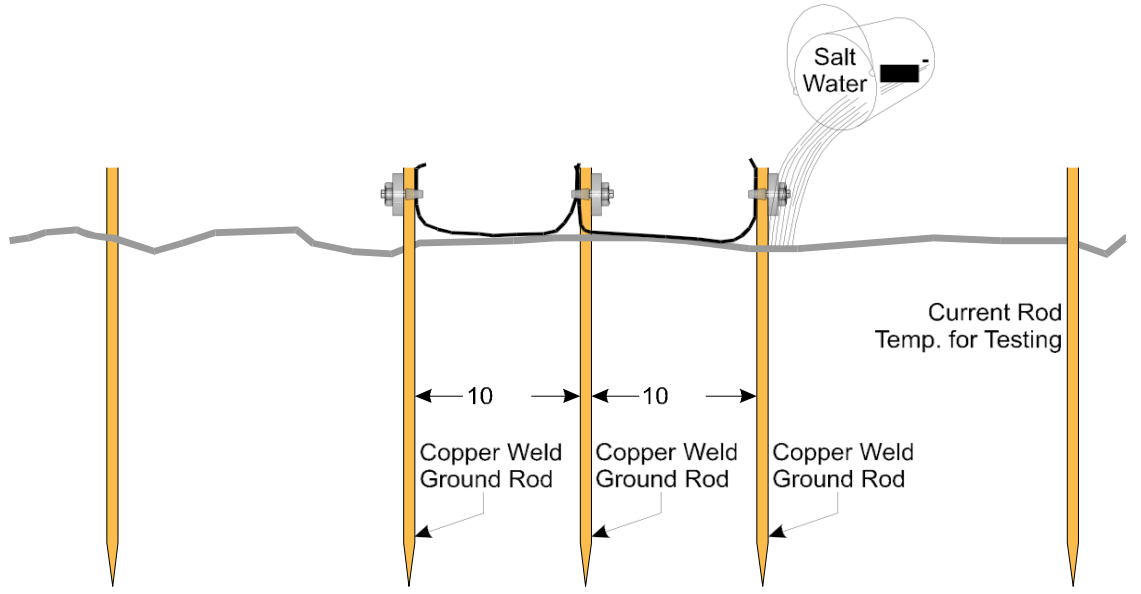

With the addition of the additional ground rods, if the GRTU still reads *more* than 10 ohms, mix a generous amount of cooking salt, ice cream salt, or rock salt with water and then pour about 2.5 to 5 gallons of this solution around each rod (including the test rods). Wait 15 minutes and re-test the soil. If the test fails, the soil is poor, and you must construct a “poor soil ground bed.”

Figure 3-4 shows a typical poor soil ground bed electrode. A poor soil ground bed typically consists of four or more 10-foot long electrodes stacked vertically and separated by earth. *Figure 3-5* shows the construction of a poor soil ground bed. For some poor soil sites, the ground bed is constructed of many layers of “capacitive couplings” as illustrated. In sites with *extremely* poor soil, you may have to bury one or more 3’ by 3’ copper plates (12 gauge or 1/16” thick) in place of the electrodes.

Figure 3-4: Ground Electrode Construction for Poor Soil Conditions

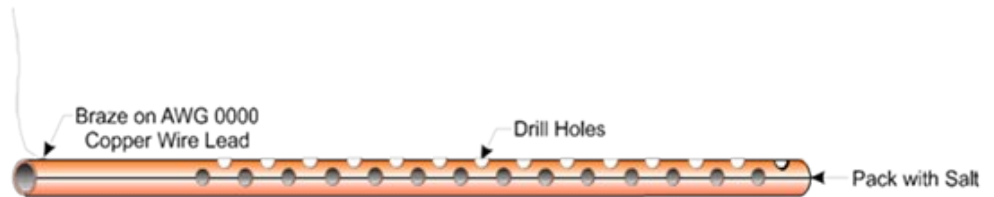

3.3.1.3 Dry, Sandy or Rocky Soil

A very dry soil does not provide enough free ions for good conductance, so a single ground rod is not effective. In these situations, a buried counterpoise or copper screen is recommended, and you must keep the soil moist through regular applications of water.

Sandy soil, either wet or dry, may have had its soluble salts leached out by rain water, thereby reducing ground conductivity. High currents from lightning strikes could also melt sand and cause glass to form around the ground rod, rendering the rod ineffective. For these installations, a buried counterpoise or copper screen is preferred along with regular applications of salt water.

Rocky soil can pose many grounding problems, probably requiring a counterpoise or copper plate. Constructing a trench at the grounding site and mixing the fill with a hygroscopic salt such as calcium chloride may help for a time. Soaking the trench with water on a regular basis also maintains conductivity.

Figure 3-5: Poor Soil Ground Bed Construction Diagram

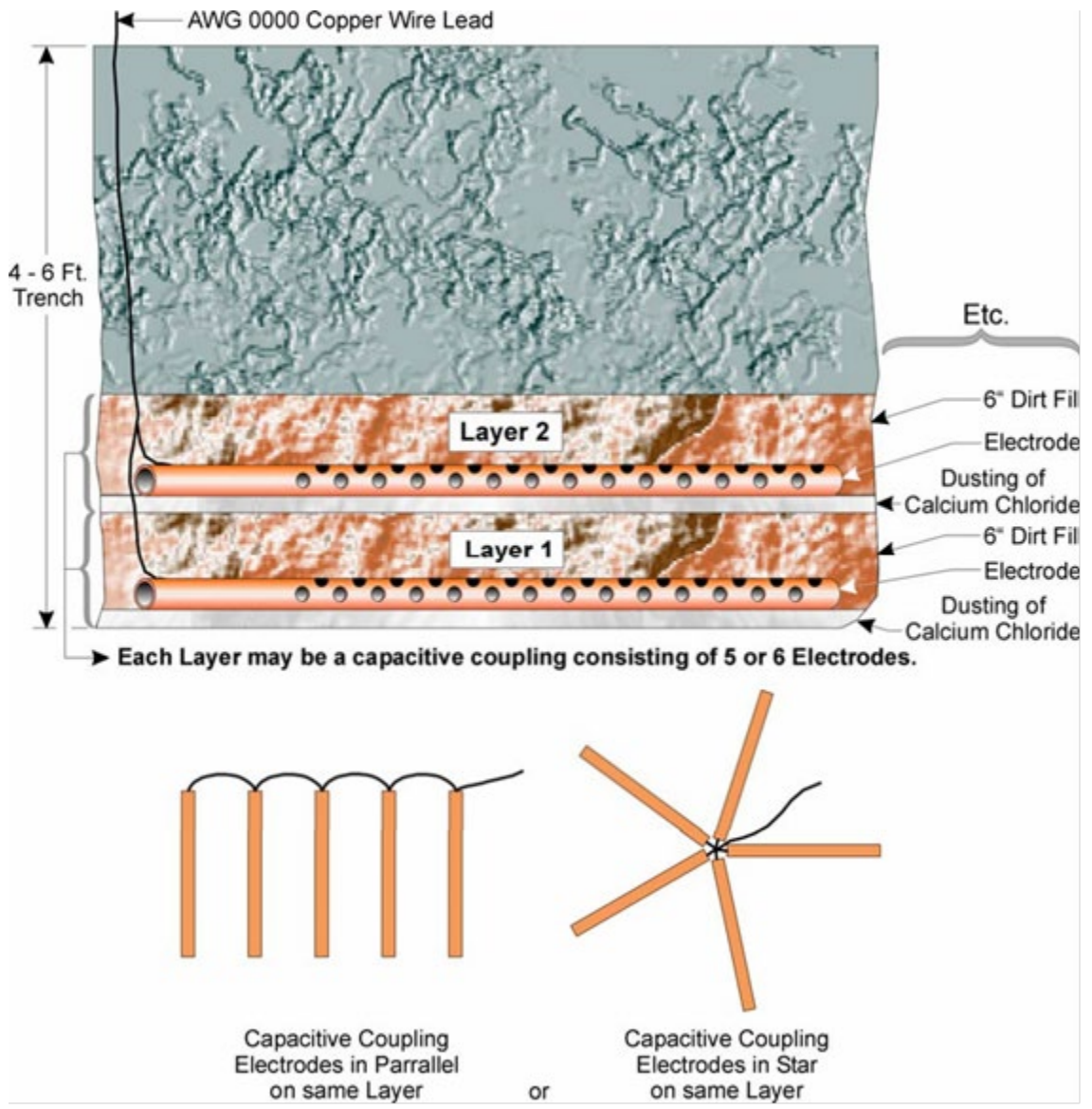

3.3.2 Ground Wire Considerations

Controllers and flow computers are provided with a chassis lug. Consult the instruction manual for the specific device for the proper wire size. You must run a ground wire between the chassis ground lug and a known good earth ground. The cases of the various modules are automatically connected to the chassis ground when they have been installed and secured in the chassis.

General Considerations

The following considerations are provided for the installation of controller/flow computer system grounds:

- Size of ground wire (running to earth ground) should be #4 AWG. It is recommended that stranded copper wire is used for this application and that the length should be as short as possible.
- Clamp or braise this ground wire to the ground bed conductor (which is typically a stranded copper AWG 0000 cable installed vertically or horizontally).
- Run the ground wire so that any routing bend in the cable has a *minimum* radius of 12 inches *below* ground and 8 inches *above* ground.

Clamp the unit earth ground cable to an exposed ground rod or to an AWG 0000 stranded copper ground cable that is in turn connected to either an earth ground rod or earth ground bed. Both ends of the unit earth ground cable must be free of any oxidation as well as any coating such as paint or insulated covering. The connecting point of the ground rod or AWG 0000 ground cable must also be free of any coating and free of oxidation. Once the ground connection has been established (at either the ground rod or ground cable) cover or coat it to protect it from the environment.

3.3.3 Other Grounding Considerations

For applications employing equipment that communicates over telephone lines, a lightning arrester **must be** provided. For indoor equipment the lightning arrester must be installed at the point where the communication line enters the building, as shown in [Figure 3-6](#). The ground terminal of this arrester must connect to a ground rod and/or a buried ground bed.

Figure 3-6: Grounding of Phone Line

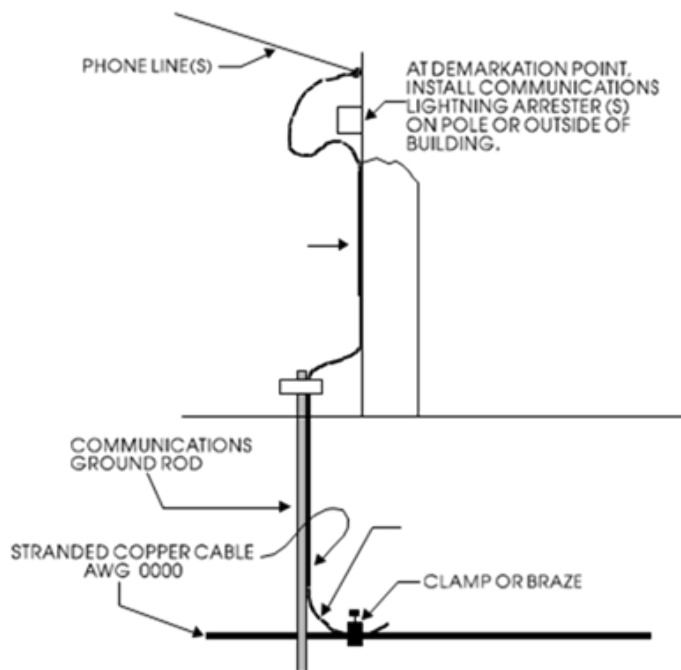

Gas lines also require special grounding considerations. If a gas meter run includes a thermocouple or RTD sensor installed in a thermowell, connect the well (not the sensor) to a gas discharge-type lightning arrester as shown in *Figure 3-7*.

Figure 3-7: Grounding of Thermometer Well in Gas Line

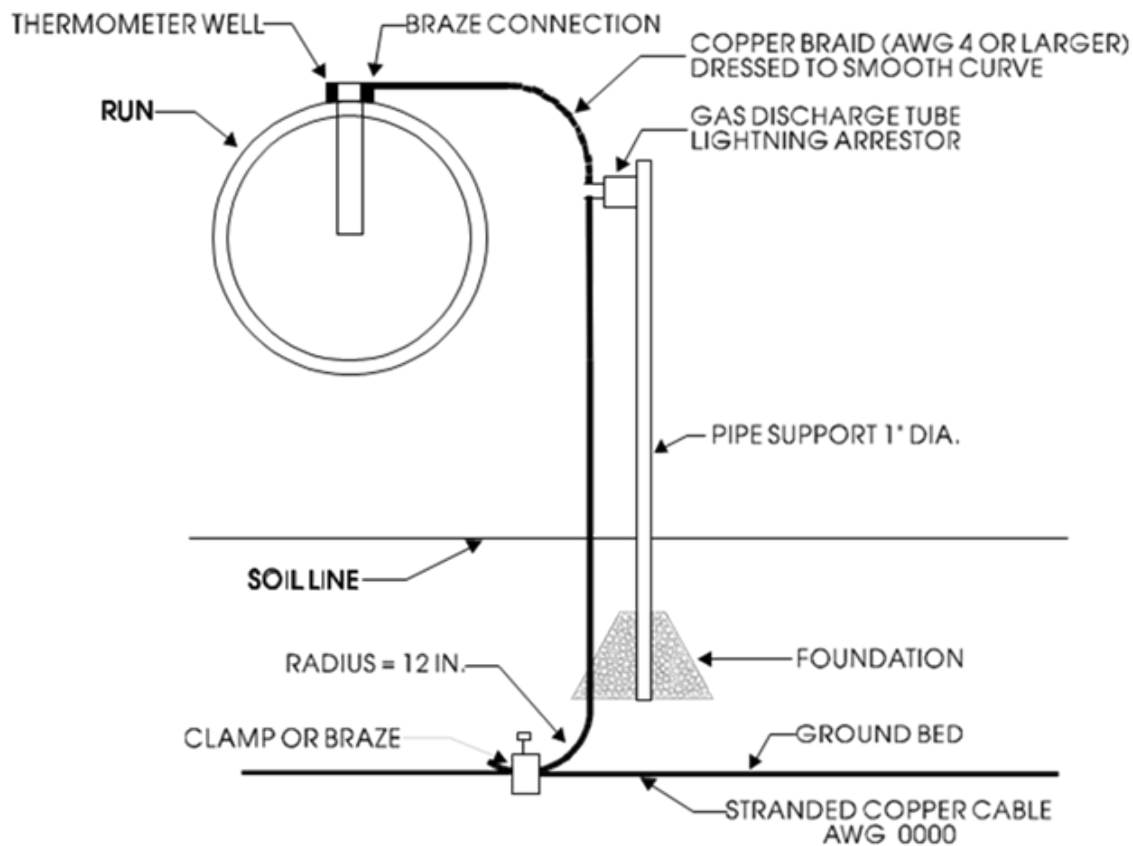

Dress a copper braid, brazed to the thermal well, into a smooth curve and connect it to the arrester as shown. The curve is necessary to minimize arcing caused by lightning strikes or high static surges. The path from the lightning arrester to the ground bed should also be smooth and free from sharp bends for the same reason.

3.4 Isolating Equipment from the Pipeline

3.4.1 Meter Runs without Cathodic Protection

Some (but not all) flow computers may be mounted directly on the pipeline. For example, you can mount the FB1100 and FB1200 flow computers directly on a pipeline using the traditional mounting kit or a coplanar mounting kit, but **only** if the pipeline includes a process manifold. If direct mount is not allowed or supported (as with the FB2100 and FB2200 flow computers), mount the flow computers remotely on a vertical standalone two-inch pipe (see *Figure 3-8*). Run the earth ground cable between the flow computer's

ground lug and earth ground (rod or bed) even though the flow computer's multivariable transducer may be grounded to the pipeline. If any pressure transmitters or pulse transducers are remotely mounted, connect their chassis grounds to the pipeline or earth ground.

Figure 3-8: Remote Installation without Cathodic Protection

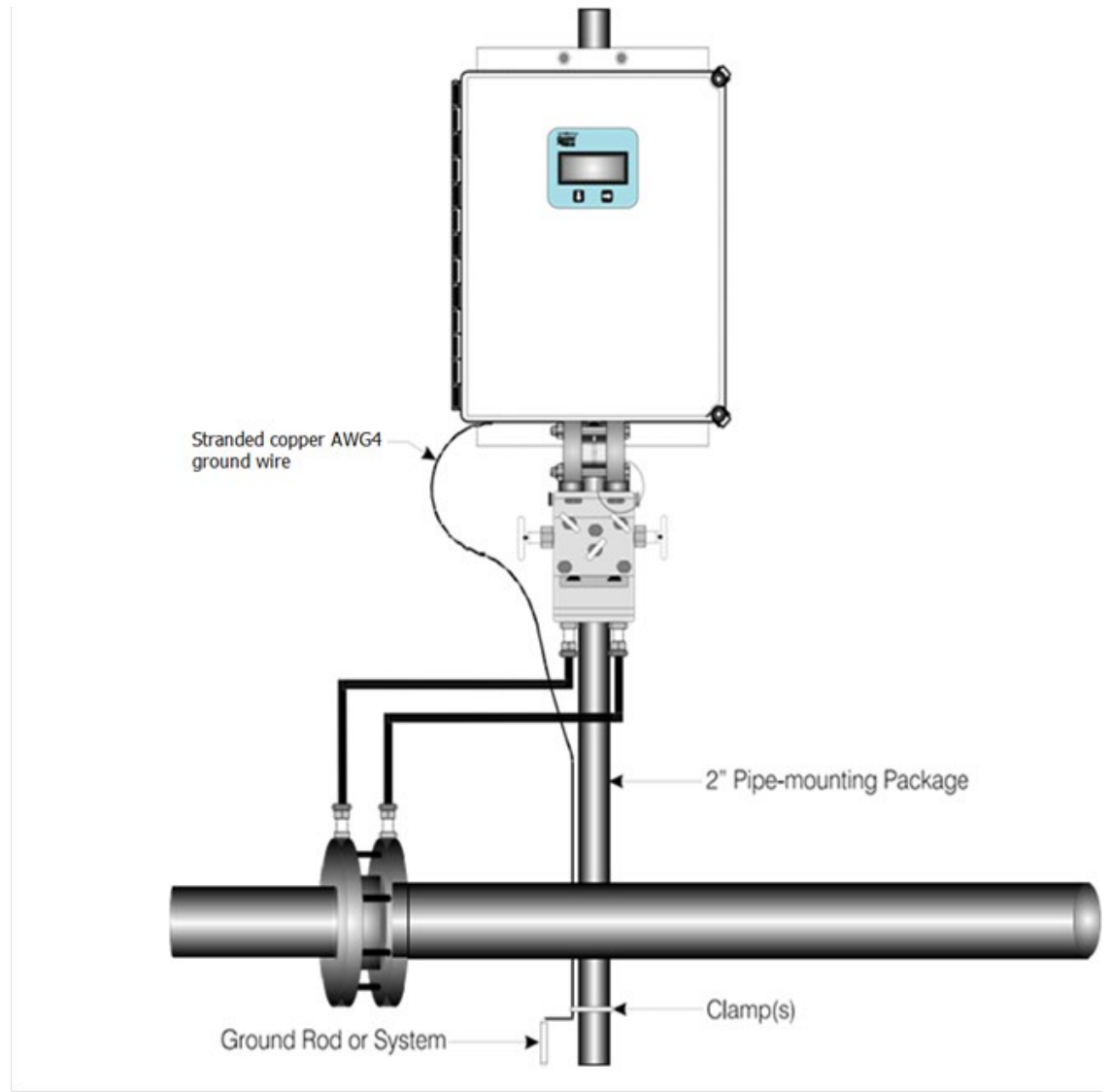

3.4.2 Meter Runs with Cathodic Protection

Dielectric isolators are available and are always recommended as an added measure in isolating the flow computer from the pipeline even though the flow computer does provide 500V galvanic isolation from the pipeline and should not be affected by cathodic protection or other EMF on the pipeline. Some (but not all) flow computers may be mounted directly on the pipeline (see *Figure 3-9*) or remotely on a vertical standalone two-

inch stand-pipe (see *Figure 3-10*). It is recommended that isolation fitting always be used in remotely mounted meter systems. Install isolation fittings or gaskets between the following connections:

- All conductive tubing that runs between the pipeline and mounting valve manifold and/or the unit's multivariable pressure transducer.
- All conductive connections or tubing runs between the flow computer and turbine meter, pulse transducer, or any other device that is mounted on the pipeline.
- Any Temperature Transducer, Pressure Transmitter, etc. and their mount/interface to the pipeline.

Figure 3-9: Direct Mount Installation (with Cathodic Protection)

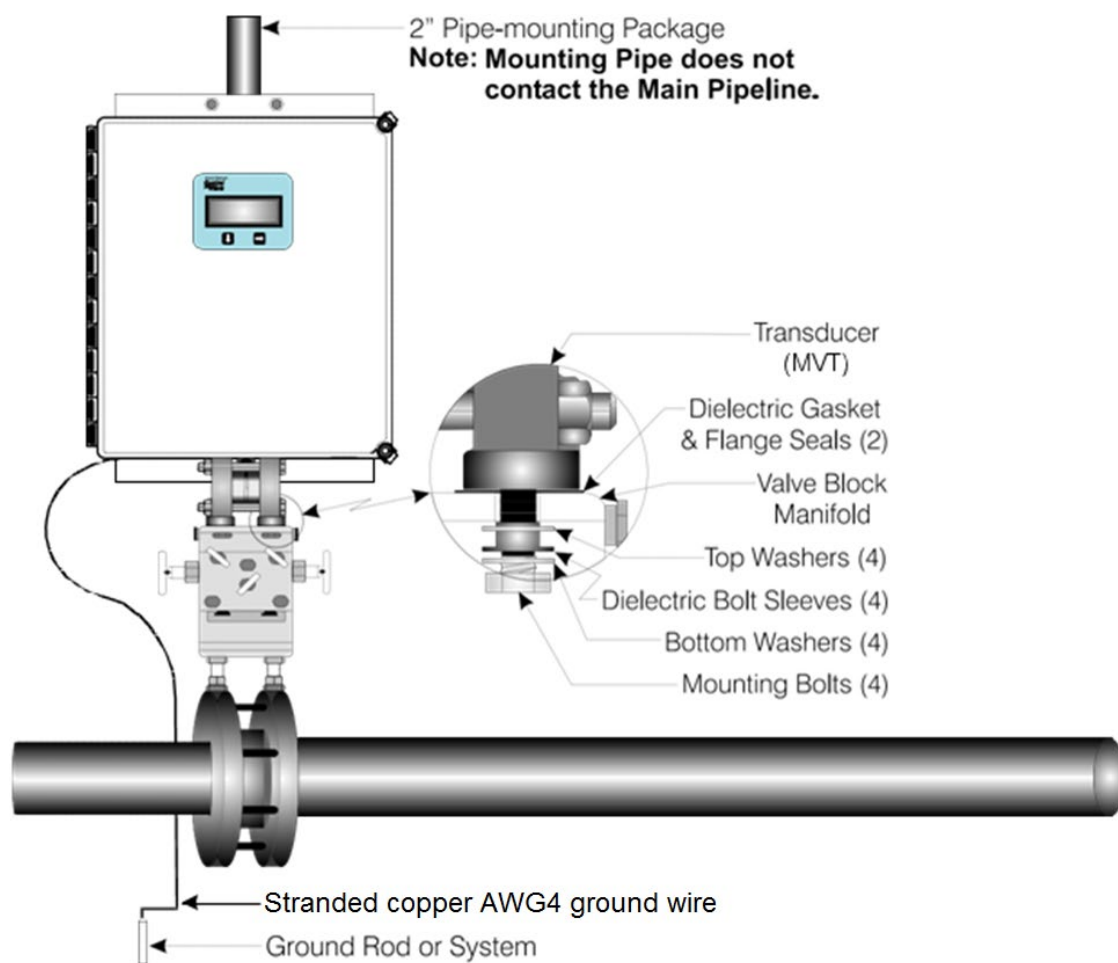

The ground conductor connects the ground lug and a known good earth ground. If present, connect the cases of temperature transducers or pressure transmitters to the known good earth ground. If the mounting 2-inch pipe is in continuity with the pipeline, it must be electrically isolated from the flow computer. Use a strong heat-shrink material (such as Raychem® WCSM 68/22 EU 3140). This black tubing easily slips over the 2-inch

pipe and then after uniform heating (as with a rose-bud torch) it electrically insulates and increases the strength of the pipe stand.

Figure 3-10: Remote Installation (with Cathodic Protection)

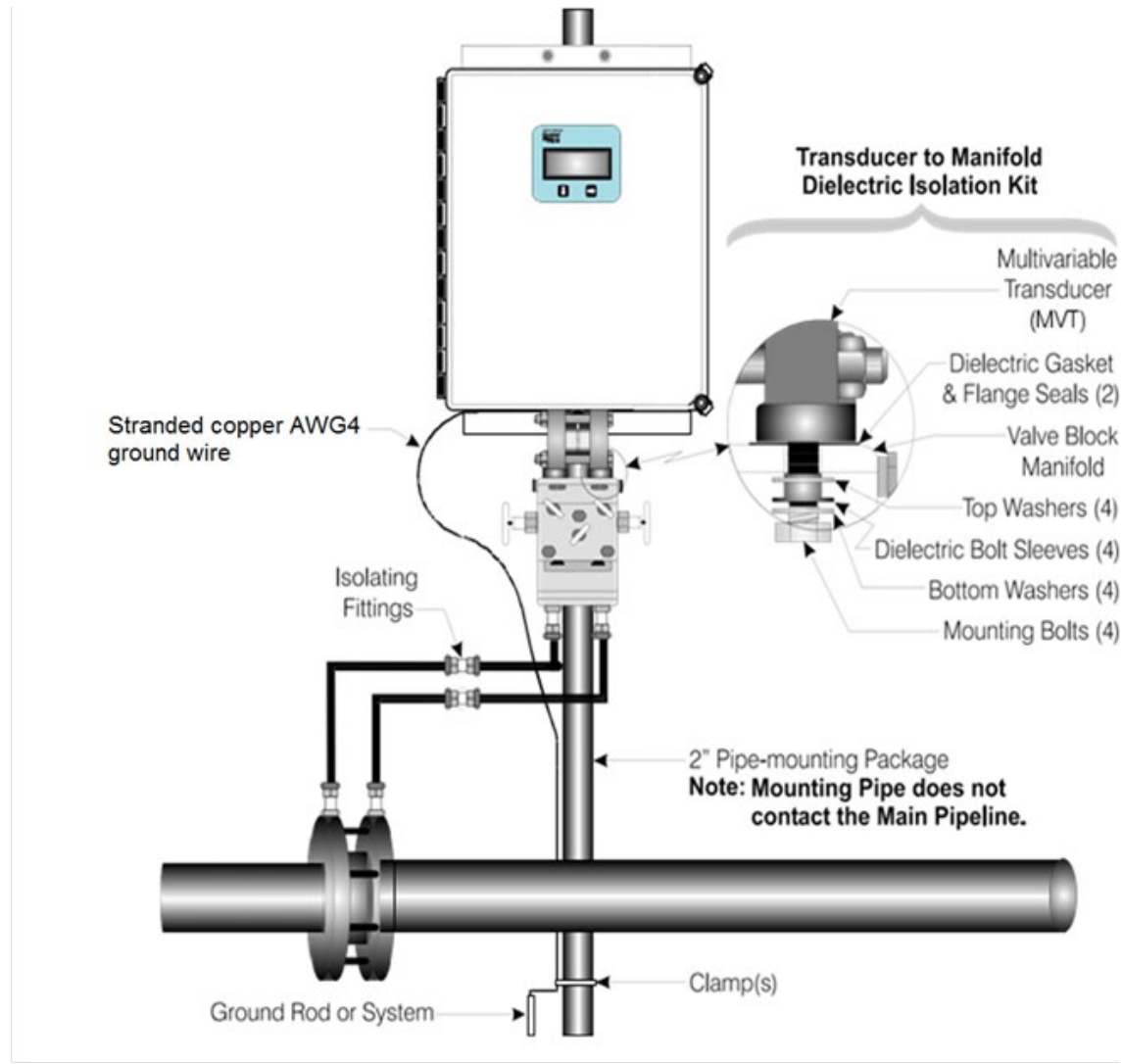

Chapter 4: Lightning Arresters and Surge Protectors

This chapter covers the following topics:

- Strike
- Use of Lightning Arresters and Surge Protector

4.1 Strike

Lightning takes the form of a pulse that typically has a 2 μs rise and a 10 μs to 40 μs decay to a 50% level. The IEEE standard is 8 μs by 20 μs waveform. The peak current will average 18 KA for the first impulse and about half of that for the second and third impulses. Three strokes (impulses) is the average per lightning strike. The number of visible flashes that may be seen is not necessarily the number of electrical strokes.

A lightning strike acts like a constant current source. Once ionization occurs, the air becomes luminous conductive plasma reaching up to 60,000° F. The resistance of a struck object is of little consequence except for the power dissipation on the object (I^2R). Fifty percent of all lightning strikes will have a first impulse of at least 18 KA, ten percent will exceed the 60 KA level, and only about one percent will exceed 120 KA.

4.1.1 Chance of Being Struck by Lightning

The map in *Figure 4-1* shows the average annual number of thunderstorm days (*isokeraunic* level) for the various regions within the continental U.S.A. This map is not representative of the severity of the storm or the number of lightning strikes since it does not consider more than one lightning strike in a thunderstorm day. The isokeraunic number provides a meteorological indication of the frequency of thunderstorm activity; the higher the Isokeraunic number the greater the lightning strike activity for a given area. These levels vary across the world from a low of 1 to a high of 300. Within the United States the Isokeraunic level varies from a low of 1 to a high of 100.

Figure 4-1: Chance of Being Struck by Lightning

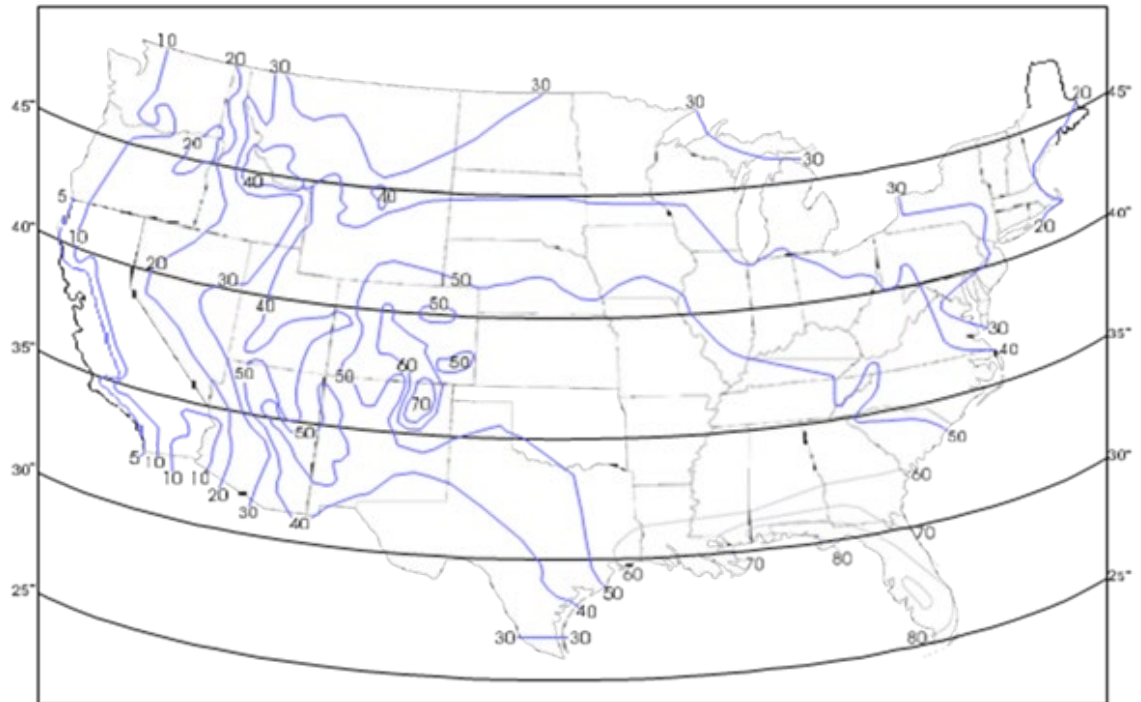

Thunderstorms are cloud formations that produce lightning strikes. Across the United States there is an average of 30 thunderstorm days per year. Any given storm may produce from one to several strikes. Data on the subject indicates that for an average area within the United States there can be eight to eleven strikes to each square mile per year. The risk of strikes activity is increased for various areas such as central Florida where up to 38 strikes to each square mile per year are likely to occur.

To determine the probability of a given structure (tower, building, etc.) within your location being struck, perform the following computation:

1. Using the map in *Figure 4-1* (or a comparable meteorological map for your location), find the isokeraunic level (*I*) for your area. Then using Chart 1 (located below), find **A** for your area.
2. Refer to *Figure 4-1* to find the latitude. Then using Chart 2, find **B** for your latitude (Lat.°).
3. Multiply **A** x **B** to get **C**.
4. To calculate the number of lightning strikes per year likely to strike a given object (tower, mast, etc.), use the following equation (where **C** was calculated in step 3 and **H** is equal to the height of the object):

$$\text{Strikes Per Year} = (C \times H^2) \div (0.57 \times 106)$$

Chart 1		Chart 2	
<i>I</i>	<i>A</i>	LAT.°	<i>B</i>
5	8	25	0.170
10	26	30	0.200
20	85	35	0.236
30	169	40	0.280
40	275	45	0.325
50	402		
60	548		
70	712		
80	893		
90	1069		
100	1306		

Note for these charts:

I = Thunderstorm Days Per Year (isokeraunic number)

A = Stroke activity for associated isokeraunic area

B = Height/Stroke coefficient for associated latitude

For Example: On Long Island, New York (isokeraunic number 20), Chart 1 indicates *A* to be **85**. The latitude is approximately **40°**. Chart 2 indicates *B* as **0.28**. For this example, *C* then equals **23.80**. Using the equation for strikes per year, it is determined that a 100-foot tower has 0.4 chances per year of being struck by lightning.

Assuming that no other structures are nearby, the tower will more than likely be struck by lightning at least once in three years.

Note

The isokeraunic activity numbers *I*, *A*, and *B* in *Charts 1* and *2* above are provided for the *continental* United States. Isokeraunic data for various countries is available from various federal or state civil engineering or meteorological organizations. This information is also typically available from manufacturers of lightning strike protection equipment (such as lightning arresters).

Since controllers and flow computers use DC operated systems that are isolated from AC grids, they are typically immune to lightning strikes to power lines or power equipment (except for inductive flashover due to close installation proximity). However, once a radio or modem has been interfaced to the controller or flow computer, you must consider the possibility of damage due to a lightning strike on power or telephone lines or to a radio antenna or the antenna's tower. We recommend that you follow the additional lightning protection considerations listed below for units installed in areas with a high possibility or history of stroke activity.

Units interfaced to a modem: In series with the phone line (as far away as possible from the equipment) - for indoor installations the lightning arrester should typically be located at the point where the line enters the structure.

Units interfaced to a radio: Mount antenna discharge unit (lightning arrester) as close as possible to where the lead in wire enters the structure. See [Antenna Caution](#) below.

4.1.2 Antenna Caution

Each year hundreds of people are killed, mutilated, or receive severe permanent injuries when attempting to install or remove an antenna or antenna lead. In many cases, the victim was aware of the danger of electrocution but failed to take adequate steps to avoid the hazard. For your safety, and for proper installation maintenance, please read and follow the safety precautions that follow - they may save your life.

- When installing or servicing an antenna:
 - **DO NOT** use a metal ladder. **DO NOT** step onto or touch an antenna mast while power is applied to an associated radio unless the radio is a low power (low current) type.
 - **DO NOT** work on a wet or windy day, especially during a thunderstorm or when there is lightning or thunder in your area. Dress properly; shoes with rubber soles and heels, rubber gloves, long sleeve shirt or jacket.
- The safe distance from power lines should be at least twice the height of the antenna and mast combination.
- Antenna Grounding per National Electrical Code Instructions:
 1. Use AWG 10 or 8 aluminum or AWG 1 copper-clad steel or bronze wire, or larger as ground wires for both the mast and lead-in. Be mindful of dissimilar metals resulting in a corrosion problem. Securely clamp the wire to the bottom of the mast.

2. Secure lead-in wire from antenna-to-antenna discharge (lightning arrester) unit and the mast ground wire to the structure (building, shed, etc.) with stand-off insulators spaced from 4 feet (1.22 meters) to 6 feet (1.83 meters) apart.
3. Mount antenna discharge unit as close as possible to where the lead-in wire enters the structure.
4. The hole drilled through the wall for the lead-in wire should be just large enough to accommodate the cable. Before drilling this hole, make sure there are no wires or pipes, etc. in the wall.
5. Push the cable through the hole and form a rain drip loop close to where the wire enters the exterior of the structure.
6. Caulk around the lead-in wire (where it enters the structure) to keep out drafts.
7. Install lightning arresters (antenna discharge units). The grounding conductor should be run in as straight a line as practicable from the antenna mast and/or the antenna discharge units to grounding electrode(s).
8. Only connect the antenna cable to the radio after the mast has been properly grounded and the lead-in cable has been properly connected to lightning arresters which in turn have each been properly connected to a known good earth ground.

Figure 4-2: Radio Antenna Field Installation Site Grounding

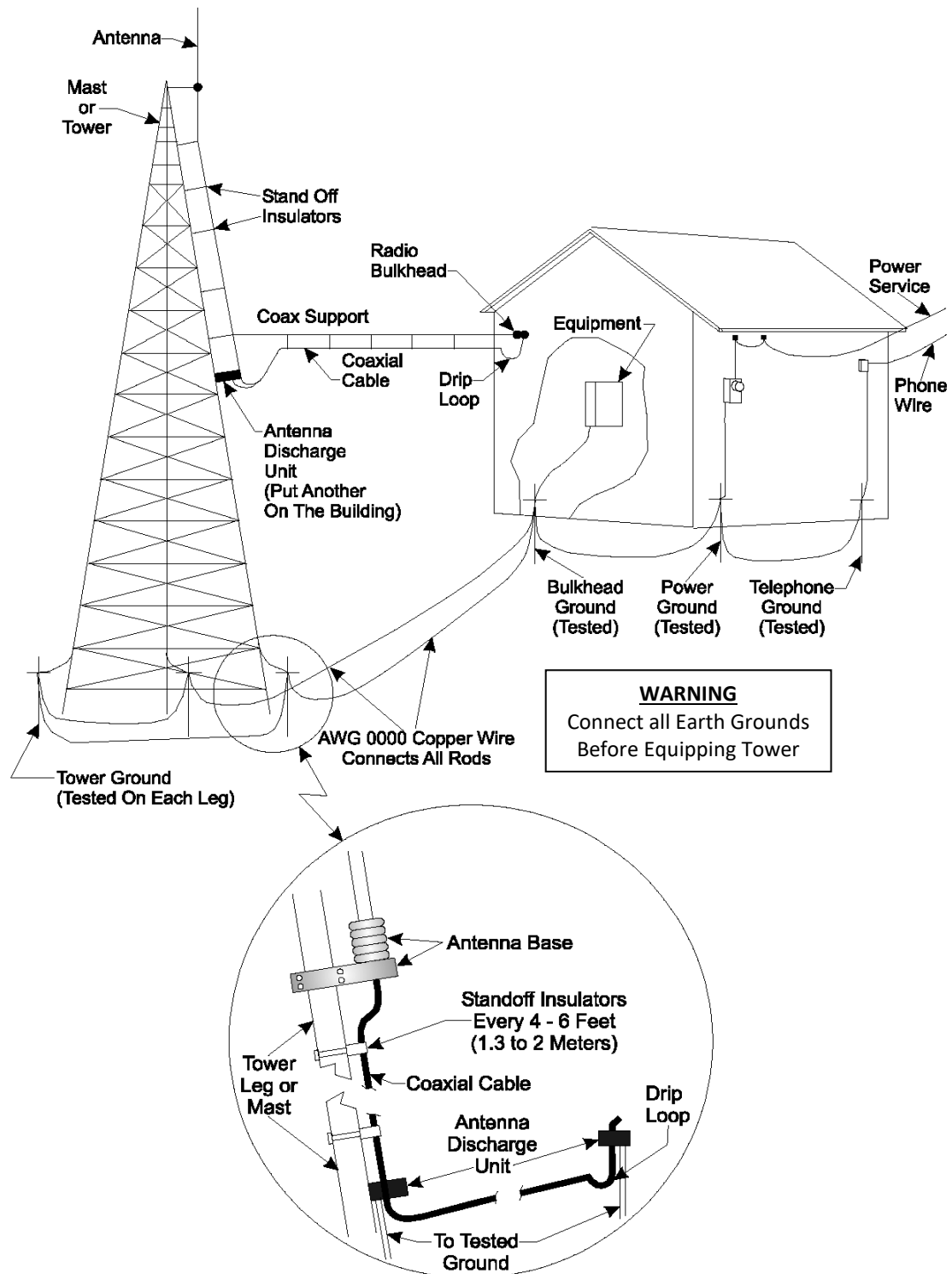

For all systems it is best to have all communication equipment input/output grounds tied together, following the recommendations in [Chapter 5](#). However additional

communication equipment such as lightning arresters and surge protectors should be tied to the same system earth ground. System earth ground consists of the tower leg grounds, utility ground, and bulkhead equipment ground stakes that are tied together via bare copper wire.

Note

If your site uses a phone modem, you must use a lightning arrester located at the point at which the communication line enters the building.

4.1.3 Ground Propagation

As in any medium, an energy pulse (such as a lightning strike) takes time to propagate. This propagation time causes a differential step voltage to exist in time between any two ground rods that are of different radial distances from the strike. With a ground rod tied to a struck tower, the impulse propagates its step voltage outwardly from this rod in ever-expanding circles, like a pebble thrown into a pond. If the equipment house has a separate ground rod and the power company and/or telephone company grounds are also separate, the dynamic step voltage causes currents to flow to equalize these separate ground voltages. Then if the coaxial cable (associated with a radio) is the only path linking the equipment chassis with the tower ground, the surge can destroy circuitry.

4.1.4 Tying it all Together

To prevent this disaster from occurring, you must form a grounding system which interconnects all grounds together. This equalizes and distributes the surge charge to all grounds and, at the same time, makes for a lower surge impedance ground system. This interconnection can be done as a grid (where each ground has a separate line to each other ground) or as a “rat race” ring (which forms a closed loop – although not necessarily a perfect circle – surrounding the equipment house).

By making this interconnection, you must use proper surge suppressors for the equipment (which is a requirement whether you use this grounding technique). Use I/O protectors for power lines (even those these don’t feed into a controller/flow computer), telephone lines, and to minimize EMI pick-up from a strike. Ideally it is best to place all I/O protectors on a common panel that has a low inductance path to the ground system. The controller/flow computer would then have a single ground point from its chassis ground terminal/ground lug to this panel. In lieu of this, the controller/flow computer in question should be tied to a ground rod that in turn is connected to the earth/system ground created for the site.

Once connected to a common earth ground system, your protected equipment is now like a bird sitting on a high-tension wire. When lightning strikes, even with a 50 ohm surge

impedance ground system, the *entire system* (equipment, ground system, building, etc.) rises *together* to the one million volt peak level (for example) and decays back down *together*. As long as there is no voltage differential (provided by protectors and ground interconnections), no current flows through the equipment and no equipment damage occurs.

4.1.5 Impulse Protection Summary

- Use more than one ground rod.
- Place multi-ground stakes more than their length apart.
- Tie power, telephone company, tower, bulkhead, and equipment grounds together.
- Ensure that all above-ground interconnect runs have minimum radius bends of eight inches, run away from other conductors, and use large solid wire or a solid strap.
- Watch out for dissimilar metals connections and coat accordingly.
- Use bare wire radials together where possible with ground stakes to reduce ground system impedance.
- Use I/O protectors (phone line, radio) with a low-inductance path to the ground system.
- Ground the coaxial cable shield (or use an impulse suppressor) at the bottom of the tower just above the tower leg ground connection.

4.2 Use of Lightning Arresters and Surge Protectors

Units equipped with radios or modems use lightning arresters and surge protectors to protect equipment from lightning strikes, power surges and from damaging currents that have been induced onto communication lines.

Lightning arresters are the first line of defense. These devices typically use gas discharge tubes that can shunt high currents and voltages to earth ground when they fire. The high-current, high-voltage gas discharge tube has a relatively slow response time and only fires when high voltage ionizes the gas.

Surge protectors are the second line of defense. These are solid state devices which fire very quickly and conducts low voltages and currents to ground. Surge protectors are built into some modems.

Apply lightning arresters to circuits as follows:

- Equipment or circuits that can be exposed to lightning strikes, falling power lines, high ground currents caused by power system faults, by operational problems on electric railways, etc.
- Equipment installed in dry, windy areas, such as the Great Plains and the Southwest Desert in the United States. Wind and windblown dust can cause high voltages (static) to appear on overhead wires, fences, and metal buildings.

Note

Lightning arresters may explode if a lightning strike is very close. Mount lightning arresters where flying parts will not cause injury to equipment or personnel.

4.2.1 Installing Lightning Arresters and Surge Protectors

- Install lightning arresters external to equipment cabinets, racks, or buildings.
- Each lightning arrester requires a separate ground connection to the nearest available earth ground. Use the manufacturer’s specified wire size.

Figure 4-3: Lightning Arresters and Surge Protectors

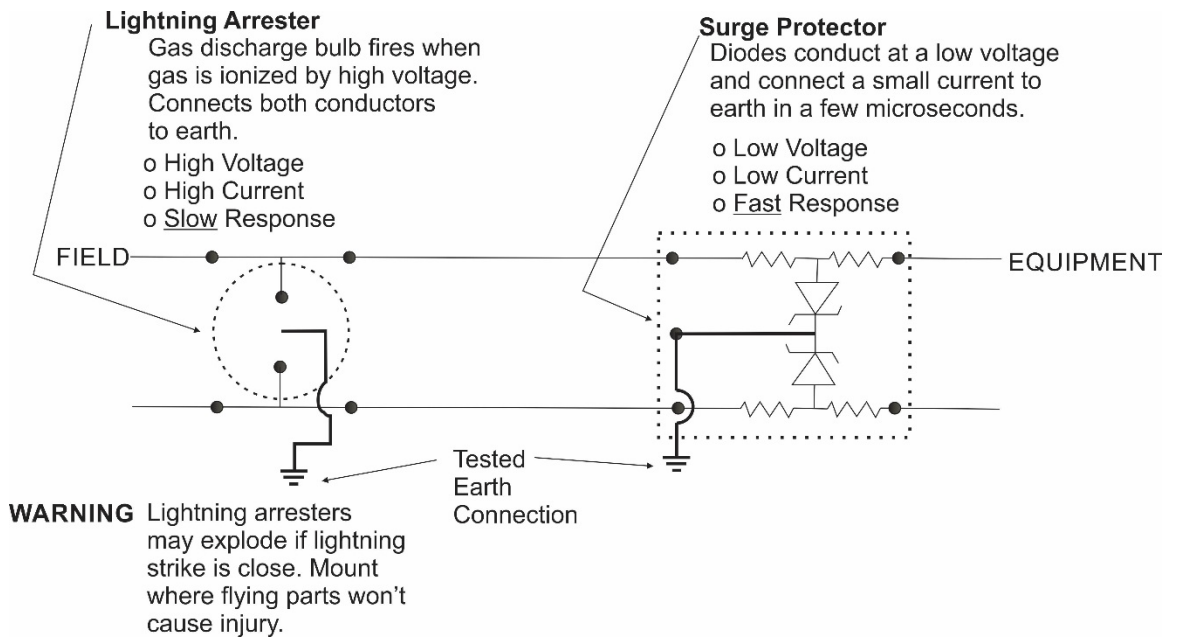

Figure 4-4: Protecting Equipment with Lightning Arresters and Surge Protectors

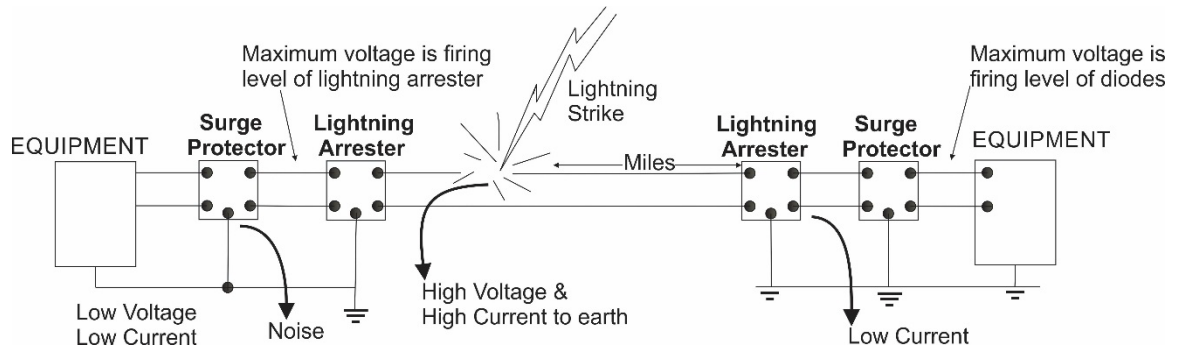
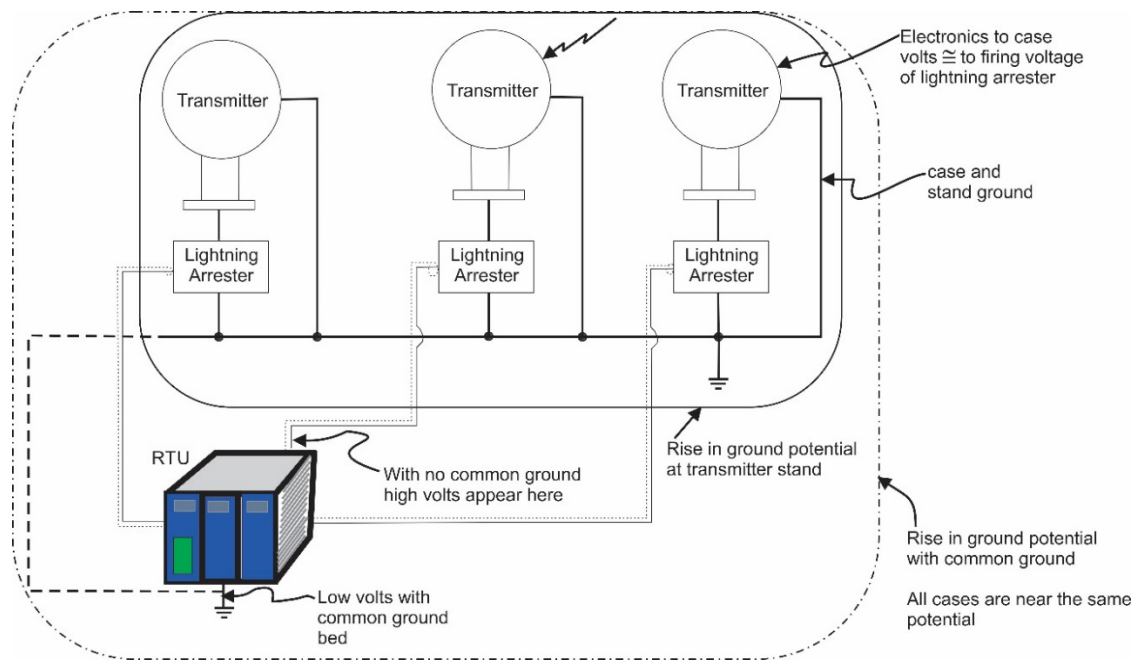

Figure 4-5: Protecting Equipment with Lightning Arresters



Chapter 5: Wiring Techniques

This chapter covers the following topics:

- Overview
- Instrument Wiring

5.1 Overview

This chapter provides information on good wiring practices, including good wire preparation and connection techniques. It also discusses the installation of power and “measurement & control” wiring, circulating and ground power loops, bad relays, and resolutions for common and uncommon problems.

5.2 Device Wiring

This section briefly discusses each of the following rules, placing emphasis on avoiding problems and assuring equipment safety.

Rule 1 – Earth and grounds are **not** power or signal returns.

Rule 2 – Never use common returns.

Rule 3 – Use twisted shielded pairs (with overall insulation) on all signal/control circuits.

Rule 4 – Ground cable shields at one end only.

Rule 5 – Use known good earth grounds (rod, bed, system) and test them periodically.

Rule 6 – Earth connections must use smoothly dressed large wire.

Rule 7 – Perform all work neatly and professionally.

Rule 8 – Route high power conductors away from signal wiring according to NEC rules.

Rule 9 – Use appropriately sized wires as required by the load.

Rule 10 – Use lightning arresters and surge protectors.

Rule 11 – Use suppression diodes for digital outputs connected to inductive loads.

Rule 12 – Make sure all wiring connections are secure.

5.2.1 Avoid Common Returns

Using common returns on I/O wiring is one of the most common causes of obscure and difficult-to-troubleshoot control signal problems. Since *all* wires and connections have

distributed resistance, inductance, and capacitance, using common returns considerably reduces the chances of achieving a balanced circuit or a balanced system. Balanced circuits and systems only occur when all currents and voltages developed in association with each of the common returns are equal. In a balanced system (or circuit) prevents the introduction of noise or measurement errors due to “sneak circuits.”

Figure 5-1 shows the difference between an I/O circuit that uses common returns (left-hand image) and one that uses separate dedicated returns (right-hand image). Common sense tells us that it is tough to mix up connections using a shielded twisted pair to every end device. To make start-ups easier, **do not use common returns**.

Figure 5-1. Field-wired Circuit with and without a Common Return

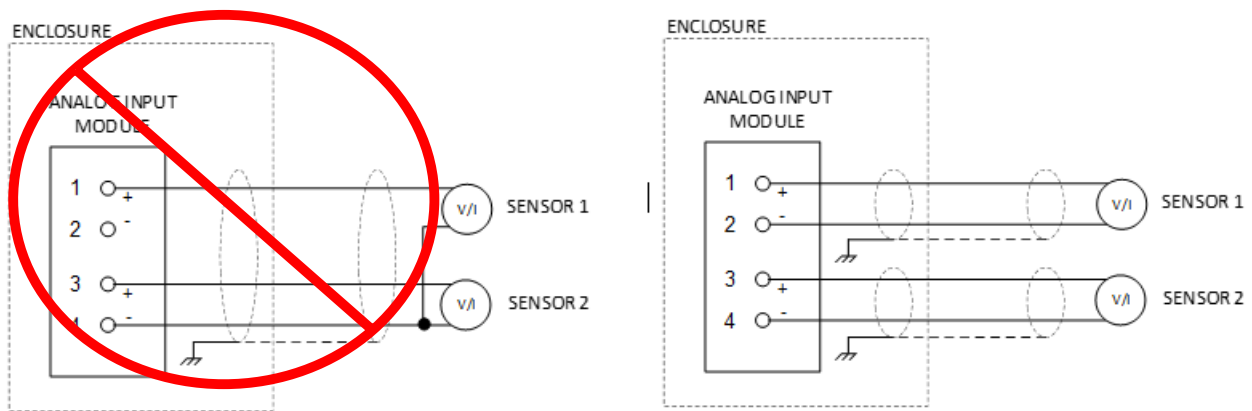
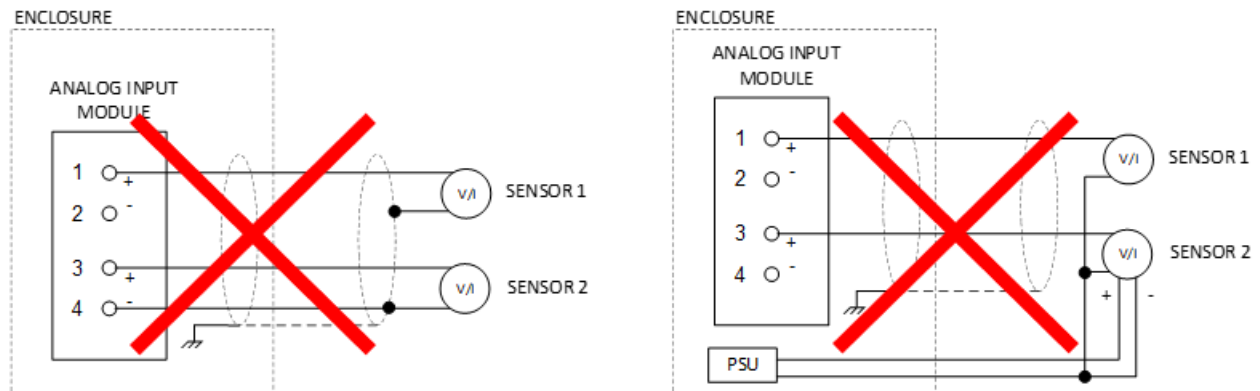

Figure 5-2 illustrates the **incorrect** use of grounds and returns. The left-hand image shows the sensor negative or return connected to the cable shield. Use shields as EMI drains and **not** as signal or power returns. The right-hand image shows the power supply return also being used as the sensor signal return. This directly couples any power supply and load noise into the measurement system. **Do not mix power with signal returns. Do not mix returns with grounds. Do not mix earth with signal or isolated grounds.**

Figure 5-2. Incorrect Usage of Returns and Grounds



Note

Without a common return, there are no sneak circuits and testing is easy.

5.2.2 Use Twisted Shielded Pair Wiring (with Overall Insulation)

For *all* field I/O wiring, we recommend using twisted shielded pairs with overall insulation. This type of cable provides insulation for the signal wires and an additional overall shield that provides greater E.M.I. immunity.

5.2.3 Ground Cable Shields

Do not connect the cable shield to more than one ground point; it should *only* be grounded at **one** end. Generally, the receiving side of the signal is the preferred shield terminal point. Cable shields that are grounded at more than one point or at both ends tend to induce circulating currents or sneak circuits that raise havoc with I/O signals. This occurs when the ground systems associated with multipoint connections to a cable shield have differing potentials (due to man-made error or natural phenomena).

5.2.4 Use Known Good Earth Grounds

Controllers/flow computers should only have **one** connection to earth ground; this connection is provided via the earth or chassis connection. Since these units are DC-based systems, grounding does not take into account AC power grounding considerations. Earth-grounding the unit is **mandatory** when the unit is equipped with a radio or modem. Additionally, connect units to earth grounds when they are installed in areas that have frequent lightning strikes; are located near or used in conjunction with equipment that is

likely to be struck by lightning; or, if struck by lightning, may cause equipment or associated system failure. Test and validate earth grounds as good before connecting to the controller/flow computer, and then periodically test and maintain earth grounds (refer to *Chapter 4* in this manual).

5.2.5 Earth-ground Wires

Earth connections must use smoothly dressed large wire. Use AWG 3 or 4 stranded copper wire with as short a length as possible. Exercise care when trimming the insulation from the wire ends. Ensure either that all internal wires are secured by crimping a lug onto the wiring or are secured in accordance with your organization's standards. Clamp or braze the earth ground wire to the ground bed conductor (typically a standard AWG 0000 copper cable). Run the earth ground wire so that any routing bend in the cable is a minimum 8-inch radius *above* ground or a minimum 12-inch radius *below* ground.

5.2.6 Work Neatly and Professionally

Take pride in your work and observe all site and maintenance safety precautions. After properly trimming the stranded pair wire ends, twist them in the same direction as their manufacturer did. Ensure either that all internal wires are secured by crimping a lug onto the wiring or are secured in accordance with your organization's standards. Install the wire end into its connector and then secure the associated connector's clamping screw. Remember to check these connections for tightness from time to time. If solid copper wire is use (in conjunction with the DC power system or for earth ground), make sure that the conductor is not nicked when trimming off the insulation. Nicked conductors are potential disasters waiting to happen. Neatly trim shields and coat them whenever possible to protect them and to prevent shorts and water entry.

Remember that loose connections, bad connections, intermittent connections, corroded connections, and other problems resulting from less-than-professional practices are hard to find, waste time, create system problems, and confusion in addition to being costly.

5.2.7 Observe High Power Conductors and Signal Warning

When routing wires, keep high power conductors away from signal conductors. Space wires appropriately to prevent electromagnetic coupling. If high and low voltage conductors must cross each other, ensure the angle between the conductors is as close to 90 degrees as possible. Refer to the National Electrical Code Handbook for regulatory and technical requirements.

5.2.8 Use Proper Wire Size

Allow some slack in the wires when making terminal connections. Slack makes the connections more manageable and minimizes mechanical strain on the printed circuit board (PCB) connectors. Provide external strain relief (using tie wrap, etc.) to prevent the loss of slack at the controller/flow computer.

Be careful to use wire that is appropriately sized for the load. Refer to the equipment manufacturer's specifications and the *National Electrical Code Handbook* for information on wire size and wire resistance. After installing the field wiring, test each load to determine if the correct voltage or current is present at the load. If you know the resistance of the field wires and the load current, you should be able to calculate the voltage drop. Conversely, if you know the minimum load voltage and current, you should be able to derive the maximum voltage loss that is allowable due to line resistance and then the correct wire size.

Referring to *Figure 5-3*, a relay that draws 100 mA, with a loop supply voltage of 24V and a total line resistance of 20 ohms, the load voltage (voltage across the relay) should be:

$$V_L = V_S - (V_C + V_C) \text{ where } V_C + V_C = (R_C + R_C) I$$

$$22 = 24 - 2 \quad \text{where } 2V = (20 \Omega) \times 0.1 A$$

Figure 5-3. Calculating Load Voltage due to Line Resistance

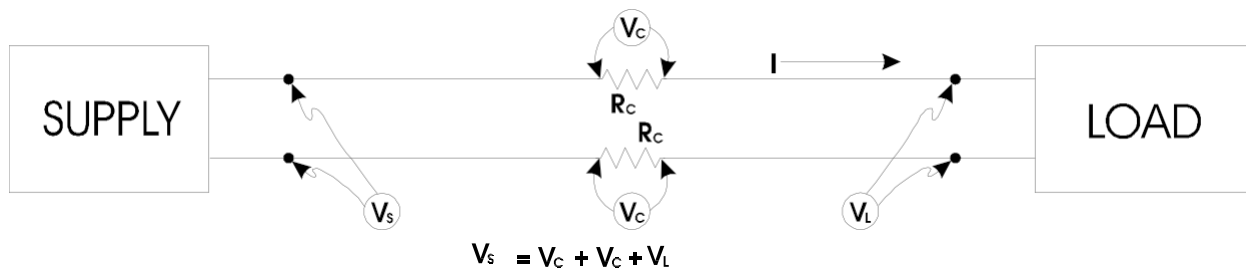

Note

In the figure above, V_c is the loss in the conductor. It is equal to the resistance of the conductors multiplied by the current through them.

5.2.9 Use Lightning Arresters & Surge Protectors

Use lightning arresters in association with any radio or modem equipped unit. Some modems are equipped with surge protection circuitry. Place lightning arresters or antenna discharge units on the base of the antenna and at the point where the antenna lead (typically coaxial cable) enters the site equipment building. When a modem is used, place a lightning arrester at the point where the phone line enters the site equipment building. If you use a modem that does not include surge protection circuitry, you should

also install a surge suppressors or lightning arrester on the phone line as close to the modem as possible. *Any unit interfaced to a radio or modem must be connected to a known good earth ground.*

5.2.10 Suppress Inductive Load Transients

Recalling two basic electrical principals:

- The voltage across a capacitor **cannot** change instantaneously
- The current through an inductor **cannot** change instantaneously

These two components store energy, and that energy cannot suddenly disappear because we open or close a switch. The energy needs to go someplace.

In the case of a capacitor:

$$i = C \frac{dv}{dt}$$

This formula states that the current through a capacitor is based on the value of the capacitor (F, uF, pF) multiplied by the rate of change of the voltage across its terminals. In practical terms, this means that attempting to force an instantaneous change in voltage *could* result in an infinite current.

For an inductor:

$$v = L \frac{di}{dt}$$

This equation states that the voltage across an inductor relates to the size of the inductor (H, uH, mH) multiplied by the rate of change of the current through it. The dual of the capacitor, we have a similar relationship except that attempting to instantaneously change the current through the inductor results in an infinite voltage across its terminals. Opening a switch to an inductor is how we make lightning! This is why arcing is usually seen when we open a switch or contactor controlling motors, transformers, or any electromagnetic (inductive) loads.

Figure 5-4. Transient Generated when the Current Through L1 is Interrupted

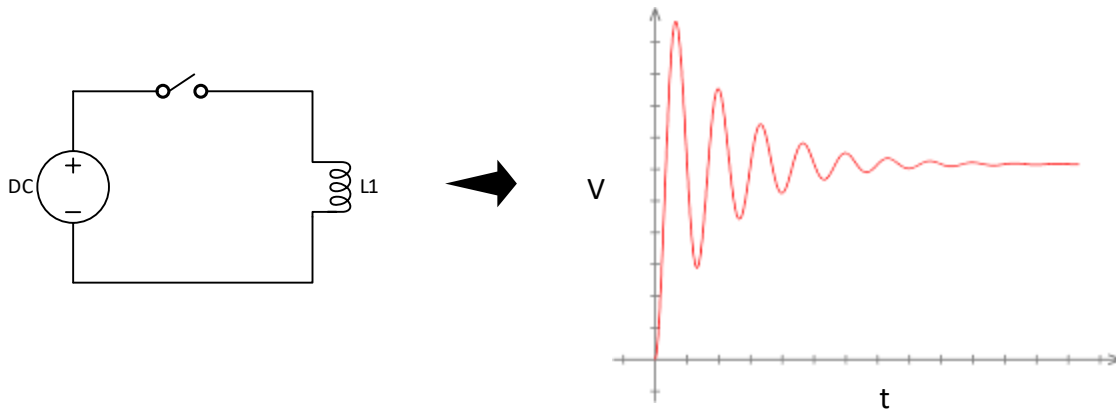

As shown in *Figure 5-4*, the voltage across L1 rises very rapidly as the switch is opened. Since di/dt is for all intents and purposes infinite (we went from some current to 0 current in 0 time), the voltage generated is limited only by lead resistances and capacitances but can reach hundreds or thousands of volts even for small relays or coils.

Somehow this voltage needs to be returned to its source. That “somehow” usually takes the form of stray capacitances, power supply returns, and sometimes grounds. When the transient energy returns through the power supply, all loads connected to that supply will “see” the same transient energy, which is where things go wrong. A typical microprocessor running on 3.3 or 5 volts has a tolerance or absolute maximum input voltage in the range of 6 to 8 volts. Imagine what can happen when that chip sees tens or hundreds of volts during these events. Sometimes, its indeterminate behavior: the data sheet values are severely exceeded, and the manufacturers will not guarantee any operations. In other obvious cases, permanent damage can result. There is a third, more insidious outcome: reduced product life expectancy.

While there are many ways to mitigate these effects, a simple option is to fit a reverse-biased diode (DC applications) or transient voltage surge suppressor (TVSS – AC applications) across the terminals of the coil as shown in *Figure 5-5*:

Figure 5-5. AC and DC Suppression Techniques

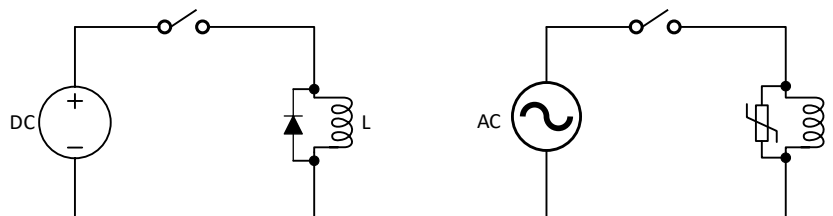

5.2.11 Secure Wiring Connections

Make sure that all wiring connections are secure. Over time, wires that were once round become flattened due to the pressure applied by screw compression type terminals and site vibrations. After a while these compression screws can become loose. Part of a good maintenance routine should be to check and tighten all screws associated with wiring terminal connections. Avoid nicking the wire(s) when stripping insulation. Remember, nicked conductors will lead to future problems. Also remember to provide some cabling slack and strain relief.

If installing stranded or braided wiring, be sure to tightly twist the end (in the same direction as manufactured). Ensure either that all internal wires are secured by crimping a lug onto the wiring or are secured in accordance with your organization's standards.

Chapter 6: Grounding and Bonding a Solar PV Array

This chapter covers the following topics:

- Code Requirements
- Ground Attachment
- Non-Conductive Components
- Non-Conductive Coatings
- Grounding Method
- Corrosion Protection
- Lightning Protection Considerations

6.1 Code Requirements

The National Fire Protection Association® (NFPA) Article 690.43 (2014 edition) addresses *Equipment Grounding*, and states: “*Equipment grounding conductors and devices shall comply with 690.43(A) through (F).*” Section (A) states: “*Exposed non-current-carrying metal parts of PV module frames, electrical equipment, and conductor enclosures of PV systems shall be grounded in accordance with 250.134 or 250.136(A), regardless of voltage.*” This requires you to appropriately ground the frame of the solar panel to earth. This is for safety reasons as well as lightning protection.

If the solar panel and powered equipment are being installed in a hazardous location (explosive environment, etc.), other more-stringent standards apply which are not covered in this section.

Note that remote outdoor electrical installations using solar power are also subject to the inspection and approval of the local electrical inspector. It is important to check with such local authorities to ensure compliance with all code requirements, guaranteeing both a safe and legal installation of equipment.

6.2 Ground Attachment

The actual grounding of the solar panel is straight-forward. *Figure 6-1* shows the location of the frame grounding point of a Model 30J 30W 12V solar panel where you made a connection to an earth ground through a suitable grounding conductor. Stranded 4 AWG

wire should be used for the grounding conductor to an established earth grounding electrode (as defined by NFPA 70 Article 250 Part III).

Figure 6-1. Model 30J 30W Solar Panel Protective Grounding

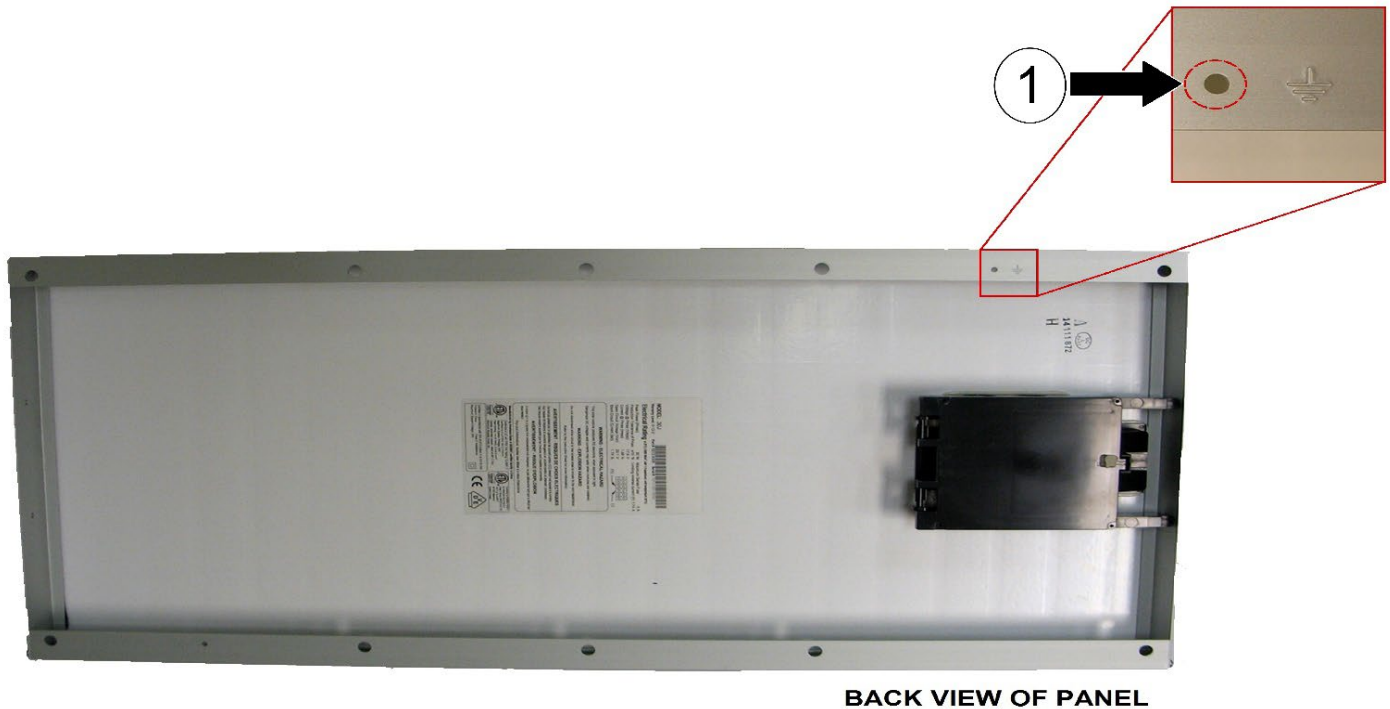

- 1 Spot face this area to remove anodizing prior to attaching ground wire in accordance with local electrical code requirements

Note that for other solar panels without a specific earth grounding point (like the Model 30J) you may employ any available mounting hole that is not already being used to mount the panel for this purpose or you may drill a new hole in an appropriate location.

6.3 Non-Conductive Components

Be wary of fiberglass and other non-conductive materials that may have been employed in the solar panel mounting assembly (such as for a mounting pole). These non-conductive components **cannot** serve as part of the electrical path between the solar panel mounting frame and earth ground. Bypass such components using a suitably sized electrical conductor to establish a *complete and uninterrupted* ground circuit between the solar panel frame and earth ground.

6.4 Non-Conductive Coatings

It is both important and necessary to ensure that you remove any non-conductive coatings present on the surface of the metal solar panel mounting frame from the contact area of the selected grounding point to ensure a good (low resistance) electrical connection. Solar panel frame components are typically aluminum or galvanized steel. Anodizing (a common surface treatment used to add corrosion resistance to aluminum) is an electrolytic passivation process which grows a surface layer of aluminum oxide over the aluminum. The resulting coating may be anywhere from a few microns (type I) to over a hundred microns (type III) thick depending upon the type of anodizing used. Anodizing provides a surface that is corrosion resistant, hard, and non-conductive and, unlike paint, is not easily worn away. Consequently, to establish a low resistance ground connection you must break through this surface to reach the underlying conductive aluminum. Either carefully abrade away the anodizing at the ground point or use sharp-edged stainless-steel star washers between the ring lug and the surface (see [Figure 6-2](#)) to break through the brittle anodized layer. You can apply these same methods to painted surfaces as well.

6.5 Grounding Method

Use a ring tongue terminal and 4 AWG wire to make the connection to the mounting frame of the solar panel. The ring tongue terminal should fit a #10 stud (similar to Molex® 0192210452). This connection is made using a #10 x ½" hardened steel self-tapping sheet metal screw as shown in [Figure 6-2](#):

Figure 6-2. Proper ground connection to the mounting frame of a solar panel

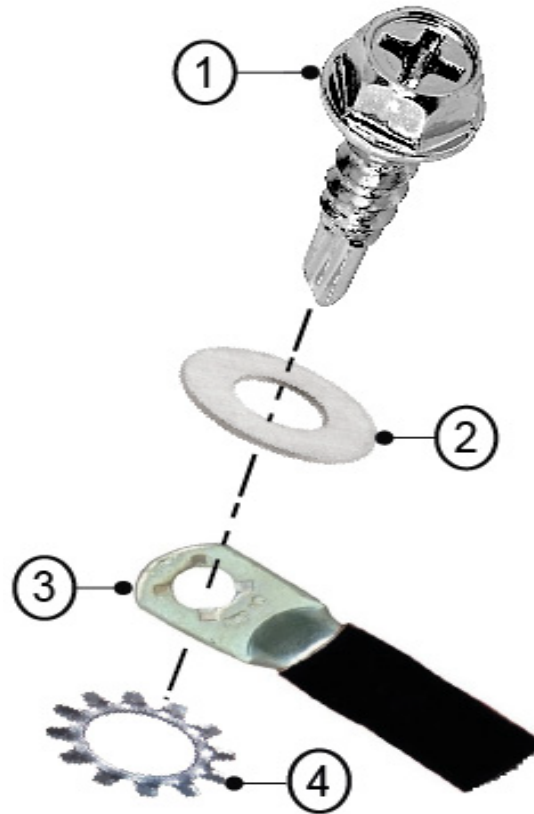

NOTE: All mounting hardware to be made from conductive, corrosion resistant materials.

- 1 #10 x 1/2" Self-Tapping Sheet Metal Screw
- 2 #10 Flat Washer
- 3 Stranded #4 AWG Wire
- 4 #10 Star Washer

Make the grounding conductor no longer than is necessary to safely and neatly make the connection between the panel frame and the earth grounding electrode. The connection at the earth-grounding electrode end of the grounding conductor varies depending upon the style of electrode used. It is usually some type of terminal assembly where the bare copper wire of the grounding conductor is inserted into an aperture and then clamped firmly in place by tightening a screw or bolt. Examples of earth grounding connectors can be found in catalogs (such as for McMaster-Carr® and Grainger® Industrial Supply). You can visit their website and search for these items under the category "Bonding and Grounding."

If you are mounting the solar panel to a metal pole that is already properly grounded to an earth grounding electrode, then it is only necessary to ensure the mounting frame of

the solar panel has a good, low-resistance electrical connection through the pole to the grounding electrode. Validate this by using an ohmmeter to measure the resistance from the frame itself to the grounding electrode. For a good connection, the resistance should measure less than 1 ohm.

6.6 Corrosion Protection

After you make all the grounding connections, address any areas where you removed anti-corrosion surface coatings to establish a good ground connection. Apply an exterior grade environmental protective coating suitable for use over electrical connections to these areas to prevent corrosion from degrading these carefully made ground connections. The coating chosen should be UV resistant, flame retardant, both non-conductive and non-toxic when dry, and be safe for use on wire insulation (plastics) and upon the materials comprising the solar panel frame.

6.7 Lightning Protection Considerations

As stated, the principal purpose of this ground connection to the solar panel mounting frame is to provide a path to ground in the event of a lightning strike to the panel and/or its mounting frame. However, it is also important to install lightning arresters and surge protection in the equipment being powered by the solar panel (if such devices are not already integral to that equipment). By diverting the resulting surge current to earth ground, these devices protect the internal electronics from being damaged by a lightning strike.

For detailed information on proper ground wiring and establishing a suitable proper earth ground, refer to *Chapter 3, Earthing and Isolation*. For information on lightning protection, refer to *Chapter 4, Lightning Arresters and Surge Protectors*.

Site Considerations for Equipment Installation, Grounding, and Wiring Manual

D301452X012

May 2024

For customer service and technical support, visit [Emerson.com/Guardian](https://www.emerson.com/Guardian).

North America and Latin America:

Emerson Automation Solutions
Energy and Transportation Solutions
6005 Rogerdale Road
Houston, TX 77072 U.S.A.
T +1 281 879 2699 | F +1 281 988 4445
[Emerson.com/SCADAforEnergy](https://www.emerson.com/SCADAforEnergy)

United Kingdom:

Emerson Process Management Limited
Fosse House, 6 Smith Way
Grover Park, Enderby
Leicester LE19 1SX UK
T +44 0 870 240 1987

Europe:

Emerson S.R.L
Regulatory Compliance Shared Services
Department
Company No. J12/88/2006
Emerson 4 Street
Parcul Industrial Tetarom 11
Romania
T +40 374 132 000

Middle East/Africa:

Emerson Automation Solutions
Energy and Transportation Solutions
Emerson FZE
P.O. Box 17033
Jebel Ali Free Zone – South 2
Dubai U.A.E.
T +971 4 8118100 | F +971 4 8865465

Asia-Pacific:

Emerson Automation Solutions
Energy and Transportation Solutions
1 Pandan Crescent
Singapore 128461
T +65 6777 8211 | F +65 6777 0947

© 2005-2024 Bristol Inc. All rights reserved.

This publication is for informational purposes only. While every effort has been made to ensure accuracy, this publication shall not be read to include any warranty or guarantee, express or implied, including as regards the products or services described or their use or applicability. Bristol Inc. (hereinafter “Energy and Transportation Solutions” or ETS) reserves the right to modify or improve the designs or specifications of its products at any time without notice. All sales are governed by ETS terms and conditions which are available upon request. ETS accepts no responsibility for proper selection, use or maintenance of any product, which remains solely with the purchaser and/or end-user. Emerson and the Emerson logo are trademarks and service marks of Emerson Electric Co. All other marks are the property of their respective owners.