

Micro Motion™ F-Series Coriolis Flow and Density Meters



Detailed specifications

F-Series flow and density accuracy options

Model	Liquid mass flow accuracy				Liquid density accuracy (g/cm ³)			Gas mass flow accuracy	
	±0.05% ⁽¹⁾	±0.1%	±0.15%	±0.2%	±0.0005 ⁽¹⁾	±0.001	±0.002	±0.35%	±0.5%
F025		•	•	•		•	•		•
F050	•	•	•	•	•	•	•	•	
F100	•	•	•	•	•	•	•	•	
F200	•	•	•	•	•	•	•	•	
F300	•	•	•	•	•	•	•	•	
F400	•	•	•	•	•	•	•	•	

(1) Not available on all models

High temperature and high pressure models (base model codes A, B, and P, for example, F050A) are not capable of enhanced density accuracy of 0.0005 g/cm³ (0.5 kg/m³).

Flow tube information

Model	Number of tubes	Tube inside diameter inches	Tube inside diameter mm	Tube length inches	Tube length mm
F025	2	0.21	5.3	14.6	370
F050	2	0.35	8.8	18.8	478
F100	2	0.65	16	25.1	637
F200	2	1.1	27	23.5	598
F300	2	1.6	40	34.4	874
F400	2	2.3	57	40.9	1,039

ASME B16.5 specification flange compatibility

Model	0.5 in	0.75 in	1 in	1.5 in	2 in	3 in	4 in
F025	•	•	•				
F050	•	•	•				
F100			•	•	•		
F200				•	•	•	
F300						•	•
F400							•

DIN specification flange compatibility

Model	DN15	DN25	DN40	DN50	DN80	DN100
F025	•					
F050	•	•				
F100		•				
F200			•	•		
F300					•	•
F400						•

EN1092-1 specification flange compatibility

Model	DN15	DN25	DN40	DN50	DN80	DN100
F025	•	•				
F050	•	•				
F100		•				
F200			•	•		
F300					•	•
F300					•	•
F400						•

JIS B 2220 specification flange compatibility

Sensors with JIS process connections do not meet ASME B31.1 power piping code.

Model	15mm	25mm	40mm	50mm	80mm	100mm
F025	•					
F050	•					
F100		•				
F200			•	•		
F300					•	•
F400						•







VCO/VCR specification flange compatibility and Tri-Clamp® compatible flanges

Model	VCO specification				Tri-Clamp compatible					
	#4	#8	#12	#16	0.5 in	0.75 in	1 in	1.5 in	2 in	3 in
F025		•	•		•	•				
F050		•	•		•	•				
F100				•			•			
F200								•	•	
F300										•

NAMUR NE132 compliant flanges

Model	DN15	DN25	DN50	DN80	DN100
F025	•				
F050	•	•			
F100		•			
F200			•		
F300				•	•
F400					•

Transmitter compatibility

Model	Transmitter						
	1500/2500	1700/2700	2400S	3000 series	FMT	4200	5700
							
All F-Series models	•	•	•	•	F025, F050, F100	•	•

Process pressure ratings

Sensor maximum working pressure reflects the highest possible pressure rating for a given sensor. Process connection type and environmental and process fluid temperatures may reduce the maximum rating. For common sensor and fitting combinations, refer to the *Micro Motion F-Series Flow and Density Meters Technical Data Sheet*.

All sensors comply with Council Directive 2014/68/EU on pressure equipment.

Note

F-Series sensors with JIS process connections do not comply with ASME® B31.1 power piping code.

Sensor maximum working pressure for all models

The following table shows maximum working pressure using 316L stainless steel (S/A), nickel alloy C22 (H/B), and high pressure (P).

Model ⁽¹⁾	Pressure
F025S/A, F050S/A, F100S/A, F200S, F300S, F400S	1,450 psig (100 barg)
F025H/B, F050H/B, F100H/B, F200H, F300H	2,160 psig (149 barg)
F025P	2,320 psig (160 barg)
F050P	5,800 psig (400 barg)
F100P	6,250 psig (431 barg)

(1) Higher pressure ratings may be available. Contact the factory for further information.

Temperature and pressure de-ratings

Note

- The ratings in this section apply to the combined sensor and process connection to ensure that the meter does not exceed the limits of either component.
- The temperature and pressure de-ratings graphs do not represent all possible model and fitting combinations. For combinations not listed here, contact a sales representative or the factory.

F025S–F400S—ASME B16.5 F316/F316L

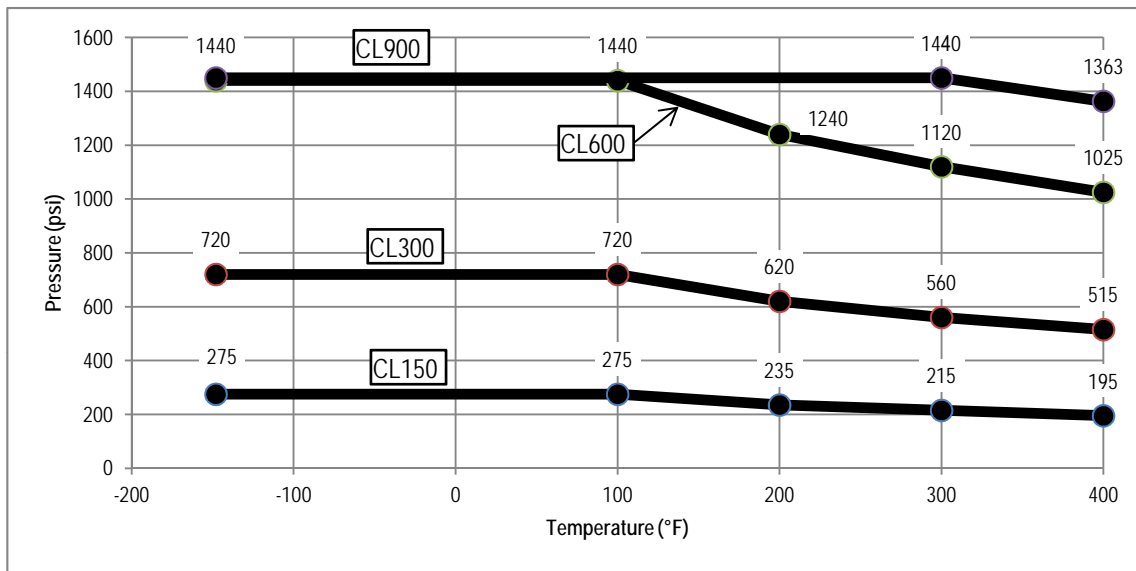

CL1500: F025S–F200S—ASME B16.5 F316/F316L

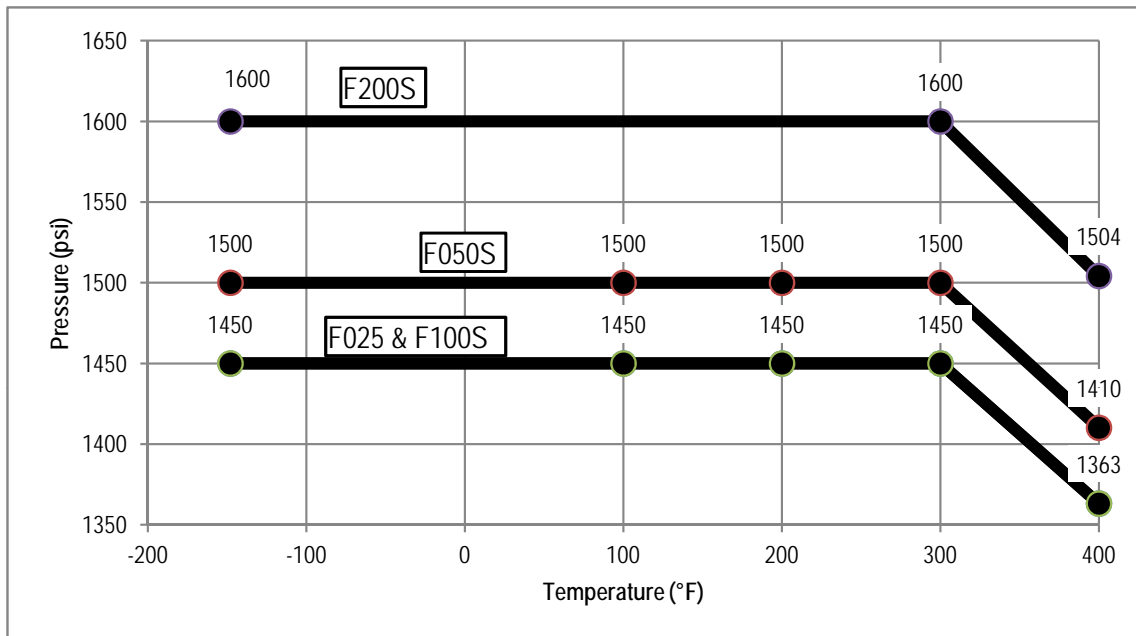

F025H–F300H—ASME B16.5 F304/F304L

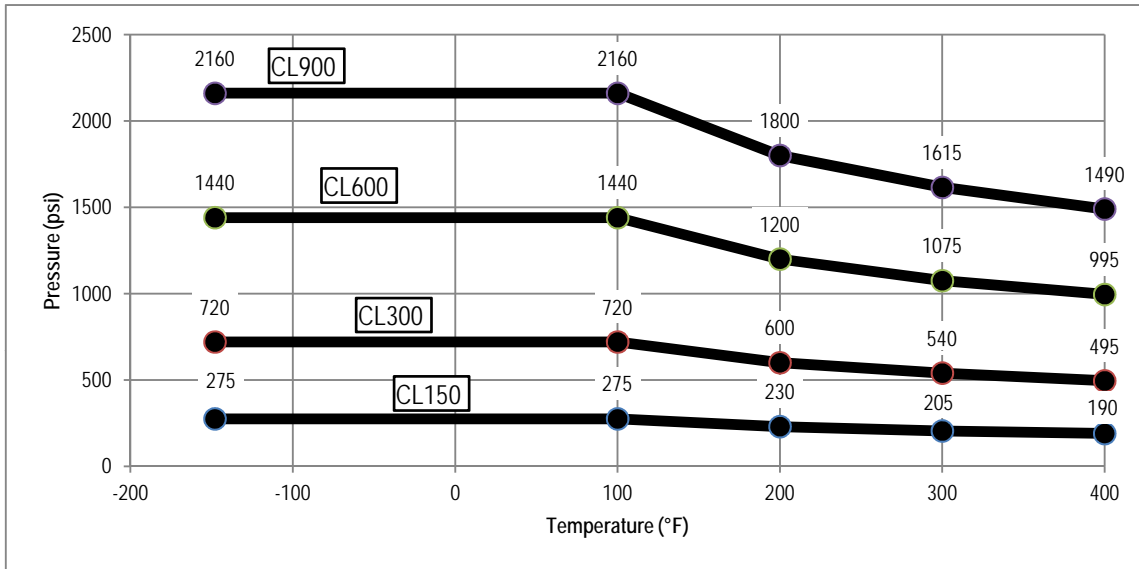

CL900/1500: F025H–F200H—ASME B16.5 F304/F304L

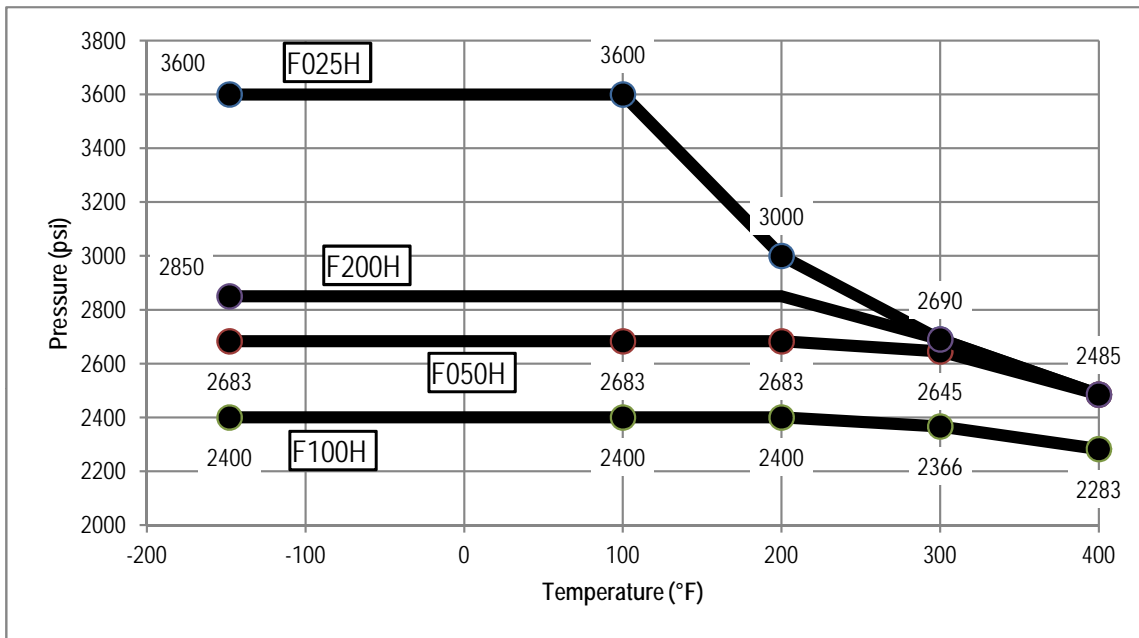

F025A–F100A—ASME B16.5 F316/F316L

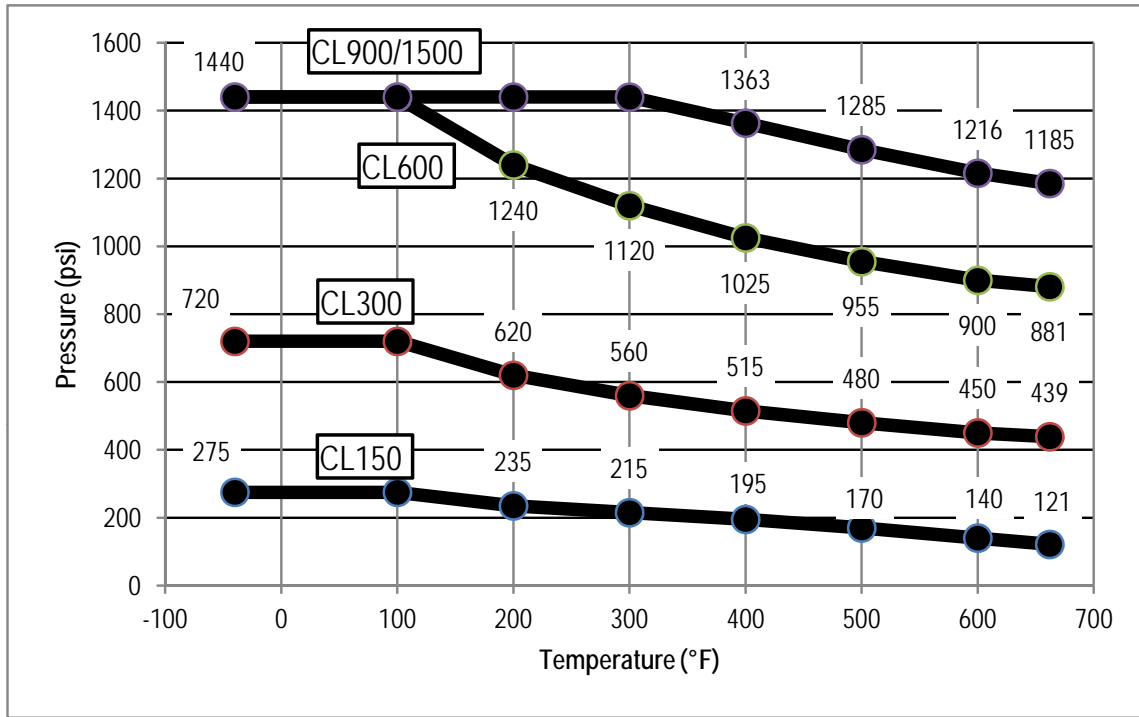

F025B–F100B—ASME B16.5 F304/F304L

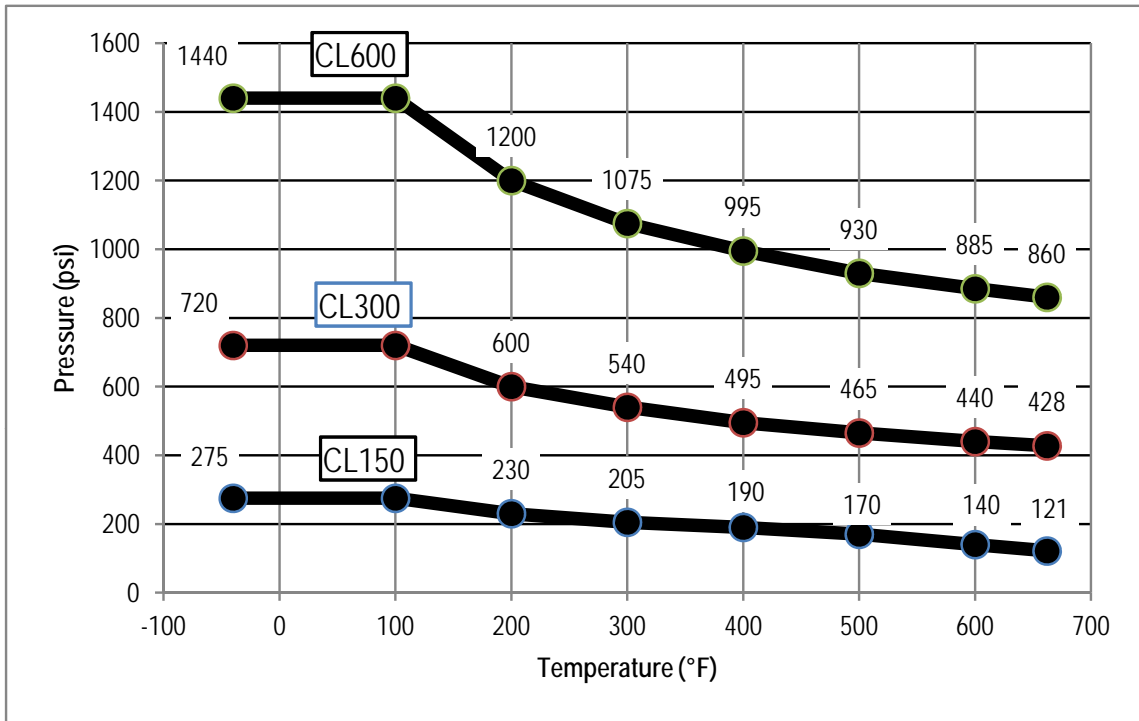

CL900/1500 F025B-F100B - ASME B16.5 F304/F304L

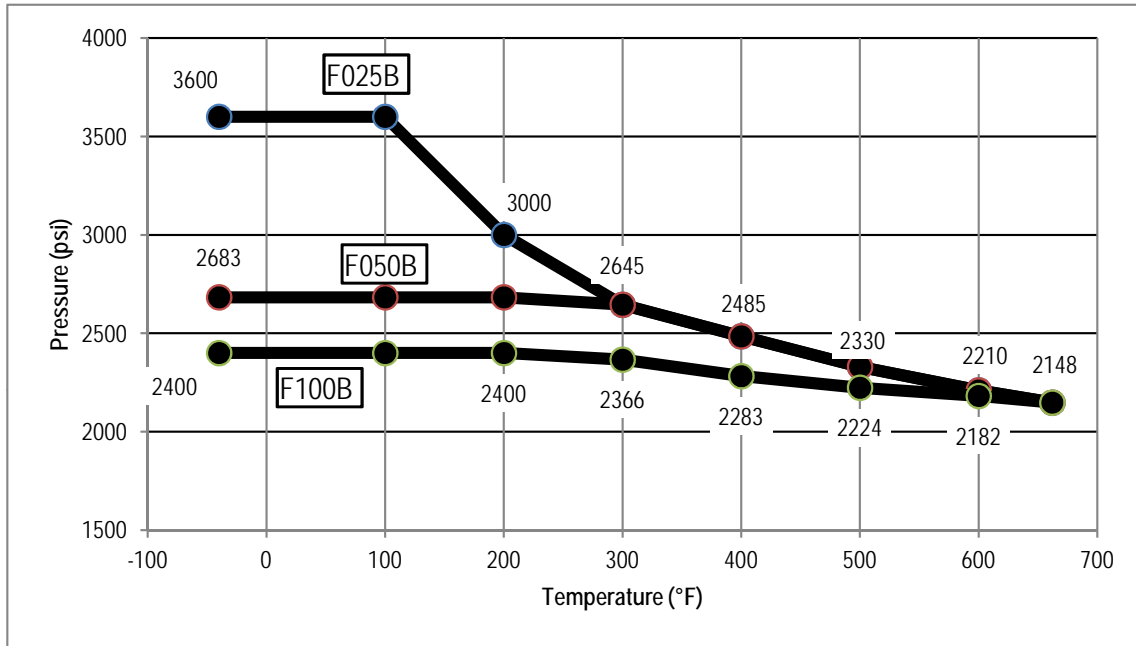

DIN 2635, 2637, 2638 F316/F316L

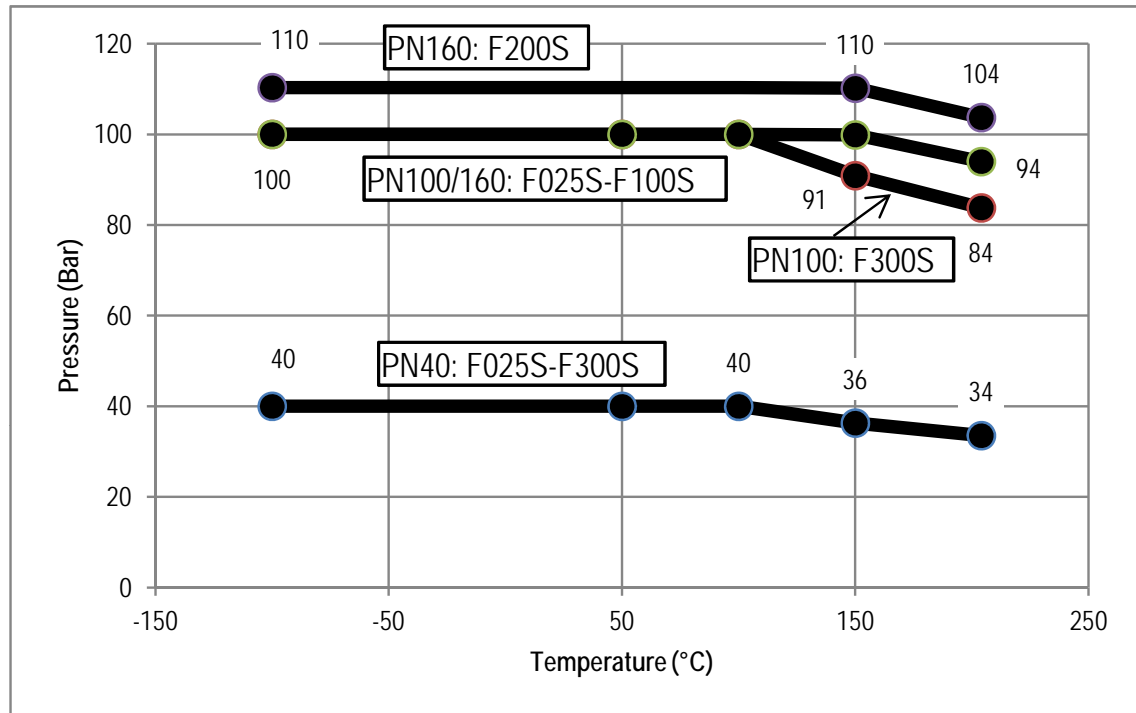

EN 1092-1 F316/F316L and F304/304L

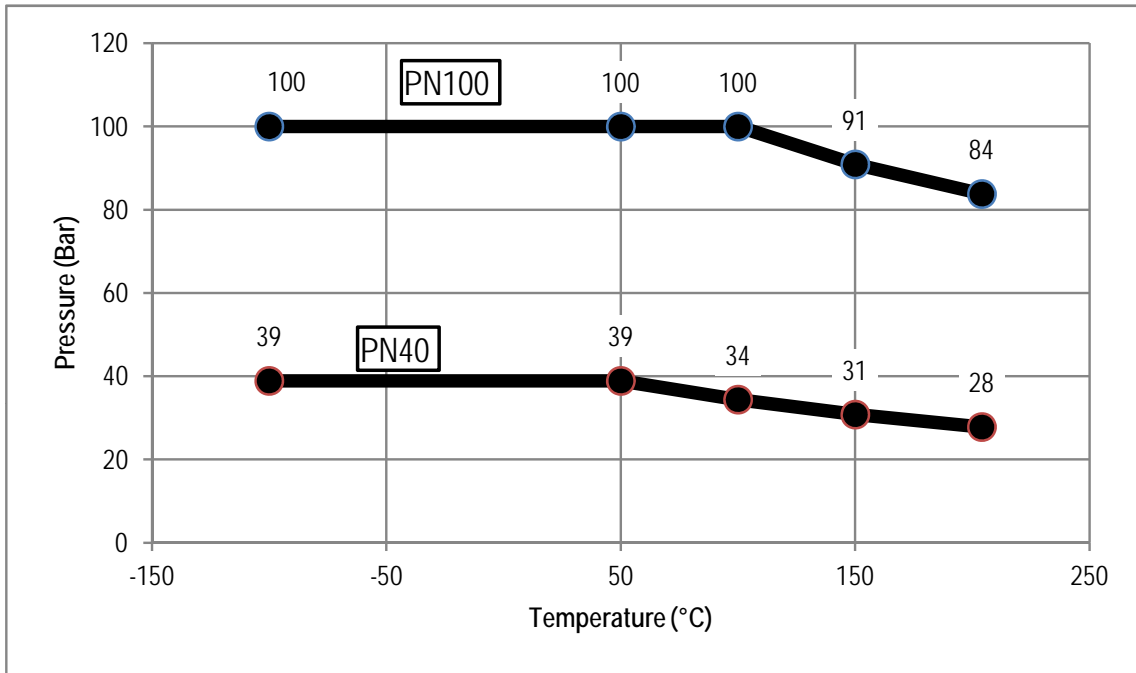

EN 1092-1 F316/F316L and F304/F304L

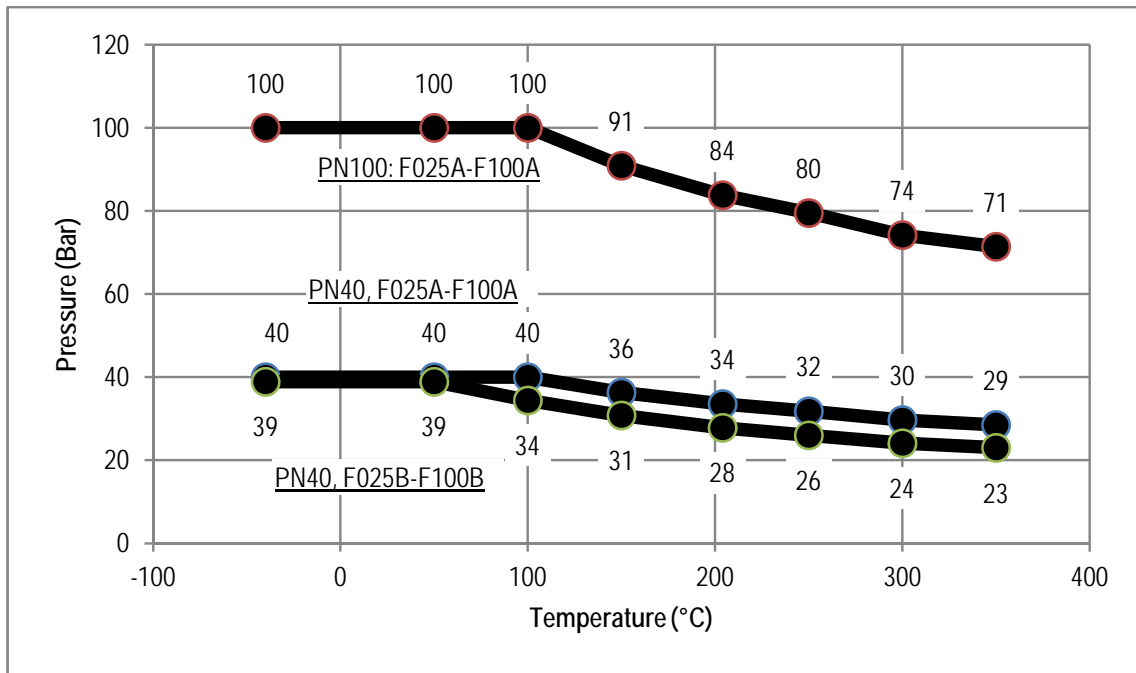

JIS B 2220 F316/316L and F304/304L

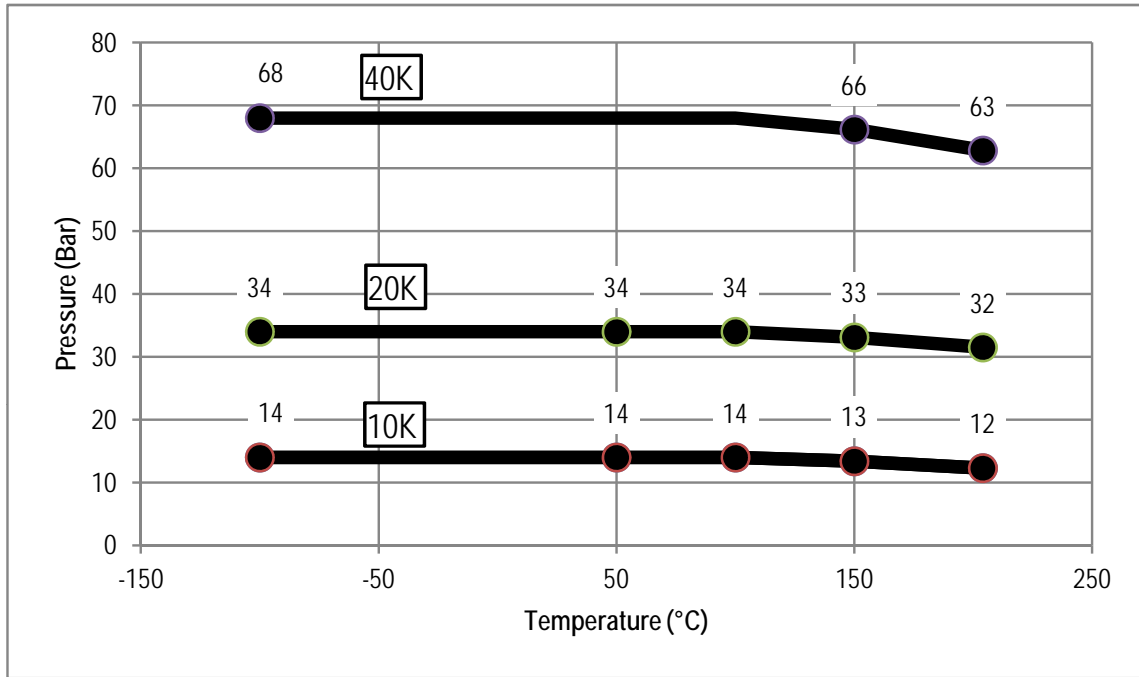

Note

Sensors with JIS process connections do not comply with ASME B31.1 power piping code.

JIS B 2220 F316/F316L and F304F/304L—high temperature

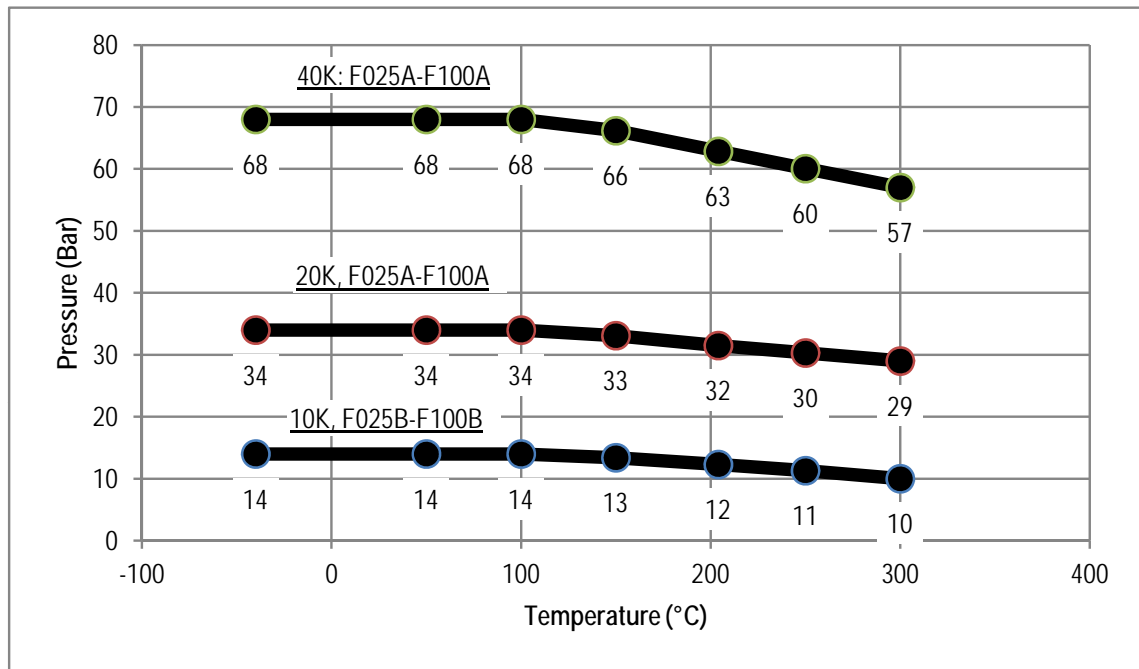

Tri-Clamp compatible 316L and N06022

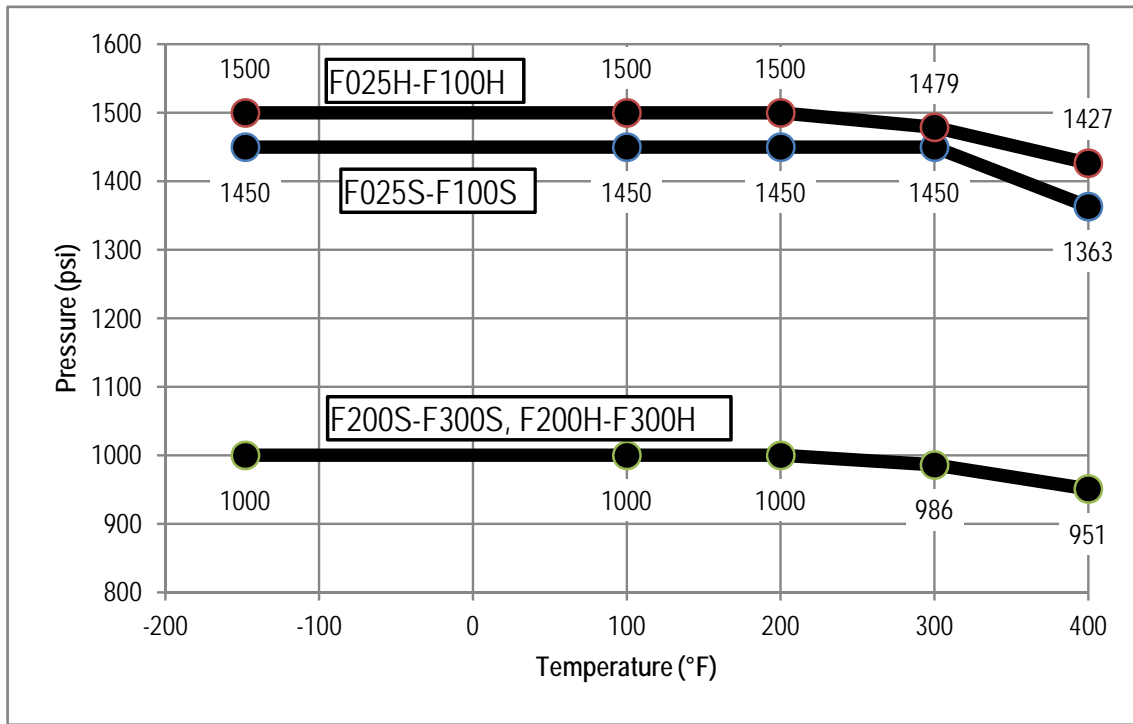

VCO/VCR 316/316L and 3 in (76 mm) grooved coupling 316L

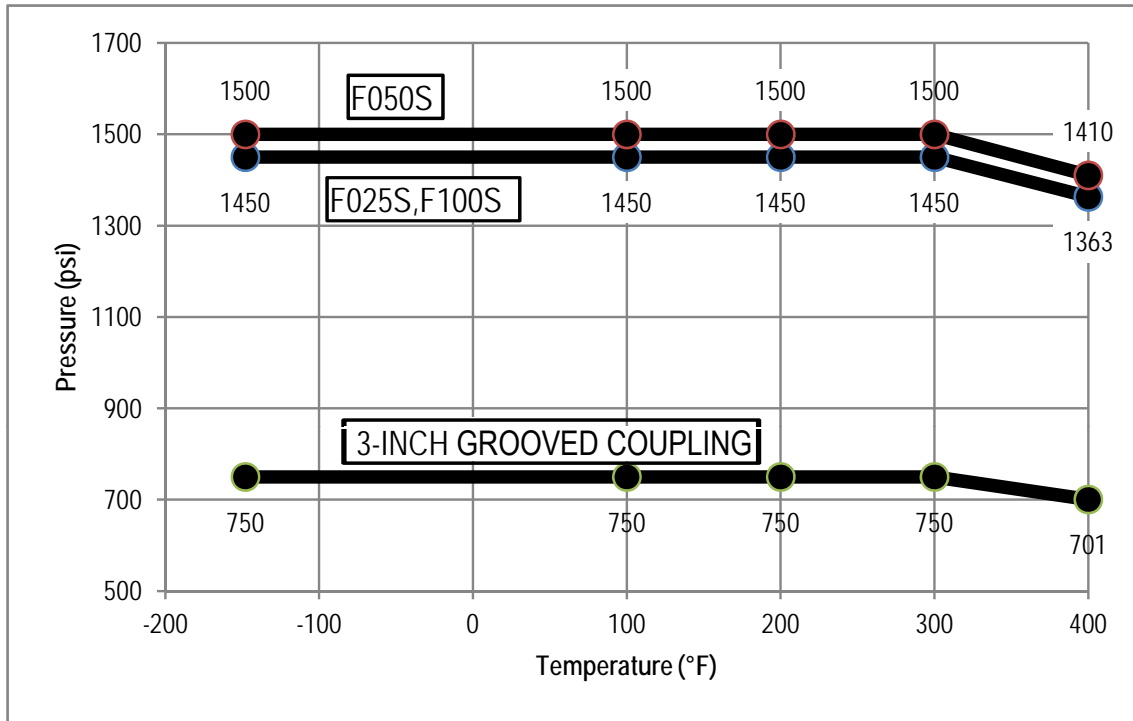

VCO and VCR 316/316L—high pressure

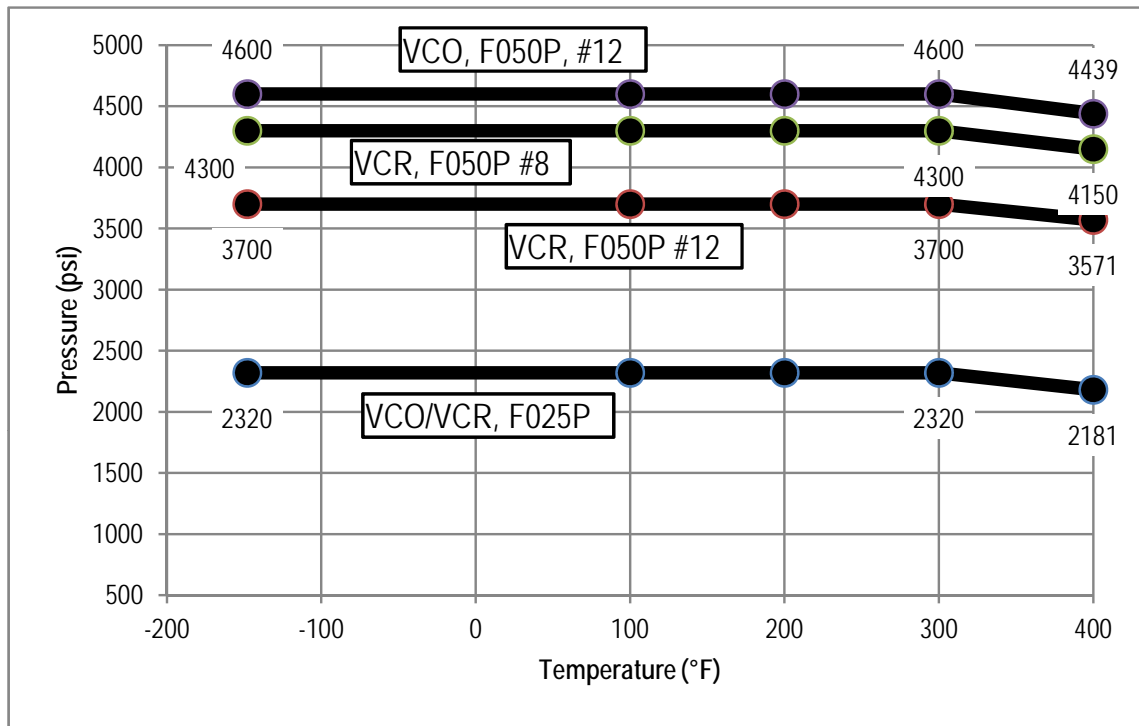

Hazardous area classifications

Detailed classifications

All information and approvals may change depending on sensor/transmitter configurations and operating conditions. Please reference appropriate certificates for exact approvals.

CSA and CSA C-US

Note

Sensor markings shown. For Sensor /Transmitter combination, see the approval certificate.

F025, F050, F100, F200, F300, and F400 with junction box including all high temperature models	Ambient temperature: +140 °F max. (+60 °C max.)
	Class I, Div. 1, Groups C and D; Class I, Div. 2, Groups A, B, C, and D; Class II, Div. 1, Groups E, F, and G
All models with 2400S transmitter including all high temperature models	Ambient temperature: -40 to +140 °F (-40 to +60 °C)
	Class I, Div. 2, Groups A, B, C, and D; Class II, Div. 2, Groups F and G
F025, F050, F100, F200, F300, and F400 with core processor, 2200S, or 1700/2700 transmitter	Ambient temperature: -40 to +140 °F (-40 to +60 °C)
	Class I, Div. 1, Groups C and D; Class I, Div. 2, Groups A, B, C, and D; Class II, Div. 1, Groups E, F, and G
F025, F050, F100, F200, F300, and F400 with 5700 or 4200 transmitter	Ambient temperature: -40 to +149 °F (-40 to +65 °C)
	Class I, Div. 1, Groups C and D; Class I, Div. 2, Groups A, B, C, and D; Class II, Div. 1, Groups E, F, and G
All models with FMT Transmitter	Ambient temperature: -13 to +140 °F (-25 to +60 °C)
	Class I, Div. 2, Groups A, B, C, and D; Class II, Div. 2, Groups F, and G

IECEX

F025, F050, F100, F200, F300, and F400 with core processor or 1700/2700 transmitter, including all high temperature models	Ex ib IIB/IIC T5...T1 Ga/Gb Ex ib IIIC T ⁽¹⁾ °C Db IP66/IP67
F025, F050, F100, F200, F300, and F400 with junction box including all high temperature models	Ex ib IIB/IIC T6...T1 Ga/Gb Ex ib IIIC T ⁽¹⁾ °C Db IP66/IP67
F025, F050, F100, F200, F300, and F400 with 2200S transmitter including all high temperature models	Ex ib IIB/IIC T4...T1 Ga/Gb Ex ib IIIC T °C Db IP66/IP67 or Ex nA IIC T4...T1 Gc EX tc IIIC T ⁽¹⁾ °C Dc
F025, F050, F100, F200, F300, and F400 with 2400 transmitter including all high temperature models	Ex nA IIC T5...T1 Gc Ex tc IIIC T ⁽¹⁾ °C Dc
F025, F050, F100, F200, F300, and F400 with the FMT transmitter	Ex nA IIC T5...T1 Gc Ex tc IIIC T ⁽¹⁾ °C Dc

F025, F050, F100, F200, F300, and F400 with 4200 transmitter including all high temperature models	Ex ib IIB/IIC T6/T4...T1 Ga/Gb Ex ib IIIC T ⁽¹⁾ °C Db IP66/IP67 or Ex nA IIC T6...T1 Gc Ex tc IIIC T ⁽¹⁾ °C Dc
F025, F050, F100, F200, F300, and F400 with 5700 transmitter including all high temperature models	Ex ib IIB/IIC T6...T1 Ga/Gb Ex ib IIIC T ⁽¹⁾ °C Db IP66/IP67 or Ex nA IIC T4...T1 Gc EX tc IIIC T ⁽¹⁾ °C Dc

(1) For ambient and process temperature limits, refer to the appropriate approval certificate.

NEPSI

Note





Sensor markings shown. For Sensor /Transmitter combination, see the approval certificate.









All models with 2400S transmitter	Ex nA IIC T1–T5 Gc
F025, F050, F100, F200, F300, and F400 including all high temperature models with core processor or 1700/2700 transmitter	Ex ib IIB/IIC T1–T5 Ga/Gb
F025, F050, F100, F200, F300, and F400 including all high temperature models with junction box	Ex ib IIB/IIC T1–T6 Ga/Gb
F025, F050, F100, F200, F300, F400 including all high temperature models with 2200 transmitter	Ex ib IIB/IIC T1–T4 Ga/Gb or Ex nA IIC T1-T4 Gc
F025, F050, F100, F200, F300, and F400 with 4200 transmitter including all high temperature models	Ex ib IIB/IIC T1-T4/T6 Ga/Gb or Ex nA IIC T1-T6 Gc
F025, F050, F100, F200, F300, F400 including all high temperature models with 5700 transmitter	Ex ib IIB/IIC T1–T6 Ga/Gb or Ex nA IIC T1-T4 Gc

ATEX

Note

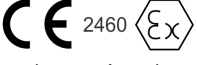
Sensor markings shown. For Sensor /Transmitter combination, see the certificate.

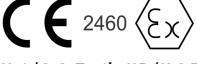
All models with 2400S transmitter including all high temperature models	  II 3G Ex nA IIC T5...T1 Gc II 3D Ex tc IIIC T ⁽¹⁾ °C Dc
F025, F050, F100, F200, F300, F400 including all high temperature models with integral core processor or 1700/2700 transmitter	  II 2G Ex ib IIB/IIC T5...T1 Ga/Gb II 2D Ex ib IIIC T ⁽¹⁾ °C Db IP66/IP67

<p>F025, F050, F100, F200, F300, F400 including all high temperature models with junction box</p>	<p> II 2G Ex ib IIB/IIC T6...T1 Ga/Gb; II 2D Ex ib IIIC T⁽¹⁾ °C Db IP66/IP67</p>
<p>F025, F050, F100, F200, F300, F400 including all high temperature models with 2200S transmitter</p>	<p> II 2G Ex ib IIB/IIC T4...T1 Ga/Gb; II 2D Ex ib IIIC T⁽¹⁾ °C Db IP66/IP67 or  II 3G Ex nA IIC T4...T1 Gc II 3D Ex tc IIIC T⁽¹⁾ °C Dc</p>
<p>F025, F050, F100, F200, F300, F400 with FMT transmitter</p>	<p> II 3G Ex nA IIC T5...T1 Gc II 3D Ex tc IIIC T⁽¹⁾ °C Dc</p>
<p>F025, F050, F100, F200, F300, F400 with 4200 transmitter including all high temperature models</p>	<p> II 1/2G Ex ib IIB/IIC T6/T4...T1 Ga/Gb II 2D Ex ib IIIC T⁽¹⁾ °C Db IP66/IP67 or  II 3G Ex nA IIC T6...T1 Gc II 3D Ex tc IIIC T⁽¹⁾ °C Dc</p>
<p>F025, F050, F100, F200, F300, F400 with 5700 transmitter including all high temperature models</p>	<p> II 1/2G Ex ib IIB/IIC T6...T1 Ga/Gb II 2D Ex ib IIIC T⁽¹⁾ °C Db IP66/IP67 or  II 3G Ex nA IIC T4...T1 Gc II 3D Ex tc IIIC T⁽¹⁾ °C Dc</p>

(1) For ambient and process temperature limits, refer to the appropriate approval certificate.

Process connections

The tables in this section do not represent all possible model and flange combinations. For combinations not listed here, contact a sales representative or the factory.

Dimensions with process connections

Dimension A is provided for each process fitting type when available. The finished face-to-face dimension of the sensor with the process connection ±0.125 in (±3.2 mm) is shown.

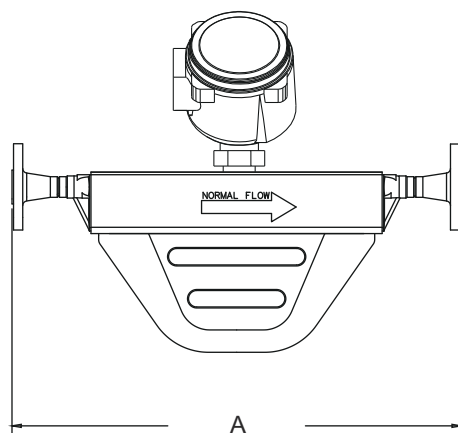

Weight with process connections

Product weights in this section include the weight of the sensor with the process connection and integral core processor, except where noted. Values are rounded to ±1 lb (±0.5 kg). Contact the factory for product shipping weight.

Standard fitting options

F025S

Code	Description						Dim A in (mm)	Weight lb (kg)
113	0.5 in	CL150	ASME B16.5	F316/F316L	Weld neck flange	Raised face	16.0 (406)	14 (6.5)
114	0.5 in	CL300	ASME B16.5	F316/F316L	Weld neck flange	Raised face	16.4 (416)	15 (7)
115	0.5 in	CL600	ASME B16.5	F316/F316L	Weld neck flange	Raised face	16.9 (428)	16 (7)
116	DN15	PN40	DIN 2635	F316/F316L	Weld neck flange	Form C face	15.3 (387)	15 (7)
120	DN15	PN100/ 160	DIN 2638	F316/F316L	Weld neck flange	Form E face	15.8 (401)	17 (8)
121	0.5 in		Tri-Clamp compatible	316L	Hygienic fitting		14.0 (355)	12 (5.5)
122	15mm	20K	JIS B 2220	F316/316L	Weld neck flange	Raised face	15.4 (392)	15 (7)
150	0.5 in	CL900/ 1500	ASME B16.5	F316/316L	Weld neck flange	Raised face	17.5 (445)	18 (8)
170	DN15	PN100/ 160	EN 1092-1	F316/F316L	Weld neck flange	Type B2	15.4 (391)	17 (8)
172	DN25	PN40	EN 1092-1	F316/F316L	Weld neck flange	Type B1	15.3 (387)	17 (8)
176	DN15	PN40	EN 1092-1	F316/F316L	Weld neck flange	Type B1	15.2 (387)	15 (7)

Code	Description						Dim A in (mm)	Weight lb (kg)
178	DN15	PN100	EN 1092-1	F316/F316L	Weld neck flange	Type D	15.4 (391)	17 (7.5)
183	DN25	PN40	EN 1092-1	F316/F316L	Weld neck flange	Type D	13.9 (353)	17 (8)
221	15mm	40K	JIS B 2220	F316/316L	Weld neck flange	Raised face	16.5 (419)	19 (9)
222	DN15		DIN11851	316/316L	Hygienic coupling		15.3 (387)	12 (5.5)
310	DN15	PN40	EN 1092-1	F316/F316L	Weld neck flange	Type D	14.0 (355)	15 (7)
319	#8		VCO	316/316L	Swagelok compatible fitting	0.5 in NPT female adapter	15.8 (401) ⁽¹⁾	12 (5.5)
A94	0.5 in	CL150	ASME B16.5	F316/F316L	Weld neck flange	Raised face 63-125 RA face finish	16.0 (406)	14 (6)
A95	0.5 in	CL300	ASME B16.5	F316/F316L	Weld neck flange	Raised face 63-125 RA face finish	16.4 (416)	16 (7)
A96	0.5 in	CL600	ASME B16.5	F316/F316L	Weld neck flange	Raised face 63-125 RA face finish	16.9 (429)	14 (6)
A97	0.5 in	CL900/ 1500	ASME B16.5	F316/F316L	Weld neck flange	Raised face 63-125 RA face finish	17.5 (445)	21 (10)
A99	0.75 in	CL150	ASME B16.5	F316/F316L	Weld neck flange	Raised face	16.0 (406)	14 (6)
B01	0.75 in	CL300	ASME B16.5	F316/F316L	Weld neck flange	Raised face	16.5 (419)	18 (8)
B02	0.75 in	CL600	ASME B16.5	F316/F316L	Weld neck flange	Raised face	17.3 (438)	18 (8)
B03	0.75 in	CL900/ 1500	ASME B16.5	F316/F316L	Weld neck flange	Raised face	18.3 (464)	23 (10)
B04	1 in	CL150	ASME B16.5	F316/F316L	Weld neck flange	Raised face	16.3 (413)	16 (7)
B05	1 in	CL300	ASME B16.5	F316/F316L	Weld neck flange	Raised face	16.6 (422)	19 (9)
B06	1 in	CL600	ASME B16.5	F316/F316L	Weld neck flange	Raised face	17.1 (435)	20 (9)
B07	1 in	CL900/ 1500	ASME B16.5	F316/F316L	Weld neck flange	Raised face	18.0 (457)	28 (13)
B09	0.5 in	CL300	ASME B16.5	F316/F316L	Weld neck flange	RTJ face	16.8 (427)	16 (7)
B10	0.5 in	CL600	ASME B16.5	F316/F316L	Weld neck flange	RTJ face	16.8 (427)	16 (7)

Code	Description						Dim A in (mm)	Weight lb (kg)
B11	0.5 in	CL900/1500	ASME B16.5	F316/F316L	Weld neck flange	RTJ face	17.5 (445)	21 (10)
B77	#8	[blank]	VCR	F316/F316L	Swagelok compatible fitting	Swagelok compatible fitting	17.2 (437)	13 (6)
B78	#12	[blank]	VCR	F316/F316L	Swagelok compatible fitting	0.75 in 316 NPT female adapter	15.4 (391)	14 (6)
C73	DN15	PN40	EN 1092-1	F316/F316L	Weld neck flange	Type F	15.3 (387)	15 (7)

(1) Dimension specified in table does NOT include fitting length. For installation, modify Dim. A value to include fitting.

F025A

Code	Description						Dim A in (mm)	Weight lb (kg) ⁽¹⁾
113	0.5 in	CL150	ASME B16.5	F316/F316L	Weld neck flange	Raised face	16.0 (406)	12 (5.5)
114	0.5 in	CL300	ASME B16.5	F316/F316L	Weld neck flange	Raised face	16.4 (416)	13 (6)
115	0.5 in	CL600	ASME B16.5	F316/F316L	Weld neck flange	Raised face	16.9 (428)	13 (6)
122	15mm	20K	JIS B 2220	F316/F316L	Weld neck flange	Raised face	15.4 (392)	13 (6)
150	0.5 in	CL900/1500	ASME B16.5	F316/F316L	Weld neck flange	Raised face	17.5 (444)	15 (7)
170	DN15	PN100/160	EN 1092-1	F316/F316L	Weld neck flange	Type B2	15.8 (401)	15 (7)
172	DN25	PN40	EN 1092-1	F316/F316L	Weld neck flange	Type B1	15.4 (391)	15 (7)
176	DN15	PN40	EN 1092-1	F316/F316L	Weld neck flange	Type B1	15.3 (387)	13 (6)
178	DN15	PN100	EN 1092-1	F316/F316L	Weld neck flange	Type D	15.8 (401)	15 (7)
183	DN25	PN40	EN 1092-1	F316/F316L	Weld neck flange	Type D	15.4 (391)	15 (7)
310	DN15	PN40	EN 1092-1	F316/F316L	Weld neck flange	Raised face	15.3 (387)	13 (6)

(1) Weight shown includes the sensor, process fitting, and painted aluminum junction box, no electronics or transmitter.

F025P

Code	Description						Dim A in (mm)	Weight lb (kg)
120	DN15	PN100/ 160	DIN 2638	F316/F316L	Weld neck flange	Form E face	15.8 (401)	17 (8)
150	0.5 in	CL900/ 1500	ASME B16.5	F316/F316L	Weld neck flange	Raised face	17.5 (444)	17 (8)
170	DN15	PN100/ 160	EN 1092-1	F316/F316L	Weld neck flange	Type B2	15.8 (401)	17 (8)
178	DN15	PN100	EN 1092-1	F316/F316L	Weld neck flange	Type D	15.8 (401)	17 (7.5)
180	DN25	PN100	EN 1092-1	F316/F316L	Weld neck flange	Type B2	16.8 (427)	24 (10.5)
319	#8		VCO	316/316L	Swagelok compatible fitting	0.5 in NPT female adapter	14.0 (355) ⁽¹⁾	12 (5.5)

(1) Dimension specified in table does NOT include fitting length. For installation, modify Dim. A value to include fitting.

F025B

Code	Description						Dim A in (mm)	Weight ⁽¹⁾ lb (kg)
517	0.5 in	CL600	ASME B16.5	F304/F304L	Lap joint flange	N06022 stub	16.4 (417)	13 (6)
520	0.5 in	CL150	ASME B16.5	F304/F304L	Lap joint flange	N06022 stub	16.1 (408)	17 (8)
521	0.5 in	CL300	ASME B16.5	F304/F304L	Lap joint flange	N06022 stub	16.4 (417)	18 (8)
522	15mm	10K	JIS B 2220	F304/F304L	Lap joint flange	N06022 stub	15.5 (394)	13 (6)
524	DN15	PN40	EN 1092-1	F304/F304L	Lap joint flange	Type B1, N06022 stub	15.3 (388)	13 (6)

(1) Weight shown includes the sensor, process fitting, and painted aluminum junction box, no electronics or transmitter.

F025H

Code	Description						Dim A in (mm)	Weight lb (kg)
517	0.5 in	CL600	ASME B16.5	F304/F304L	Lap joint flange	N06022 stub	16.4 (417)	15 (7)
520	0.5 in	CL150	ASME B16.5	F304/F304L	Lap joint flange	N06022 stub	16.1 (408)	19 (9)
521	0.5 in	CL300	ASME B16.5	F304/F304L	Lap joint flange	N06022 stub	16.4 (417)	20 (9)
522	15mm	10K	JIS B 2220	F304/F304L	Lap joint flange	N06022 stub	15.5 (394)	15 (7)
524	DN15	PN40	EN 1092-1	F304/F304L	Lap joint flange	Type B1, N06022 stub	15.3 (388)	15 (7)

F050S

Code	Description						Dim A in (mm)	Weight lb (kg)
113	0.5 in	CL150	ASME B16.5	F316/F316L	Weld neck flange	Raised face	18.1 (460)	15 (7)
114	0.5 in	CL300	ASME B16.5	F316/F316L	Weld neck flange	Raised face	18.5 (469)	16 (7.5)
115	0.5 in	CL600	ASME B16.5	F316/F316L	Weld neck flange	Raised face	19.0 (482)	17 (7.5)
116	DN15	PN40	DIN 2635	F316/F316L	Weld neck flange	Form C face	17.4 (441)	16 (7.5)
120	DN15	PN100/ 160	DIN 2638	F316/F316L	Weld neck flange	Form E face	17.9 (455)	18 (8.5)
122	15mm	20K	JIS B 2220	F316/316L	Weld neck flange	Raised face	17.6 (446)	18 (8)
131	DN25	PN40	DIN 2635	F316/F316L	Weld neck flange	Form C face	17.5 (444)	18 (8.5)
150	0.5 in	CL900/1 500	ASME B16.5	F316/F316L	Weld neck flange	Type F	19.7 (498)	18 (8.5)
170	DN15	PN100/ 160	EN 1092-1	F316/F316L	Weld neck flange	Type B2	17.9 (455)	18 (8.5)
172	DN25	PN40	EN 1092-1	F316/F316L	Weld neck flange	Type B1	17.5 (445)	18 (8.5)
176	DN15	PN40	EN 1092-1	F316/F316L	Weld neck flange	Type B1	17.4 (441)	16 (7.5)
178	DN15	PN100	EN 1092-1	F316/F316L	Weld neck flange	Type D	17.9 (455)	18 (8)
183	DN25	PN40	EN 1092-1	F316/F316L	Weld neck flange	Type D	17.5 (445)	18 (8.5)
221	15mm	40K	JIS B 2220	F316/316L	Weld neck flange	Raised face	18.6 (473)	19 (9)
222	DN15		DIN11851	316/316L	Hygienic coupling		16.0 (407)	13 (6)
239	#12		VCO	316/316L	Swagelok compatible fitting	0.75 in NPT female adapter	16.4 (415)	14 (6)
310	DN15	PN40	EN 1092-1	F316/F316L	Weld neck flange	Type D	17.4 (441)	16 (7.5)
322	0.75 in		Tri-Clamp compatible	316L	Hygienic fitting		15.9 (403)	13 (6)
A94	0.5 in	CL150	ASME B16.5	F316/F316L	Weld neck flange	Raised face 63-125 RA face finish	18.1 (460)	16 (7)
A95	0.5 in	CL300	ASME B16.5	F316/F316L	Weld neck flange	Raised face 63-125 RA face finish	18.5 (470)	17 (8)

Code	Description						Dim A in (mm)	Weight lb (kg)
A96	0.5 in	CL600	ASME B16.5	F316/F316L	Weld neck flange	Raised face 63-125 RA face finish	19.0 (483)	17 (8)
A97	0.5 in	CL900/1 500	ASME B16.5	F316/F316L	Weld neck flange	Raised face 63-125 RA face finish	19.6 (498)	22 (10)
A99	0.75 in	CL150	ASME B16.5	F316/F316L	Weld neck flange	Raised face	18.3 (464)	16 (7)
B01	0.75 in	CL300	ASME B16.5	F316/F316L	Weld neck flange	Raised face	18.6 (473)	19 (9)
B02	0.75 in	CL600	ASME B16.5	F316/F316L	Weld neck flange	Raised face	19.4 (492)	19 (9)
B03	0.75 in	CL900/1 500	ASME B16.5	F316/F316L	Weld neck flange	Raised face	20.4 (517)	25 (11)
B04	1 in	CL150	ASME B16.5	F316/F316L	Weld neck flange	Raised face	18.4 (467)	17 (8)
B05	1 in	CL300	ASME B16.5	F316/F316L	Weld neck flange	Raised face	18.8 (476)	20 (9)
B06	1 in	CL600	ASME B16.5	F316/F316L	Weld neck flange	Raised face	19.3 (489)	21 (10)
B07	1 in	CL900/1 500	ASME B16.5	F316/F316L	Weld neck flange	Raised face	20.1 (511)	29 (13)
B09	0.5 in	CL300	ASME B16.5	F316/F316L	Weld neck flange	RTJ face	18.9 (481)	17 (8)
B10	0.5 in	CL600	ASME B16.5	F316/F316L	Weld neck flange	RTJ face	18.9 (481)	17 (8)
B11	0.5 in	CL900/1 500	ASME B16.5	F316/F316L	Weld neck flange	RTJ face	19.6 (498)	22 (10)
B77	#8	[blank]	VCR	F316/F316L	Swagelok compatible fitting	0.75 in 316 female adapter	19.3 (489)	14 (6)
B78	#12	[blank]	VCR	F316/F316L	Swagelok compatible fitting	0.75 in 316 female adapter	17.5(44 5)	15 (7)
C73	DN15	PN40	EN 1092-1	F316/F316L	Weld neck flange	Type F	17.4 (441)	17 (8)

F050A

Code	Description						Dim A in (mm)	Weight (¹) lb (kg)
113	0.5 in	CL150	ASME B16.5	F316/F316L	Weld neck flange	Raised face	18.1 (460)	13 (6)
114	0.5 in	CL300	ASME B16.5	F316/F316L	Weld neck flange	Raised face	18.5 (469)	14 (6.5)
115	0.5 in	CL600	ASME B16.5	F316/F316L	Weld neck flange	Raised face	19.0 (482)	15 (6.5)
122	15mm	20K	JIS B 2220	F316/F316L	Weld neck flange	Raised face	17.6 (446)	14 (6.5)
150	0.5 in	CL900/ 1500	ASME B16.5	F316/F316L	Weld neck flange	Raised face	19.6 (498)	16 (7.5)
170	DN15	PN100/ 160	EN 1092-1	F316/F316L	Weld neck flange	Type B2	17.9 (455)	16 (7.5)
172	DN25	PN40	EN 1092-1	F316/F316L	Weld neck flange	Type B1	17.5 (445)	16 (7.5)
176	DN15	PN40	EN 1092-1	F316/F316L	Weld neck flange	Type B1	17.4 (441)	14 (6.5)
178	DN15	PN100	EN 1092-1	F316/F316L	Weld neck flange	Type D	17.9 (455)	16 (7)
183	DN25	PN40	EN 1092-1	F316/F316L	Weld neck flange	Type D	17.5 (445)	16 (7.5)
221	15mm	40K	JIS B 2220	F316/316L	Weld neck flange	Raised face	18.6 (473)	22 (10)
310	DN15	PN40	EN 1092-1	F316/F316L	Weld neck flange	Type D	17.4 (441)	14 (6.5)

(1) Weight shown includes the sensor, process fitting, and painted aluminum junction box, no electronics or transmitter.

F050P

Code	Description						Dim A in (mm)	Weight lb (kg)
113	0.5 in	CL150	ASME B16.5	F316/F316L	Weld neck flange	Raised face	18.1 (460)	15 (7)
114	0.5 in	CL300	ASME B16.5	F316/F316L	Weld neck flange	Raised face	18.5 (469)	16 (7.5)
115	0.5 in	CL600	ASME B16.5	F316/F316L	Weld neck flange	Raised face	19.0 (482)	17 (7.5)
116	DN15	PN40	DIN 2635	F316/F316L	Weld neck flange	Form C face	17.4 (441)	16 (7.5)
120	DN15	PN100/ 160	DIN 2638	F316/F316L	Weld neck flange	Form E face	17.9 (455)	18 (8.5)
122	15mm	20K	JIS B 2220	F316/F316L	Weld neck flange	Raised face	17.6 (446)	16 (7.5)

Code	Description						Dim A in (mm)	Weight lb (kg)
131	DN25	PN40	DIN 2635	F316/F316L	Weld neck flange	Form C face	17.5 (444)	18 (8.5)
150	0.5 in	CL900/ 1500	ASME B16.5	F316/F316L	Weld neck flange	Raised face	19.6 (498)	18 (8.5)
170	DN15	PN100/ 160	EN 1092-1	F316/F316L	Weld neck flange	Type B2	17.9 (455)	18 (8.5)
178	DN15	PN100	EN 1092-1	F316/F316L	Weld neck flange	Type D	17.9 (455)	18 (8)
180	DN25	PN100	EN 1092-1	F316/F316L	Weld neck flange	Type B2	18.9 (481)	25 (11)
222	DN15		DIN11851	316/316L	Hygienic coupling		16.0 (407)	13 (6)
239	#12		VCO	316/316L	Swagelok compatible fitting	0.75 in NPT female adapter	16.4 (415) ⁽¹⁾	14 (6)
322	0.75 in		Tri-Clamp compatible	316L	Hygienic fitting		15.9 (403)	13 (6)

(1) Dimension specified in table does NOT include fitting length. For installation, modify Dim. A value to include fitting.

F050B

Code	Description						Dim A in (mm)	Weight ⁽¹⁾ lb (kg)
517	0.5 in	CL600	ASME B16.5	F304/F304L	Lap joint flange	N06022 stub	18.6 (471)	14 (6.5)
520	0.5 in	CL150	ASME B16.5	F304/F304L	Lap joint flange	N06022 stub	18.2 (462)	18 (8.5)
521	0.5 in	CL300	ASME B16.5	F304/F304L	Lap joint flange	N06022 stub	18.6 (471)	19 (8.5)
522	15mm	10K	JIS B 2220	F304/F304L	Lap joint flange	N06022 stub	17.6 (447)	14 (6.5)
524	DN15	PN40	EN 1092-1	F304/F304L	Lap joint flange	Type B1, N06022 stub	17.4 (442)	14 (6.5)

(1) Weight shown includes the sensor, process fitting, and painted aluminum junction box, no electronics or transmitter.

F050H

Code	Description						Dim A in (mm)	Weight lb (kg)
517	0.5 in	CL600	ASME B16.5	F304/F304L	Lap joint flange	N06022 stub	18.6 (471)	17 (7.5)
520	0.5 in	CL150	ASME B16.5	F304/F304L	Lap joint flange	N06022 stub	18.2 (462)	20 (9.5)
521	0.5 in	CL300	ASME B16.5	F304/F304L	Lap joint flange	N06022 stub	18.6 (471)	21 (9.5)

Code	Description						Dim A in (mm)	Weight lb (kg)
522	15mm	10K	JIS B 2220	F304/F304L	Lap joint flange	N06022 stub	17.6 (447)	16 (7.5)
524	DN15	PN40	EN 1092-1	F304/F304L	Lap joint flange	Type B1, N06022 stub	17.4 (442)	17 (7.5)

F100S

Code	Description						Dim A in (mm)	Weight lb (kg)
128	1in	CL150	ASME B16.5	F316/F316L	Weld neck flange	Raised face	22.7 (576)	24 (11)
129	1in	CL300	ASME B16.5	F316/F316L	Weld neck flange	Raised face	23.2 (588)	27 (12)
130	1in	CL600	ASME B16.5	F316/F316L	Weld neck flange	Raised face	23.7 (601)	27 (12.5)
131	DN25	PN40	DIN 2635	F316/F316L	Weld neck flange	Form C face	21.4 (544)	25 (11.5)
137	DN25	PN100/160	DIN 2638	F316/F316L	Weld neck flange	Form E face	22.8 (580)	31 (14)
179	DN25	PN40	EN 1092-1	F316/F316L	Weld neck flange	Type B1	21.4 (544)	25 (11.5)
180	DN25	PN100	EN 1092-1	F316/F316L	Weld neck flange	Type B2	22.9 (580)	31 (14)
181	DN25	PN100	EN 1092-1	F316/F316L	Weld neck flange	Type D	22.9 (580)	31 (14)
209	2 in	CL150	ASME B16.5	F316/F316L	Weld neck flange	Raised face	23.1 (585)	32 (14.5)
229	25mm	40K	JIS B 2220	F316/316L	Weld neck flange	Raised face	22.9 (582)	31 (14)
230	DN25		DIN11851	316/316L	Hygienic coupling		20.6 (522)	20 (9)
311	DN25	PN40	EN 1092-1	F316/F316L	Weld neck flange	Type D	21.4 (544)	25 (11.5)
928	1 in	CL900/1500	ASME B16.5	F316/F316L	Weld neck flange	Raised face	24.6 (624)	36 (16)
B14	1 in	CL150	ASME B16.5	F316/F316L	Weld neck flange	Raised face 63-125 Ra face finish	22.7 (576)	24 (11)
B15	1in	CL300	ASME B16.5	F316/F316L	Weld neck flange	Raised face 63-125 Ra face finish	23.2 (589)	27 (12)
B16	1in	CL600	ASME B16.5	F316/F316L	Weld neck flange	Raised face 63-125 Ra face finish	23.7 (602)	28 (13)

Code	Description						Dim A in (mm)	Weight lb (kg)
B17	1.5 in	CL150	ASME B16.5	F316/F316L	Weld neck flange	Raised face	22.9 (583)	27 (12)
B18	1.5 in	CL300	ASME B16.5	F316/F316L	Weld neck flange	Raised face	23.4 (594)	32 (15)
B19	1.5 in	CL600	ASME B16.5	F316/F316L	Weld neck flange	Raised face	24.3 (616)	35 (16)
B20	1.5 in	CL900/1500	ASME B16.5	F316/F316L	Weld neck flange	Raised face	24.8 (630)	46 (21)
B21	1.5 in	CL900/1500	ASME B16.5	F316/F316L	Weld neck flange	Raised face	23.6 (598)	34 (15)
B22	1.5 in	CL900/1500	ASME B16.5	F316/F316L	Weld neck flange	Raised face	24.3 (616)	38 (17)
B23	1.5 in	CL900/1500	ASME B16.5	F316/F316L	Weld neck flange	Raised face	26.8 (679)	65 (29)
B24	1 in	CL300	ASME B16.5	F316/F316L	Weld neck flange	RTJ face	23.7 (602)	27 (12)
B25	1 in	CL600	ASME B16.5	F316/F316L	Weld neck flange	RTJ face	23.7 (602)	28 (13)
B26	1.5 in	CL900/1500	ASME B16.5	F316/F316L	Weld neck flange	RTJ face	23.5 (641)	46 (21)
B81	#16	[blank]	VCO	F316/F316L	Swagelok compatible fitting	1 in 316 NPT female adapter	20.3 (514)	22 (10)
B82	#16	[blank]	VCR	F316/F316L	Swagelok compatible fitting	1 in 316 NPT female adapter	23.5 (641)	23 (10)
C74	DN25	PN40	EN 1092-1	F316/F316L	Weld neck flange	Type F	21.4 (545)	25 (11)

F100A

Code	Description						Dim A in (mm)	Weight (¹) lb (kg)
128	1in	CL150	ASME B16.5	F316/F316L	Weld neck flange	Raised face	22.7 (576)	22 (10)
129	1in	CL300	ASME B16.5	F316/F316L	Weld neck flange	Raised face	23.2 (588)	32 (14.5)
130	1in	CL600	ASME B16.5	F316/F316L	Weld neck flange	Raised face	23.7 (601)	25 (11.5)
139	25mm	20K	JIS B 2220	F316/F316L	Weld neck flange	Raised face	21.7 (550)	23 (10.5)
179	DN25	PN40	EN 1092-1	F316/F316L	Weld neck flange	Type B1	21.4 (544)	23 (10.5)

Code	Description						Dim A in (mm)	Weight (¹) lb (kg)
209	2 in	CL150	ASME B16.5	F316/F316L	Weld neck flange	Raised face	23.1 (585)	30 (13.5)
229	25mm	40K	JIS B 2220	F316/316L	Weld neck flange	Raised face	22.9 (582)	31 (14)
311	DN25	PN40	EN 1092-1	F316/F316L	Weld neck flange	Type D	21.4 (544)	23 (10.5)
928	1in	CL900	ASME B16.5	F316/F316L	Weld neck flange	Raised face	24.6 (623)	34 (15.5)

(1) Weight shown includes the sensor, process fitting, and painted aluminum junction box, no electronics or transmitter.

F100B

Code	Description						Dim A in (mm)	Weight (¹) lb (kg)
530	1in	CL150	ASME B16.5	F304/F304L	Lap joint flange	N06022 stub	22.7 (577)	24 (10.5)
531	1in	CL300	ASME B16.5	F304/F304L	Lap joint flange	N06022 stub	23.2 (590)	26 (12)
532	25mm	10K	JIS B 2220	F304/F304L	Lap joint flange	N06022 stub	21.8 (552)	25 (11)
534	DN25	PN40	EN 1092-1	F304/F304L	Lap joint flange	Type B1, N06022 stub	21.5 (546)	25 (11)
535	1in	CL600	ASME B16.5	F304/F304L	Lap joint flange	N06022 stub	23.2 (590)	26 (12)

(1) Weight shown includes the sensor, process fitting, and painted aluminum junction box, no electronics or transmitter.

F100H

Code	Description						Dim A in (mm)	Weight lb (kg)
530	1in	CL150	ASME B16.5	F304/F304L	Lap joint flange	N06022 stub	22.7 (577)	26 (11.5)
531	1in	CL300	ASME B16.5	F304/F304L	Lap joint flange	N06022 stub	23.2 (590)	28 (13)
532	25mm	10K	JIS B 2220	F304/F304L	Lap joint flange	N06022 stub	21.8 (552)	27 (12)
534	DN25	PN40	EN 1092-1	F304/F304L	Lap joint flange	Type B1, N06022 stub	21.5 (546)	27 (12)
535	1in	CL600	ASME B16.5	F304/F304L	Lap joint flange	N06022 stub	23.2 (590)	28 (13)

F100P

Code	Description						Dim A in (mm)	Weight lb (kg)
C55	1in	CL2500	ASME B16.5	Nickel alloy C22	Weld neck flange	RTJ	25.8 (655)	46 (21)
C56	1.5 in	CL2500	ASME B16.5	Nickel alloy C22	Weld neck flange	RTJ	27.6 (701)	76 (34.5)
C57	1in	CL2500 (360 bar)	ASME B16.5	F316/F316L	Weld neck flange	RTJ	25.8 (655)	44 (20)
C58	1.5 in	CL2500(360 bar)	ASME B16.5	F316/F316L	Weld neck flange	RTJ	27.6 (701)	71 (32)
C64	1in	CL2500	ASME B16.5	F316/F316L	Weld neck flange	RTJ	25.8 (655)	44 (20)
C65	1.5 in	CL2500	ASME B16.5	F316/F316L	Weld neck flange	RTJ	27.6 (701)	71 (32)

F200S

Code	Description						Dim A in (mm)	Weight lb (kg)
312	DN40	PN40	EN 1092-1	F316/F316L	Weld neck flange	Type D	23.4 (595)	48 (21.5)
316	DN50	PN40	EN 1092-1	F316/F316L	Weld neck flange	Type D	23.7 (601)	51 (23)
341	1.5 in	CL150	ASME B16.5	F316/F316L	Weld neck flange	Raised face	24.8 (629)	46 (21)
342	1.5 in	CL300	ASME B16.5	F316/F316L	Weld neck flange	Raised face	25.3 (642)	52 (23.5)
343	1.5 in	CL600	ASME B16.5	F316/F316L	Weld neck flange	Raised face	25.8 (654)	55 (25)
351	1.5 in		Tri-Clamp compatible	316L	Hygienic fitting		23.3 (591)	39 (17.5)
352	2 in		Tri-Clamp compatible	316L	Hygienic fitting		22.9 (581)	39 (18)
353	DN40		DIN11851	316/316L	Hygienic coupling		23.2 (589)	46 (21)
363	DN40	PN100	EN 1092-1	F316/F316L	Weld neck flange	Type B2	24.8 (629)	56 (25.5)
365	DN50	PN100	EN 1092-1	F316/F316L	Weld neck flange	Type B2	25.3 (641)	64 (29)
366	DN40	PN100	EN 1092-1	F316/F316L	Weld neck flange	Type D	24.8 (629)	56 (25.5)
367	DN50	PN100	EN 1092-1	F316/F316L	Weld neck flange	Type D	25.3 (641)	64 (29)

Code	Description						Dim A in (mm)	Weight lb (kg)
368	DN40	PN40	EN 1092-1	F316/F316L	Weld neck flange	Type B1	23.4 (595)	48 (21.5)
369	DN50	PN40	EN 1092-1	F316/F316L	Weld neck flange	Type B1	23.7 (601)	51 (23)
378	DN50	PN100	DIN 2637	F316/F316L	Weld neck flange	Form E face	25.4 (646)	64 (29)
381	DN40	PN40	DIN 2635	F316/F316L	Weld neck flange	Form C face	23.6 (599)	48 (21.5)
382	DN50	PN40	DIN 2635	F316/F316L	Weld neck flange	Form C face	23.8 (605)	51 (23)
385	40mm	10K	JIS B 2220	F316/F316L	Weld neck flange	Raised face	23.4 (595)	46 (21)
386	50mm	10K	JIS B 2220	F316/316L	Weld neck flange	Raised face	23.7 (602)	48 (22)
387	40mm	20K	JIS B 2220	F316/F316L	Weld neck flange	Raised face	23.4 (595)	47 (21)
388	50mm	20K	JIS B 2220	F316/316L	Weld neck flange	Raised face	23.7 (602)	48 (22)
418	2 in	CL150	ASME B16.5	F316/F316L	Weld neck flange	Raised face	24.9 (632)	50 (22.5)
419	2 in	CL300	ASME B16.5	F316/F316L	Weld neck flange	Raised face	25.4 (645)	54 (24.5)
420	2 in	CL600	ASME B16.5	F316/F316L	Weld neck flange	Raised face	26.1 (664)	58 (26)
A31	1.5 in	CL900/1 500	ASME B16.5	F316/F316L	Weld neck flange	Raised face	26.9 (683)	65 (29)
A32	1.5 in	CL150	ASME B16.5	F316/F316L	Weld neck flange	Raised face 63-125 Ra face finish	24.8 (629)	46 (21)
A33	1.5 in	CL300	ASME B16.5	F316/F316L	Weld neck flange	Raised face 63-125 Ra face finish	25.3 (641)	52 (24)
A34	1.5 in	CL600	ASME B16.5	F316/F316L	Weld neck flange	Raised face 63-125 Ra face finish	25.9 (657)	54 (24)
A35	2 in	CL900/1 500	ASME B16.5	F316/F316L	Weld neck flange	Raised face	27.4 (695)	83 (38)
A36	3 in	CL150	ASME B16.5	F316/F316L	Weld neck flange	Raised face	25.3 (641)	60 (27)
A37	3 in	CL300	ASME B16.5	F316/F316L	Weld neck flange	Raised face	25.9 (657)	68 (61)
A38	3 in	CL600	ASME B16.5	F316/F316L	Weld neck flange	Raised face	26.6 (676)	75 (34)

Code	Description						Dim A in (mm)	Weight lb (kg)
A39	2 in	CL150	ASME B16.5	F316/F316L	Weld neck flange	Raised face 63-125 Ra face finish	24.8 (629)	50 (23)
A40	2 in	CL300	ASME B16.5	F316/F316L	Weld neck flange	Raised face 63-125 Ra face finish	25.3 (641)	53 (24)
A41	2 in	CL600	ASME B16.5	F316/F316L	Weld neck flange	Raised face 63-125 Ra face finish	26.18 (664)	57 (26)
A42	2 in	CL150	ASME B16.5	F316/F316L	Weld neck flange	RTJ face	25.3 (641)	51 (23)
A43	2 in	CL300	ASME B16.5	F316/F316L	Weld neck flange	RTJ face	26.0 (660)	55 (25)
A44	2 in	CL600	ASME B16.5	F316/F316L	Weld neck flange	RTJ face	26.3 (667)	58 (26)
A45	2 in	CL900/1 500	ASME B16.5	F316/F316L	Weld neck flange	RTJ face	27.5 (699)	84 (38)
B55	2 in	CL600	ASME B16.5	A105 Carbon Steel	Lap joint flange	316/316L stub	24.8 (629)	57 (26)
B85	50mm	10K	JIS B 2220	A105 Carbon Steel	Lap joint flange	316/316L stub	23.7 (602)	50 (23)
B86	50mm	20K	JIS B 2220	A105 Carbon Steel	Lap joint flange	316/316L stub	23.7 (602)	50 (23)
C75	DN40	PN40	EN 1092-1	F316/F316L	Weld neck flange	Type F	23.4 (595)	48 (22)
C76	DN50	PN40	EN 1092-1	F316/F316L	Weld neck flange	Type F	23.7 (629)	51 (23)

F200H

Code	Description						Dim A in (mm)	Weight lb (kg)
537	1.5 in	CL600	ASME B16.5	F304/F304L	Lap joint flange	N06022 stub	25.3 (641)	64 (29)
540	1.5 in	CL150	ASME B16.5	F304/F304L	Lap joint flange	N06022 stub	24.8 (628)	46 (21)
541	1.5 in	CL300	ASME B16.5	F304/F304L	Lap joint flange	N06022 stub	25.3 (641)	52 (23.5)
542	40mm	10K	JIS 2220	F304/F304L	Lap joint flange	N06022 stub	23.4 (595)	52 (23.5)
544	2 in	CL150	ASME B16.5	F304/F304L	Lap joint flange	N06022 stub	24.8 (628)	51 (23.5)
545	2 in	CL300	ASME B16.5	F304/F304L	Lap joint flange	N06022 stub	25.3 (641)	56 (25.5)

Code	Description						Dim A in (mm)	Weight lb (kg)
546	50mm	10K	JIS B 2220	F304/F304L	Lap joint flange	N06022 stub	23.7 (601)	55 (25)
548	DN40	PN40	EN 1092-1	F304/F304L	Lap joint flange	Type B1, N06022 stub	23.6 (599)	50 (23)
549	DN50	PN40	EN 1092-1	F304/F304L	Lap joint flange	Type B1, N06022 stub	23.8 (605)	56 (25.5)

F300S**Note**

DIM A are representative of case code option E.

Code	Description						Dim A in (mm)	Weight lb (kg)
326	DN80	PN40	EN 1092-1	F316/F316L	Weld neck flange	Type D	33.7 (856)	83 (38)
333	DN100	PN40	EN 1092-1	F316/F316L	Weld neck flange	Type D	34.2 (869)	111 (50)
355	3 in	CL150	ASME B16.5	F316/F316L	Weld neck flange	Raised face	34.6 (879)	104 (47)
356	3 in	CL300	ASME B16.5	F316/F316L	Weld neck flange	Raised face	35.4 (899)	113 (51)
357	3 in	CL600	ASME B16.5	F316/F316L	Weld neck flange	Raised face	36.1 (917)	119 (54)
358	3 in	CL900	ASME B16.5	F316/F316L	Weld neck flange	Raised face	37.6 (955)	123 (56)
359	DN100	PN100	EN 1092-1	F316/F316L	Weld neck flange	Type D	36.2 (919)	141 (64)
361	3 in		Tri-Clamp compatible	316L	Hygienic fitting		32.9 (836)	84 (38)
371	DN80	PN40	EN 1092-1	F316/F316L	Weld neck flange	Type B1	33.7 (856)	103 (47)
372	DN100	PN40	EN 1092-1	F316/F316L	Weld neck flange	Type B1	34.2 (869)	91 (41)
373	DN80	PN100	EN 1092-1	F316/F316L	Weld neck flange	Type B2	35.3 (897)	121 (55)
374	DN100	PN100	EN 1092-1	F316/F316L	Weld neck flange	Type B2	36.2 (919)	143 (65)
375	DN80	PN100	EN 1092-1	F316/F316L	Weld neck flange	Type D	35.3 (897)	119 (54)
391	DN80	PN40	DIN 2635	F316/F316L	Weld neck flange	Form C face	33.8 (859)	82 (37)
392	DN100	PN40	DIN 2635	F316/F316L	Weld neck flange	Form C face	34.2 (867)	92 (42)

Code	Description						Dim A in (mm)	Weight lb (kg)
393	DN80	PN40	DIN 2635	F316/F316L	Weld neck flange	Form N grooved face	33.8 (859)	103 (47)
394	DN100	PN40	DIN 2635	F316/F316L	Weld neck flange	Form N grooved face	34.2 (869)	111 (50)
395	DN80	PN100	DIN 2637	F316/F316L	Weld neck flange	Form E face	35.5 (902)	121 (55)
396	DN100	PN100	DIN 2637	F316/F316L	Weld neck flange	Form E face	36.5 (927)	141 (64)
397	DN80	PN100	DIN 2637	F316/F316L	Weld neck flange	Form N grooved face	35.5 (902)	121 (55)
398	DN100	PN100	DIN 2637	F316/F316L	Weld neck flange	Form N grooved face	36.5 (927)	140 (63)
400	80mm	10K	JIS B 2220	F316/F316L	Weld neck flange	Raised face	34.3 (871)	99 (45)
401	100mm	10K	JIS B 2220	F316/F316L	Weld neck flange	Raised face	34.5 (876)	103 (47)
402	80mm	20K	JIS B 2220	F316/F316L	Weld neck flange	Raised face	34.3 (871)	103 (47)
410	3 in		Grooved coupling	316L	Hygienic coupling		34.6 (879)	141 (64)
425	4 in	CL150	ASME B16.5	F316/F316L	Weld neck flange	Raised face	35.0 (889)	110 (50)
426	4 in	CL300	ASME B16.5	F316/F316L	Weld neck flange	Raised face	35.9 (912)	129 (59)
427	4 in	CL600	ASME B16.5	F316/F316L	Weld neck flange	Raised face	37.6 (955)	157 (71)
428	4 in	CL900	ASME B16.5	F316/F316L	Weld neck flange	Raised face	38.1 (968)	185 (84)

F300H**Note**

DIM A are representative of case code option E.

Code	Description						Dim A in (mm)	Weight lb (kg)
539	3 in	CL600	ASME B16.5	F304/F304L	Lap joint flange	N06022 stub	35.3 (897)	112 (50)
550	3 in	CL150	ASME B16.5	F304/F304L	Lap joint flange	N06022 stub	34.6 (878)	105 (48)
551	3 in	CL300	ASME B16.5	F304/F304L	Lap joint flange	N06022 stub	35.3 (897)	112 (50)

Code	Description						Dim A in (mm)	Weight lb (kg)
552	80mm	10K	JIS B 2220	F304/F304L	Lap joint flange	N06022 stub	34.3 (870)	99 (45)
554	DN80	PN40	EN 1092-1	F304/F304L	Lap joint flange	Type B1, N06022 stub	33.8 (858)	90 (41)

F400S

Code	Description						Dim A in (mm)	Weight lb (kg)
435	4 in	CL150	ASME B16.5	F316/F316L	Weld neck flange	Raised face	43.0 (1092)	147.4 (66.9)
436	4 in	CL300	ASME B16.5	F316/F316L	Weld neck flange	Raised face	43.8 (1113)	198.6 (90.1)
437	4 in	CL600	ASME B16.5	F316/F316L	Weld neck flange	Raised face	45.5 (1156)	223.7 (101.5)
443	DN100	PN40	EN 1092-1	F316/F316L	Weld neck flange	Type B1	42.1 (1069)	176.8 (80.2)
445	DN100	PN40	EN 1092-1	F316/F316L	Weld neck flange	Type B2	44.1 (1120)	176.8 (80.2)
447	DN100	PN100	EN 1092-1	F316/F316L	Weld neck flange	Type D	44.1 (1120)	205.1 (93.0)
470	100 mm	10K	JS B 2220	F316/F316L	Weld neck flange	Raised face	42.1 (1069)	147.4 (66.9)
472	100 mm	20K	JS B 2220	F316/F316L	Weld neck flange	Raised face	42.1 (1069)	147.4 (66.9)
480	DN100	PN40	EN 1092-1	F316/F316L	Weld neck flange	Type D	42.1 (1069)	176.3 (80.0)
A63	4 in	CL150	ASME B16.5	F316/F316L	Weld neck flange	Raised face 63-125 Ra face finish	43.0 (1092)	178.6 (81.0)
A64	4 in	CL300	ASME B16.5	F316/F316L	Weld neck flange	Raised face 63-125 Ra face finish	43.8 (1113)	198.6 (90.1)
A65	4 in	CL600	ASME B16.5	F316/F316L	Weld neck flange	Raised face 63-125 Ra face finish	45.5 (1156)	223.7 (101.5)
A72	4 in	CL150	ASME B16.5	F316/F316L	Weld neck flange	RTJ face	44.0 (1118)	181.9 (82.5)
A73	4 in	CL300	ASME B16.5	F316/F316L	Weld neck flange	RTJ face	44.7 (1135)	202.3 (91.8)
A74	4 in	CL600	ASME B16.5	F316/F316L	Weld neck flange	RTJ face	45.9 (1166)	225.3 (102.2)
B96	4 in	SCH40	ASME B36.19	316/316L	Pipe stub	V groove	49.0 (1245)	158.2 (71.8)

Code	Description						Dim A in (mm)	Weight lb (kg)
C78	DN100	PN40	EN 1092-1	F316/F316L	Weld neck flange	Type F	42.1 (1069)	175.8 (79.7)
E49	4 in		Victaulic compat	316L	Hygienic coupling		40.5 (1029)	150.2 (68.1)

NAMUR NE132 compliant flanges

Sensor	ETO#	Description						Dim A in (mm)	Weight lb (kg)
F025S999	13998	DN15	PN40	EN 1092-1	F316/F316L	Weld neck flange	Form B1	20.1 (510)	11.7 (5.8)
F050S999	20589	DN15	PN40	EN 1092-1	F316/F316L	Weld neck flange	Form B1	20.1 (510)	13.4 (6.1)
F050S999	17157	DN25	PN40	EN 1092-1	F316/F316L	Weld neck flange	Form B1	23.6 (600)	13.9 (6.3)
F100S999	13999	DN25	PN40	EN 1092-1	F316/F316L	Weld neck flange	Form B1	23.6 (600)	23.8 (11.3)
F200S999	14000	DN50	PN40	EN 1092-1	F316/F316L	Weld neck flange	Form B1	28.2 (715)	48.4 (22.9)
F300S999	17159	DN80	PN40	EN 1092-1	F316/F316L	Weld neck flange	Form B1	36.0 (915)	106 (48)
F300S999	17158	DN100	PN40	EN 1092-1	F316/F316L	Weld neck flange	Form B1	39.7 (1000)	116 (53)
F300S999	20590	DN100	PN16	EN 1092-1	F316/F316L	Weld neck flange	Form B1	39.7 (1000)	108 (49)

Emerson Automation Solutions

Worldwide Headquarters
7070 Winchester Circle
Boulder, Colorado USA 80301
T: +1 800-522-6277
T: +1 303-527-5200
F: +1 303-530-8459
Mexico: +52 55 5809 5300
Argentina: +54 11 4809 2700
Brazil: +55 15 3413 8000
Chile: +56 2 2928 4800
Peru: +51 15190130

Emerson Automation Solutions

Central Europe: +41 41 7686 111
Eastern Europe: +41 41 7686 111
Dubai: +971 4 811 8100
Abu Dhabi: +971 2 697 2000
Austria: +43 2236 607-0
France: +33 (0) 800 917 901
Germany: +49 (0) 2173 3348 0
Italy: +39 8008 77334
The Netherlands: +31 (0) 70 413 6666
Belgium: +32 2 716 77 11
Spain: 900 901 983
U.K. and Ireland: 0870 240 1978
Russian/CIS: +7 495 995 9559

Emerson Automation Solutions

Australia: (61) 3 9721 0200
China: (86) 21 2892 9000
India: (91) 22 6662 0566
Japan: +81-3-5769-6800
South Korea: (82) 31 8034 0000
Singapore: (65) 6 363 7766

©2020 Micro Motion, Inc. All rights reserved.

The Emerson logo is a trademark and service mark of Emerson Electric Co. Micro Motion, ELITE, ProLink, MVD and MVD Direct Connect marks are marks of one of the Emerson Automation Solutions family of companies. All other marks are property of their respective owners.